

Karakter ležišta i svojstva močvarne željezne rude na položaju Kalinovac - Hrastova greda: model za analizu eksploatacije i uporabe ruda u arheološkim razdobljima

Karavidović, Tena; Brenko, Tomislav

Source / Izvornik: **Prilozi Instituta za arheologiju u Zagrebu, 2022, 39, 219 - 261**

Journal article, Published version

Rad u časopisu, Objavljena verzija rada (izdavačev PDF)

<https://doi.org/10.33254/piaz.39.2.5>

Permanent link / Trajna poveznica: <https://urn.nsk.hr/urn:nbn:hr:291:305639>

Rights / Prava: [Attribution 3.0 Unported/Imenovanje 3.0](#)

Download date / Datum preuzimanja: **2025-04-01**



INSTITUT ZA
ARHEOLOGIJU

Repository / Repozitorij:

[RIARH - Repository of the Institute of archaeology](#)



UDK 902
ISSN 1330-0644
Vol. 39/2
ZAGREB, 2022.

PRILOZI

Instituta za arheologiju u Zagrebu

Pril. Inst. arheol. Zagrebu
Str./Pages 1–270, Zagreb, 2022.

**PRILOZI INSTITUTA ZA ARHEOLOGIJU
U ZAGREBU, 39/2/2022
STR./PAGES 1–270, ZAGREB, 2022.**

Izdavač / Publisher
INSTITUT ZA ARHEOLOGIJU
INSTITUTE OF ARCHAEOLOGY

Adresa uredništva /
Address of the editor's office
Institut za arheologiju / Institute of archaeology
HR-10000 Zagreb, Jurjevska ulica 15
Hrvatska / Croatia
Telefon / Phone ++385 / (0)1 61 50 250
Fax ++385(0)1 60 55 806
e-mail: urednistvo.prilozi@iarh.hr
<http://www.iarh.hr>

Glavni i odgovorni urednik / Editor in chief
Marko DIZDAR

Tehnički urednici / Technical editors
Marko DIZDAR
Katarina BOTIĆ

Uredništvo / Editorial board
Prapovijest / Prehistory:
Marko DIZDAR, Institut za arheologiju, Zagreb,
Hrvatska
Snježana VRDOLJAK, Institut za arheologiju, Zagreb,
Hrvatska
Viktória KISS, Hungarian Academy of Sciences,
Institute of Archaeology, Budapest, Hungary
Antika / Antiquities:
Goranka LIPOVAC VRKLJAN, Institut za arheologiju,
Zagreb, Hrvatska
Ivan RADMAN-LIVAJA, Arheološki muzej u Zagrebu,
Zagreb, Hrvatska
Srednji vijek i novi vijek / Middle Ages and Modern era:
Tajana SEKELJ IVANČAN, Institut za arheologiju,
Zagreb, Hrvatska
Katarina Katja PREDOVNIK, University of Ljubljana,
Faculty of Arts, Ljubljana, Slovenia
Natascha MEHLER, Eberhard Karls University of
Tübingen, Tübingen, Germany
Tatjana TKALČEC, Institut za arheologiju, Zagreb,
Hrvatska
Metodologija / Methodology
Predrag NOVAKOVIĆ, University of Ljubljana, Faculty
of Arts, Ljubljana, Slovenia

Izdavački savjet / Editorial advisory board
Dunja GLOGOVIĆ, Zagreb, Hrvatska
Ivor KARAVANIĆ, Sveučilište u Zagrebu, Filozofski
fakultet, Odsjek za arheologiju, Zagreb, Hrvatska
Kornelija MINICHREITER, Zagreb, Hrvatska
Alexander T. RUTTKAY, Nitra, Slovakia
Ivančica SCHRUNK, University of St. Thomas, St. Paul,
Minnesota, USA
Željko TOMIČIĆ, Hrvatska Akademija znanosti i
umjetnosti, Zagreb, Hrvatska
Ante UGLEŠIĆ, Sveučilište u Zadru, Odjel za
arheologiju, Zadar, Hrvatska

Prijevod na engleski / English translation
Tena KARAVIDOVIĆ, Tomislav KIŠ, Mia MARIJAN,
Petra NIKŠIĆ, Saba RISALUDDIN

Lektura / Language editor
Ivana MAJER, Marko DIZDAR (hrvatski jezik / Croatian)
Marko MARAS (engleski jezik / English)

Korektura / Proofreads
Katarina BOTIĆ

Grafičko oblikovanje / Graphic design
Umjetnička organizacija OAZA

Računalni slog / Layout
Hrvoje JAMBREK

Tisak / Printed by
PRINTERA GRUPA d.o.o., Sveta Nedelja

Naklada / Issued
400 primjeraka / 400 copies

Prilozi Instituta za arheologiju u Zagrebu indeksirani su u /
Prilozi Instituta za arheologiju u Zagrebu are indexed by:
DYABOLA – Sachkatalog der Bibliothek – Römisch-
Germanische Kommission des Deutschen
Archaeologischen Instituts, Frankfurt a. Main
Clarivate Analytics services – Web of Science Core
Collection
CNRS / INIST – Centre National de la Recherche
Scientifique / L'Institut de l'Information Scientifique et
Technique, Vandoeuvre-lès-Nancy
EBSCO – Information services, Ipswich
ERIH PLUS – European Reference Index for the
Humanities and Social Sciences, Norwegian
Directorate for Higher Education and Skills, Bergen
SciVerse Scopus – Elsevier, Amsterdam

E-izdanja. Publikacija je dostupna u digitalnom obliku i
otvorenom pristupu na
<https://hrcak.srce.hr/prilozi-iaz>
E-edition. The publication is available in digital and
open access form at
<https://hrcak.srce.hr/prilozi-iaz?lang=en>

DOI 10.33254

Ovaj rad licenciran je pod Creative Commons
Attribution By 4.0 međunarodnom licencom /
This work is licenced under a Creative Commons
Attribution By 4.0 International Licence



SADRŽAJ

CONTENTS

	Izvorni znanstveni radovi	Original scientific papers
5	TOMISLAV KIŠ Staroegipatska lopatičasta lutka iz Arheološkoga muzeja u Zagrebu	TOMISLAV KIŠ Ancient Egyptian paddle doll from the Archaeological Museum in Zagreb
21	MIA MARIJAN O kamenim gomilama otoka Šćedra	MIA MARIJAN On the Stone Mounds of the Island of Šćedro
73	ADNAN BUSULADŽIĆ Elementi antičkih pojasnih garnitura, konjske i druge vojne opreme iz muzejskih zbirki u Bosni i Hercegovini (izbor nalaza)	ADNAN BUSULADŽIĆ Parts of Roman belt sets, horse harness and other military equipment in museum collections in Bosnia and Herzegovina (a selection)
151	PETRA NIKŠIĆ Kasnoantički glazirani i neglazirani tarionici iz Verušeda i Lobora	PETRA NIKŠIĆ Late Antique glazed and non-glazed mortars from Verušed and Lobor
219	TENA KARAVIDOVIĆ TOMISLAV BRENKO Karakter ležišta i svojstva močvarne željezne rude na položaju Kalinovac – Hrastova greda: model za analizu eksploatacije i uporabe ruda u arheološkim razdobljima	TENA KARAVIDOVIĆ TOMISLAV BRENKO Nature of the deposit and properties of bog iron ore at the Kalinovac – Hrastova Greda: a model for the analysis of ore exploitation and use in archaeological periods
263	Guidelines for contributors	Upute autorima

**KARAKTER LEŽIŠTA I SVOJSTVA
MOČVARNE ŽELJEZNE RUDE NA POLOŽAJU
KALINOVAC – HRASTOVA GREDA: MODEL
ZA ANALIZU EKSPLOATACIJE I UPORABE
RUDA U ARHEOLOŠKIM RAZDOBLJIMA**
NATURE OF THE DEPOSIT AND PROPERTIES
OF BOG IRON ORE AT THE KALINOVAC –
HRASTOVA GREDA: A MODEL FOR THE
ANALYSIS OF ORE EXPLOITATION AND USE IN
ARCHAEOLOGICAL PERIODS

Izvorni znanstveni rad / antička – srednjovjekovna arheologija
Original scientific paper / Roman - medieval archaeology
UDK UDC 903:669(497.5 Kalinovac)"652/653"
Primljeno / Received: 22. 2. 2022. Prihvaćeno / Accepted: 17. 8. 2022.

TENA KARAVIDOVIĆ
Institut za arheologiju
Jurjevska ulica 15
HR-10000 Zagreb
tenakaravidovic@gmail.com

TOMISLAV BRENKO
Sveučilište u Zagrebu
Rudarsko-geološko-naftni fakultet
Pierottijeva 6
HR-10000 Zagreb
tomislav.brenko@rgn.hr

Temeljna sirovina za proizvodnju željeza tijekom kasne antike i ranoga srednjeg vijeka na prostoru Podravine bila je močvarna željezna ruda. Analiza rudnih ležišta i svojstava ruda može doprinjeti razumijevanju prirodnih mehanizama koji uvjetuju način eksploatacije i uporabu ruda u prošlosti. Međutim, ubikacija ležišta je izazovna zbog mogućnosti degradacije, potpunoga iskorištavanja te inhibicije obnove ili razvoja ležišta, prvenstveno uzrokovanih ljudskom aktivnošću i utjecajem na okoliš. U suvremenome krajoliku Podravine najviši potencijal za razvoj ležišta i jedino, djelomično razoreno ležište, ustanovljeno je na položaju Kalinovac – Hrastova greda 1 – 3. Na osnovi njegove analize izveden je model mehanizma formiranja, fizionomije i položaja ležišta u Podravini te je povedena rasprava o metodama eksploatacije kao i potencijanim prostorima pojave ležišta u odnosu na položaje arheoloških lokaliteta s tragovima proizvodnje željeza. U svrhu analize tehnološke iskorištivosti ruda sličnih svojstava iz arheološkoga konteksta, provedeno je eksperimentalno taljenje kalinovačke rude. Na osnovi rezultata objašnjavaju se čimbenici koji su mogli onemogućiti proizvodnju spužvastoga željeza. Potonje istraživanje ukazuje i na tehnološku prilagodbu u prošlosti, preradu ruda uvjetovanu prirodnim preduvjetima, prvenstveno promjenjivim svojstvima močvarnih željeznih ruda i karakterom ležišta. Pri analizi se koriste podaci dobiveni površinskim terenskim pregledom, geoarheološkim sondiranjem, geoprostornim analizama, eksperimentalnim testiranjem i mineraloškim (XRD) te kemijskim analizama (ICP – AES) uzoraka razvojnih faza rude i zgure dobivene kroz postupak eksperimentalnoga taljenja.

Ključne riječi: močvarna željezna ruda, proizvodnja željeza, kasna antika, rani srednji vijek, geoarheologija, eksperimentalna arheologija, geoprostorne analize

The fundamental raw material used for iron production in the Podravina region during Late Antiquity and the Early Middle Ages was the bog iron ore. Analysis of ore properties and deposits can contribute to the understanding of natural mechanisms that conditioned the exploitation and use of ores in the past. However, locating the deposits is challenging, due to the possibility of full exploitation, degradation and inhibited regeneration or development caused primarily by human activities and impact on the environment. In the modern landscape of Podravina, the Kalinovac – Hrastova Greda 1 – 3 position had the highest potential for ore development and the only, partially destroyed ore deposit. Based on its analysis, a model of the formation mechanism, physiognomy and deposit positioning in Podravina is proposed and methods of exploitation and the potential area of the deposit occurrence in relation to the positions of archaeological sites with iron production remains are discussed. To analyse the technological usability of ore samples with similar properties from the archaeological context, experimental testing of the smelting process was performed with the Kalinovac ore. Based on the results, the factors that could inhibit the production of iron blooms are explained. The latter research also implies a past technological adaptation, ore dressing conditioned by natural preconditions, primarily the variable properties of bog iron ores and the nature of the deposits. Data from surface field survey, geoarchaeological probing, geospatial analysis, experimental testing and mineralogical (XRD) and chemical analysis (ICP – AES) of samples of ore development stages and slag obtained through experimental smelting are used in the analysis.

Key words: bog iron ore, iron production, Late Antiquity, Early Middle Ages, geoarchaeology, experimental archaeology, geospatial analysis

UVOD

Površinski arheološki terenski pregledi širega prostora Podravine ukazali su da je na 167 položaja prisutna zgura nastala pri postupku taljenja željezne rude i/ili kovačkim postupcima (Kudelić et al. 2017; Valent et al. 2021) (karta 1). Arheološka iskopavanja provedena su na položajima na kojima je slijedom neinvazivnih arheoloških metoda istraživanja (terenski pregled i geofizika) pretpostavljen obim i karakter lokaliteta povezan uz aktivnosti proizvodnje željeza. Iskopavanja su provedena u nekoliko kampanja na položajima nedaleko sela Hlebine (Velike Hlebine i Dedanovice), Virje (Sušine i Volarski breg) te Kalinovac (Hrastova greda 1). Arheološki zapis na položajima nedaleko Virja i Hlebina ukazao je na postojanje organiziranih cjelina, radionica u kojima se spužvasto željezo aktivno proizvodilo tijekom kasne antike i ranoga srednjeg vijeka (Sekelj Ivančan, Karavidović 2021; Botić 2021). Makroskopska analiza (Karavidović 2021a) nalaza vezanih uz proizvodnju željeza s lokaliteta Kalinovac – Hrastova greda 1 pokazala je da se zgura može pripisati postupku taljenja željezne rude i proizvodnje spužvastoga željeza, ali i primarnome kovanju, postupku pročišćavanja spužvastoga željeza.

Proizvodnja željeza uvelike se oslanja na mogućnost eksploatacije ili nabave prirodnih resursa, u prvome redu rude i drveta, odnosno drvenoga ugljena. Unutar arheološkoga konteksta istraženih radionica, ali i istovremenih naseobinskih struktura pronađeni su uzorci močvarnih željeznih ruda (Karavidović 2020; Brenko et al. 2021) koji svjedoče o karakteru temeljne sirovine iskorištavane tijekom kasne antike i ranoga srednjeg vijeka u svrhu proizvodnje željeza. Međutim, tek recentna istraživanja ukazala su na prisutnost i mogućnost formiranja močvarne željezne rude na prostoru Podravine (Sekelj Ivančan, Marković 2017; Brenko et al. 2020) (karta 1) te na genetsku, geokemijsku vezu između uzoraka prirodne i termički obrađene rude iz arheološkoga i geološkoga konteksta (Brenko et al. 2021). Potonja istraživanja podrazumijevala su geoarheološke površinske terenske preglede i uzorkovanje profila tla te detaljne mineraloške i geokemijske analize uzoraka ruda iz geološkoga i arheološkoga konteksta. Ekstenzivni arheološki terenski pregledi i geološka prospekcija rezultirali su pronalaskom površinskih i subpovršinskih tragova mogućih (neo)formacija močvarnih željeznih ruda, međutim, na cjelokupnome istraženom području Podravine samo

INTRODUCTION

Archaeological surface field surveys of the wider Podravina area indicated 167 positions with occurrences of slag that formed during the iron ore smelting or smithing processes (Kudelić et al. 2017; Valent et al. 2021) (Map 1). Archaeological excavations were carried out on positions where the extent and the character of the sites related to iron production activities were assumed based on non-invasive archaeological research (field survey and geophysics). Excavations were carried out in several campaigns at positions near the villages of Hlebine (Velike Hlebine and Dedanovice), Virje (Sušine and Volarski breg) and Kalinovac (Hrastova greda 1). Archaeological record at sites near Virje and Hlebine pointed to organized units, workshops where iron was produced actively during Late Antiquity and the Early Middle Ages (Sekelj Ivančan, Karavidović 2021; Botić 2021). Macroscopic analysis (Karavidović 2021a) of finds related to iron production from the Kalinovac – Hrastova greda 1 site showed that the slag can be attributed to the smelting of iron ore and the production of iron blooms but also primary smithing, the process of purifying iron blooms.

Iron production strongly relies on the possibility of exploitation or procurement of natural resources, primarily ore and wood (charcoal). Within the archaeological context of the analysed workshops and concurrent settlement structures, samples of bog iron ore (Karavidović 2020; Brenko et al. 2021) were found, which pointed to the character of the principal resource used for iron production during Late Antiquity and the Early Middle Ages. However, only recent research has indicated the presence and possibility of the formation of bog iron ore in the Podravina region (Sekelj Ivančan, Marković 2017; Brenko et al. 2020) (Map 1) and the genetic, geochemical link between natural and thermally treated ore samples from the archaeological and geological context (Brenko et al. 2021). The latter research included geoarchaeological surface field surveys and soil sampling and detailed mineralogical and geochemical analyses of ore samples from both geological and archaeological contexts. Extensive archaeological and geological field surveys resulted in the discovery of surface and subsurface traces of possible (neo)formations of bog iron ore. However, in the entire Podravina study area only at the Kalinovac – Hrastova greda 1–3 site all three development phases of bog iron ore and deposit in the initial environment/position were identified. Bog iron ore formation mechanism consists of three development phases or formation forms: a)

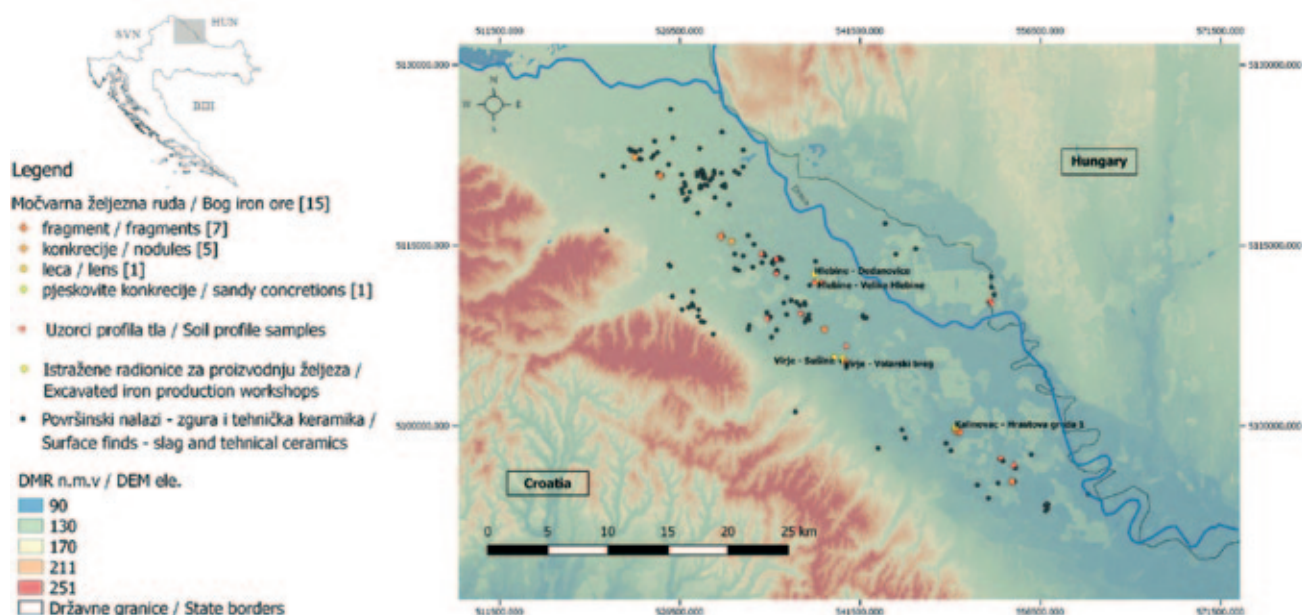

Karta 1 — Nizinski prostor Podravine s označenim položajima površinskih nalaza tragova proizvodnje željeza i močvarne željezne rude, bušotina profila tla te istraženih radionica za proizvodnju željeza (podloga: DMR 2020; izradila: T. Karavidović, 2021.)

Map 1 — Lowland area of Podravina with marked positions of surface finds of traces of iron production and bog iron ore, soil profile drillings and excavated workshops for iron production (base map data: DEM 2020; made by: T. Karavidović, 2021)

su na položaju Kalinovac – Hrastova greda 1 – 3 identificirane sve razvojne faze močvarne željezne rude i depozit u primarnome okruženju/položaju. Mehanizam formiranja močvarnih željeznih ruda podrazumijeva tri osnovne faze ili razvojne forme rude: a) početnu – meku formu u obliku tla obogaćenoga željezom; b) razvojnu – kugličaste tvorevine željezovitih oksihidroksida (konkrecije ili grumenje); c) razvijenu – čvrsti, u potpunosti formirani sloj rude (Thelemann et al. 2017; Kaczorek, Sommer 2003). Močvarne željezne rude su obnovljivoga karaktera, ali proces formacije izrazito je osjetljiv te ovisi o pogodnosti i stabilnosti prirodnih preduvjeta. Promjene okoliša uvjetovane ljudskim aktivnostima i klimatske promjene u odnosu na arheološka razdoblja mogu utjecati na mogućnost formiranja močvarne rude (Kaczorek, Sommer 2003: 400–401; Sitschick et al. 2005; Puttkammer 2012), ali i prepoznavanje te rekonstrukciju ležišta koja su bila eksploatirana u prošlosti. Ubikacija potencijalnih prostora razvoja ležišta te analiza značajki ležišta (mehanizam formiranja, fizionomija, obim, sastav rude) uvelike može doprinjeti istraživanju strategije eksploatacije i uporabe rude u prošlosti. S obzirom da su na položaju Kalinovac – Hrastova greda identi-

the initial phase – the soft form that represents Fe-enriched soil; b) the intermediate/transitional phase – nodular forms of Fe-oxyhydroxides (nodules or nuggets); c) developed phase – solid, fully formed layer of ore (Theleman et al. 2017; Kaczorek, Sommer 2003). Bog iron ores could regenerate, but the formation process is pronouncedly dependent on the conditions and stability of natural prerequisites needed for ore formation. Changes in the environment, driven by human activity and climate changes in relation to archaeological periods, can affect the possibility of bog iron ore formation (Kaczorek, Sommer 2003: 400–401; Sitschick et al. 2005; Puttkammer 2012), but also the recognition and reconstruction of deposits that have been exploited in the past. Ubication of potential areas of deposit formation and the analysis of the deposit character (formation mechanism, shape, size, ore composition) can significantly contribute to the research of exploitation strategies and the use of ore in the past. Since all development phases were identified on Kalinovac – Hrastova greda position, with it being the only currently known bog ore deposit in the Podravina, this paper aims to establish a development model for bog iron ores (in the modern landscape) of the Podravina region through a

ficirane sve razvojne faze i istraženo jedino do sada poznato ležište u Podravini, cilj ovoga rada je kroz studiju slučaja uspostaviti model razvoja močvarnih željeznih ruda (u suvremenome krajoliku) Podravine te definirati značajke ležišta u vezi s reljefnim, hidrološkim, pedološkim i geološkim preduvjetima razvoja kako bi se razumjeli prirodni, neizbježni mehanizmi koji su mogli uvjetovati eksploataciju i uporabu ruda u prošlosti. Analizom karakteristika i tehnološke iskoristivosti rude iz ležišta Kalinovac – Hrastova greda cilj je razumjeti obrazac pojave ruda sličnoga sastava u arheološkome kontekstu te definirati mogućnosti i način njihove uporabe u svrhu proizvodnje željeza tijekom kasne antike i ranoga srednjeg vijeka. Ciljevi se ostvaruju kroz:

1. analizu razvojnih faza, mehanizma formiranja i karakteristika močvarne željezne rude s položaja Kalinovac – Hrastova greda na osnovi makroskopske, mineraloške (XRD) i kemijske analize (ICP–AES);
2. analizu fizionomije ležišta i prostora potencijalne formacije rude u odnosu na reljefne, hidrološke, geološke i pedološke značajke;
3. analizu pogodnosti rude za proizvodnju spužvastoga željeza, eksperimentalnim testiranjem postupka taljenja primjenom tehnološkoga rješenja prisutnoga u arheološkim razdobljima te makroskopske, mineraloške i kemijske analize uzoraka zgure proizašle iz postupka;
4. usporedbu s referentnim arheološkim podacima o položajima istraženih lokaliteta s metalurškim značajkama te arheološkim nalazima močvarnih željeznih ruda sličnoga sastava iz razdoblja kasne antike i ranoga srednjeg vijeka.

METODOLOGIJA

Terenska istraživanja

Terenski pregledi položaja Kalinovac – Hrastova greda (karta 2) izvedeni su kroz više kampanja, s ciljem utvrđivanja položaja potencijalnih arheoloških lokaliteta i geoloških tvorevina koje bi se mogle dovesti u vezu s močvarnom željeznom rudom, temeljnom sirovinom za proizvodnju željeza na širem prostoru Podravine tijekom spomenutih arheoloških razdoblja. Položaj je poljoprivredno zemljište te se sustavno obrađuje.¹ Površinski nalazi ukazali su na prisutnost lokaliteta na kojemu su se odvijale

1 Višegodišnja obrada zemljišta i sadnja poljoprivrednih kultura vidljiva je iz satelitskih snimki od 2011. do 2021. godine pregledanih preko Google Earth platforme.

case study and to define the characteristics of the deposit concerning relief features, hydrological, pedological and geological prerequisites of development in order to understand the natural, inevitable mechanisms that could have conditioned the exploitation and the usage of ore in the past. By analysing the characteristics and technological usability of ore from the Kalinovac – Hrastova greda deposit, the aim is to understand the pattern of occurrence of ore samples with similar composition in archaeological contexts and to define the possibilities and manner of their use for iron production during Late Antiquity and the Early Middle Ages. The objectives are achieved through (1) analysis of development phases, formation mechanisms and characteristics of bog iron ore from the Kalinovac – Hrastova greda position based on macroscopic, mineralogical (XRD) and chemical (ICP–AES) analysis; (2) analysis of the physiognomy of deposits and area of potential ore formation in relation to relief, hydrological, geological and pedological characteristics; (3) analysis of ore usability for the production of bloomery iron by conducting experimental testing of the smelting process using a technological solution present in archaeological periods and macroscopic, mineralogical and chemical analysis of slag samples resulting from the smelting process; (4) comparison with reference archaeological data on the positions of investigated sites with proven metallurgical activity and archaeological finds of bog iron ore of similar composition, both dated to Late Antiquity and Early Middle Ages.

METHODOLOGY

Field research

Field surveys of the Kalinovac – Hrastova greda 1 – 3 position (Map 2) were carried out in several campaigns to determine the location of potential archaeological sites and geological occurrences that could be linked to bog iron ore, the fundamental raw material used for iron production in the broad area of Podravina during the aforementioned archaeological periods. The position is located on agricultural land, that is continuously cultivated.¹ Surface finds indicated the presence of a site where iron production activities took place (Valent et al. 2017: 17–18; 2021: Fig. 2; Karavidović 2021a). The area of the most inten-

1 Perennial tillage and planting of crops are visible from satellite images from 2011 to 2021 viewed via the Google Earth platform.

aktivnosti u vezi s proizvodnjom željeza (Valent et al. 2017: 17–18; 2021: Fig. 2; Karavidović 2021a). Područje najintenzivnije koncentracije površinskih nalaza snimljeno je geofizičkim metodama (Mušič et al. 2019) koje su dodatno potvrdile metalurški karakter lokaliteta i opseg podpovršinskoga arheološkog zapisa. Prostor na kojemu su pretpostavljeni tragovi metalurških aktivnosti djelomično je arheološki istražen u kampanji provedenoj 2019. godine (Sekelj Ivančan 2020). Izvan prostora pojave površinskih koncentracija zgre i pretpostavljenoga opsega podpovršinskoga arheološkog zapisa, tijekom površinskih terenskih pregleda otkrivene su geološke tvorevine koje ukazuju na visoku zasićenost tla željezom i mogućnost (neo)formacija močvarne željezne rude. Potonje podrazumijevaju koncentracije izrazitije crvenkastoga tla, konkrecije i fragmente pretpostavljene močvarne željezne rude te željezovite pedotvorevine. Na području visoke koncentracije većih

sive koncentracije površinskih nalaza analizirano je korištenjem geofizikalnih metoda (Mušič et al. 2019) što je dodatno potvrdilo metalurški karakter lokaliteta i opseg podzemnog arheološkog zapisa. Područje u kojem su tragovi metalurških aktivnosti djelomično arheološki istraženi u kampanji provedenoj 2019. godine (Sekelj Ivančan 2020). Osim površinskih nalaza slagova i pretpostavljene opsega podzemnog arheološkog zapisa, tijekom površinskih terenskih pregleda otkrivene su geološke tvorevine koje ukazuju na visoku zasićenost tla željezom i mogućnost (neo)formacija močvarne željezne rude. Potonje podrazumijevaju koncentracije izrazitije crvenkastoga tla, konkrecije i fragmente pretpostavljene močvarne željezne rude te željezovite pedotvorevine. Na području visoke koncentracije većih

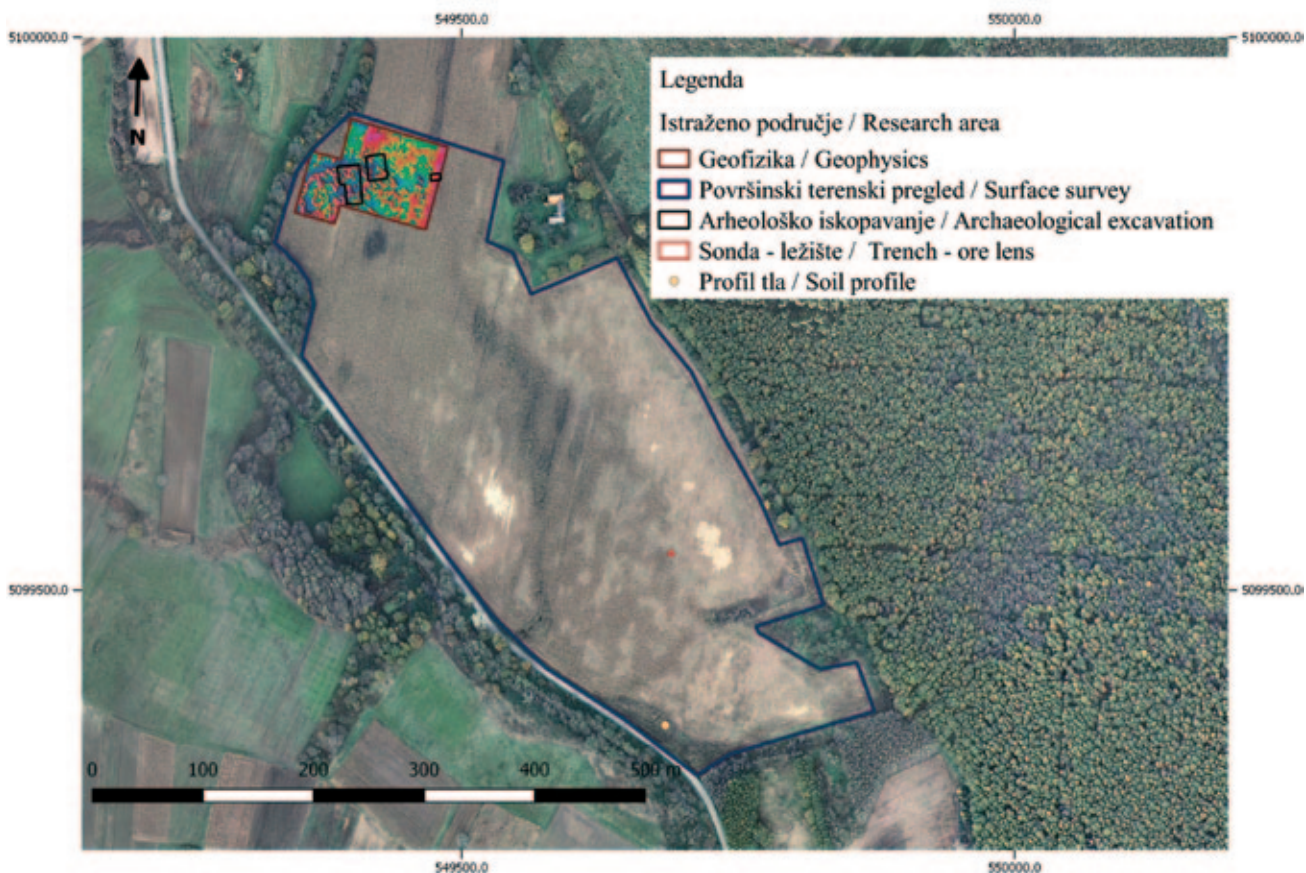

Karta 2 — Prostor obuhvata terenskih istraživanja na položaju Kalinovac – Hrastova greda (podloga: Digitalni ortofoto (DOF) 2018; izradila: T. Karavidović, 2021.)

Map 2 — Research area at Kalinovac – Hrastova greda position (background: Digital Orthophoto (DOF) 2018; made by: T. Karavidović, 2021)

fragmenata rude napravljena je probna sonda kako bi se definiralo potencijalno ležište koje je potom istraženo. Profil tla izbušen je auge-rom nedaleko položaja na kojima su bile vidljive površinske pojave izoranoga tla crvenkaste boje. Uzorci profila tla, konkrecija i fragmenata prikupljenoga iz ležišta te željezovitih pedotvorenina (pjeskovite konkrecije) analizirani su sa svrhom utvrđivanja mogućnosti (neo)formacija te karakteristika postojeće močvarne željezne rude.

Daljinska istraživanja: geoprostorne analize

Pozicije indikativnih geoloških tvorevina te položaj arheološkoga lokaliteta zabilježeni su tijekom terenskih istraživanja. U svrhu analize prostorne distribucije geoloških tvorevina i arheoloških nalaza u odnosu na reljefne značajke položaja Kalinovac – Hrastova greda izrađen je digitalni model reljefa. Podaci za generiranje digitalnoga modela reljefa prikupljeni su iz zračnih snimki putem programa Google Earth Pro. Za izradu modela korišten je softver Quantum GIS (QGIS 2.18), a primjenjena je Kriging metoda (*Simple kriging*) interpolacije točaka. Na osnovi digitalnoga modela reljefa izvedene su dodatne analize hidroloških i geomorfoloških značajki prostora proučavanja kako bi se jasnije razumjele okolnosti formacije močvarne rude, položaja i fizionomija ležišta. Potonje podrazumijevaju izračun i vizualizaciju topografskoga indeksa vlažnosti (*TWI – Topographic wetness index*) te izdvajanje zatvorenih depresija u krajoliku (*Closed Depression*) prema Wang i Liu (2006) te modulu Basic Terrain Analysis. Ove analize provedene su u softveru System for Automated Geoscientific Analyses (SAGA GIS 2.3.2), a vizualizacija je upotpunjena korištenjem QGIS 2.18. U svrhu izražavanja potencijala pojave ležišta unutar istraženoga prostora, površinski vidljive pojave faza razvoja močvarne željezne rude su kategorizirane prema odmaklosti razvoja (crveno tlo – konkrecije – fragmenti) te je izrađena vizualizacija prostorne zastupljenosti.

Eksperimentalno testiranje

U svrhu analize tehnološke iskoristivosti rude prikupljene iz ležišta i usporedbe s arheološkim nalazima rude sličnih svojstava, izvedeno

position where the surface occurrences of reddish soil were present. Following this, soil profile samples, nodules, fragments collected from the deposit and pedological features (sandy concretions) with suspected iron content were analysed to determine the possibility of (neo)formations and characteristics of existing bog iron ore.

Remote sensing: geospatial analyses

During field research, positions of indicative geological formations and the location of the archaeological site were recorded. To analyse the spatial distribution of geological formations and archaeological finds, in relation to the relief features of the Kalinovac – Hrastova greda area, a digital elevation model was created. Data for computing the model were collected from aerial images through Google Earth Pro. Quantum GIS software (QGIS 2.18) was used to create the model by applying the Kriging method (*Simple kriging*) of point interpolation. Based on the digital elevation model, additional analyses of the hydrological and geomorphological features in the study area were performed in order to understand more clearly the circumstances of the bog ore development, position and physical characteristics of the deposit. The latter included the calculation and visualization of the topographic wetness index (TWI) and determination of closed depressions in the landscape according to Wang and Liu (2006) and the Basic Terrain Analysis module. These analyses were carried out in the System for Automated Geoscientific Analyses (SAGA GIS 2.3.2) and the visualization was completed using QGIS 2.18. In order to express the potential for deposit formation within the explored area, stages of development of bog iron ore visible on the surface were categorized according to the development progress (red soil – nodules – fragments) and a visualization of spatial representation has been made.

Experimental testing

In order to analyse the technological usability of ore collected from the deposit and to compare it with archaeological finds of ore with similar characteristics, experimental testing of the smelting process was carried out, using the direct reduction, a method used during archaeological periods (Pleiner 2000: 131–137). The reconstructions of smelting furnaces are based on the ar-

je eksperimentalno testiranje talioničkoga postupka metodom direktne redukcije kakva je korištena tijekom arheoloških razdoblja (Pleiner 2000: 131–137). Osnovu za rekonstrukciju talioničkih peći čini arheološki zapis kao i nalazi s lokaliteta u okolini današnjeg sela Virje (Virje – Volarski breg i Sušine) i Hlebine (Velike Hlebine) na kojima su definirane radionice za proizvodnju spužvastoga željeza u sklopu kojih su pronađeni i tragovi talioničkih peći (Sekelj Ivančan, Karavidović 2021). U eksperimentu su korištene rekonstrukcije dviju samostojećih peći, s plicim (10 cm) i dubljim ognjištem (20 cm), a postupak taljenja izveden je jednom u svakoj peći (sl. 1). Tijekom postupka primjenjeni su operativni parametri (tab.1)² utemeljeni na prethodno izvedenim eksperimentalnim testiranjima u kojima je postupak taljenja uspješno izveden koristeći isti tip rude, močvarnu željeznu rudu (Karavidović 2020). U oba eksperimentalna testiranja taljena je ruda prikupljena iz istraženoga ležišta, termički

archaeological record and finds from the sites near the present-day villages of Virje (Virje – Volarski breg and Sušine) and Hlebine (Velike Hlebine), where workshops for the production of bloom iron were defined and where traces of smelting furnaces were found (Sekelj Ivančan, Karavidović 2021). Reconstructions of two freestanding furnaces were used in the experiment, with shallower (10 cm) and deeper (20 cm) hearths (Fig. 1). The smelting process was conducted once in each furnace. Operational parameters (Tab. 1)² applied during the process were based on previously performed experimental tests in which the smelting process was successfully carried out using the same type of ore, bog iron ore (Karavidović 2020). In both experiments, the ore smelted was collected from the investigated deposit, thermally processed (roasted) on an open fire and crushed into smaller fragments (Tab. 1). During the procedure, the temperatures were recorded on the outer furnace wall (position 1–4) and the furnace interior through the tuyeres (position 5), in the

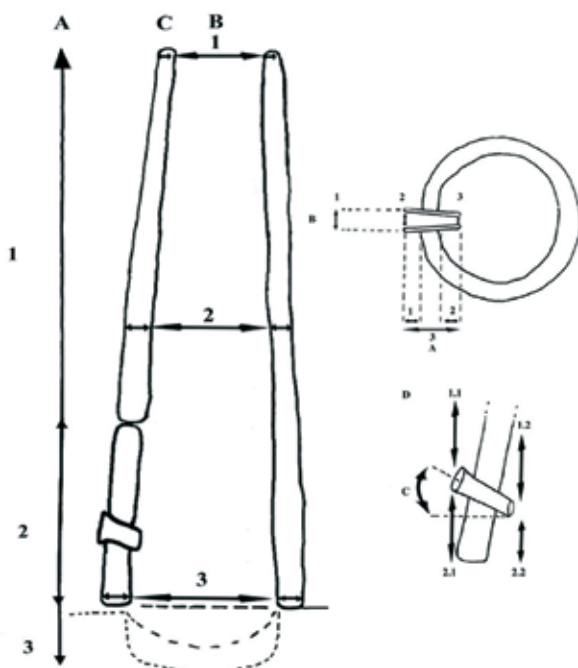

Dizajn peći - dimenzije / Furnace design - dimensions (cm / °)	Peć / Furnace			
	1	2		
Nadzemna konstrukcija i ognjište / Furnace construction and hearth	1+2	69,5	62	
	A	3	8–10	20
	2	25 x 26	no arch	
Stijenke peći / Furnace walls	1	16,5	17	
	B	24,5	20	
	3	35	25	
Sapnica / Tuyere	1	4,5	4–4,5	
	C	2	4,5	4–4,5
	3	5–6	5–5,5	
	1	7–8	7–8	
	A	2	2	
	3	13,5	13–13,5	
	1	7	6	
	B	2	4,5	4
	3	4,5	4	
	C	20°	20°	
	1.1	53,5	46	
	1.2	55,5	49	
	2.1	9	10	
2.2	17	37		

Sl. 1 — Dizajn i dimenzije peći 1 i 2 (izradila: T. Karavidović, 2021.)

Fig. 1 — Design and dimensions of furnaces 1 and 2 (made by: T. Karavidović, 2021)

2 Termin operativni parametri podrazumijeva skup parametara koji su primjenjeni tijekom postupka, a odnose se na način izvođenja postupka taljenja (omjer rude i ugljena, veličina mijeha i ritam upuhivanja zraka) te karakteristike ulaznih sirovina (vrsta pripreme – ispiranje, sušenje, prženje i granulacija/usitnjavanje rude te usitnjavanje, prosijavanje ugljena). Detaljnije o značaju strukturnih i operativnih parametara na ishod postupka taljenja: Karavidović 2021b.

2 The term operational parameters refer to a set of parameters applied during the process that relate to the way of performing the smelting process (ore-charcoal ratio, bellows size and air blowing rhythm) and characteristics of input materials (type of preparation – rinsing, drying, roasting and granulation/crushing of ores and crushing, sieving charcoal). For more details on the importance of structural and operational parameters on the outcome of the smelting process: Karavidović 2021b.

Eksperiment - Peć / Experiment - Furnace	Operativni parametri / Operational parameters					
	Ruda / Ore			Ugljen / Charcoal		
1 i 2 / 1 and 2	Vrsta / Type	Dimenzije / Dimensions	Priprema / Preparation	Vrsta / Type	Dimenzije / Dimensions	Priprema / Preparation
	fragmenti iz ležišta / deposit fragments	5 x 3 – 3 x 2 cm	pržena, usitnjena / roasted, crushed	bukva i grab / beech and hornbeam	5 x 3 / 2 – 2 x 2 cm	usitnjen / crushed
	Omjer ugljen : ruda / Ratio ore : charcoal	Zapremnina mijeha / Bellow capacity	Vrsta mijeha / Bellow type		Količina upuhnutog zraka / air input quantity	
	0,5 kg : 0,5kg	85 l	ručni - harmonika / hand operated - accordion		21,25 l/sek.	

Tab. 1 — Operativni parametri primjenjeni u eksperimentalnim testiranjima (izradila: T. Karavidović, 2021.)
Tab. 1 — Operating parameters applied in experimental testing (made by: T. Karavidović, 2021)

obrađena (pržena) na otvorenome ložištu te usitnjena na fragmente (tab. 1). Tijekom postupka zabilježene su temperature vanjske stijenke (položaj 1. – 4.) i unutrašnjosti peći, u zoni najviše postignute temperature, kroz sapnice (položaj 5.). Korišten je infracrveni pirometar (Volcraft IR 2200–50D) postavljen na $\varepsilon = 0,83$. Izmjerene temperature odnose se na maksimalne postignute temperature u točki mjerenja. Postupak je u cijelosti dokumentiran koristeći prethodno osmišljenu dokumentacijsku strategiju (prema: Karavidović 2021b).

Laboratorijske metode i analize

Uzorci tla, kongrecija i fragmenta rude (priklupljen iz ležišta), kao i zgure nastale eksperimentalnim postupkom taljenja analizirani su makroskopski, mineraloški i kemijski. Uzorci su usitnjeni na frakciju praha te im je određen mineralni sastav korištenjem rendgenske difrakcije na prahu (XRD). Za određivanje mineralnoga sastava korišten je Phillipsov vertikalni goniometar (vrste X'Pert) opremljen bakrenom cijevi i grafitnim monokromatorom. Prilikom mjerenja korišten je napon od 40 kV i struja jakosti 35 mA s veličinom koraka $0,02^\circ 2\theta$. Kemijske analize napravljene su u MSALabs (Langley, Kanada). Udio glavnih oksida određen je

zone of the maximum temperatures achieved. An infrared pyrometer (Volcraft IR 2200–50D), set to $\varepsilon = 0.83$, was used. The measured temperatures refer to the maximum temperatures reached at the measurement point. The procedure was fully documented using a previously designed documentation strategy (according to Karavidović 2021b).

Laboratory methods and analyses

Soil, nodule and ore fragment (collected from the deposit) as well as samples of slag formed during experimental smelting were analysed macroscopically, mineralogically and chemically. The samples were homogenized in a steel grinding set to powder fraction. Following this, the mineral composition was determined using X-ray powder diffraction (XRD). To determine the mineral composition, Phillips vertical goniometer (types X'Pert) equipped with copper tube and graphite monochromator was used. Measuring conditions included a voltage of 40 kV and a 35 mA current with a step size of $0.02^\circ 2\theta$. Chemical analyses were conducted at MSALabs (Langley, Canada). The composition of major oxides was determined using inductively coupled plasma with atomic emission spectrometry (ICP–AES) by using Liborate fusion. Contents of inorganic (TIC) and organic carbon (TOC) were determined by induc-

korištenjem induktivno spregnute plazme s atomskom emisijskom spektrometrijom (ICP–AES) uz fuziju Li–borata. Udjeli anorganskoga (TIC) i organskoga ugljika (TOC) određeni su indukcijom, dok je gubitak mase zagrijavanjem određen pri 1000 °C. Za uzorke zguure izračunat je indeks redukcije (RII) prema Charlton et al. (2010) kako bi se na teoretskoj razini procijenila učinkovitost postupka taljenja. Prethodno objavljeni mineraloški i geokemijski podaci uzoraka tla i konkrecija močvarne željezne rude (Brenko et al. 2020; 2021) koriste se za usporedbu razvojnih faza rude.

REZULTATI

Fizičke, mineraloške i geokemijske karakteristike uzoraka razvojnih faza močvarne željezne rude

Granulometrijska analiza profila tla na lokalitetu Kalinovac – Hrastova greda (sl. 2: a) pokazuje da se uzorak tla klasificira između ilovače i siltozne ilovače, dok je u njegovom najdubljem intervalu zastupljena pjeskovita ilovača. Makroskopska analiza profila tla pokazuje prisutnost željeza koje se očituje kao narančasto–smeđe taložine i prevlake na česticama tla, u vidu mekih mazotina. Boja intervala tla zasićenoga željezom očituje se kao narančasto – crvenkasta, a najveće koncentracije željeza zabilježene su na intervalu dubine 60 – 80 cm (sl. 2: b), što je potvrdila i mineraloška te geokemijska analiza (tab. 2–3: 1–2). Mineraloška analiza pokazuje pojavu getita (α -FeOOH) kao najzastupljenije mineralne faze, uz kvarc (SiO_2), u intervalu dubine od 60 do 100 cm. Usporedba vrijednosti koncentracije željezovih oksida (Fe_2O_3) između uzorkovanih profila tla s niza položaja na prostoru Podravine pokazuje da se najviše izmjerene vrijednosti nalaze upravo na uzorku tla s položaja Kalinovac – Hrastova greda (Brenko et al. 2020),³ a dosežu do 31,52 mas. % (interval dubine 60 – 80 cm). Interval dubine 60 – 100 cm zasićen getitom, odnosno s povišenim udjelima željezo (III) oksida može se dovesti u vezu s prvom razvojnom fazom močvarnih željeznih ruda, tzv. mekom, nestabilnom formom.

tion, while the loss on ignition was determined by heating to 1000°C. The reduction index (RII) was calculated after Charlton et al. (2010) for slag samples to assess the effectiveness of the smelting process on a theoretical level. Published mineralogical and geochemical data of bog iron ore soil and nodule samples (Brenko et al. 2020; 2021) are used to compare the ore development phases.

RESULTS

Physical, mineralogical and geochemical characteristics of bog iron ore developmental phases

Granulometric analysis of soil profile from Kalinovac – Hrastova greda (Fig. 2: a) shows that the sample is classified between loam and silty loam, while its deepest interval is classified as sandy loam. Macroscopic analysis of the soil profile shows the presence of iron, occurring as orange-brown mottles and coatings on soil particles in the form of soft masses. The colour of the soil interval saturated with iron manifests as orange to reddish, with the highest concentrations of iron recorded at the 60–80 cm depth interval (Fig. 2: b), which is confirmed by mineralogical and geochemical analyses (Tab. 2–3: 1–2). Mineralogical analysis indicates the appearance of goethite (α -FeOOH) as the most abundant mineral phase in addition to quartz (SiO_2) at the 60 to 100 cm depth interval. The comparison between the iron oxide (Fe_2O_3) content in the soil profiles, sampled from numerous locations in the Podravina region, indicated that the highest measured values are in the soil profile from the Kalinovac – Hrastova greda (Brenko et al. 2020),³ reaching up to 31.52 mass. % (depth interval 60–80 cm). The depth interval of 60–100 cm saturated with goethite and having the highest Fe_2O_3 content can be associated with the first development phase of the bog iron ores, the so-called soft, unstable form.

The nodules found on the ploughed surface are usually slightly irregularly globular, reddish to brown, with a diameter of 0.3–2 cm (Fig. 3: b; Tab. 2: 3). Nodules differ from the soils in

3 Geološka istraživanja karakteristika tala na prostoru Podravine koja su za cilj imala utvrđivanje mogućnosti formiranja močvarne željezne rude ukazuju da na položaju Kalinovac – Hrastova greda postoji najveća vjerojatnost (neo)formacije močvarnih željeznih ruda. Mikroskopski su analizirana 34 profila sa šireg područja Podravine, a dodatne geokemijske i mineraloške analize izvedene su na šest profila s najvećim potencijalom pojave znakova orudnjenja (Brenko et al. 2020).

3 Geological research of soil characteristics in the Podravina area, which aimed to determine the possibility of formation of bog iron ores, indicates that at the position Kalinovac – Hrastova greda, there is the highest probability of (neo)formation of bog iron ores. A total of 34 profiles from the wider Podravina area were macroscopically analysed, and additional geochemical and mineralogical analyses were performed on six profiles with the highest potential for the appearance of signs of mineralization (Brenko et al. 2020).

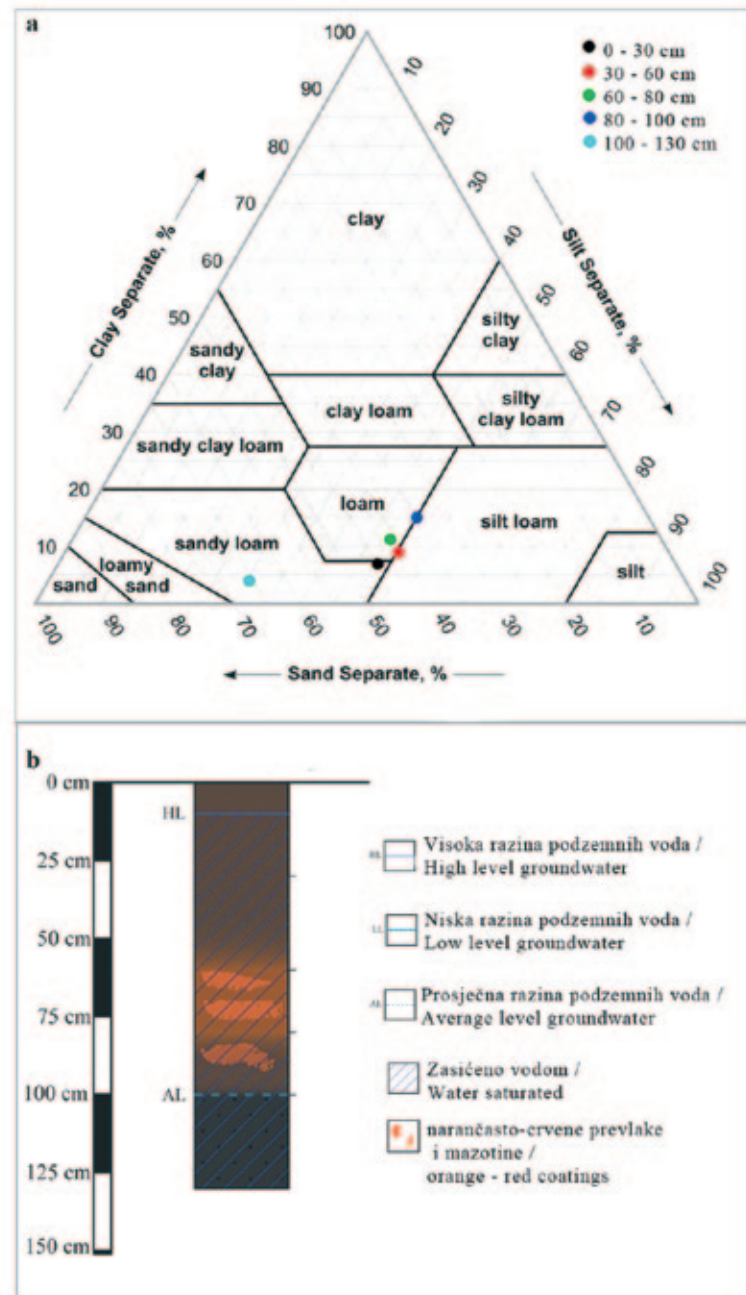

Sl. 2 — a) granulometrijska klasifikacija profila tla na lokalitetu Kalinovac – Hrastova greda, trokomponentni dijagram prema klasifikaciji Ministarstva poljoprivrede Sjedinjenih Američkih Država (USDA); b) shematski prikaz profila tla na položaju Kalinovac – Hrastova greda (modificirano prema: Brenko et al. 2020, Fig. 3) (izradili: T. Brenko i T. Karavidović, 2021.)

Fig. 2 — a) granulometric classification of the soil profile at the Kalinovac – Hrastova greda, three-component diagram according to the classification of the United States Department of Agriculture (USDA); b) schematic representation of the soil profile at the site Kalinovac – Hrastova greda (modified after Brenko et al. 2020, Fig. 3) (made by: T. Brenko and T. Karavidović, 2021)

Konkrecije pronađene na izoranoj površini uobičajeno su blago nepravilnoga globularnog oblika, promjera 0,3 – 2 cm, crvenkaste do smeđe boje, (sl. 3: b; tab. 2: 3). Konkrecije se ističu od tla unutar kojega su pronađene po svojoj tvr-

which they occur due to their hardness, which is associated with the advanced cementation process of Fe-oxyhydroxides (Brenko et al. 2021). Mineralogical analysis again indicates goethite as the main Fe phase, quartz and to

doći, što se može dovesti u vezu s uznapredovanim procesom cementacije Fe oksihidroksidima (Brenko et al. 2021). Mineraloška analiza ponovno ukazuje na getit kao glavnu željezovitu mineralnu fazu, kvarc te u manjoj mjeri na plagioklase i ortoklas kao tipične minerale tla (tab. 2: 3). Maseni udio Fe_2O_3 iznosi 36,02 mas. %, što je nešto više, no u najzasićenijem intervalu uzorka profila tla (tab. 3: 3). Ove geološke tvorevine mogu se dovesti u vezu s drugom razvojnom fazom močvarnih željeznih ruda, tzv. prijelaznom fazom.

Na prostoru površinske koncentracije fragmenata močvarne željezne rude iskopana je geoarheološka sonda s ciljem definiranja potencijalnoga ležišta. Na dubini 10 – 15 cm ispod površine otkriven je dio mehanički razorenoga ležišta s vidljivim tragovima pluga. Veći komadi močvarne rude (sl. 3) ležali su koncentrirani u rahlom, izoranom sloju, djelomično dislocirani od primarnoga depozita. Kako bi se dokumentirao ostatak potencijalnoga ležišta, iskopana je manja sonda do dubine od 100 cm. Ispod oranoga sloja (0 – 40/50 cm) bio je vidljiv tanji, neravnomjerno debeo sloj lećastoga presjeka (dubine 50 – 55/70 cm, 5 – 20 cm debljine) blago zasićen sitnim koncentracijama željezovitih nakupina, meke strukture i kuglastoga oblika. Ova tvorevina predstavlja dno depozita nad kojim je bio čvršće formirani sloj močvarne željezne rude razoren agrarnim aktivnostima i dubokim oranjem. Ispod potonjega sloja, nalazi se glinoviti, žuti sloj s vrlo sporadično vidljivim mekim kuglastim tvorevinama narančasto-crvene boje i sivo-plavičastim mikrozonama, a prostire se na dubini od oko 70 – 100 cm (najveća iskopana dubina). Fragmenti močvarne željezne rude makroskopski se mogu okarakterizirati kao konglomerat pojedinačnih globularnih konkrecija (sl. 3: d; tab. 2: 4). Boja konglomerata varira od oker do crvenkasto smeđe s tamnijim smeđim dijelovima. U uzorcima su vidljive nakupine pijeska i manjeg šljunka te tla/gline. Struktura je djelomično porozna, no ulomke odlikuje određena razina čvrstoće te su lomljivi tek pod jačim, mehaničkim pritiskom. Iz izgleda i položaja nakupine ulomaka razorenih oranjem moguće je zaključiti da se radilo o sloju čvršće formirane močvarne željezne rude debljine oko 15 – 20 cm. Iz ovoga depozita prikupljeno je oko 150 kg rude. Iako je otvorena sonda na širem području oko ostataka razorenoga ležišta, dodatni tragovi *in situ* depozita nisu prepoznati. Mineraloška analiza uzorka rude

a lesser extent plagioclase and orthoclase as typical soil minerals (Tab. 2: 3). Content of Fe_2O_3 reaches 36.02 mass. %, which is slightly higher than in the soil profile sample (Tab. 3: 3). These geological formations can be associated with the second development phase of bog iron ore, the so-called intermediate (transitional) phase.

A geoarchaeological probe was excavated in the area of surface concentration of bog iron ore fragments to define a potential deposit. Part of a mechanically destroyed deposit, with visible plough tracks, was discovered at 10–15 cm depth below the surface. Larger pieces of bog ore (Fig. 3) were lying concentrated in ploughed soil, partially separated from the primary place of deposit. In order to document the rest of the potential deposit, a 100 cm deep trench was excavated. Below the arable layer (0–40/50 cm), a thinner, unevenly thick layer of lenticular cross-section (50–55/70 cm deep, 5–20 cm thick) was noted and was slightly saturated with smaller concentrations of iron clusters with a soft structure and spherical shape. This layer represents the bottom part of the deposit overlaid by a more firmly formed layer of bog iron ore destroyed by agricultural activities and deep ploughing. Under the bottom layer, there was a clayey, yellowish layer with soft spherical formations of orange-red colour and grey-bluish microzones visible very sporadically, extending to a depth of about 70–100 cm (maximum excavated depth). Fragments of bog iron ore can be characterized macroscopically as a conglomerate of individual globular concretions (Fig. 3: d; Tab. 2: 4). The colour of the conglomerate varies from ochre to reddish-brown with darker brown parts. Accumulations of sand, gravel and soil/clay are visible in the samples. The structure is partially porous, but the fragments have a certain level of hardness and are brittle under harder mechanical pressure. Based on the appearance and position of the accumulated fragments destroyed by ploughing, it is possible to conclude that this represented a layer of more solidly formed bog iron ore, about 15–20 cm in thickness. Around 150 kg of ore was collected from the deposit. Although a trench was excavated in the wider area surrounding the debris of the destroyed deposit, additional traces of the *in situ* deposit were not found. Mineralogical analysis of the ore sample indicates a high goethite content, quartz and plagioclase, with occurrences of clay min-

ukazuje na najveću zastupljenost getita, kvarca i plagioklasa te minerala glina u tragovima (tab 2: 4). Geokemijska analiza glavnih oksida pokazuje udio Fe_2O_3 od 35,56 mas. % (tab. 3: 4). Zadnju razvojnu formu močvarnih željeznih ruda karakteriziraju masivni, čvrsti slojevi koji teku u kontinuitetu ili se javljaju isprekidano, čemu bi se prema strukturi i pojavi u tlu mogli pripisati fragmenti pronađeni na položaju Kalinovac – Hrastova greda.

Geokemijski, sva tri uzorka razvojnih faza imaju sastav tipičan za močvarne željezne rude: željezo

erals (Tab. 2: 4). Geochemical analysis of major oxides shows Fe_2O_3 contents of 35.56 mass. % (Tab. 3: 4). The final developmental form of bog iron ore is massive, solid continuous or intermittent layers (hard bog iron), to which fragments found at the Kalinovac – Hrastova greda position are attributed according to the structure and appearance in the soil.

Geochemically, all three samples of development phases have a composition typical of bog iron ores: iron (III) oxide (Fe_2O_3), silicon dioxide (SiO_2), manganese oxide (MnO), diphosphorus

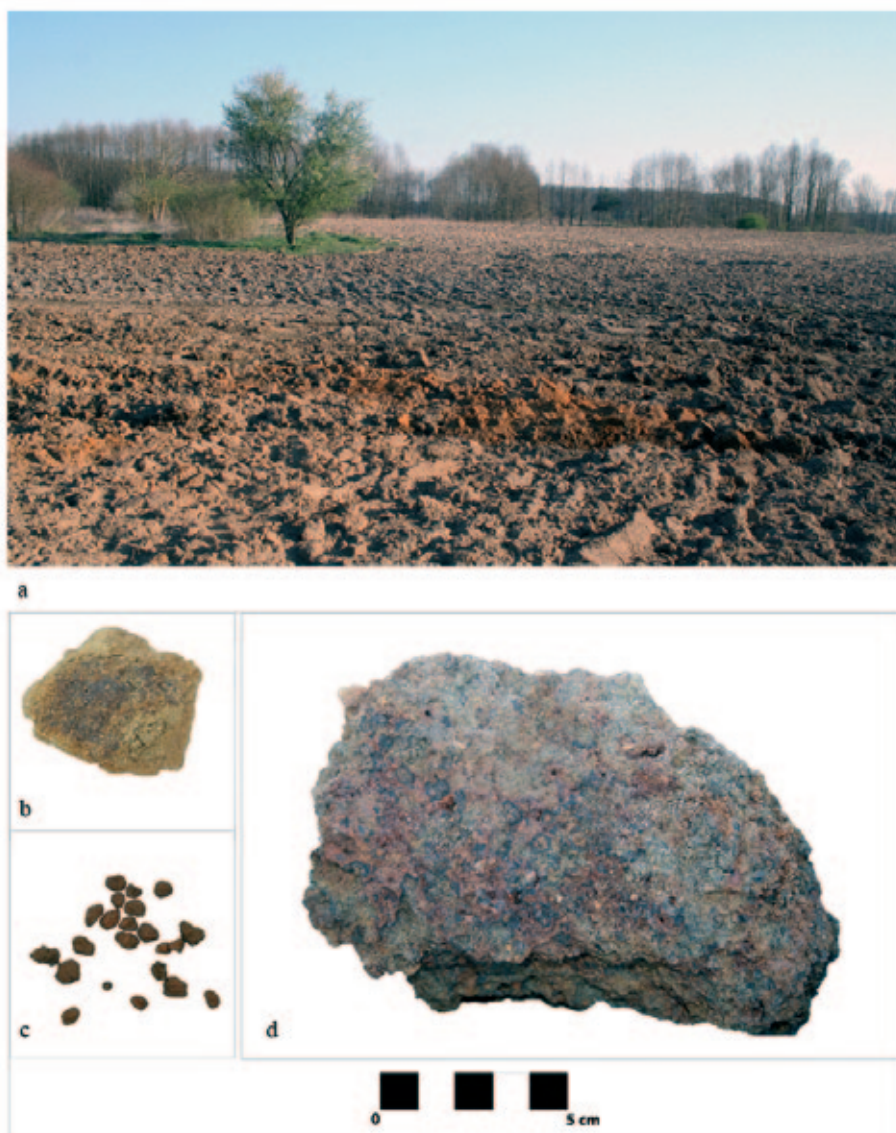

Sl. 3 — Indikativne tvorevine i močvarna željezna ruda: a) izorano tlo crvene boje; b) željezovita pedotvorevina – pjeskovita konkrecija s željezovitim matriksom (tab. 2: 5); c) globularne konkrecije – druga razvojna faza močvarne željezne rude (tab. 2: 3); d) grumen močvarne željezne rude prikupljen iz razorenog ležišta – treća razvojna faza (tab. 2: 4) (fotografija i digitalna obrada: T. Karavidović, 2021.)

Fig. 3 — Indicative formations and bog iron ore: a) red ploughed soil; b) sandy concretion with iron matrix (Tab. 2: 5); c) globular concretions (nodules) – second development phase of bog iron ore (Tab. 2: 3); d) fragment of bog iron ore collected from a destroyed deposit – third development phase (Tab. 2: 4) (photo and digital processing by: T. Karavidović, 2021)

Uzorak Sample	Faza razvoja močvarne rude Bog iron ore development phase	Boja Colour	Struktura Structure	Konzistencija Consistency	Qtz	Gt	PI	Or	CM	AM
1	tlo (dub. profila 80 – 100 cm) / soil (profile depth 80–100 cm)	naračasto – crvenkasto / orange – reddish	ilovasto tlo s narančasto-crvenim prevlakama i mazozelene mikrozone / loamy soil with orange-red coatings and bluish, grayish and greenish microzones	mekano s tvrdim praškastim mazotinama / soft with harder powderish coatings	+++	+	+		+	+
2	tlo (dub. profila 60 – 80 cm) / soil (profile depth 60–80 cm)	naračasto – crvenkasto / orange – reddish	ilovasto tlo s narančasto-crvenim prevlakama i mazozelene mikrozone / loamy soil with orange-red coatings	mekano s tvrdim praškastim mazotinama / soft with harder powderish coatings	++	++	+		?	+
3	konkreције / nodules	smeđe, crvenkasto / brown, reddish	hrapava vanjska površina, homogena masa, gusto / coarse outer surface, homogenous mass, dense	tvrd, lomljivo pod jačim pritiskom, rukom / hard, breakable under stronger pressure, by hand	+++	+	+	+	+	+
4	fragменти / fragments	oker, smeđe, crvenkasto, sivo – kapilarno / ochre, brown, reddish, gray – capillary	hrapava vanjska površina, heterogeni kompozit – globalne nakupine, glina, pijesak, šljunak sitni / coarse outer surface, heterogeneous – global accumulations, clay, sand, fine gravel composit	tvrd, lomljivo pod jačim pritiskom, rukom / hard, brittle under stronger pressure, by hand	+++	++	+	+	+	+
5	pieskovita konkreција s željezovitim matriksom / sandy concretion with Fe cementation zone	vanjšina – oker, presjek – tamno sivo, smeđe / exterior – ochre, cross-section – dark gray, brown	hrpavi sloj pijeskovite okerine, središte – nepravilna homogena nakupina / coarse layer of sandy crust, center – irregular homogenous clump	lomljivo pod jačim mehaničkim pritiskom, mrvi se okerinski dio / brittle under stronger mechanical pressure, the crust crumbles easily	+++	+	+	+		

Tab. 2. – Fizička obilježja i rezultati mineraloške analize uzoraka razvojnih faza močvarne željezne rude (XRD). + – relativni sadržaj minerala (kvantitativna vrijednost nije pridružena); +++ glavna komponenta; ++ sporedna komponenta; + komponenta u tragovima (izradila: T. Karavidović, 2021.)

Tab. 2 – Physical properties and results of mineralogical analysis of bog iron ore development phases samples (XRD). + – relative mineral content (quantitative value not associated); +++ main component; ++ secondary component; + trace component (made by: T. Karavidović, 2021)

Uzorak Sample	Faza razvoja močvarne rude Bog iron ore development phase	SiO ₂	TiO ₂	Al ₂ O ₃	Fe ₂ O ₃	MgO	MnO	CaO	K ₂ O	Na ₂ O	P ₂ O ₅	BaO	Cr ₂ O ₃	LOI	TIC	TOC	Total
1	tlo / soil	63,38	0,44	7,34	14,43	0,67	0,1	0,83	0,92	0,97	0,38	0,03	0,02	9,03	0,04	0,64	98,52
2	tlo / soil	50,75	0,38	6,82	27,93	0,68	0,31	0,83	0,85	0,9	0,31	0,04	0,02	9,27	0,04	0,66	99,07
3	konkreција / nodule	38,46	0,32	5,67	36,02	0,47	2,89	0,72	0,72	0,69	0,54	0,3	0,04	11,49	0,03	0,61	98,3
4	fragment / fragment	43,26	0,27	5,05	35,56	0,49	1,54	0,72	0,64	0,55	0,93	0,14	<0,01	11,74	/	/	100,91

Tab. 3 — Rezultati kemijske analize uzoraka razvojnih faza rude (ICP – AES). Vrijednosti izražene u postocima (% mass.) za okside, TIC, TOC (izradila: T. Karavidović, 2021.)
 Tab. 3 — Results of chemical analysis of ore development phase samples (ICP – AES). Values expressed in percentages (mass. %) for oxides, TIC, TOC (made by: T. Karavidović, 2021)

(III) oksid (Fe_2O_3), silicij dioksid (SiO_2), manganov oksid (MnO), difosforov pentoksid (P_2O_5), kalcijev karbonat (CaCO_3) i oksid (CaO), natrijevi spojevi i voda (H_2O) te elemente u nižim koncentracijama (aluminij (Al_2O_3), kalij (K_2O), barij (BaO), magnezij (MgO) i natrij oksid (Na_2O), titan – dioksid (TiO_2) te ukupni organski ugljik (TOC) i ukupni anorganski ugljik (TIC).

Pri terenskome pregledu prikupljeni su i uzorci amorfni prirodnih tvorevina čija je vanjska površina pjeskovite strukture, a unutrašnjost crvenkasto-crna i kompaktna, relativno porozna, no bez naznaka kugličastih tvorevina u strukturi (sl. 3: b; tab. 2: 5). Mineraloški, ove pedotvorenine karakterizira nizak udio getita te visok udio kvarca (tab. 2: 5). U tragovima se pojavljuju minerali gline (ilit) i minerali iz skupine feldspata/plagioklasa. Ove nakupine u sastavu sadržavaju getit tipičan za močvarne željezne rude, no u značajno manjoj količini nego uzorci konkrecija i fragmenata definirani kao razvojne faze močvarne željezne rude.⁴

PROSTORNA DISTRIBUCIJA GEOLOŠKIH TVOREVINA I POLOŽAJ ARHEOLOŠKOGA LOKALITETA

Površinski nalazi geoloških tvorevina koje označavaju faze razvoja močvarne željezne rude i istraženo ležište nalaze se u plitkim potolinama (karta 3: a). Uzorci željezovitih pedotvorenina pronađeni su na padini blagoga pjeskovitog uzvišenja. Pojedine mikrolokacije unutar depresija pokazuju veći intenzitet površinske pojave razvijenijih faza formacije rude (karta 3: b). Arheološki lokalitet metalurškoga karaktera, čiji je položaj i obim definiran kroz površinski terenski pregled, geofizička istraživanja i iskopavanja, rasprostire se po ocjeditom uzvišenju, niskoj pjeskovitoj gredi (karta 3: a). Topografski indeks vlažnosti (TWI) pokazuje da je na prostoru niskih potolina moguće očekivati izrazitiju zasićenost vlagom (karta 3: c). U reljefu položaja Kalinovac – Hrastova greda nalazi se više zatvorenih depresija sličnih dubina i različita obima (karta 3: d). Potonje su ujedno prostori s najvišim indeksom vlažnosti.

⁴ Ove tvorenine nisu cjelovito geokemijski analizirane, ali je napravljena analiza udjela Fe (180862 ppm = 18,086 % mass. Fe = 25,86 % mass. Fe_2O_3). Iz mineraloškoga i geokemijskoga sastava vidljiva je jasna razlika u zastupljenosti željeza naspram uzoraka fragmenata močvarne rude prikupljenih iz ležišta.

pentoxide (P_2O_5), calcium carbonate (CaCO_3) and oxide (CaO), sodium compounds and water (H_2O) and elements in lower concentrations (aluminium (Al_2O_3), potassium (K_2O), barium (BaO), magnesium (MgO) and sodium oxide (Na_2O), titanium dioxide (TiO_2) and total organic carbon (TOC) and total inorganic carbon (TIC).

During field surveys, samples of amorphous, natural formations with outer sandy surface and a compact reddish-black interior, relatively porous but without any indications of nodular-shaped formations in the structure were also collected (Fig. 3: b; Tab. 2: 5). Mineralogically, these pedological features are characterized by a low goethite content and a high content of quartz (Tab. 2: 5). Clay minerals (illite) and minerals from the feldspar/plagioclase group also occur in trace amounts. The features contain goethite, typical for bog iron ores, but in significantly lower quantities than the samples of nodules and fragments defined as the development phases of bog iron ore.⁴

SPATIAL DISTRIBUTION OF GEOLOGICAL FORMATIONS AND THE ARCHAEOLOGICAL SITE POSITIONING

Surface finds of geological formations denoting the development phases of bog iron ore and the explored deposit are found in shallow depressions (Map 3: a), while samples of pedological features with iron content are found on a slope of a slight sandy elevation. Some micro-locations within the depressions show a higher intensity of surface occurrences of more developed phases of ore formation (Map 3: b). The archaeological site, whose position and extent was defined by surface field surveys, geophysical investigations and excavations, is located over a drained, slightly elevated area, the sandy ridge (Map 3: a). The Topographic Wetness Index (TWI) shows that it is possible to expect more pronounced soil moisture in the shallow depressions (Map 3: c). In the relief of the Kalinovac – Hrastova greda area, there are several closed depressions with similar depths and of different volumes (Map 3: d). They represent zones with the highest wetness index.

⁴ These formations were not completely geochemically analysed but for the Fe content (180862 ppm = 18.086% mass. Fe = 25.86% mass Fe_2O_3). Mineral and geochemical composition show a clear difference in the presence of iron compared to samples of bog ore fragments collected from deposits.

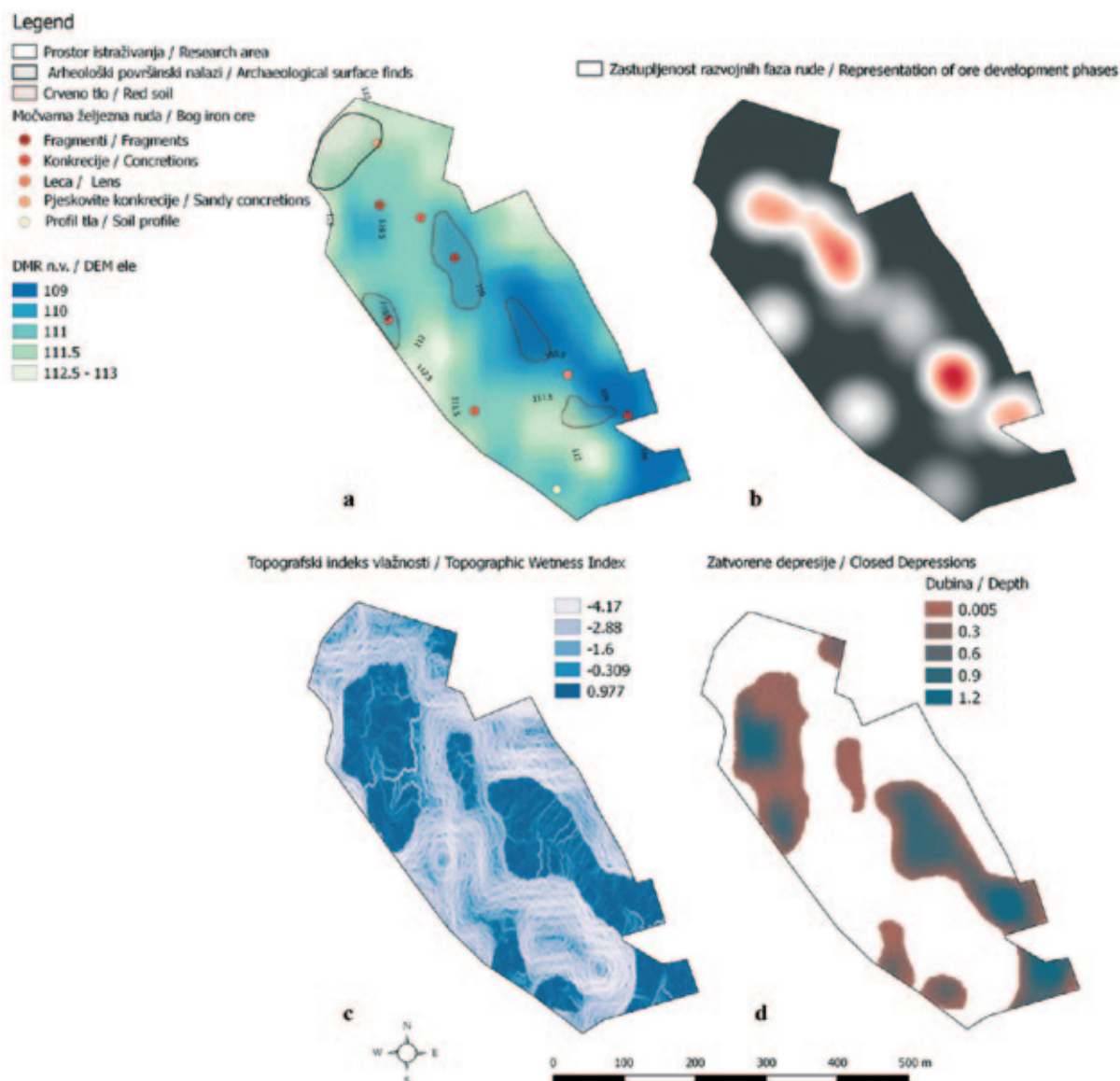

Karta 3 — a) prostorna distribucija geoloških tvorevina i položaj arheološkoga lokaliteta u odnosu na reljefne značajke položaja Kalinovac – Hrastova greda; b) intenzitet pojave indicativnih geoloških tvorevina, kategorizacija prema fazi razvoja; c) vizualizacija topografskoga indeksa vlažnosti; d) vizualizacija zatvorenih depresija (izradila: T. Karavidović, 2021.)

Map 3 — a) spatial distribution of geological formations and position of the archaeological site in relation to relief features of Kalinovac – Hrastova greda position; b) intensity of occurrence of indicative geological formations, categorization according to development phase; c) visualization of topographic wetness index; d) visualization of closed depressions (made by: T. Karavidović, 2021)

Eksperimentalno taljenje: proces direktne redukcije

Tijek postupaka

Priprema za postupak taljenja podrazumijevala je izgradnju i sušenje peći (prirodno tijekom noći (Peć 1) i inducirano – paljenjem vatre unutar ložišta (Peć 2)). Postupak taljenja podrazumijeva dva osnovna stadija: 1) zagrijavanje peći (umetanje ugljena – puna zapremnina

Experimental smelting: direct reduction process

The course of the procedure

Preparation for the smelting process included the construction and drying of the smelting furnace (naturally over the night (Furnace 1) and induced – by lighting a fire inside the furnace hearth (Furnace 2)). The smelting process implies two elemental stages: 1) preheating the furnace

peći); 2) direktna redukcija: a) postupno, naizmjenično zapunjavanje rudom i ugljenom; b) zapunjavanje ugljenom (produžena redukcija) i sagorijevanje ili sagorijevanje preostalog ugljena i redukcija zadnjih mjerica rude. Tijekom postupaka zagrijavanja i taljenja u obje peći upuhivan je zrak pomoću mijeha. Korišten je tzv. harmonika tip mijeha, zapune 85 litara, koji se u potpunosti punio zrakom prije svakoga upuha. Pojedini upuh trajao je 4 sekunde (kontinuirani jednoličan protok zraka, 21,25 litara zraka/1 sek.) i jedna sekunda za-

(charcoal insertion – entire furnace volume); 2) direct reduction: a) gradual, alternating charging with ore and charcoal; b) charging and combustion of charcoal (extended reduction) or combustion of residual charcoal and the reduction of the last ore charges. The air was introduced using a bellow, during the preheating and smelting procedure in both furnaces. The so-called accordion type of bellows, filled with air before each blow, with a volume of 85 litres, was used. Each blow into the system lasted 4 seconds (continuous uniform airflow, 21.25 litres of air/1 sec.) and

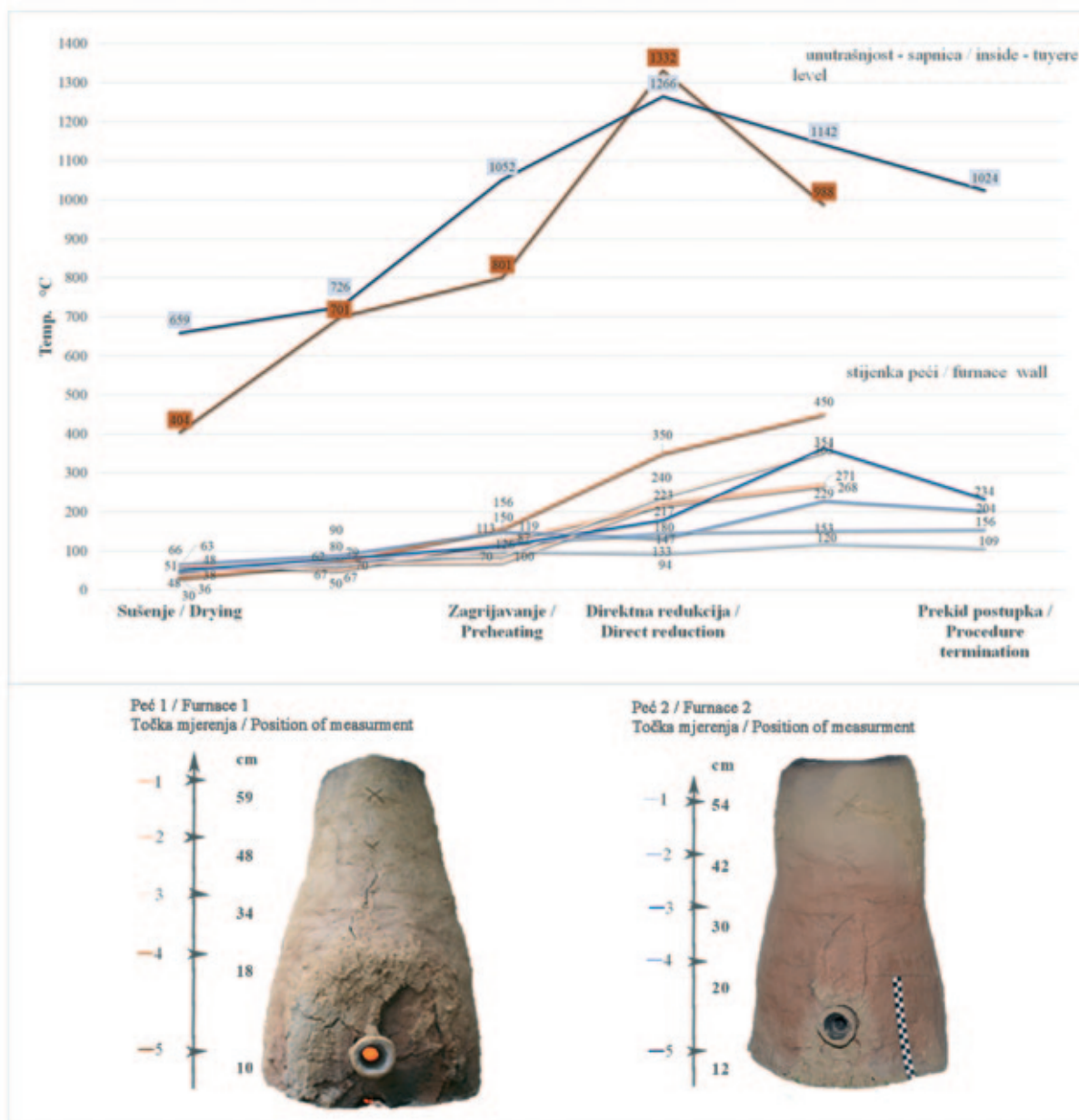

Sl. 4 — Temperaturni režim tijekom postupka sušenja, zagrijavanja i direktne redukcije. Peć 1 i 2 (izradila: T. Karavidović, 2021.)

Fig. 4 — Temperature regime during the process of drying, preheating and direct reduction, furnaces 1 and 2 (prepared by: T. Karavidović, 2021)

punjavanja volumena mijeha zrakom. Tijekom postupka direktne redukcije nastala zgura značajno je počela čepiti sapnicu u obje peći, gotovo u istome dijelu postupka redukcije (Stadij 2a), kada su prve mjerice rude i ugljena dosegle zonu najviših temperatura oko sapnice. Sapnicu se tijekom postupka mehanički odčepljivo željeznom šipkom, međutim, intenzitet nakupljena zgure bio je toliki da je gotovo cijelo vrijeme bilo potrebno čistiti otvor sapnice što je inhibiralo dotok zraka u sustav peći te posljedično sagorijevanje ugljena, održavanje temperature i redukcijske atmosfere, spuštanje rude niz okna i pravilnu redukciju. Iz istoga razloga postupak je u oba slučaja obustavljen nakon 1,04 sata (Peć 1) i 2,05 sata (Peć 2) od početka direktne redukcije. Utrošeno je ukupno 4 (Peć 1) i 5 kg (Peć 2) rude i ugljena. Temperaturni režim u obje peći, zabilježen kroz cijelo vrijeme trajanja postupka, pokazuje da su postignute temperature u peći do trenutka prekida bile pravilno vertikalno raspoređene (uzlazno pri spuštanju rude niz okno) te optimalne za redukciju rude (sl. 4). Nakon prekida postupka obje peći su otvorene kako bi se provjerilo stanje unutar peći i izdvojilo spužvasto željezo. Međutim, u oba slučaja spužvasto željezo se nije formiralo, već je sva sirovina koja je prošla proces rastaljena u zguru. U pećima je ostalo nedogorena ugljena uslijed prekida postupka, a kod eksperimenta u peći 2 zadnje mjerice rude ostale su nereducirane (na visini od oko 23 cm od razine otvora sapnice).

Fizičke, mineraloške i kemijske karakteristike zgure

Postupkom taljenja kalinovačke rude u obje se peći stvorila isključivo zgura, bez izdavanja spužvastoga željeza. Zgura je većinom bila zalijepljena uz stijenke peći vrata, koncentrirana oko djelomično začepljenih sapnica (sl. 5).

Nakupine zgure iz peći 1 i 2 morfološki su vrlo slične, a većinom su glatke površinske teksture, solidificirane u tekućem stanju. Mjestimično je vidljiva gruba, granulirana i hrapava površina, a zgura je u presjeku većinom izrazito porozna, tek mjestimično gušće nataložena. Boja zgure seže od svijetlo sivozelenkaste do tamno sive, a djelomično se pojavljuje i jarka tamno crvena boja. Za mineralošku i geokemijsku analizu prikupljen

one second of filling the volume of bellows with air. During the process of direct reduction, the resulting slag began to clog the tuyeres in both furnaces, almost during the same stage of the reduction process (Stage 2a), when the first ore and charcoal charges reached the zone of the highest temperatures, around the tuyere. The tuyere was unclogged mechanically with an iron rod during the procedure, but the intensity of slag accumulation was so high that it was necessary to clean the opening of the tuyere constantly, which inhibited the air supply to the furnace system and consequently the combustion of charcoal, temperature and reducing atmosphere maintenance, ore descent through the shaft and proper reduction. Due to this, the process was stopped after 1.04 hours (Furnace 1) and 2.05 hours (Furnace 2) from the start of the reduction process, in both experiments. A total of 4 (Furnace 1) and 5 kg (Furnace 2) of ore and charcoal were used during the process. The temperature regime in both furnaces, recorded during the procedures, indicates that the temperatures reached in the furnaces were properly vertically distributed (ascending when the ore was travelling down the shaft) and optimal for the ore reduction (Fig. 4). After terminating the procedure, both furnaces were opened to check the condition inside and extract the iron bloom. However, in both cases, iron bloom did not form and the ore that went through the process smelted to slag. Inside the furnaces, there were traces of unburned charcoal due to the interruption of the procedure, and in furnace 2, last ore charges remained unreduced (on a height of about 23 cm above the tuyere opening level).

Physical, mineralogical and chemical characteristics of slag

Smelting of the Kalinovac ore resulted only in slag formation in both furnaces, without iron bloom separation. The slag mostly adhered to the walls of the opening arch and concentrated around partially clogged tuyeres (Fig. 5).

The clusters of slag from furnaces 1 and 2 are morphologically very similar and have mostly smooth surface textures as a result of solidification from a liquid state. Occasionally, a rough, granulated and uneven surface is visible, with slag cross-section exhibiting porous texture, densely deposited in places. The slag colour ranges from light grey-greenish to dark grey, while the dark red colour appears sporadically. One indicative sample was taken for chemical and mineral

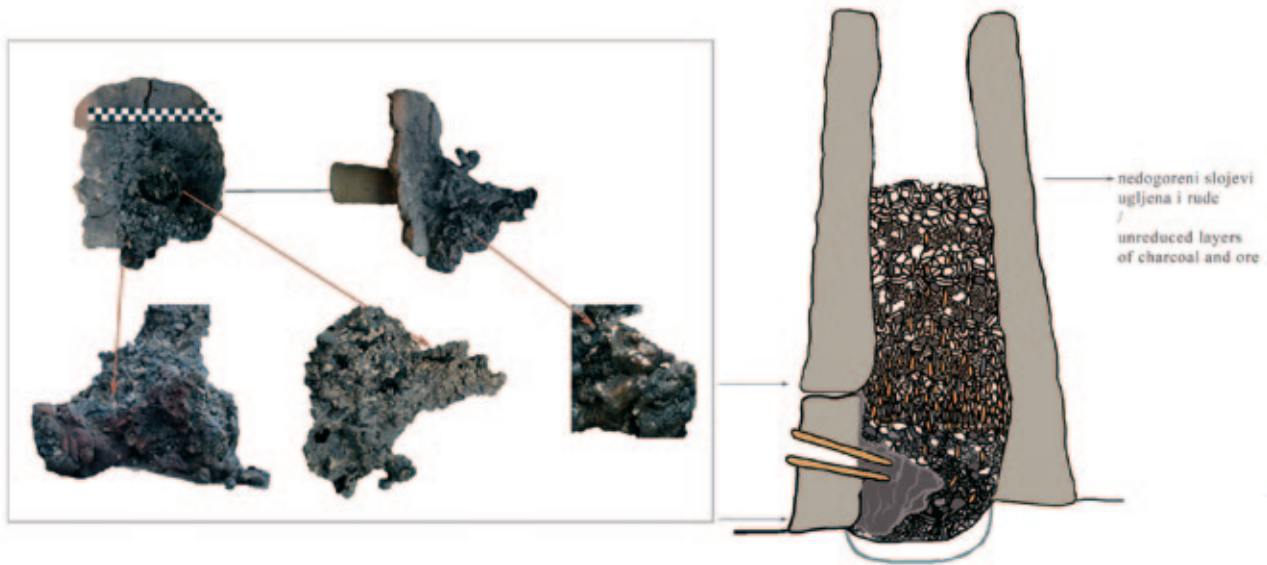

Sl. 5 — Peć 1: a) Vrata peći sa zalijepljenom zgurem, vidljiva tekstura i boje zgre; b) grafički prikaz situacije u peći neposredno prije prekida postupka (fotografija i grafički prikaz: T. Karavidović, 2021.)

Fig. 5 — Furnace 1: a) furnace door with adhering slag, visible texture and colours of slag; b) graphic representation of the situation in the furnace immediately before the termination of the smelting (photo and graphic representation: T. Karavidović, 2021)

je po jedan, indikativni uzorak iz svake peći. Položaj uzorkovanja zgre je relativno različit. Uzorak iz peći 1 prikupljen je neposredno ispod prostora sapnice, dok je kod peći 2 prikupljen iznad sapnice, u njejoj neposrednoj blizini. Uzorci su makroskopski zasebno opisani (tab. 4.).

U uzorku iz peći 1 (tab. 4: 6) prisutni su fajalit (Fe_2SiO_4) i kvarc kao glavne mineraloške komponente, dok se u tragovima pojavljuje i kristobalit. U uzorku iz peći 2 (tab. 4: 7) javljaju se fajalit i kvarc kao glavne komponente te hematit i magnetit kao i minerali skupine plagioklasa/feldspata. Kemijska analiza ukazuje da su kod oba uzorka najzastupljeniji spojevi SiO_2 i Fe_2O_3 , dok se ostali pojavljuju u manjoj količini, a slijedom zastupljenosti čine ih Al_2O_3 , MnO , CaO , K_2O , P_2O_5 , MgO , Na_2O , BaO , TiO_2 te SrO i Cr_2O_3 (tab. 5). Indeks redukcije željeza (Charlton et al. 2010: 356) iznosi 2,734 – 2,463.

analysis from each furnace. The sampling locations for slag were slightly different. The sample from furnace 1 was collected directly under the tuyere, while the sample from furnace 2 was collected above the tuyere, in its immediate vicinity. The samples are separately macroscopically described (Tab. 4).

In the sample from furnace 1 (Tab. 4: 6), fayalite (Fe_2SiO_4) and quartz are the main mineralogical components, while cristobalite appears as a trace component. The main components in slag from furnace 2 (Tab. 4: 7) are fayalite and quartz, occurring alongside hematite, magnetite and minerals of the plagioclase/feldspar group. Chemical analysis indicates that both samples mostly consist of SiO_2 and Fe_2O_3 , while other major oxides are present in minor quantities, in descending order from Al_2O_3 , MnO , CaO , K_2O , P_2O_5 , MgO , Na_2O , BaO , TiO_2 , SrO to Cr_2O_3 (Tab. 5). The Reducible Iron Index (RII), calculated according to Charlton et al. (2010: 356), is 2.734–2.463.

Uzorak / Sample	Peć br. / Furnace nr.	Boja / Colour	Tekstura površine / Surface texture	Struktura presjeka / Cross-section structure	Konzistencija / Consistency	Položaj uzorkovanja / Sample position	Fay	Qtz	Gt	Hem	Mag	Wue	Ostali minerali / Other minerals
6	peć 1 / furnace 1	tamno sivo, svijetlo sivo, okerzelenkasto / dark gray, light gray, ochre-greenish	glatka / smooth	porus / porozno	lomljivo rukom / breakable by hand	unutrašnjost peći, uz sapnicu (ispod) / furnace interior, by the tuyere (below)	+++	+++	-	-	-	-	Crs
7	peć 2 / furnace 2	tamno sivo, svijetlo sivo, oker, crveno / dark gray, light gray, ochre, red	glatka i mjestimično hrapavagr anulirana / smooth and in places rough-granulated	heterogeno-porozno, gusto / heterogeneous-porous, dense	mjestimično lomljivo rukom / partially breakable by hand	unutrašnjost peći, uz sapnicu (iznad) / furnace interior, by the tuyere (above)	+++	+++	-	++	++	-	Pl

Tab. 4 — Fizička obilježja i rezultati mineraloške analize uzoraka zgre (XRD). + – relativni sadržaj minerala (kvantitativna vrijednost nije pridružena); +++ glavna komponenta; ++ sporedna komponenta; + komponenta u tragovima (izradila: T. Karavidović, 2021.)

Tab. 4 — Physical properties and results of mineralogical analysis of slag samples (XRD). + – relative mineral content (quantitative value not associated); +++ main component; ++ secondary component; + trace component (made by: T. Karavidović, 2021)

Uzorak / Sample	SiO ₂	TiO ₂	Al ₂ O ₃	Fe ₂ O ₃	MgO	MnO	CaO	K ₂ O	Na ₂ O	P ₂ O ₅	BaO	Cr ₂ O ₃	LOI	Total	RII
6	44,79	0,32	6,33	40,58	0,83	2,64	2,85	1,24	0,66	0,92	0,24	0,02	-4,23	97,21	2,734
7	43,42	0,3	6,15	43,19	0,6	3,27	0,97	0,87	0,62	0,84	0,27	0,02	-3,35	97,19	2,445

Tab. 5 — Rezultati kemijske analize uzoraka zgre (ICP – AES) (izradila: T. Karavidović, 2021.)

Tab. 5 — Results of chemical analysis of slag samples (ICP – AES) (made by: T. Karavidović, 2021)

DISKUSIJA

Mehanizam formiranja i svojstva močvarne željezne rude

Močvarne željezne rude su sedimentni tip depozita koji se pojavljuje na nizinskim područjima okarakteriziranim s močvarama, livadama i riječnim dolinama kod kojih je razina podzemnih voda u neposrednoj blizini površine tla (Stoops 1983; Stanton et al. 2007: 693–694; Ramanaidou, Wells 2014). Riječ je o kopnenim naslagama željezovitih minerala, poglavito Fe oksida i hidroksida, a često se formiraju u hidromorfnim, ilovastim, pjeskovitim i glinovitim aluvijima i tlu (De Geyter et al. 1985; Landuydt 1990). Pogodno pedološko okruženje za formiranje ovoga tipa ruda čine glejna tla u asocijaciji s aluvijalnim pijescima (Kaczorek, Zagórski 2007) s promjenjivim redoks potencijalima i stalnim protokom vode obogaćene s Fe^{2+} ionima (Graupner 1982; Kaczorek et al. 2004). Prirodni preduvjeti na položaju Kalinovac – Hrastova greda, ali i u širem prostornom kontekstu područja Podravine, pogodni su za razvoj močvarnih željeznih ruda kakve su iskorištavane u prošlosti (Sekelj Ivančan, Marković 2017; Brenko et al. 2020; 2021).

Sastav močvarne željezne rude uvelike ovisi o kemijskom sastavu matičnoga supstrata, na što utječu geološki i hidrološki čimbenici te protok materijala zbog fluktuacije podzemnih voda. Mineralogija močvarnih željeznih ruda može biti raznolika zbog promjenjivih fizikalno-kemijskih uvjeta i redoks potencijala. Zbog sezonskih oscilacija visine podzemnih voda, u tlu se izmjenjuju vlažna i sušna razdoblja stvarajući oksidacijsku zonu u plićem intervalu profila tla, od 50 do 80 cm dubine, i redukcijsku zonu u dubljim dijelovima profila tla (Stoops 1983; Kaczorek, Sommer 2003). Močvarne rude prvenstveno se sastoje od amorfni i kristalnih Fe oksihidroksida (uglavnom getita, α - $FeOOH$),⁵ nastalih u oksidacijskim uvjetima te željeznih karbonata (siderit, $FeCO_3$), fosfata (vivianit, $Fe_3(PO_4)_2 \cdot 8H_2O$) i sulfata (pirit, FeS_2), nastalih u redukcijskim uvjetima (Stoops 1983; De Geyter et al. 1985; Banning 2008: 642; Werońska 2009: 30–34). Prisutnost getita kao glavne mineralne faze i izostanak sulfata, fos-

⁵ Močvarne željezne rude mogu sadržavati i željezne okside: hematit (Fe_2O_3) te magnetit (Fe_3O_4), što ovisi o izvorištu i uvjetima pri formiranju ruda (Banning 2008: 642).

DISCUSSION

The formation mechanism and properties of bog iron ore

Bog iron ores are a sedimentary type of deposits that occur in lowland areas characterized by wetlands, meadows and river valleys where the groundwater level is close to the soil surface (Stoops 1983; Stanton et al. 2007: 693–694; Ramanaidou, Wells 2014). These are terrestrial deposits of ferrous minerals, especially Fe oxides and hydroxides, and often form in hydromorphic, clayey, sandy, and clayey alluviums and soils (De Geyter et al. 1985; Landuydt 1990). A suitable pedological environment for the formation of this type of ore are gley soils in association with alluvial sands (Kaczorek, Zagórski 2007) with variable redox potentials and constant flow of groundwater-saturated with iron Fe^{2+} ions (Graupner 1982; Kaczorek et al. 2004). Environmental preconditions at the Kalinovac – Hrastova greda position, but also in the broader spatial context of the Podravina region, are favourable for the development of bog iron ores, such as ones exploited in the past (Sekelj Ivančan, Marković 2017; Brenko et al. 2020; 2021).

The composition of bog iron ore largely depends on the chemical composition of the parent substrate, which is influenced by geological and hydrological factors and the flow of materials due to groundwater fluctuations. The mineralogy of bog iron ores can be diverse due to changing physicochemical conditions and redox potentials. Because of the seasonal groundwater height oscillations, wet and dry periods alternate in the soil, creating an oxidation zone in the shallower soil profile interval, 50 to 80 cm deep, and a reduction zone in deeper parts of the soil profile (Stoops 1983; Kaczorek, Sommer 2003). Bog iron ores primarily consist of amorphous and crystalline Fe oxyhydroxides (mainly goethite, α - $FeOOH$),⁵ formed under oxidative conditions, and iron carbonates (siderite, $FeCO_3$), phosphate (vivianite, $Fe_3(PO_4)_2 \cdot 8H_2O$) and sulphate (pyrite, FeS_2), formed under reducing conditions (Stoops 1983; De Geyter et al. 1985; Banning 2008: 642; Werońska 2009: 30–34). The presence of goethite as the main mineral phase and the absence of iron carbonates, phosphates and sulphates in

⁵ Bog iron ores may also contain iron oxides: hematite (Fe_2O_3) and magnetite (Fe_3O_4), depending on the source and conditions of ore formation (Banning 2008: 642).

fata i piritu kod fragmenata i konkrecija rude s položaja Kalinovac – Hrastova greda svjedoči da su dominantni uvjeti pri formaciji rude oksidacijski. Prema analiziranom profilu tla ovakvi uvjeti najviše se ostvaruju u zoni od 60 do 80 cm dubine gdje je zasićenost getitom najveća, a vizualno je primjetna intenzivnija pojava narančasto-crvenih mazotina, znakova oksidacije željeza i promjenjivih redoks uvjeta uslijed oscilacije visine podzemnih voda (Husnjak 2014: 257).

Analiza sastava močvarnih ruda s prostora srednje i sjeverne Europe prisutnih u arheološkome kontekstu i izvan njega (Joosten et al. 1998: 132, Tab. 1; Joosten 2004: 116, 66, Tab. 13; Kaczorek, Sommer 2003: 396–397; Sitschick et al. 2005: 120–121, 124–125, Tab. 1; Thelemann et al. 2017: Tab 1; 4; Charlton et al. 2010: Tab. 3) pokazuje da zastupljenost Fe_2O_3 većinom varira između 35 i 50 % ukupne mase uzorka, no pojedini primjeri sadrže i znatno niže, ali i vrlo visoke udjele koji mogu doseći i oko 95 % ukupne mase. Maseni udio Fe_2O_3 kod uzorka rude izdvojene iz razorenoga depozita s položaja Kalinovac – Hrastova greda doseže 35,6 %, što ga svrstava na donju granicu udjela naspram analognih primjera s područja Europe te se može smatrati rudom lošije kvalitete u smislu tehnološke iskoristivosti, kako u suvremenoj proizvodnji željeza, tako i za tehnološka rješenja prisutna u arheološkim razdobljima. Potonji zaključak ne može se smatrati isključivim pravilom za rude s prostora Podravine, o čemu svjedoči širi raspon i varijabilnost udjela glavnih oksida kod oformljenih ruda i njihovih stadija razvoja pronađenih u arheološkome i/ili geološkome kontekstu kod kojih udjeli Fe_2O_3 sežu većinom od 37 do 49 % i rjeđe od 68 do 70 % (Brenko et al. 2020; 2021).⁶ Značajna varijabilnost udjela željeza u pojedinim rudama mogla bi se objasniti širokom prostornom distribucijom uspoređenih uzoraka te kompleksnim mehanizmima formiranja koji su izrazito ovisni o mikrookolišnim uvjetima u tlu, odnosno neposrednim okruženjem u kojemu se formira ruda. Formiranje ležišta močvarne željezne

samples of ore fragments and nodules from the Kalinovac – Hrastova greda position indicate that the prevailing conditions during ore development were oxidative. Based on the analysed soil profile, such conditions are achieved in the zone of 60 to 80 cm depth, where the saturation with goethite is highest. This is visually noticeable as a more intense presence of orange-red coatings, signs of iron oxidation and changing redox conditions, achieved through the oscillation of groundwater height (Husnjak 2014: 257).

Analysis of the composition of bog ores from Central and Northern Europe, present in the archaeological context and beyond (Joosten et al. 1998: 132, Tab. 1; Joosten 2004: 116, 66, Tab. 13; Kaczorek, Sommer 2003: 396–397; Sitschick et al. 2005: 120–121, 124–125, Tab.1; Theleman et al. 2017: Tab. 1; 4; Charlton et al. 2010: Tab. 3) shows that the Fe_2O_3 mostly varies between 35 and 50 mass. % in bog ores, but some can contain significantly lower but also very high contents that can reach up to 95% mass. The mass fraction of Fe_2O_3 in the ore sample extracted from the destroyed deposit at the Kalinovac – Hrastova greda position reaches 35.6 %, which puts it at the lower level of the scale when compared to analogous examples from Europe and can be considered an ore of poorer quality in terms of technological usability, both in modern iron production and for technological solutions present in archaeological periods. The latter conclusion cannot be considered the exclusive rule for ores from the Podravina region, as evidenced by the wider range and variability of major oxides in fully formed ores and their development stages found in archaeological and/or geological context, in which the Fe_2O_3 content ranges from 37 to 49 mass. % and less frequently from 68 to 70 mass. % (Brenko et al. 2020; 2021).⁶ Significant variability of iron content in individual ores could be explained by the wide spatial distribution of compared samples and complex formation mechanisms that are strongly dependent on microenvironmental conditions in the soil, that is the immediate environment in which the ores form. The formation of bog iron ore deposits takes several hundred to thousands

6 Raspon se odnosi na razlike u sastavu ruda koje nisu podvrgnute postupku prženja, a koji je prema mineraloškoj analizi nalaza rude iz arheoloških cjelina bio korišten kao priprema za taljenje tijekom promatranh arheoloških razdoblja (kasna antika i rani srednji vijek). Postupkom prženja udio željezovih oksida u pravilu se povećava te se ne može smatrati komparativnim materijalom. Ipak, kod uzoraka prženih željeznih ruda lokalnog podrijetla pronađenih u arheološkome kontekstu zabilježene su znatno više i niže vrijednosti od spomenutih, uključujući uzorak s položaja Kalinovac – Hrastova greda (za rezultate kemijske analize: Brenko et al. 2021: Tab. 4).

6 The range refers to differences in the composition of ores that have not been subjected to roasting, which was used as preparation for the smelting during observed archaeological periods (Late Antiquity and Early Middle Ages), according to the mineralogical analysis of the finds from archaeological sites. As a rule, the proportion of iron oxides increases with roasting and cannot be considered comparative material. However, analysed samples of roasted iron ores of local origin found in the archaeological context, show significantly higher and lower values, including the sample from the Kalinovac – Hrastova greda (for chemical analyses: Brenko et al. 2021: Tab. 4).

rude traje nekoliko stotina do tisuća godina (Banning 2008), što ih svrstava u brzoformirajuća ležišta. Prema nekim studijama močvarne željezne rude su obnovljiv resurs te je proces obnavljanja ležišta moguć tijekom 8 – 10 i/ili 25 godina (Ramanaidou, Wells 2014: 343), dok kod drugih ležišta takva regeneracija nije uočena (Thelemann et al. 2017: 479). Stoga se postavlja pitanje predstavlja li ležište pronađeno na položaju Kalinovac – Hrastova greda neoformaciju i u kojoj mjeri je ruda prošla kroz razvojni proces te postoje li optimalni preduvjeti za neometan razvoj. Formativni proces močvarnih željeznih ruda u osnovi ima tri razvojna stadija koji sežu od meke nestabilne forme do čvrstih konkretnih slojeva. Činjenica da su sve tri razvojne faze močvarne željezne rude utvrđene u neposrednoj blizini na položaju Kalinovac – Hrastova greda govori u prilog da je proces formacije rude moguć i aktivan u suvremenoj krajoliku. Međutim, da bi se močvarna željezna ruda u potpunosti razvila, niz prethodno spomenutih preduvjeta mora biti zadovoljen, a uvjeti u tlu stabilni. Osim fizičke evolucije u formi (meka nestabilna – tvrda stabilna), proces razvoja rude obilježava i izmjena odnosa udjela glavnih oksida vidljiva na geokemijskoj razini. Razvojem rude u pravilu je moguće očekivati primjetne razlike u udjelima dvaju glavnih oksida, željezovoga i silicijevoga. Tako će se kroz proces razvoja očitovati povećanje Fe_2O_3 , dok će se udio SiO_2 snižavati (Brenko et al. 2021: 18, sl. 3; Thelemann et al. 2017: 478). Razlike u geokemijskom sastavu različitih faza formacije močvarne željezne rude mogu se pratiti na dijagramu regresije. Dva uzorka tla (tab. 3) imaju najviše udjele SiO_2 te najniže udjele Fe_2O_3 . To se može dovesti u vezu s načinom formiranja močvarne željezne rude, gdje prva faza predstavlja tlo obogaćeno Fe matriksom te na taj način i sadrži djelomično povišen udio Fe (Brenko et al. 2021). Močvarne željezne konkrecije nastaju tijekom naprednijega stadija cementacije Fe matriksom. Stoga se po fizikalnim svojstvima, poput tvrdoće, konkrecije i ističu od močvarno željeznoga tla (tab. 2). Fragmenti, kao završna faza formiranja, nastaju aglomeracijom većega broja konkrecija ili vrlo intenzivnom Fe cementacijom gdje dolazi do potiskivanja alumosilikatnog matriksa s Fe matriksom (Brenko et al. 2021). Stoga bi fragmenti trebali imati najveći udio Fe_2O_3 te najniži udio SiO_2 . Prema rezultatima usporedbe odnosa Fe_2O_3 i SiO_2 (sl. 6) izme-

of years (Banning 2008), which classifies them as rapidly forming deposits. According to some studies, bog iron ores are a renewable resource, and the process of deposit restoration is possible within 8–10 and/or 25 years (Ramanaidou, Wells 2014: 343), while for some deposits such regeneration has not been observed (Thelemann et al. 2017: 479). Therefore, the question arises as to whether the deposit found at the Kalinovac – Hrastova greda is a neoformation, to what extent has the ore passed through the development process and whether there are optimal preconditions for unhindered development. The formative process of bog iron ores has three development stages, ranging from a soft unstable form to hard concrete layers. The fact that all three formative stages have been found in the immediate vicinity at the Kalinovac – Hrastova greda area speaks in favour that the process of ore formation is possible and active in today's landscape. However, for bog iron ore to fully develop, a number of the aforementioned prerequisites must be met and conditions in the soil must be stable. In addition to physical evolution in form (soft unstable – hard stable), the process of ore development is visible on the geochemical level and characterized by changes in the ratio of major oxides. With the development, as a rule, it is possible to expect noticeable differences in the proportions of the two main oxides, iron and silica. Thus, an increase in Fe_2O_3 will manifest through the development process, while the SiO_2 content will decrease (Brenko et al. 2021: 18, Fig. 3; Thelemann et al. 2017: 478). Differences in the geochemical composition of bog iron ore formation phases can be monitored through the regression diagram. The two soil samples (Tab. 3) have the highest SiO_2 content and the lowest Fe_2O_3 content. This can be related to how bog iron ore is formed, where the first phase is the soil enriched with a Fe matrix and thus contains a partially elevated Fe content (Brenko et al. 2021). Bog iron nodules are formed during the more advanced stage of Fe matrix cementation. Therefore, in terms of physical properties such as hardness, the nodules stand out from the bog iron soil (Tab. 2). Fragments as the final stage of development, are formed by agglomeration of a larger number of nodules or very intensive Fe cementation where the aluminosilicate matrix is suppressed with the Fe matrix (Brenko et al. 2021). Therefore, the fragments should have the highest content of Fe_2O_3 and the lowest content of SiO_2 . According to the results of the

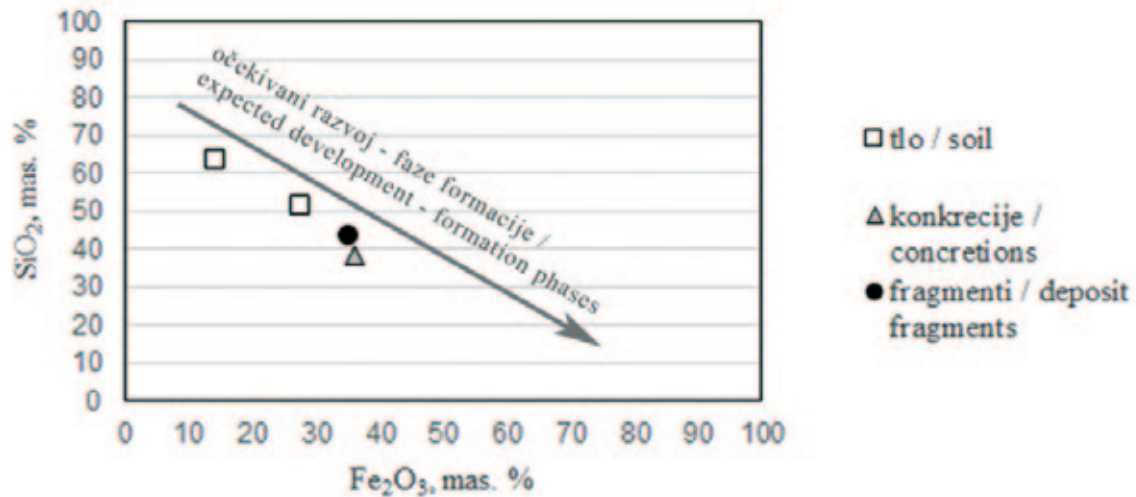

Sl. 6 — Dijagram regresije uzoraka močvarnoga željeznog tla, konkrecija i fragmenta rude s položaja Kalinovac – Hrastova greda 1 – 3 (izradili: T. Karavidović i T. Brenko, 2021.)

Fig. 6 — Regression diagram of bog iron soil, nodules and ore fragments samples from the position Kalinovac – Hrastova greda 1–3 (made by: T. Karavidović and T. Brenko, 2021)

đu pretpostavljenih razvojnih faza, analizirani fragmenti iz razorenoga depozita na položaju Kalinovac – Hrastova greda mogu se smatrati nepotpuno razvijenom rudom, odnosno početnim stadijom zadnje faze (neo)formacije.

Stanje u kojemu je otkriven depozit i činjenica da su ostale razvojne faze pronađene na površini tla svjedoči o inhibiciji razvoja i održanja ležišta. Uslijed dubokoga oranja, ležište je razoreno i djelomično dislocirano iz primarnoga položaja. Prema podacima prikupljenima pri sondiranju ležišta, sloj oranja dubok je 40/50 cm, što se u stručnoj terminologiji naziva dubokim oranjem (ili oranje s podrivanjem). Ovakav tip oranja, uz kombinaciju gnojiva, pogodno djeluje na uspješnost kultivacije i prinos kod određenih kultura na glejnim i pseudoglejnim tlima (Butorac et al. 2000) kakva su prisutna na prostoru donje Podravine, pa tako i položaju Kalinovac – Hrastova greda. Međutim, osim neposrednih mehaničkih oštećenja ležišta suvremenim metodama poljoprivredne obrade zemljišta, druge melioracijske mjere te čimbenici poput eksploatacije rude i klimatske promjene mogu onemogućiti formaciju močvarnih ruda ili degradirati postojeće depozite (Kaczorek, Sommer 2003: 400–401; Sitschick et al. 2005; Puttkammer 2012; Thelemann et al. 2017: 479). Na širem prostoru Podravine, time i položaju Kalinovac – Hrastova greda, upravo su spo-

comparison of the ratio of Fe_2O_3 and SiO_2 (Fig. 6) between the assumed development phases, the analysed fragments from the destroyed deposit at the Kalinovac – Hrastova greda position can be considered incompletely developed ore, i.e. the initial stage of the last phase of (neo)formation.

The condition in which the deposit was discovered and the fact that other developmental stages were found on the soil surface testifies to the inhibition of the development and preservation of the deposits. Due to deep ploughing, the deposit was destroyed and partially dislocated from the primary position. According to the data collected during the deposit excavation, the ploughing level is up to 40/50 cm deep, which is regarded as deep ploughing (or ploughing with undermining). This ploughing type combined with fertilizers has a favourable effect on cultivation success and yield in certain crops on gley and pseudogley soils (Butorac et al. 2000), present in the lower Podravina region and the Kalinovac – Hrastova greda position. However, in addition to direct mechanical damage to deposits by modern agricultural tillage methods, other land reclamation measures, ore exploitation and climate changes may prevent the formation of bog iron ores or degrade the existing deposits (Kaczorek, Sommer 2003: 400–401; Sitschick et al. 2005; Puttkammer 2012; Thelemann et al. 2017: 479). In the broader area of the Podravina region, and thus the position Ka-

menuti antropogeni utjecaji prisutni kroz povijesna, ali i arheološka razdoblja. Eksploatacija lokalne močvarne željezne rude posredno je dokumentirana nalazima rude na arheološkim lokalitetima u okolini sela Virje i Hlebine (Karavidović 2020; Brenko et al. 2021), a na položaju Kalinovac – Hrastova greda moguće ju je pretpostaviti obzirom na karakter istražena arheološkog lokaliteta. Podravina je danas uglavnom poljoprivredna regija, što je omogućeno kroz niz melioracijskih mjera primjenjenih u proteklim stoljećima. Poznati su rani primjeri krčenja šuma u svrhu stvaranja obradivih zemljišta iz 17. – 19. stoljeća (Feletar 1989: 279; Petrić 2012: 64–69), a intenzivni hidroregulacijski radovi započeli su u 19. stoljeću te se od tada dinamično primjenjuju (Slukan-Altić 2002: 130–132; Petrić 2013; Petrić et al. 2019: 110–119). Najznačajniji utjecaj na okoliš vjerojatno je iniciran izgradnjom hidroelektrana na gornjem toku rijeke Drave. Posljedica rada hidroelektrana je postupno smanjenje razine vode (površinske i podzemne), sužavanje vodene površine korita Drave kao i povećanje plavne doline, isušivanje pritoka, smanjenje učestalosti pojave i trajanja poplava te pojačana erozija (Kiss, Andrasí 2019: 163–166, 172–173).⁷ Za očekivati je da su kontinuirane i intenzivne promjene koje utječu na dinamiku i stabilnost uvjeta u tlu značajno utjecale i na razvoj te održivost ležišta močvarne željezne rude o čemu, osim stanja ležišta na položaju Kalinovac – Hrastova greda, može svjedočiti i malobrojnost te široka prostorna distribucija površinski prikupljenih uzoraka rude diljem Podravine (karta 1).

Prostor formiranja i fizionomija ležišta

Prisutnost različitih razvojnih faza, njihova široka prostorna distribucija te diskontinuitet pojave na istraženom položaju (karta 3: a) svjedoče da na nekoliko mikrolokacija trenutno postoje osnovni preduvjeti za razvojni proces močvarnih željeznih ruda i potencijalno više, prostorno odvojenih ležišta. U potpunosti formirani slojevi (treća razvojna faza) vjerojatno se stvaraju na pojedinačnim mikrolokacijama u formi leća čvrsto konsolidirane močvarne željezne rude ili isprekidanih slojeva različite debljine, ovisno o preduvjetima za akumulaciju željeza i

linovac – Hrastova greda, the mentioned human influences were present through historical and archaeological periods. The exploitation of local bog iron ore has been indirectly documented by ore finds on archaeological sites near the villages Virje and Hlebine (Karavidović 2020; Brenko et al. 2021), and at the Kalinovac – Hrastova greda position, it can be assumed given the character of the excavated archaeological site. Today, Podravina is mainly an agricultural region, which was made possible by numerous land reclamation measures applied in the past centuries. Early examples of deforestation to create arable land from the 17th to 19th century are known (Feletar 1989: 279; Petrić 2012: 64–69), and intensive hydro-regulatory works began in the 19th century and have been applied dynamically since then (Slukan-Altić 2002: 130–132; Petrić 2013; Petrić et al. 2019: 110–119). The most significant impact on the environment was initiated probably by the construction of hydroelectric power plants in the upper part of the Drava River. The consequence of their establishment is a gradual decrease in water levels (surface and groundwater), narrowing of the Drava channel and expansion of the floodplain, drying of tributaries, reduction of the frequency and duration of floods and increase of erosion (Kiss, Andrasí 2019: 163–166, 172–173).⁷ It is to be expected that continuous and intensive changes affecting the dynamics and stability of soil conditions have a significant impact on the development and sustainability of bog iron ore deposits, which, apart from the Kalinovac deposit condition, can be evidenced by the small number and wide spatial distribution of ore samples collected on the soil surface throughout the Podravina region (Map 1).

Formation area and physiognomy of deposits

The presence of different development phases, their wide spatial distribution and discontinuous occurrence at the investigated position (Map 3: a) testifies that, at several micro-locations, elementary preconditions for the development process of bog iron ore are present and that potentially, there are several spatially separated deposits. Fully developed layers of consolidated bog iron ore (third development phase) are likely to form

⁷ Ovi zaključci temelje se na istraživanju užega područja između mjesta Botovo i Gola, oko 13 km dugome prostoru rijeke Drave i njezine plavne nizine.

⁷ These conclusions are based on the study of the narrower area between Botovo and Gola, about 13 km long area of the Drava River and its floodplain.

formaciju rude u tlu. Trenutno nema indikacija da se ruda razvija u vidu neprekinutih, masivnih slojeva kakav je slučaj kod nekih poznatih ležišta (Thelemann et al. 2017: 478 i pripadajuće reference). Prirodni preduvjeti nastanka ovakvoga tipa ležišta povezani su s tokovima podzemnih voda, njihovom oscilacijom te geomorfologijom ove prostorne mikrocjeline. Oscilacija razine podzemne vode kroz hidrološku godinu i njena visina bitan su faktor pri nastanku močvarnih željeznih ruda, a idealne preduvjete za akumulaciju željezne rude u tlu čini kontaktna zona na kojoj se razina podzemne vode mijenja, odnosno močvarno tj. nizinsko vlažno područje koje periodično poplavljuje (Werońska 2009: 24). Prosječna dubina razine podzemne vode na profilu tla Kalinovac – Hrastova greda je oko 100 cm, a najplića dubina do 10 cm ispod površine tijekom razdoblja visokih podzemnih voda (Brenko et al. 2020: Fig. 3) zahvaćajući time humusno-akumulativni horizont (sl. 2: b). Analiza profila tla ukazuje na prisutnost i najveću zasićenost s getitom u intervalu dubine od 60 do 80 cm te nešto nižu u slijedećem intervalu do 100 cm dubine (tab. 2–3: 1–2), dok je iz stratigrafije slojeva razorenoga ležišta moguće zaključiti kako su čvrsti slojevi močvarne rude bili formirani na dubini oko 30 – 50/70 cm, a u dubljim slojevima makroskopski su prepoznati sporadični tragovi željezovitih nakupina (do maksimalno 100 cm dubine). Oba podatka potvrđuju da se zona formiranja nalazi na dubini 30 – 70 cm, do maksimalno 80/100 cm dubine unutar koje i podzemne vode najizraženije osciliraju tijekom hidrološke godine (sl. 2: b). Ovakvi podaci poklapaju se s općim podacima u vezi sa zonom formiranja močvarne željezne rude (Stoops 1983; Kaczorek, Sommer 2003) te dubinom oksidacijskih (50 – 60 cm dubine) i reduktivnih uvjeta u tlu (zona ispod oksidacijske), ali i dubinom podzemne vode u odnosu na nadmorsku visinu terena u širem okruženju položaja Kalinovac – Hrastova greda (112 – 111 m n.v. prema: Brkić, Briški 2018: Supl. 1). Ležišta močvarne željezne rude na području srednje i sjeverne Europe nalaze se na dubini od 20 do 60 cm (Thelemann et al. 2017: 480), što u načelu odgovara podacima dobivenima na položaju Kalinovac – Hrastova greda. Uzevši u obzir podatke dobivene sondiranjem razorenoga ležišta, moguće je zaključiti i da su postojeća ležišta relativno tanki (15 – 20 cm), vjerojatno isprekidani slojevi lećaste forme.

at individual micro-locations as lens-shaped or intermittent layers of varying thickness, depending on the preconditions for iron accumulation and ore formation in the soil. There is no indication of continuous, uninterrupted layers, as is the case, with some known deposits (Thelemann et al. 2017: 478 and references therein). Natural preconditions for the formation of this type of deposit are related to groundwater flow and oscillation as well as the geomorphology of this spatial micro-unit. The groundwater level oscillation during the hydrological year and its height are relevant for the formation of bog iron ores, and the ideal precondition for the accumulation of iron ore in the soil is the contact zone where the groundwater level changes, that is, a lowland area that periodically floods (Werońska 2009: 24). The average depth of groundwater level as seen on the soil profile Kalinovac – Hrastova greda is about 100 cm, and the shallowest depth up to 10 cm below the surface during the period of high groundwater (Brenko et al. 2020: Fig. 3), reaching the humus-accumulative horizon (Fig. 2: b). Analysis of the soil profile indicates the presence and highest saturation with goethite in the depth interval from 60 to 80 cm and slightly lower up to 100 cm depth (Tab. 2–3: 1–2), while through the stratigraphy of the destroyed bog iron deposit, it is possible to conclude that solid layers of bog ore were at a depth of about 30–50/70 cm, and in deeper layers, sporadically traces of iron accumulations (up to a maximum depth of 100 cm) were macroscopically recognized. Both data confirm that the formation zone is at a depth of 30–70 cm, up to a maximum of 80/100 cm depth, within which groundwater mostly oscillates during the hydrological year (Fig. 2: b). Such data coincide with general data regarding the zone of formation of bog iron ore (Stoops 1983; Kaczorek, Sommer 2003) and the depth of oxidating (50–60 cm depth) and reducing conditions in the soil (zone below oxidation), but also the depth of groundwater in relation to the terrain altitude in the broader area of the Kalinovac – Hrastova greda position (112–111 m a.s.l. according to Brkić, Briški 2018: Supl. 1). Bog iron ore deposits in Central and Northern Europe are at a depth of 20 to 60 cm (Theleman et al. 2017: 480), which in principle corresponds to the data obtained at the position Kalinovac – Hrastova greda. Taking into account the data obtained by probing the area of the destroyed deposit, it is possible to conclude that the existing deposits are relatively thin (15–20 cm),

O položaju potencijalnih ležišta svjedoči prostorna distribucija indikativnih geoloških tvorevina uočenih pri terenskome pregledu i sondiranju u odnosu na reljefne značajke (karta 3: a, c–d). Koncentracije tla zasićenoga željezovim oksidima (crvena, rahla zemlja), konkrecija i fragmenata rude vidljivih na površini kao posljedica oranja dubljih slojeva te položaj istraženog ležišta nalaze se na najnižim dijelovima terena, plićim i prostorno ograničenim pojedinačnim potolinama smještenim podno blagih uzvišenja, gdje je mogućnost plavljenja i zadržavanja vode najviša. Na ovim prostorima primjećena je stajaća voda i veća vlažnost površinskoga tla, dok se blage uzvisine mogu okarakterizirati kao ocjedite, s pjeskovitim tlom. Prediktivno modeliranje topografskoga indeksa vlažnosti (karta 3: c) u velikoj mjeri odgovara situaciji zatečenoj pri terenskome pregledu, iako algoritam ove analize u osnovi označava potencijal vlažnosti tla uzrokovan slijevanjem i zadržavanjem oborinskih voda, a vlažnost tla na položaju Kalinovac – Hrastova greda može biti uzrokovana i visinom podzemnih voda naspram relativne dubine potolina, odnosno nadmorske visine s obzirom da u razdoblju visokih voda dosežu humusno – akumulativni sloj. Pedološki, tlo je na cijelome promatranom prostoru položaja Kalinovac – Hrastova greda klasificirano kao močvarno glejno (Envi 2021) i kao takvo je pogodno za nastanak močvarnih ruda (Kaczorek, Zagórski 2007). Međutim, prostori na kojima se zadržava voda rezervirani su za plitke potoline na ovoj mikrolokaciji. Također, na gredama blago izdignutima iz krajolika tlo je pjeskovito i ocjedito te podzemne vode ne dosežu površinske slojeve, stoga ovi položaji ne predstavljaju idealne okolišne uvjete za razvoj močvarnih željeznih ruda. Dodatnu potvrdu nepotpunih uvjeta za formaciju željezne rude na prostoru blagih uzvišenja čine i pedotvorevine pronađene na padinama (sl. 3: b; tab. 2: 5; karta 3: a). Obzirom na sastav i nešto viši položaj pronalaska uz rubove blagih uzvišenja, mogućnost taloženja je vrlo vjerojatno smanjena zbog niske razine utjecaja podzemnih voda te vrste okruženja, tla. Prostorna distribucija indikativnih geoloških tvorevina pronađenih na površini tla pokazuje određene pravilnosti te može svjedočiti i o potencijalu prostora za razvoj rudnih ležišta (sl. 3: a–b). Najviši potencijal, pretpostavljen obzirom na prisutnost uznapredovale faze razvoja (fragmenti), imaju dijelovi plitkih

probably intermittent layers of lenticular shape.

The position of potential deposits is evidenced by the spatial distribution of indicative geological formations, observed during the field survey and probing, in relation to the relief features (Map 3: a, c–d). Concentrations of soil saturated with iron oxides (red, loose soil), nodules and fragments of ore, visible on the surface as a result of ploughing deeper layers, and the position of the explored deposit, are found in the lowest parts of the terrain, shallow and spatially limited individual depressions where flooding and water retention is highest. Some retained water and higher surface soil moisture were observed in these areas, while mild elevations are drained, with sandy soil. Predictive modelling of the topographic wetness index (Map 3: c) largely corresponds to the situation found during the field inspection, although the algorithm of this analysis basically indicates the soil moisture potential caused by runoff and retention of rainwater and soil moisture at Kalinovac – Hrastova greda can be caused by the height of groundwater compared to the relative depth of the depressions and altitude, given that in the period of high water they reach the humus – accumulative layer. Pedologically, the soil in the entire observed area of the Kalinovac – Hrastova greda position is classified as gleysol (Envi 2021), which is suitable for the formation of bog iron ores (Kaczorek, Zagórski 2007). However, areas where water is retained, are reserved for shallow depressions at this micro-location. Also, on ridges slightly elevated from the surrounding landscape, the soil is sandy and drained, and the groundwater does not reach surface layers, so these positions do not represent ideal environmental conditions for bog iron ore development. Additional confirmation of incomplete conditions for the formation of iron ore on the mild elevations are the pedological features found on the slopes (Fig. 3: b; Tab. 2: 5; Map 3: a). Given the composition and slightly higher position along the edges of mild elevations, the precipitation is probably reduced due to the low level of impact of groundwater and the type of surrounding environment, the soil. The spatial distribution of indicative geological formations found on the soil surface shows certain regularities and can testify to the potential of an area for the development of ore deposits (Fig. 3: a–b). The highest potential, assumed through the existence of an advanced stage of development (fragments), is in the parts of shallow depressions situated at an altitude slightly higher or equal to the

depresija čiji se vrh nalazi na nadmorskoj visini nešto višoj ili istovjetnoj s gornjom granicom zone fluktuacije podzemnih voda, vidljivo na uzorku profila tla (sl. 2: b; karta 3: a–b). Potonje se može dovesti u vezu s preduvjetima za taloženje željeza i procesom razvoja močvarne rude. Pretpostavljena kontinuirana prisutnost podzemne vode u dubljim dijelovima depresija dovodi do pojave reduktivnih uvjeta u tlu, pri čemu je Fe^{2+} mobilno te nisu ostvareni idealni preduvjeti za značajnije taloženje željeza.

Lećasti ili gnjezdoliki tip ležišta, prema primjeru široko rasprostranjenih ležišta u Europi, uobičajeno se pojavljuje na vlažnim nizinjskim prostorima (Zwahr et al. 2000: 83, sl. 7; Banning 2008; Werońska 2009: 27), dok se neprekinuti horizonti rudnih naslaga javljaju najčešće na pjeskovitim rubovima vlažnih depresija (Zwahr et al. 2000: 83, sl. 7; Thelemann et al. 2017: 476; Kaczorek, Sommer 2003). Na položaju Kalinovac – Hrastova greda moguće je izdvojiti više pojedinačnih depresija zatvorenoga tipa, različitih dimenzija, odnosno volumena, ali prilično ujednačene nadmorske visine i odnosa naspram uzvišenja (karta 3: d). S obzirom da su na ovim prostorima ostvareni svi teoretski preduvjeti razvoja, a površinski su prisutni i indikativni elementi, moguće je zaključiti da bi potencijalne leće močvarne rude mogle biti različitoga obima, a pojavljivale bi se isprekidano unutar određene reljefne mikrocjeline. Razlike u dubini i obliku depresija mogle bi upućivati na razlike u fizionomiji ležišta, prvenstveno obliku i debljini sloja rude. Širi prostor Podravine, poglavito longitudinalna zona (sjeverozapad – jugoistok) druge Dravske terase, geomorfološki je vrlo sličan promatranome položaju Kalinovac – Hrastova greda, a u krajoliku dominiraju niska uzvišenja među potolinama i starim rukavcima rijeke Drave te se dinamično izmjenjuju zamočvarena i ocjedita područja. Iz tog razloga moguće je očekivati slične mehanizme formiranja rude, izgled i položaje ležišta diljem regije, iako nije isključeno postojanje drugih tipova ležišta močvarne rude poput neprekinutih horizonata.

Tehnološka iskoristivost rude: kvaliteta rude i uspješnost postupaka taljenja

Rezultati eksperimentalnoga testiranja tehnološke iskoristivosti rude primjenom direktne redukcije ukazuju da rudu iz ležišta Kalinovac

upper limit of the groundwater fluctuation zone, seen in the soil profile sample (Fig. 2: b; Map 3: a–b). The latter can be related to the preconditions for iron precipitation and the process of bog iron ore development. The assumed continuous presence of groundwater in the deeper parts of the depressions leads to formation of reductive conditions in the soil, where Fe^{2+} is mobile, so the ideal preconditions for significant iron precipitation are not present.

Lenticular or nest-type deposits, following the example of widespread deposits in Europe, commonly occur in wetter lowland areas (Zwahr et al. 2000: 83, Fig. 7; Banning 2008; Werońska 2009: 27), while continuous horizons of ore deposits most often occur on sandy edges of moist lowlands (Zwahr et al. 2000: 83, Fig. 7; Thelemann et al. 2017: 476; Kaczorek, Sommer 2003). On the Kalinovac – Hrastova greda position, it is possible to single out individual closed depressions of different dimensions and volume but of relatively uniform altitude and relationship to surrounding elevations (Map 3: d). Given that all theoretical preconditions for development are present in this area and indicative elements are also present, it is possible to conclude that potential bog iron ore lenses could be of different sizes and would appear intermittently within a certain relief micro-unit. Variable shape and depth of depressions could indicate differences in the physiognomy of the deposits, primarily the shape and thickness of the ore layer. The Podravina area, especially the longitudinal zone (northwest – southeast) of the second Drava River terrace, is geomorphologically very similar to the observed Kalinovac – Hrastova greda position, as low elevations among the valleys and old tributaries of the Drava River and dynamically alternating swampy and drained areas dominate the landscape. For this reason, similar mechanisms of ore formation, appearance and deposit positions are to be expected throughout the region, although other types of bog iron deposits, such as continuous layers may also be present.

Technological usability of the ore: ore quality and success of smelting processes

The results of experimental testing of technological usability of ore by direct reduction indicate that the ore from the Kalinovac – Hrastova

– Hrastova greda nije moguće uspješno istaliti, odnosno dobiti spužvasto željezo. Teoretski, razlog neuspješnosti postupka može se ogleđati u karakteristikama sirovina, strukturnim (dizajn peći) te operativnim parametrima postupka (način izvođenja postupka te razina i vrsta pripreme sirovina). Međutim, dizajn peći i operativni parametri bili su isti kao i kod prethodno izvedenih eksperimenata u kojima je također korištena močvarna željezna ruda, a koji su rezultirali uspješnim ispuštanjem zgure tijekom postupka te formiranjem spužvastoga željeza (Karavidović 2020). Time je načelno isključena mogućnost značajnijega utjecaja ovih parametara na ishod taljenja, odnosno temeljni utjecaj moguće je pripisati sirovini, rudi. Komparativna analiza mineraloškoga i kemijskoga sastava rude kao i zgure može ukazati na tijek, razinu utjecaja parametara i razlog neuspješnosti postupka taljenja. Kemijski i mineraloški sastav zgure nastale taljenjem rezultat je kompleksne dinamike utjecaja sastava izvorišnih sirovina korištenih u postupku (ruda, ugljen, tehnička keramika – stijenke peći) te učinka termodinamičkih uvjeta u peći (temperatura, atmosfera) ostvarenih kroz operativne parametare upotrijebljene tijekom postupka (Seernels, Crew 1997; Crew 2000; 2007; Joosten 2004; Senn et al. 2010). Mineraloška analiza ukazala je da je u oba uzorka najzastupljeniji fajalit, očekivana mineralna faza kod zgure nastale proizvodnjom spužvastoga željeza. Fajalit nastaje reakcijom silikatne komponente (kvarca) i željezovitih minerala prisutnih u rudama pri temperaturi od 1100 do 1200 °C (Joosten et al. 1998: 130; Pleiner 2000: 135). Prisutnost alotropskih modifikacija silicijevo-ga dioksida, kvarca i kristobalita kod uzorka iz eksperimenta u peći 1 (tab. 4: 6) također je očekivana u zguri, no kada se pojavljuju u značajnoj mjeri označava i izrazitu količinu jalovine u rudi. Kristobalit je visoko temperaturna modifikacija kvarca te sugerira da je u peći postignuta temperatura iznad 1470 °C, a javlja se u zguri najčešće kada je zastupljenost silikatnih minerala u rudi značajna (Bachman 2016: 14). Temperaturni režim zabilježen kroz sapnicu ne ukazuje na tako visoke postignute temperature (sl. 4). Maksimalna temperatura unutrašnjosti peći, zabilježena kroz sapnicu, iznosi 1322 °C te se pojava kristobalita i postizanje ovako visokih temperatura tuma-

greda deposit cannot be successfully smelted, that is iron bloom iron cannot be obtained. Theoretically, the failure of the process can be caused by the characteristics of raw materials, structural (furnace design) and operational parameters applied (method of performing the procedure and the level and type of preparation of raw materials). However, the furnace design and the operating parameters were the same as in previously conducted experiments with bog iron ore, which resulted in the successful discharge of slag from the furnace during the process and the formation of an iron bloom (Karavidović 2020). In principle, this excludes the possibility of a significant impact of these parameters on the outcome of smelting, and the fundamental influence can be attributed to the raw material, the ore. Comparative analysis of the mineral and chemical composition of ore and slag can indicate the course, level of influence of parameters and the reason behind the failure of the smelting process. The chemical and mineralogical composition of slag formed by smelting is the result of complex dynamics of the influence of source raw materials used in the process (ore, charcoal, technical ceramics – furnace walls) and the effect of thermodynamic conditions in the furnace (temperature, atmosphere) gained by application of operational parameters (Seernels, Crew 1997; Crew 2000; 2007; Joosten 2004; Senn et al. 2010). Mineralogical analysis indicated that in both slag samples fayalite is most common, the expected mineral phase formed by the production of bloomery iron. Fayalite forms by the reaction of the silica component (quartz) and ferrous minerals present in ores, at 1100 to 1200°C (Joosten et al. 1998: 130; Pleiner 2000: 135). The presence of allotropic modifications of silicon dioxide, quartz and cristobalite, in the sample from the experiment in furnace 1 (Tab. 4: 6), is also expected in slag, but when they occur extensively, indicates a significant amount of silica in the ore. Cristobalite is a high-temperature modification of quartz and suggests that the temperature in the furnace is above 1470°C and occurs in slag when the presence of silicate minerals in the ore is significant (Bachman 2016: 14). The temperature regime recorded through the tuyere does not indicate such high temperatures (Fig. 4). The maximum temperature inside the furnace, recorded through the tuyere is 1322°C, so the appearance of cristobalite and the achievement of such high temperatures are interpreted as short-term temperature rise that

či kratkotrajnim temperaturnim izbojima koji nisu zabilježeni (mjerjenje je izvršeno u vremenskim razmacima od pola sata). Tome u prilog ide i niska zastupljenost kristobalita u uzorku te istovremena pojava kvarca. Moguće je da su se više temperature postigle nakon sesije odčepeljivanja sapnice kada je zbog kratkotrajnoga prestanka upuhivanja pretpostavljeno da se u peći smanjila temperatura te se pristupilo bržem ritmu upuhivanja zraka putem mijeha, odnosno intenzivnijem dotoku zraka u sustav – kratkotrajnom intenzivnom povećanju temperature. Uzorak zgure iz peći 2. (tab. 4: 7) u sastavu ima hematit i magnetit što se može tumačiti nepotpunom redukcijom rude te povišenom koncentracijom kisika u sustavu tijekom taljenja (Morton, Windgroove 1969; Manasse, Mellini 2002; Bachman 2016: 15–16; Thiele, Török 2011). Vrijedi napomenuti da se ovi minerali mogu javiti i kao sekundarna pojava uslijed oksidacijskih uvjeta pri solidifikaciji. U slučaju izvedenoga eksperimenta, prisutnost ovih mineralnih faza označava nepotpunu redukciju zbog prekida postupka, a u vezi je i s mjestom uzorkovanja (iznad sapnice – nije doseglo zonu najviših temperatura). Pojava silikatnih minerala feldspata/plagioklasa u neizmjenjenom obliku također može biti indikativna za nepotpunu redukciju s obzirom da su ovi minerali prisutni i kod ruda te tla.

Učinkoviti postupci direktne redukcije rude, teoretski bi trebali rezultirati redukcijom od 10 do 20 % mase Fe u proizvedeno spužvasto željezo (Sperling 2003; Puttkammer 2012). Iz rezultata kemijske analize vidljivo je da sadržaj željeza u zguri (tab. 5) kod oba eksperimenta nije niži no kod rude (tab. 3: 4), odnosno nije došlo do odvajanja željeza u spužvasto željezo.⁸ Močvarne željezne rude lako su taljive zbog svoje porozne strukture, ali i sastava, u prvome redu prisutnosti spojeva koji potpomažu proces direktne redukcije, taljenja (Pleiner 2000: 88). U kemijskome sastavu analiziranih uzoraka posebno je značajna iznimna količina SiO₂, vidljiva i na mineraloškoj razini u zastupljenosti minerala kvarca. Pojedini spojevi jalovine u rudi utječu na mogućnost stvaranja spužvastoga željeza i odvajanja zgure. Primjerice, SiO₂ ima izni-

was not recorded (measurement was performed at half-hour intervals). This is supported by the low presence of cristobalite in the sample and the simultaneous appearance of quartz. Higher temperatures were probably reached after the tuyere unclogging session when due to the short-term termination of blowing, it was assumed that the temperature in the furnace decreased, so a faster rhythm of blowing air through the tuyere was applied, which caused more intensive airflow into the system – a short term, intense temperature increase. The slag sample from furnace 2 (Tab. 4: 7) contains hematite and magnetite, which can be explained by incomplete reduction of ore and increased oxygen concentration in the system during smelting (Morton, Windgroove 1969; Manasse, Mellini 2002; Bachman 2016: 15–16; Thiele, Török 2011). It is worth noting that these minerals can also occur as a secondary phenomenon due to oxidative conditions during solidification. In the case of the experiment, the presence of these mineral phases is a result of the incomplete reduction, due to the process termination and is related to the sampling position (above the tuyere – did not reach the zone of highest temperatures). The appearance of silicate minerals feldspar/plagioclase in unaltered form may also be indicative of incomplete reduction since these minerals are present in ores and soil.

Efficient direct ore reduction processes should theoretically result in the reduction of 10 to 20 mass. % Fe into the produced iron bloom (Sperling 2003; Puttkammer 2012). The results of the chemical analysis of slag from both experiments show that the iron content (Tab. 5) is not lower than in the ore (Tab. 3: 4), i.e., there was no separation of Fe into the iron bloom.⁸ Bog iron ores are easily reduced due to their porous structure as well as composition, primarily the presence of compounds that support the process of direct reduction, smelting (Pleiner 2000: 88). The amount of SiO₂, visible at the mineralogical level in the presence of quartz minerals, is particularly significant in the chemical composition of analysed samples. Certain gangue compounds in the ore affect the possibility of the formation of iron bloom and the separation of slag. For example, SiO₂ has an exceptional, dual role (Tylecote et al. 1971: 360; Pleiner 2000: 136; Charlton et al. 2010: 353); it binds iron oxide and other oxides from the

8 Manje razlike u zastupljenosti mogu se pripisati ograničenoj mogućnosti preciznijega uzorkovanja zgure i rude, odnosno mogućoj varijabilnosti udjela glavnih oksida u izdvojenim uzorcima rude i zgure.

8 Minor differences in the representation can be attributed to the limited possibility of more precise sampling of slag and ore, ie the possible variability of the content of major oxides in the isolated samples of ore and slag.

nu, dvoznačnu ulogu (Tylecote et al. 1971: 360; Pleiner 2000: 136; Charlton et al. 2010: 353); on na sebe veže željezni oksid, ali i druge okside iz rude te ima značajnu ulogu u formaciji zgure. Ako je udio SiO_2 visok postoji mogućnost ranog formiranja fayalita (Fe_2SiO_4) uslijed čega formacija spužvastoga željeza može biti omeđena zbog nemogućnosti pristupa redukativnih agenata (CO). S druge strane, ako je udio SiO_2 nizak (2 – 3 %) redukcija željeznih oksida je otežana te dobar udio može završiti u masi zgure ili kao zasebne, nesinterirane čestice željeza. Uspješnost talioničkoga procesa općenito je iznimno ovisna o prisutnosti jalovina u sastavu rude, a u slučaju rude s Kalinovca – Hrastove grede pretežno o visokome udjelu silikata. Dodatna potvrda neuspjeloga postupka uvjetovanoga zastupljenošću SiO_2 vidljiva je iz indeksa redukcije željeza (RII). Ovaj indeks može odražavati učinkovitost redukcijskoga postupka kojim je nastala zgura te je vrijednost indeksa moguće pozitivno korelirati s uspješnošću postupka (Charlton et al. 2010). Kod oba uzorka zgure indeks redukcije željeza (tab. 5: 6–7) značajno prelazi vrijednost 1. Ako je indeks redukcije željeza veći od 1, SiO_2 ostaje u sustavu zgure te je moguće pretpostaviti višu razinu efikasnosti postupka taljenja, no prema primjeru izvedenoga eksperimenta visoke vrijednosti (2,734 i 2,463) označavaju rano stvaranje fayalita i izostanak izdvajanja spužvastoga željeza koji je moguće pripisati kvaliteti, odnosno sastavu rude, poglavito odnosu Fe_2O_3 i SiO_2 . Sastav rude i zgure te rezultati eksperimentalnoga taljenja svjedoče da je visok udio silikata u rudi inhibirao nastanak spužvastoga željeza u oba eksperimenta. Kod uzorka iz peći 2 ova situacija nije u potpunosti razvidna s obzirom na pojavu mineralnih faza koje upućuju na nepotpuni proces redukcije, što se može pripisati mjestu uzorkovanja. Međutim, uz snažnu zasićenost silikatima, kemijska slika uzorka iz peći 1 govori o pretjeranoj redukciji, a vidljivi su i utjecaji ostalih parametara iz sistema. Očituje se povećanje CaO, MgO, K_2O u odnosu na korištenu rudu koje se može pripisati primarno utjecaju sastava pepela od drvenoga ugljena, a u nekoj mjeri i stijenki peći (Crew 2000; 2007; Joosten 2004: 41–46, Fig. 14; Charlton et al. 2010: 354, Tab. 1). Kod uzorka iz druge peći ovo povećanje se ne očituje, odnosno utjecaji nisu ušli u sustav, što je moguće iznova pripisati nepotpunoj redukciji, odnosno prekinutome postupku.

ore and plays a significant role in the formation of slag. If the content of SiO_2 is high, there is a possibility of the early formation of fayalite (Fe_2SiO_4) due to which further access of reducing agents (CO) is not possible, and the formation of iron bloom is hindered. On the other hand, if the SiO_2 content is low (2–3%), the reduction of iron oxides is limited, and a good proportion can end up in the cinder mass or as separate, unsintered iron particles. The success of the smelting process is generally highly dependent on the presence of gangue in the ore, and in the case of ore from Kalinovac – Hrastova greda, mainly of high silica content. Another confirmation of the cause for the process failure owed to the representation of SiO_2 is visible from the iron reduction index (RII). The RII may reflect the efficiency of the reduction process by which the slag is formed, and the value of the index can be positively correlated with the success of the process (Charlton et al. 2010). In both slag samples, the iron reduction index (Tab. 5: 6–7) significantly exceeds 1. If the iron reduction index is greater than 1, SiO_2 remains in the slag system, so it is possible to assume a higher level of efficiency of the smelting process, but the experiment shows that high values (2.734 and 2.463) indicate the early formation of fayalite and the absence of iron bloom, which can be attributed to the quality and composition of the ore, especially the ratio of Fe_2O_3 and SiO_2 . The composition of ore and slag and the result of experimental smelting testify that the high content of silica in the ore inhibited the formation of iron bloom in both experiments. In the case of the sample from furnace 2, this situation is not fully evident due to the occurrence of mineral phases that indicate an incomplete reduction, which can be attributed to the sampling position. However, in addition to the high saturation with silica, the chemical analysis of the sample from furnace 1 indicates excessive reduction as well as the influence of other parameters from the system. There is an increase in CaO, MgO, K_2O in relation to the used ore, which can be attributed primarily to the influence of the composition of charcoal ash, and to some extent, the furnace walls (Crew 2000; 2007; Joosten 2004: 41–46, Fig. 14; Charlton et al. 2010: 354, Tab. 1). In the case of the sample from the second furnace, the increase is not evident, i.e. the influences did not enter the system, which can again be attributed to the incomplete reduction caused by procedure termination.

Eksploatacija i uporaba ruda: studija slučaja kasnoantičkih i ranosrednjovjekovnih indikativnih lokaliteta

Metoda eksploatacije i položaji ležišta

Genetska, geokemijska veza između ruda pronađenih u kontekstu radionica za proizvodnju željeza na prostoru Podravine i geoloških uzoraka iz terenskoga pregleda neupitno je pokazala da su se za proizvodnju željeza tijekom kasne antike i ranoga srednjeg vijeka koristile rude lokalnog/regionalnoga podrijetla (Brenko et al. 2021). Prema primjeru pretpostavljenih prostora ležišta na položaju Kalinovac – Hrastova greda, slojevi rude su isprekidano rasprostranjeni unutar prirodnih depresija, stoga je metoda eksploatacije tijekom arheoloških razdoblja mogla podrazumijevati kopanje plićih jama (50 – 100 cm ili pliće), rovova ili kanala nepravilnoga oblika. Sudeći prema geomorfologiji ove mikrolokacije i varijabilnim dimenzijama depresija, pojedinačna ležišta mogla su biti različitoga obima, pri čemu bi dugoročna eksploatacija podrazumijevala iskope uzduž rudnoga tijela. Ovakav način eksploatacije neće se nužno odraziti u arheološkome površinskom ili subpovršinskom zapisu kao sustav tlocrtno organiziranih, pravilnih ili jednoličnih oblika, već je mogao u značajnoj mjeri biti pod utjecajem rastera raspoloživih ležišta, odnosno u slučaju pretpostavljenih mjesta na kojima se formira močvarna ruda, geomorfologije. Mogućnost regeneracije i/ili stvaranje novih ležišta u relativno kratkim vremenskim okvirima, ali i utjecaj intenzivnoga ljudskog djelovanja na okoliš može negirati ili izmijeniti tragove eksploatacije iz prošlosti, stoga ubikacija ležišta iskorištavanih u arheološkim razdobljima predstavlja značajan izazov. Međutim, primjena modela prostora pojave ležišta na Kalinovcu na širi kontekst krajolika Podravine u kojemu su prisutni arheološki lokaliteti s tragovima proizvodnje željeza pokazuje određene pravilnosti. Na osnovi geomorfoloških karakteristika prostora oko lokaliteta na položaju Kalinovac – Hrastova greda, ali i ostalih lokaliteta sličnoga karaktera na tlu Podravine, na položajima Virje (Volarski breg i Sušine) te Hlebine (Velike Hlebine), moguće je pretpostaviti da su izvorišta rude mogla biti u neposrednoj blizini radionica za proizvodnju željeza datiranih u kasnu antiku i rani srednji vijek. Istražene radionice za proizvodnju i obradu

Ore exploitation and use: a case study of late antique and early medieval indicative sites

Exploitation method and deposit positions

The genetic, geochemical connection between ores found in the workshop for iron production context in the Podravina and geological samples from the field survey unquestionably showed that ores of local/regional origin were used for iron production during Late Antiquity and Early Middle Ages (Brenko et al. 2021). According to the example of assumed deposit areas at the Kalinovac – Hrastova greda position, ore layers are intermittently distributed within natural depressions, so the method of exploitation during archaeological periods could include digging of shallow pits (50–100 cm or shallower), trenches or irregularly shaped canals. Because of the geomorphology of this micro-location and the variable dimensions of the depressions, individual deposits could be of different sizes, with long-term exploitation involving excavation along the ore body. This method of exploitation will not necessarily reflect in archaeological surface or subsurface record as an organised layout system, regular or uniform shapes as it could be significantly influenced by the grid of available deposits, or in the case of presumed places where bog iron ores form, geomorphology. The possibility of regeneration and/or development of new deposits in a relatively short time frame and the impact of intense human intervention in the landscape can modify or negate the traces of exploitation from the past, so locating deposits used in archaeological periods is a significant challenge. However, the application of the model of the area of deposit occurrence on Kalinovac to the broader context of the lowland landscape in which archaeological sites with traces of iron production are present shows certain regularities. Based on the geomorphological characteristics of the area around the archaeological site at Kalinovac – Hrastova greda but also other sites of a similar character in the Podravina region, at Virje (Volarski breg and Sušine sites) and Hlebine (Velike Hlebine site), it is possible to assume that ore deposits could have been located in the immediate vicinity of iron production workshops. The investigated workshops for iron production and processing in the Podravina region were regularly set away from the settlement and positioned along the edges of floodplains (Sekelj

željeza na prostoru Podravine redovito su bile izdvojene iz naselja i pozicionirane uz rubove plavnih područja (Sekelj Ivančan, Karavidović 2021: Map 3–4), odnosno na niska uzvišenja okružena plitkim depresijama, potencijalnim prostorima formacije rude. Prisutnost željeza u tlu na položajima nedaleko lokaliteta Volarski breg i Sušine te Hlebine – Velike Hlebine potvrđena je i ranijim istraživanjima (Sekelj Ivančan, Marković 2017; Brenko et al. 2020). Odabir položaja radionica i smještaj izvan naselja mogao je biti uvjetovan blizinom i lakom dostupnošću osnovnih sirovina, rude, ali i drva.

Karakter ležišta i tehnološka prilagodba

Analiza kemijskoga i mineraloškoga sastava rude iz arheoloških cjelina s prostora Podravine (Brenko et al. 2021: Tab. 2; 4), datiranih u kasnu antiku i rani srednji vijek, ukazala je kako se većina ruda može smatrati kvalitetnim i tehnološki iskoristivim, s visokim udjelom željeznih oksida i nižim udjelom jalovina i fosfora. No, rude lošije kvalitete ($\leq 50\%$ mas. Fe_2O_3), poput rude s položaja Kalinovac – Hrastova greda, pronađene su na lokalitetima Virje – Volarski breg i Sušine. Ovi uzorci potječu iz zatvorenih arheoloških cjelina: radionice za proizvodnju željeza iz kraja 4. / početka 5. stoljeća (Brenko et al. 2021: Tab. 4: V–S 5–6; Sekelj Ivančan, Karavidović 2021: 58–65, Fig. 14: SJ 314) te struktura pripisanim naseobinskom kontekstu iz 8. / početka 9. stoljeća (Brenko et al. 2021: Tab. 2; 4: V–VB 1–3, V–S 2, 4; Sekelj Ivančan 2021: 158–163, 167–171), što pokazuje da su rude niže kvalitete u nekoj mjeri bile eksploatirane u kasnoj antici i ranome srednjem vijeku. Eksploatacija močvarnih ruda niske kvalitete mogla je biti uzrokovana nizom čimbenika poput nemogućnosti prepoznavanja ležišta kvalitetne i/ili potpuno razvijene rude ili izostanka istih uslijed eksploatacije, no prirodno uvjetovan razlog svakako je karakter ležišta močvarnih ruda. Ležišta na istoj lokaciji mogu sadržavati rudu varijabilnoga sastava, na što ukazuje razlika u sastavu konkrecija i fragmenta izdvojenih iz rudne leće s položaja Kalinovac – Hrastova greda (sl. 6) te zastupljenost minerala getita odnosno željeznih oksida na različitim dubinama uzorkovanog tla (tab. 2–3: 1–2). Konkrecije kao razvojna faza rude u ovome slučaju imaju potencijal postati kvalitetnijom rudom od fragmentata iz otkrivenoga ležišta, ako se pretpostavi daljnji razvoj i obogaćenje Fe matriksom, s

Ivančan, Karavidović 2021: Map 3–4), on low elevations surrounded by shallow depressions, potential areas of ore formation. The presence of iron in the soil at positions near the Volarski breg, Sušine and Hlebine – Velike Hlebine sites has been confirmed by previous research (Sekelj Ivančan, Marković 2012; Brenko et al. 2020). The workshop location selection and positioning outside the settlements could be conditioned by the proximity and easy procurement of the basic raw materials, ore and wood.

Nature of deposits and technological adaptation

Analysis of the chemical and mineral composition of ore samples from archaeological sites in the Podravina region (Brenko et al. 2021: Tab. 2; 4) dated to Late Antiquity and the Early Middle Ages, indicated that most analysed ores from the archaeological context can be considered technologically usable and quality ores with a high content of iron oxides and a lower content of gangue and phosphorus. Ores of poorer quality ($\leq 50\%$ mass. Fe_2O_3), such as ore from the Kalinovac – Hrastova greda position, were found at the Virje – Volarski breg and Sušine sites. These samples come from closed archaeological contexts: a workshop for the production of iron dated to the end of the 4th and beginning of the 5th century (Brenko et al. 2021: Tab. 4: V–S 5–6; Sekelj Ivančan, Karavidović 2021: 58–65, Fig. 14: SU 314) and features attributed to settlement contexts dated to the 8th and beginning of 9th century (Brenko et al. 2021: Tab. 2; 4: V–VB 1–3, V–S 2, 4; Sekelj Ivančan 2021: 158–163, 167–171), which indicates that the low-quality ores were exploited to some extent in Late Antiquity and the Early Middle Ages. The exploitation of low-quality bog iron ores could have been driven by several factors, such as the inability to identify deposits of quality or fully developed ores, as well as their absence due to exploitation, but the naturally conditioned reason is certainly the nature of bog iron ore deposits. Individual deposits at the same area may contain ore of variable composition, which is indicated by the difference in the composition of nodules and fragments extracted from the formed ore lens at the Kalinovac – Hrastova greda position (Fig. 6) and the level of representation of goethite minerals or iron oxides at different depths of the sampled soil (Tab. 2–3: 1–2). Nodules as a development phase of the ore, in this case, have the potential to become better quality ore than fully formed fragments from the discovered deposit, if

obzirom da već u ovoj fazi imaju viši udio Fe_2O_3 i sukladno niži udio jalovine. Analiza uzoraka tla ukazuje na viši i niži potencijal razvoja močvarne željezne rude, odnosno obogaćenja Fe matriksom u odnosu na dubinu unutar potencijalnoga ležišta, što je moguće dovesti u vezu s zonom oscilacije podzemnih voda. Također, u potpunosti razvijeni uzorci podravske rude s položaja Novigrad Podravski – Milakov Berek (Brenko et al. 2021: Tab. 2: NP–MB 16–18), pronađeni disperzirani po površini tla uslijed oranja, pokazuju značajne razlike u zastupljenosti glavnih oksida, a s obzirom na prostornu disperziju, vrlo vjerojatno potječu iz istoga ležišta. Eksploatacija ruda različite kvalitete iz jednoga ili više ležišta posvjedočena je i arheološkim nalazima ruda s lokaliteta Virje – Sušine datiranoga u kasnu antiku (kraj 4. i početak 5. stoljeća). U istome kontekstu, u sloju otpada (Sonda 7, SJ 314) unutar radionice, pronađeni su uzorci ruda varijabilnoga sastava, odnosno omjera prisutnosti glavnih oksida, i to u slučaju željezovih oksida 19,65 %, 45,57 % te 70,89 % mas. Fe_2O_3 (Brenko et al. 2021: Tab. 2, 4: V–S 1, 5–6). Ipak, ostaje otvoreno pitanje jesu li sve rude pronađene u arheološkome kontekstu, pa i one loše kvalitete, doista bile upotrebljavane u proizvodnji spužvastoga željeza ili je moguće očekivati postupke diskriminacije ruda prema kvaliteti, odnosno postupke pripreme rude koji podrazumijevaju smanjenje udjela jalovine u rudnome konglomeratu. Eksperimentalna testiranja direktne redukcije ruda poznata iz literature (Crew 1991a; 1991b; Crew, Salter 1991; Seernells, Crew 1997; Crew, Charlton 2007; Crew et al. 2011; Thiele 2010) ukazala su da je moguće istaliti močvarne rude niže zastupljenosti željeznih oksida, do 49 mas. % Fe_2O_3 , ali i niže ako su korištene u kombinaciji s kvalitetnijim rudama (Crew et al. 2011). Moguće je pretpostaviti da će u potonjim slučajevima prinos u spužvastome željezu biti niži u odnosu na kvalitetnije rude, a upitna je i kvaliteta krajnjega proizvoda (ovisno o ostalom sastavu rude), dva čimbenika koja su mogla imati značajnu ulogu u arheološkim razdobljima. Postupci pripreme ruda i prilagodba operativnih parametara teoretski bi mogli utjecati na tehnološku iskoristivost ruda. Međutim, upitna je razina poboljšanja svojstava rude i/ili utjecaj moderiranja operativnih parametara na uspješnost postupka taljenja, poglavito kod ruda kod kojih je udio jalovine dominantna sastavnica, što je slučaj kod

we assume further development and enrichment of Fe matrix, since already in this phase they have a higher content of iron oxides and accordingly lower gangue content. The analysis of soil samples indicates a higher and lower potential for the development of bog iron ore, i.e. enrichment with Fe matrix, concerning the depth within the potential deposit, which is related to the groundwater oscillation zone. Also, fully developed samples of ore from the Novigrad Podravski – Milakov Berek position (Brenko et al. 2021: Tab. 2: NP–MB 16–18), found dispersed on the soil surface due to ploughing, show significant differences in the major oxide content, and given the spatial dispersion, they most likely originate from the same deposit. The exploitation of ores of different quality, from one or more deposits, is attested by archaeological finds of ores from the Virje – Sušine site dated to Late Antiquity (end of 4th – beginning of 5th centuries). Samples of ores that were found in the same context, waste deposition layer (Trench 7, SU 314) within the iron production workshop have variable composition and ratio of major oxides, that is in the case of iron oxides, 19.65%, 45.57% and 70.89 mass. % Fe_2O_3 (Brenko et al. 2021: Tab. 2; 4: V–S 1, 5–6). However, the question remains whether all ores found in the archaeological context, even those of poor quality, were indeed used in the production of iron bloom or is it possible to expect procedures of discrimination of ores according to quality or ore, that is preparation that involves reducing the gangue in the ore conglomerate. Experimental tests of direct ore reduction known from the literature (Crew 1991a; 1991b; Crew, Salter 1991; Seernells, Crew 1997; Crew, Charlton 2007; Crew et al. 2011; Thiele 2010) indicated that it is possible to smelt bog iron ores with a lower iron oxide content, up to 49 mass. % Fe_2O_3 and even lower, if used in combination with higher quality ores (Crew et al. 2011). It is possible to assume that in the latter cases the yield in iron bloom will be lower compared to higher quality ores and the quality of the final product is questionable (depending on the rest of the ore composition), two factors that may have played a significant role in archaeological periods. Ore dressing and adjustment of operational parameters could theoretically affect the technological usability of ores. However, the level of improvement of ore properties and/or the impact of adaptation of the operating parameters on the success of the smelting process is questionable, especially with ores where the gangue is the

nekim arheoloških uzoraka iz 4./5. te 8./9. stoljeća (Brenko et al. 2021: Tab. 4: V–S 2–5) kao i rude s položaja Kalinovac – Hrastova greda. Taljenje nekvalitetne rude, u svakome slučaju, nosi visok rizik od potpune neuspješnosti procesa ili niskoga prinosa, posljedično nepotrebna utroška resursa. Postupak diskriminacije nekvalitetnih ruda ili jalovine u rudnome konglomeratu u nekoj mjeri bi smanjio rizik, a mogao je biti dio pripreme ruda. Priprema je mogla podrazumijevati čišćenje od jalovine (prebiranje, mehaničko čišćenje rude od jalovina, ispiranje), sušenje, prženje ruda i usitnjavanje (Pleiner 2000: 106–107). Prema mineraloškoj analizi, rude pronađene u kontekstu radionice za proizvodnju željeza iz kraja 4. / početka 5. stoljeća na lokalitetu Virje – Sušine (Sonda 7) prošle su kroz postupak prženja (Brenko et al. 2021: Tab. 3: V–S, 5–6), što posredno otvara i mogućnost izvođenja drugih postupaka pripreme čiji arheološki tragovi neće biti jasno zabilježeni. Ovi uzorci pronađeni su u sloju zasićenom otpadom od talioničkih postupaka, vjerojatno odlagalištu otpada pri rubu radionice (Sekelj Ivančan, Karavidović 2021: 59–62, Fig. 14a: SJ 314), što također može sugerirati postupak diskriminacije i odbacivanja (Brenko et al. 2021). Činjenica da su ostale rude niske kvalitete pronađene u naseobinskom kontekstu 8./9. stoljeća na lokalitetima Virje – Sušine (pržena, Sonda 8) i Volarski breg (nepržena, Sonda 2b), a ne u direktnoj vezi s radionicom unutar koje se talilo (Volarski breg, Sonda 1), također otvara mogućnost da ovi uzorci, iako prikupljeni iz ležišta, nisu bili korišteni za proizvodnju željeza. Oba primjera mogu predstavljati ostatke diskriminiranih, jalovih dijelova rudnih konglomerata.

Primjena postupaka pripreme, poglavito diskriminacije, predstavlja tehnološki uvjetovanu prilagodbu koja je u prošlosti morala biti utemeljena na iskustvenom i/ili prenešenom, tradicijskom znanju. Ishod postupka taljenja ovisi o karakteristikama upotrebljenih sirovina (ruda, ugljen), ali i konstrukcijskim (dizajn peći) te operativnim parametrima (način na koji se izvodi postupak i priprema sirovina) te je u većoj ili manjoj mjeri osjetljiv na promjene ovih izvedbenih (pred)uvjeta (Karavidović 2021b: 235–240). Pretpostavimo li da su se unutar jedne zatvorene arheološke cjeline, radionice za proizvodnju željeza (Sekelj Ivančan, Karavidović 2021), sustavno primjenjivali isti operativni parametri pri postupku taljenja te da je dizajn peći bio isti,

dominant component, as is the case with some archaeological samples from 4th–5th and 8th–9th centuries (Brenko et al. 2021: Tab. 4: V–S 2–5) as well as for ore from the Kalinovac – Hrastova greda position. The smelting of low-quality ore, in any case, carries a high risk of complete process failure or low yield, resulting in unnecessary resource consumption. The process of discriminating against substandard ores or gangue in an ore conglomerate would reduce the risk to some degree and could have been part of ore preparation. Preparation could include gangue cleaning (screening, mechanical methods, rinsing), drying, roasting and crushing (Pleiner 2000: 106–107). Results of the mineralogical analysis of the ores found in the context of the iron production workshop from the end of 4th–beginning of 5th centuries at the Virje – Sušine site (Trench 7) show that the ores were roasted (Brenko et al. 2021: Tab. 3: V–S 5–6), which indirectly opens the possibility of performing other preparation procedures, whose archaeological traces will not be unambiguously recorded. These samples were found in a layer saturated with waste from the smelting processes, probably a waste deposit area at the edge of the workshop (Sekelj Ivančan, Karavidović 2021: 59–62, Fig. 14a: SU 314), which may also suggest a process of discrimination and rejection (Brenko et al. 2021). The fact that other low-quality ores were found in the settlement context dated to 8th–9th century at Virje – Sušine (roasted, Trench 8) and Volarski breg (unroasted, Trench 2b) sites, and not the workshop where ores were smelted (Volarski breg, Trench 1), also opens the possibility that these samples, although collected from deposits, were not used for iron production. Both examples may represent remains of discriminated, barren parts of ore conglomerates.

The application of preparation procedures, especially discrimination, is a technological adaptation that had to be founded on experiential and/or transferred, traditional knowledge in the past. The outcome of the smelting process depends on the characteristics of the raw materials used (ore, charcoal) as well as construction (furnace design) and operational parameters applied (the way that the process is carried out and raw materials prepared), and it is more or less sensitive to changes in these performative (pre)conditions (Karavidović 2021b: 235–240). Assuming that within a single archaeological context, an iron production workshop (Sekelj Ivančan, Karavidović 2021), the same operating parameters were systematically applied

neuspjeh bi se pripisao jedinoj preostaloj varijabli, rudi. Također, u prošlosti je direktni pokazatelj uzroka neuspješnosti postupka ili niskoga prinosa mogla biti zgura. Prema primjeru zgure proizašle iz postupka taljenja kalinovačke rude, izrazita prisutnost jalovine (u prvome redu silikata) očituje se u boji, strukturi i konzistenciji zgure. Zguru karakterizira svijetlije sivozelenkasta boja vanjske površine i presjeka, vidljive čestice kvarca u presjeku i porozna struktura (niska razina viskoznosti) (sl. 5; tab. 4: 6–7). Potonje je mogao biti vizualni indikator i u tijeku postupka taljenja, pri ispuštanju zgure, kada se razina viskoznosti zgure očituje primarno u brzini istjecanja. U istome kontekstu, diskriminacija ruda po kvaliteti u prošlosti morala bi se oslanjati na prepoznavanje morfoloških pokazatelja lošije kvalitete. Komparativna analiza fizičkih, mineraloških i kemijskih svojstva rude s položaja Kalinovac – Hrastova greda jasno pokazuje da je moguće vizualno prepoznati snažnu prisutnost jalovine u sastavu rude, time i nižu kvalitetu (tab. 2: 4). Tako su sitniji pijesak ili šljunak te glina u strukturi mogli upućivati na potrebu dodatne obrade nekim od postupaka pripreme ili diskriminaciju nepovoljnih dijelova rudnih konglomerata. Usporedbom karakteristika grumenja pjeskovitih konkrecija s Fe matriksom i rude iz ležišta moguće je uočiti razliku u strukturi, gdje rude koje su prošle kroz opisane razvojne stadije (kvalitetnije rude) imaju vidljive aglomeracije pojedinačnih globularnih konkrecija (sl. 3; tab. 2: 4–5).

ZAKLJUČAK

Eksploatacija močvarnih željeznih ruda na prostoru Podravine u prošlosti je imala značajnu ulogu, o čemu svjedoče brojni površinski nalazi tragova proizvodnje željeza te genetska, geokemijska veza između ruda iz arheološkoga i geološkoga konteksta. Naznake postojanja ležišta i potencijal za razvoj močvarne rude u Podravini geološki je utvrđen tek recentim, ciljanim istraživanjima. U potpunosti razvijene rude pronađene su na površini oranica, što implicira razorenost podpovršinskih ležišta. Kontinuirana poljoprivredna aktivnost prisutna na većini položaja na kojima su prepoznati tragovi orudnjenja neupitno progresivno razara, degradira te može izazvati i nestajanje ležišta čime je smanjena mogućnost proučavanja eksploatacije i uporabe ruda u prošlosti. Stoga

in the smelting process and that the furnace design was the same, the failure would be attributed to the only remaining variable, the ore. Also, in the past, a direct indicator of the cause of process failure or low yield could be slag. Based on the slag derived from the smelting of Kalinovac ore, the pronounced presence of gangue (primarily silicates) is manifested in the colour, structure and consistency of slag. The slag is characterized by a lighter grey-greenish colour of the outer surface and cross-section, visible quartz particles in the cross-section and a porous structure (low viscosity level) (Fig. 5; Tab. 4: 6–7). The latter could also be a visual indicator during the smelting process, upon slag discharge, when the level of slag viscosity is manifested primarily in the flow rate. In the same context, quality discrimination of ores in the past should have relied on the recognition of morphological indicators of poorer quality. Comparative analysis of physical, mineral and chemical properties of ore from the position Kalinovac – Hrastova Greda clearly shows that it is possible to visually identify a strong presence of gangue in the ore, and thus lower quality (Tab. 2: 4). The presence of finer sand or gravel and clay may have indicated the need for additional processing by some of the preparation procedures or discrimination of unfavourable parts of ore conglomerates. Comparing the characteristics of sandy concretions with the Fe matrix and ore from the deposit, it is possible to see a difference in structure, where ores that have passed through the described development stages (higher quality ores) have visible agglomerations of individual globular concretions (Fig. 3; Tab. 2: 4–5).

CONCLUSION

The exploitation of bog iron ores in the Podravina area has played a significant role in the past, as evidenced by numerous surface finds of traces of iron production and the genetic, geochemical link between ores from the archaeological and geological context.

Indications for the existence of deposits and the potential for the development of bog ore in Podravina have been geologically determined only by recent, targeted research. Fully developed ores were found on the surface of arable land, which implies the destruction of subsurface deposits. Continuous agricultural activity, present at most locations where traces of ore have been identified, unquestionably destroys and degrades

je na temelju sustavno prikupljenih podataka s položaja Kalinovac – Hrastova greda 1–3 koji je pokazao najveći potencijal postojanja, ali i razvoja močvarne željezne rude izveden model ležišta, s ciljem primjene na prediktivnu geoarheološku analizu širega prostora Podravine. Analiza i rekonstrukcija ležišta na položaju Kalinovac – Hrastova greda pokazala je da je formiranje ležišta u suvremenome krajoliku Podravine pod značajnim, negativnim utjecajem novostvorenih preduvjeta, prvenstveno snižavanja razine podzemnih voda, a razvoj je inhibiran intenzivnom agrarnom aktivnošću. Ipak, proces razvoja ruda je aktivan. Potencijal pojave ležišta je najveći u plitkim, prostorno ograničenim depresijama, na relativnoj dubini od 30/50 – 80/100 cm i nadmorskoj visini od oko 112 do 110 m, odnosno u zoni kolebanja razine podzemnih voda obogaćenih s Fe. Rude se razvijaju u zoni oksidacijskih uvjeta, u okruženju siltozne ilovače i ilovače, odnosno unutar močvarnoga glejnog tla. Slične, oksidativne uvjete pri razvoju (getit kao glavna mineralna faza), time i sličan mehanizam razvoja, moguće je pretpostaviti i za arheološke uzorke rude (Brenko et al. 2021) pronađene na lokalitetima u vezi s proizvodnjom željeza na prostoru Podravine (Velike Hlebine, Dedanovice, Virje – Sušine i Volarski breg). Ležišta su vjerojatno tlocrtno nepraviloga, u presjeku pretežno lećastoga (gnjezdolikoga) oblika koji je uglavnom diktiran reljefnim značajkama i fizionomijom plitkih depresija u kojima se razvijaju. S obzirom na slične prirodne preduvjete širega prostora Podravine, poglavito druge dravske terase, postojanje ovakvoga tipa ležišta moguće je očekivati i na drugim lokacijama, uključujući i neposrednu blizinu arheoloških lokaliteta na kojima su utvrđene radionice za proizvodnju željeza datirane u kasnu antiku i rani srednji vijek. Mogućnost postojanja ležišta na ovim položajima može svjedočiti o razlogu odabira prostora izvan naselja za smještaj radionica, blizinu osnovnih resursa – rude, ali i drva.

Metoda eksploatacije ruda u prošlosti podrazumijevala bi kopanje plićih jama i/ili rovova koji su, ako slijede fizionomiju ležišta, mogli biti nepravilna oblika ili isprekidano postavljeni u okolišu. Obim ležišta mogao je značajno varirati, na što ukazuju reljefna obilježja u kojima se izmjenjuju plitke depresije različitih dimenzija i dubine s blagim uzdignućima. Prema primjeru nepotpuno razvijene rude s položaja Kalinovac

progressively and may cause the disappearance of deposits thus reducing the possibility of studying exploitation and use of ores in the past. Therefore, based on systematically collected data from the position Kalinovac – Hrastova greda 1–3, that showed the highest potential for the existence and development of bog iron ore, a deposit model was derived, with the aim of further predictive geoarchaeological analysis of the wider Podravina area. The analysis and reconstruction of the deposit at the Kalinovac – Hrastova greda site show that in the modern landscape of the Podravina region, the deposit formation is negatively affected by the newly created preconditions, primarily lowered groundwater levels and inhibited development due to intensive agricultural activity. Still, the ore formation process is active. The potential for the occurrence of deposits is highest in the shallow, spatially limited depressions, at a relative depth of 30/50 – 80/100 cm and an altitude from around 112 to 110 m, that is, in the zone where groundwater enriched with Fe fluctuates. Ores develop in the oxidative conditions zone in the silty loam and loam or within the wetland gley soil environment. Similar oxidative conditions during development (goethite as the main mineral phase), and thus a similar development mechanism, can be assumed for archaeological samples of ore (Brenko et al. 2021) found at sites related to iron production in the Podravina region (Velike Hlebine, Dedanovice, Virje – Sušine i Volarski breg). The deposits are probably irregular and predominately have a lenticular (nest-like) cross-section, which is dictated by the relief features and the physiognomy of the shallow depressions in which they develop. Given the similar natural conditions of the broader area of the Podravina region, especially the second Drava River terrace, the existence of this type of deposit is assumed in other locations, including the immediate vicinity of archaeological sites with workshops for iron production, dated to Late Antiquity and the Early Middle Ages. The possibility of deposits occurring in these positions may testify to the reason for choosing a space outside the settlement to accommodate the workshops, the proximity of the basic raw materials – ore, but also wood.

The method of ore exploitation in the past would involve digging shallow pits or trenches, which, if they follow the physiognomy of the deposit, could be irregularly shaped or intermittently placed in the environment. The volume of the deposits could vary considerably, as indicated by the relief

– Hrastova greda, ležišta su mogla biti maloga obima te sadržavati tek oko 150 kg rude. Pretpostavimo li dugoročniju eksploataciju rude, manji obim ležišta mogao je uvjetovati iskorištavanje više pojedinačnih ležišta. Analiza uzoraka ruda pronađenih u arheološkome kontekstu na lokalitetima Virje – Sušine i Volarski breg te Velike Hlebine i Dedanovice (Brenko et al. 2021) pokazuje značajne razlike u sastavu, poglavito zastupljenosti željezovih oksida. Ova pojava može se tumačiti eksploatacijom više različitih ležišta, ali i jedinstvenoga ležišta u kojemu, prema primjeru ležišta Kalinovac – Hrastova greda, sastav i kvaliteta rude mogu značajno varirati. Kemijska i mineraloška analiza uzoraka razvojnih faza rude s položaja Kalinovac – Hrastova greda zorno prikazuje da je sastav rude mogao varirati ovisno o dubini i uslojenosti ležišta, fazi razvoja, ali i mikrolokaciji leće. Odnos udjela željezovih i silicijevih oksida, odnosno kvaliteta i tehnološka iskoristivost rude u izravnoj je vezi s stadijem razvoja ruda. Ovakve, naizgled minimalne razlike, u prošlosti su mogle diktirati uspješnost postupka taljenja, odnosno proizvodnje spužvastoga željeza. Kemijska analiza nalaza ruda s arheoloških lokaliteta Virje – Sušine (Sonda 7–8) i Volarski breg (Sonda 2) pokazuje da su rude lošije kvalitete (≤ 50 mas. %) prisutne u arheološkom kontekstu datiranom u kraj 4. / početak 5. i 8. / početak 9. stoljeća, odnosno bile su prikupljane iz ležišta. Međutim, one nužno ne predstavljaju sirovine koje su bile upotrijebljene za proizvodnju željeza. Eksperimentalno testiranje tehnološke iskoristivosti rude s položaja Kalinovac – Hrastova greda pokazuju da visok udio jalovine, poglavito silikata, može onemogućiti formaciju spužvastoga željeza. Uzrok neuspjeha postupka taljenja u prošlosti je bilo moguće pretpostaviti i pripisati rudi na osnovi fizičkih karakteristika zgure tijekom i nakon postupka, što jasno pokazuje analiza zgure proizašle iz eksperimenta taljenja kalinovačke rude. Komparativna analiza fizičkih, mineraloških i kemijskih svojstava rude s položaja Kalinovac – Hrastova greda svjedoči da je kvalitetu i tehnološki značajniju zastupljenost jalovine (pjesak, glina, šljunak) moguće prepoznati na vizualnoj razini. Zasićenost rudnoga konglomerata globularnim nakupinama, koja označava unapredovali proces cementacije, odnosno pravilni razvoj rude, može predstavljati višu razinu kvalitete naspram jednoličnije strukture bez globularnih nakupina. Fizičke

features, in which shallow depressions of different dimensions and depths alternate with slight elevations. According to the example of incompletely developed ore from the position Kalinovac – Hrastova greda, the deposits could be of small size and contain only about 150 kg of ore. Assuming long-term ore exploitation, the smaller volume of the deposits could have conditioned the exploitation of several individual deposits. The analysis of ore samples found on archaeological sites of Virje – Sušine and Volarski breg, as well as Velike Hlebine and Dedanovice (Brenko et al. 2021), indicates significant differences in composition, especially the iron oxide content. This phenomenon could point to multiple ore sources, i.e. exploitation of several deposits or a single deposit, in which, according to the study of the Kalinovac – Hrastova greda, the composition of the ore and thus the quality can vary significantly. Chemical and mineralogical analysis of samples of ore development stages from the Kalinovac – Hrastova greda position clearly shows that the ore composition varies depending on the depth and stratification of the deposit, development stage and lens micro-location. The ratio of iron and silicon oxides in the ore composition, that is, the quality and technological usability of the ore is directly related to the advances in ore development. Such seemingly minimal differences in composition could have dictated the success of the smelting, i.e. the production of iron bloom in the past. Chemical analysis of ore finds from the archaeological sites Virje – Sušine (Trench 7–8) and Volarski breg (Trench 2) shows that low-quality ores ($\leq 50\%$ mass.) were collected from deposits as they are present in the archaeological context dated to the end of the 4th and beginning of 5th and the 8th and beginning of 9th century. However, they do not necessarily represent raw materials used for iron production. Experimental testing of technological usability of ore from the Kalinovac – Hrastova greda position show that a high proportion of gangue, primarily silica, can prevent the formation of iron bloom. The cause of the smelting process failure could be assumed and attributed to the ore in the past, based on the physical characteristics of slag during and after the process, which is clearly shown by the analysis of slag resulting from the Kalinovac ore smelting experiment. Comparative analysis of the physical, mineral and chemical properties of the ore from Kalinovac – Hrastova greda position has shown that the quality and technologically significant presence of

karakteristike mogle su biti vizualni indikator kvalitete rude u prošlosti te uz iskustveno znanje o talioničkome postupku potaknuti preradu rude, odnosno primjenu postupaka čišćenja u svrhu diskriminacije i odbacivanja loših dijelova rudnih konglomerata te poboljšanja svojstava rude. Postupci su mogli podrazumijevati mehaničko čišćenje i prebiranje te ispiranje. Arheološki uzorci rude lošije kvalitete mogli bi predstavljati odbačene, neiskorištene jalove dijelove rudnoga konglomerata. Kontekst u kojemu su pronađeni uzorci ruda i njihov mineralni sastav podržavaju tezu o primjeni postupaka pripreme u sklopu koje i diskriminaciju, odnosno odbacivanju jalovine iz ruda. Uzorci rude lošije kvalitete pronađeni su u sloju sustavno deponiranoga talioničkog otpada u sklopu proizvodne radionice datirane u kraj 4 – početak 5. stoljeća (Virje – Sušine, Sonda 7) te struktura vezanih uz nasebinski kontekst datiranih u 8 – početak 9. stoljeća (Virje – Volarski breg, Sonda 2; Sušine, Sonda 8). Mineraloška analiza pokazala je direktni utjecaj primjene jednoga od postupaka pripreme, prženja, kod dijela uzoraka iz oba konteksta što posredno može implicirati i uporabu drugih postupaka pripreme koji neće biti jasno zabilježeni u arheološkome zapisu. Druga mogućnost, upitnoga ishoda taljenja, je da uzorci ruda iz arheološkoga konteksta ne predstavljaju odbačene dijelove rudnoga konglomerata, nego su uz kvalitetnije rude bile upotrebljavane u postupku taljenja. Analiza arheoloških uzoraka zgure iz pripadajućega konteksta mogla bi dodatno razjasniti pitanje uporabe ruda lošije kvalitete.

Eksploatacija i uporaba ruda niske kvalitete, prema provedenome istraživanju, uvjetovana je neizbježnim, prirodnim svojstvima rude i karakterom ležišta močvarnih željeznih ruda. Međutim, pretpostavljena primjena postupaka priprema ruda u prošlosti svjedoči o svjesnome pokušaju ovladavanja prirodnim, nepovoljnim zadanostima i nepredvidivosti ishoda i to tehnološkom prilagodbom koja podrazumijeva primjenu dodatnih koraka u proizvodnji željeza sa svrhom oplemenjivanja ruda i osiguravanja prinosa u željezu.

Prijevod Translation TENA KARAVIDOVIĆ
Lektura Proofreading MARKO MARAS

gangue materials (sand, fine gravel and clay) can be recognized visually. The saturation of the ore conglomerate with globular accumulations, which indicates an advanced cementation process or proper ore development, may represent a higher level of quality when compared to a more uniform structure without globular agglomerations. Physical characteristics could be a visual indicator of ore quality in the past and combined with experiential knowledge on smelting, prompt the ore dressing to discriminate and reject bad parts of ore conglomerates and improve ore properties. Ore dressing could include mechanical cleaning, screening and washing of ore conglomerates. Archaeological samples of lower quality ore could represent discarded, unused barren parts of the ore conglomerate. The context of archaeological ore samples and their mineral composition support the thesis of the application of preparation procedures, with discrimination and rejection of gangue materials from ore conglomerates. Lower quality ores were found in a layer of systematically deposited smelting waste within an iron production workshop dated to the 4th and beginning of 5th centuries (Virje – Sušine, Trench 7) and structures related to the settlement context dated to the 8th and beginning of 9th centuries (Virje – Volarski breg, Trench 2; Sušine, Trench 8). The mineralogical analysis of some samples from both contexts showed a direct impact of the application of one of the preparation procedures, roasting, which may indirectly imply the use of other preparation procedures that will not be clearly identifiable in the archaeological record. Another possibility, with questionable smelting outcomes, is that ore samples from the archaeological context do not represent discarded parts of the ore conglomerate but were used in the smelting process along with higher quality ores. Analysis of archaeological slag samples from the corresponding contexts could further clarify the issue of the use of the poorer quality ores.

Procurement and use of low-quality ores are conditioned by the inevitable, natural properties of the ore and the character of bog iron ore deposits. However, the presumed application of ore preparation procedures in the past testifies to a conscious attempt of mastering unfavourable preconditions and unpredictability of outcomes with a technological adaptation, which involves additional steps in iron production to improve the ore and ensure iron yield.

INTERNETSKI IZVORI INTERNET SOURCES

DMR 2020 – Digitalni model reljefa, EarthData, www.earthdata.nasa.gov

Geoportal – Državna geodetska uprava, Digitalni ortofoto (DOF) 2018, <https://geoportal.dgu.hr>

ENVI – Atlas okoliša Ministarstva gospodarstva i održivog razvoja, Zavod za zaštitu okoliša i prirode, <http://envi.azo.hr/> (16.09.2021.)

LITERATURA BIBLIOGRAPHY

Bachman, H. G. 2016, *The identification of slags from archaeological sites*, University College London Institute of Archaeology Publications, Occasional Publication No. 6, Routledge, London.

Banning, A. 2008, Bog Iron Ores and their Potential Role in Arsenic Dynamics: An Overview and a 'Paleo Example', *Engineering in Life Sciences*, Vol. 8(6), 641–649. <https://doi.org/10.1002/elsc.200800014>

Botić, K. 2021, Absolute dating of the Virje and Hlebne sites, in: *Interdisciplinary Research into Iron Metallurgy along the Drava River in Croatia – The Transfer project*, Sekelj Ivančan T., Karavidović T. (eds.), Archaeopress Publishing Ltd., Oxford, 92–100.

Brenko, T., Borojević Šoštarić, S., Ružičić, S., Sekelj Ivančan, T. 2020, Evidence for the formation of bog iron ore in soils of the Podravina region, NE Croatia: Geochemical and mineralogical study, *Quaternary International*, Vol. 536, 13–29. <https://doi.org/10.1016/j.quaint.2019.11.033>

Brenko, T., Borojević Šoštarić, S., Karavidović, T., Ružičić, S., Sekelj Ivančan, T. 2021, Geochemical and mineralogical correlations between the bog iron ores and roasted iron ores of the Podravina region, Croatia, *Catena*, Vol. 204, 105353.

<https://doi.org/10.1016/j.catena.2021.105353>

Brkić, Ž., Briški, M. 2018, Hydrogeology of the western part of the Drava Basin in Croatia, *Journal of Maps*, Vol. 14(2), 173–177.

<https://doi.org/10.1080/17445647.2018.1445043>

Butorac, A., Kisić, I., Butorac, J., Barčić, J. 2000, Međusobni odnosi obrade i gnojidbe tla u uzgoju šećerne repe na lessive pseudogleju donje Podravine, *Agriculturae Conspectus Scientificus*, Vol. 65(3), 143–151.

Charlton, M. F., Crew, P., Rehren, T., Shennan, S. J. 2010, Explaining the evolution of ironmaking recipes – An example from northwest Wales, *Journal of Anthropological Archaeology*, Vol. 29(3), 352–367. <https://doi.org/10.1016/j.jaa.2010.05.001>

Crew, P. 1991a, Experimental iron smelting and bloom smithing, linked to archaeological evidence from two sites in north Wales, in: *Archaeologie Experimentale: Tome 1 - Le feu, métal et céramique*, Actes du Colloque International Expérimentation en archéologie: Bilan et Perspectives, Archéodrome de Beaune les 6-9 avril 1988, (s/ed.), Editions Errance, Paris, 160–164.

Crew, P. 1991b, The experimental production of prehistoric bar iron, *Historical Metallurgy*, Vol. 25(1), 21–36.

Crew, P. 2000, The influence of clay and charcoal ash on bloomery slags, in: *Il Ferro nelle Alpi. Giacimenti, miniere e metallurgia dall'antichità al XVI secolo. Atti del convegno, / Iron in the Alps. Deposits, mines and metallurgy from antiquity to the XVI century. Proceedings of the conference*, Cucini Tizzoni C., Tizzoni M. (eds.), Comune di Bienno, Bienno, 38–48.

Crew, P. 2007, CaO enhancement in slags: the influence of fluxing or fuel ash?, in: *Early Ironworking in Europe II. Archaeology, technology and experiment*, Abstracts of the Second International Conference, 17-21st September 2007, Crew P., Crew S. (eds.), Plas Tan y Bwlch Occasional Paper No. 4, Plas Tan y Bwlch, Maentwrog, 50–52.

Crew, P., Salter, C. J. 1991, Comparative Data from Iron Smelting and Smithing Experiments, in: *From Bloom to Knife. International Symposium of the Comité pour la sidérurgie ancienne de l'UISPP*, Kielce – Ameliowka 18–22 September 1989, Materiały Archeologiczne XXVI, Archaeological Museum, Kraków, 15–22.

Crew, P., Charlton, M. 2007, The anatomy of a furnace... and some of its ramifications, in: *Metals and Mines: Studies in Archaeometallurgy*, Selected papers from the conference Metallurgy: a touchstone for cross-cultural interactions, British Museum London, 28–30 April 2005, La Niece S., Hook D., Craddock P. (eds.), Archetype Publications – British Museum, London, 219–225.

Crew, P., Charlton, M., Dillmann, P., Fluzin, P., Salter, C., Truffaut, E. 2011, Cast iron from a bloomery furnace, in: *The Archaeometallurgy of Iron – Recent Developments in Archaeological and Scientific Research*, Hošek J., Cleere H., Mihok L. (eds.), Archeologický ústav Akademie věd České republiky, Prague, 237–262.

De Geyter, G., Vandengergh, R. E., Verdonck, L., Stoops, G. 1985, Mineralogy of holocene bog-iron ore in northern Belgium, *Neues Jahrbuch für Mineralogie, Abhandlungen*, Vol. 153, 1–17.

Feletar, D. 1989, *Podravina. Općine Đurđevac, Koprivnica i Ludbreg u prošlosti i sadašnjosti. Knjiga 1: Povijesno-geografski pregled od paleolita do 1945. godine*, 2. izd., Muzej grada Koprivnice, Koprivnica.

Graupner, A. 1982, *Raseneisenstein in Niedersachsen. Entstehung, Vorkommen, Zusammensetzung und Verwendung*, Forschungen zur niedersächsischen Landeskunde 118, Kommissionsverlag Göttinger Tageblatt GmbH & Co. KG., Göttingen.

Husnjak, S. 2014, *Sistematika tala Hrvatske*, Hrvatska Sveučilišna Naklada, Zagreb.

Joosten, C. 2004, *Technology of Early Historical Iron Production in the Netherlands*, Geoarchaeological and Bioarchaeological Studies 2, Institute for Geo- and Bioarchaeology, Vrije Universiteit, Amsterdam.

Joosten, I., Jansen, J., Kars, H. 1998, Geochemistry and the past: estimation of the output of a Germanic iron production site in the Netherlands, *Journal of Geochemical Exploration*, Vol. 62(1–3), 129–137. [https://doi.org/10.1016/S0375-6742\(97\)00043-5](https://doi.org/10.1016/S0375-6742(97)00043-5)

Kaczorek, D., Sommer, M. 2003, Micromorphology, chemistry and mineralogy of bog iron ores from Poland, *Catena*, Vol. 54(3), 393–402. [https://doi.org/10.1016/S0341-8162\(03\)00133-4](https://doi.org/10.1016/S0341-8162(03)00133-4)

- Kaczorek, D., Zagórski, Z.** 2007, Micromorphological characteristics of the bsm horizon in soils with bog iron ore, *Polish Journal of Soil Science*, Vol. XL(1), 81–87.
- Kaczorek, D., Sommer, M., Andruschkewitsch, I., Oktaba, L., Czerwinski, Z., Stahr, K.** 2004, A comparative micromorphological and chemical study of "Rasseneisenstein" (bog iron ore) and "Ortstein", *Geoderma*, Vol. 121(1–2), 83–94. <https://doi.org/10.1016/j.geoderma.2003.10.005>
- Karavidović, T.** 2020, Močvarna željezna ruda – eksperimentalno testiranje utjecaja prženja rude na postupak taljenja i krajnji proizvod / Bog iron ore – experimental testing of the impact of ore roasting on the smelting process and the end product, *Annales Instituti Archaeologici*, Vol. XVI, 143–152.
- Karavidović, T.** 2021a, *Makroskopska analiza otpada vezanog uz proizvodnju željeza s arheološkog nalazišta Kalinovac – Hrastova Greda (Sonda 1 – 3)*, Zagreb (neobjavljeni rukopis pohranjen u Institutu za arheologiju, Zagreb). http://transfer.iarh.hr/images/Kalinovac_hg_izvje%C5%A1%C4%87e_web.pdf
- Karavidović, T.** 2021b, Methodological framework for experiments related to bloomery iron production procedures: ore preparation and smelting, in: *Interdisciplinary Research into Iron Metallurgy along the Drava River in Croatia – The Transfer project*, Sekelj Ivančan T., Karavidović T. (eds.), Archaeopress Publishing Ltd., Oxford, 233–247. doi: 10.32028/9781803271026-12
- Kiss, T., Andraši, G.** 2019, Evolution of The Drava Floodplain in Hungary in the last 100 years, in: *The Drava River. Environmental problems and solutions*, Lóczy D. (ed.), Springer Geography, Cham, 157–176.
- Kudelić, A., Sirovica, F., Miloglav, I., Tresić Pavičić, D.** 2017, Terenski pregled gornje Podravine – analiza učestalosti i distribucije srednjovjekovnog površinskog materijala, in: *Medieval Settlements in the Light of the Archaeological Sources. Zbornik radova drugog međunarodnog znanstvenog skupa srednjovjekovne arheologije Instituta za arheologiju Zagreb, 2. – 3. lipnja 2015.*, Sekelj Ivančan T., Tkalčec T. Krznar S., Belaj J. (eds.) Zbornik Instituta za arheologiju 6, Institut za arheologiju, Zagreb, 473–481.
- Landuydt, C. J.** 1990, Micromorphology of iron minerals from bog ores of the Belgian Campine area, *Developments in Soil Science*, Vol. 19, 289–294. [https://doi.org/10.1016/S0166-2481\(08\)70340-4](https://doi.org/10.1016/S0166-2481(08)70340-4)
- Manasse, A., Mellini, M.** 2002, Chemical and textural characterization of medieval slags from the Massa Marittima smelting sites (Tuscany, Italy), *Journal of Cultural Heritage*, Vol. 3(3), 187–198. [https://doi.org/10.1016/S1296-2074\(02\)01176-7](https://doi.org/10.1016/S1296-2074(02)01176-7)
- Morton, G. R., Wingrove, J.** 1969, Constitution of bloomery slags, part 1: Roman, *Journal of the Iron and Steel Institute*, Vol. 207, 1556–1564.
- Mušić, B., Medarić, I., Sekelj Ivančan, T.** 2019, Geofizička istraživanja srednjovjekovnoga lokaliteta Kalinovac – Hrastova greda 1, *Annales Instituti Archaeologici*, Vol. XV, 117–122.
- Petrić, H.** 2012, *Pogranična društva i okoliš. Varaždinski generalat i Križevačka županija u 17. stoljeću*, Meridijani – Društvo za Hrvatsku Ekonomsku povijest i Historiju, Zagreb.
- Petrić, H.** 2013, Poplave i pogranična naselja od 17. do 19. stoljeća – primjer rijeke Drave, in: *Bertošin zbornik II. Zbornik u čast Miroslava Bertoše*, Jurković I. (ed.), Sveučilište Jurja Dobrile u Puli – Državni arhiv u Pazinu, Pula–Pazin, 413–429.
- Petrić, H., Tamás, E. A., Lóczy, D.** 2019, Flood history and river regulation, in: *The Drava River. Environmental problems and solutions*, Lóczy D. (ed.), Springer Geography, Cham, 105–124.
- Pleiner, R.** 2000, *Iron in archaeology. The European Bloomery Smelters*, Archeologický ústav Akademie věd České republiky, Praha.
- Puttkammer, T.** 2012, *Auf den Spuren der Germanen. Begleitband zur Wanderausstellung*, Museum der Westlausitz, Kamenz.
- Ramanaidou, E., Wells, M. A.** 2014, Sedimentary hosted iron ores, in: *Treatise on Geochemistry 13c*, 2nd edition, Holland H. D., Turekian K. K. (eds.), Elsevier, Oxford, 313–355. <https://doi.org/10.1016/B978-0-08-095975-7.01115-3>
- Seernels, V., Crew, P.** 1997, Ore-slag relationships from experimentally smelted bog-iron ore, in: *Early Ironworking in Europe, archaeology and experiment*, Crew P., Crew S. (eds.), Abstracts of the International Conference, Plas Tan y Bwlch Occasional Paper No. 3, Plas Tan y Bwlch, Maentwrog, 78–82.
- Sekelj Ivančan, T.** 2020, *Izvješće o arheološkom iskopavanju lokaliteta Kalinovac – Hrastova greda 1*, Zagreb (neobjavljeni rukopis pohranjen u Institutu za arheologiju, Zagreb).
- Sekelj Ivančan, T.** 2021, The Archaeological remains of settlement at sites with smelting workshop features in the Podravina region, in: *Interdisciplinary Research into Iron Metallurgy along the Drava River in Croatia – The Transfer project*, Sekelj Ivančan T., Karavidović T. (eds.), Archaeopress Publishing Ltd., Oxford, 146–194. doi: 10.32028/9781803271026-8
- Sekelj Ivančan, T., Karavidović, T.** 2021, Archaeological record of Iron Metallurgy along the Drava River, in: *Interdisciplinary Research into Iron Metallurgy along the Drava River in Croatia – The Transfer project*, Sekelj Ivančan T., Karavidović T. (eds.), Archaeopress Publishing Ltd., Oxford, 43–91. doi: 10.32028/9781803271026-4
- Sekelj Ivančan, T., Marković, T.** 2017, The primary processing of iron in the Drava river basin during the Late Antiquity and the Early Middle Ages – the source of raw materials, in: *Archaeotechnology studies. Raw material exploitation from prehistory to the Middle Ages*, Vitezović S., Antonović D. (eds.), Srpsko arheološko društvo, Beograd, 143–160.
- Senn, M., Gfeller, U., Guénette-Beck, B., Lienemann, P., Ulrich, A.** 2010, Tools to qualify experiments with bloomery furnaces, *Archaeometry*, Vol. 52(1), 131–145. <https://doi.org/10.1111/j.1475-4754.2009.00461.x>
- Stanton, M. R., Yager, D. B., Fey, D. L., Wright, W. G.** 2007, Ch. E14 Formation and Geochemical significance of Iron Bog Deposits, in: *Integrated Investigations of Environmental Effects of Historical Mining in the Animas River Watershed, San Juan County, Colorado*, Church S. E., von Guerard P., Finger S. E. (eds.), U.S. Geological Survey Professional Paper 1651(2), U.S. Geological Survey, Reston (VA), 693–720.

- Sitschick, H., Ludwig, F., Wetzel, E., Luckert, J., Höding, T.** 2005, Raseneisenerz – auch in Brandenburg ein mineralischer Rohstoff mit bedeutender wirtschaftlicher Vergangenheit, *Brandenburgische Geowissenschaftliche Beiträge*, Vol. 12(1–2), 119–128.
- Slukan-Altić, M.** 2002, Hidroregulacije Drave i njezini utjecaji na transformaciju prirodnog i kulturnog pejzaža Podravine, *Podravina: Časopis za multidisciplinarna istraživanja*, Vol. 1(2), 128–152.
- Stoops, G.** 1983, SEM and light microscopic observations of minerals in bog-ores of the Belgian Campine, *Geoderma*, Vol. 30(1), 179–186. [https://doi.org/10.1016/0016-7061\(83\)90065-4](https://doi.org/10.1016/0016-7061(83)90065-4)
- Sperling, D.** 2003, *Rohstoffgewinnung und Altbergbau im Förderraum Calau*, Beiträge zur Geschichte des Bergbaus in der Niederlausitz, 3., Förderverein Kulturlandschaft Niederlausitz, Cottbus.
- Thelemann, M., Bebermeier, W., Hoelzmann, P., Lehnhardt, E.** 2017, Bog iron ore as a resource for prehistoric iron production in Central Europe – A case study of the Widawa catchment area in eastern Silesia, Poland, *Catena*, Vol. 149(1), 474–490. <https://doi.org/10.1016/j.catena.2016.04.002>
- Thiele, Á.** 2010, Smelting experiments in the early medieval fajszi-type bloomery and the metallurgy of iron bloom, *Periodica Polytechnica Mechanical Engineering*, Vol. 54(2), 99–104. <https://doi.org/10.3311/pp.me.2010-2.07>
- Thiele, Á., Török, B.** 2011, Vastermelés, Vaskihozatal És A Kohósított Gyepvasércek Minimálisan Szükséges Vastartalma Az Avar És Árpád-Kori Vasbucakohászatban, *Archeometriai Műhely*, Vol. VIII(4), 345–350.
- Tylecote, R. F., Austin, J. N., Wraight, A. E.** 1971, The mechanism of the bloomery process in shaft furnace, *Journal of the Iron and Steel Institute*, Vol. 209, 342–363.
- Valent, I., Zvijerac, I., Sekelj Ivančan, T.** 2017, Topografija arheoloških lokaliteta s talioničkom djelatnošću na prostoru Podravine, *Podravina: Časopis za multidisciplinarna istraživanja*, Vol. 16(32), 5–25.
- Valent, I., Tkalčec, T., Krznar, S.** 2021, Methodological approach to detecting archaeological sites with metallurgical activities on the territory of the River Drava Basin and the possibilities of analysing the collected information, in: *Interdisciplinary Research into Iron Metallurgy along the Drava River in Croatia. The Transfer project*, Sekelj Ivančan T., Karavidović T. (eds.), Archaeopress Publishing Ltd., Oxford, 1–17. doi: 10.32028/9781803271026-2
- Wang, L., Liu, H.** 2006, An efficient method for identifying and filling surface depressions in digital elevation models for hydrologic analysis and modelling, *International Journal of Geographical Information Science*, Vol. 20(2), 193–213. <https://doi.org/10.1080/13658810500433453>
- Werońska, A.** 2009, Wpływ warunków środowiskowych na powstawanie holoceńskich rud żelaza, *Gospodarka Surowcami Mineralnymi*, Vol. 25(2), 23–36.
- Zwahr, H., Granitzki, K., Schomburg, J., Zander, H.-J.** 2000, Quartäres Raseneisenerz in Mecklenburg-Vorpommern - Genese Stoffbestand, Vorkommen und Nutzung, *Brandenburgische Geowissenschaftliche Beiträge*, Vol. 7, 83–91.

