

Similarities and differences between 7th and 8th-century pottery as shown by archaeological sites in the vicinity of Hlebine

Sekelj Ivančan, Tajana; Valent, Ivan

Source / Izvornik: **Avari i Slaveni, Dvije strane pojasnog jezičca - Avari na sjeveru i jugu Kaganata // Avars and Slavs, Two Sides of a Belt Strap end - Avars on the North and the South of the Khaganate, 2022, 5, 62 - 75**

Conference paper / Rad u zborniku

Publication status / Verzija rada: **Published version / Objavljena verzija rada (izdavačev PDF)**

Permanent link / Trajna poveznica: <https://urn.nsk.hr/urn:nbn:hr:291:043553>

Rights / Prava: [In copyright](#)/[Zaštićeno autorskim pravom.](#)

Download date / Datum preuzimanja: **2024-11-12**

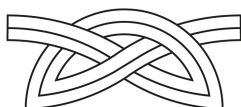

INSTITUT ZA
ARHEOLOGIJU

Repository / Repozitorij:

[RIARH - Repository of the Institute of archaeology](#)



dr. sc. TAJANA SEKELJ IVANČAN
Institut za arheologiju
Ljudevita Gaja 32, 10000 Zagreb
tsivančan@iarh.hr



IVAN VALENT, mag. arh
Muzej grada Koprivnice
Trg dr. L. Brozovića 1, 48000 Koprivnica
ivalent@muzej-koprivnica.hr



Similarities and differences between 7th and 8th century pottery on the example of the archaeological sites in the vicinity of Hlebine

International scientific conference:
TWO SIDES OF A BELT STRAP END:
AVARS ON THE NORTH AND THE SOUTH OF THE KHAGANAT
Vinkovci, 6th-7th February 2020



Hlebine - Dedanovice

Hlebine - Velike Hlebine

S 2

S 2a

S 1

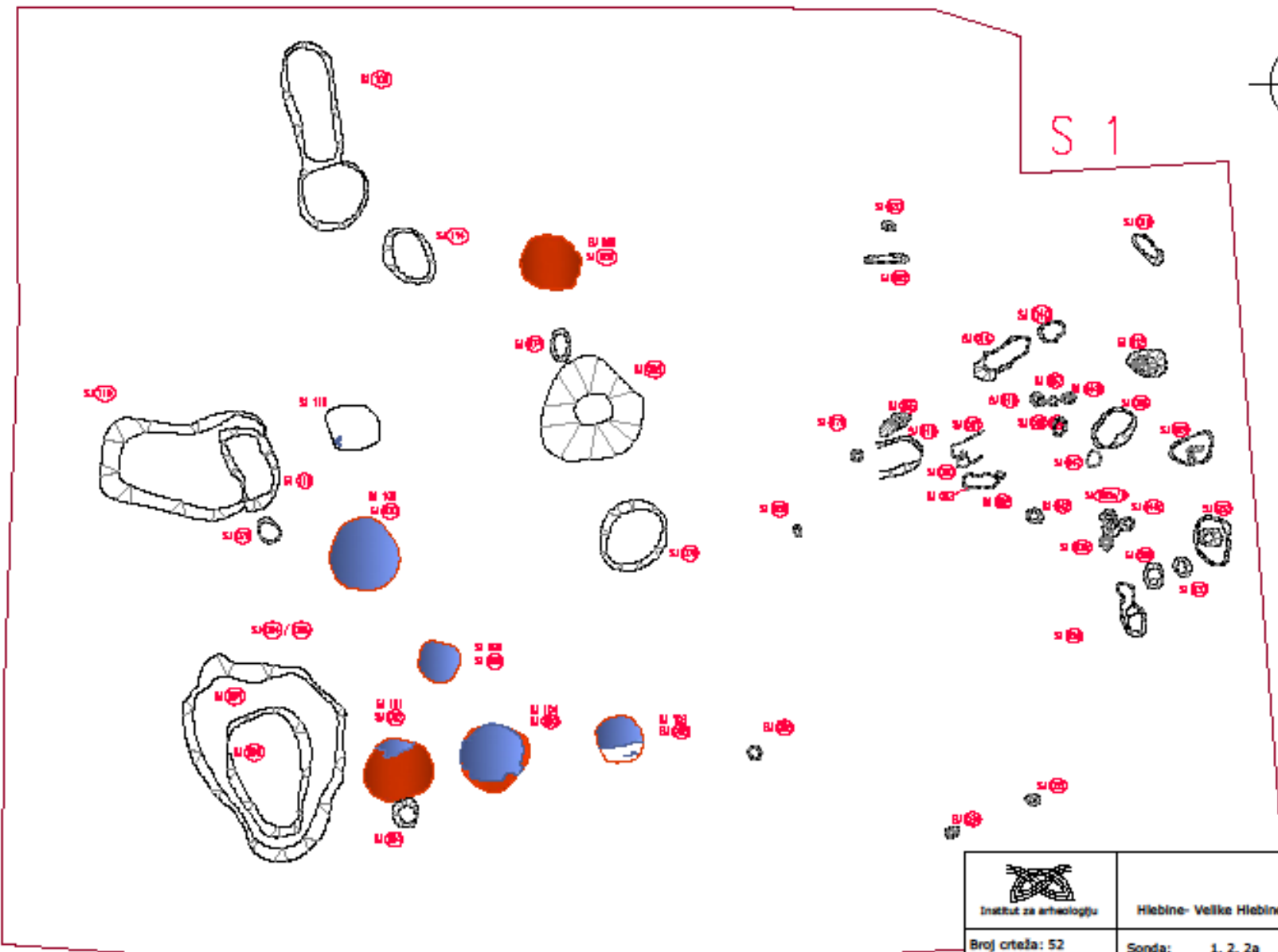
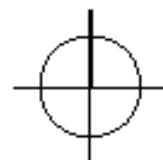

LEGENDA:

- zapečena zemlja
- jače zapečena zemlja

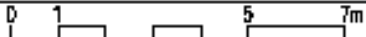
 Institut za arheologiju	Hlebine- Velike Hlebine 2017.
Broj crteža: 52	Sonda: 1, 2, 2a
Stratigrafska jedinica: Položaj ukopa unutar Sondi 1 i 2	
Datum: listopad 2017.	Autor crteža: Kristina Turkalj
Mjerilo: 1:150	

Hlebine – Velike Hlebine 2017.

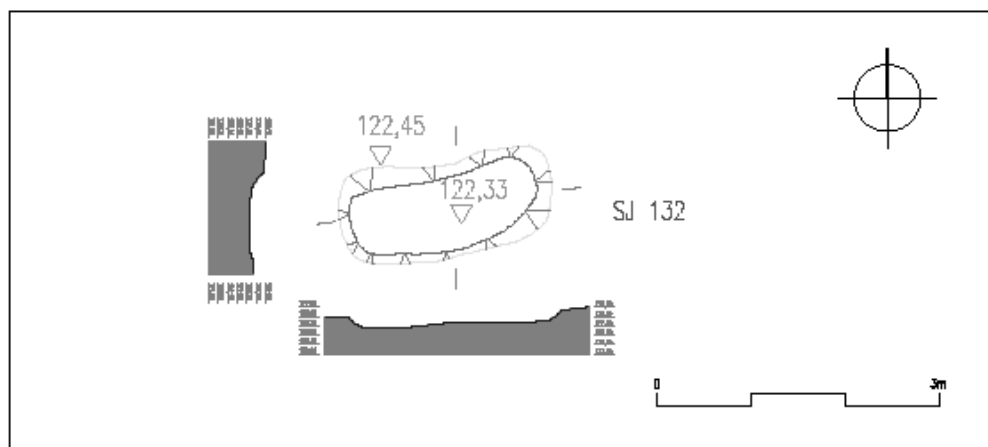
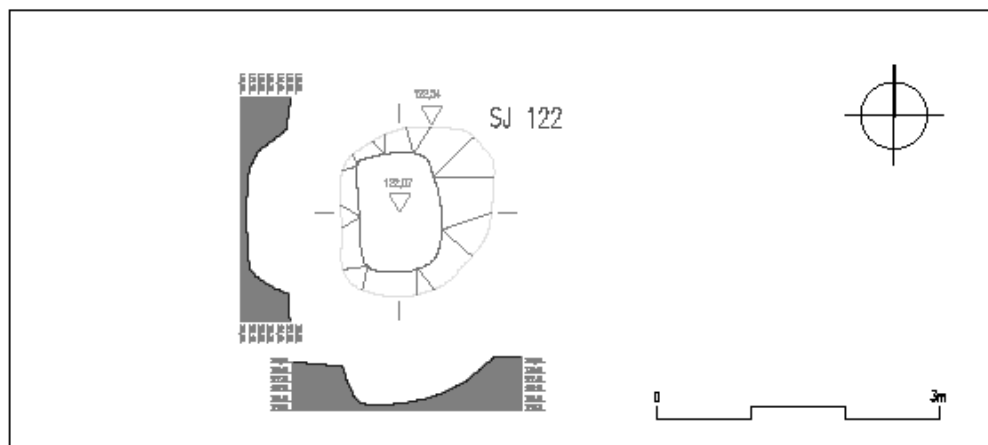
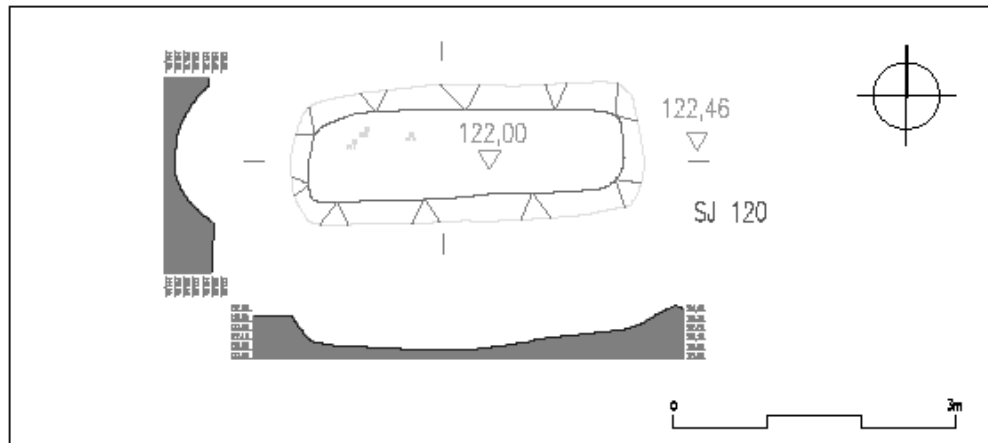
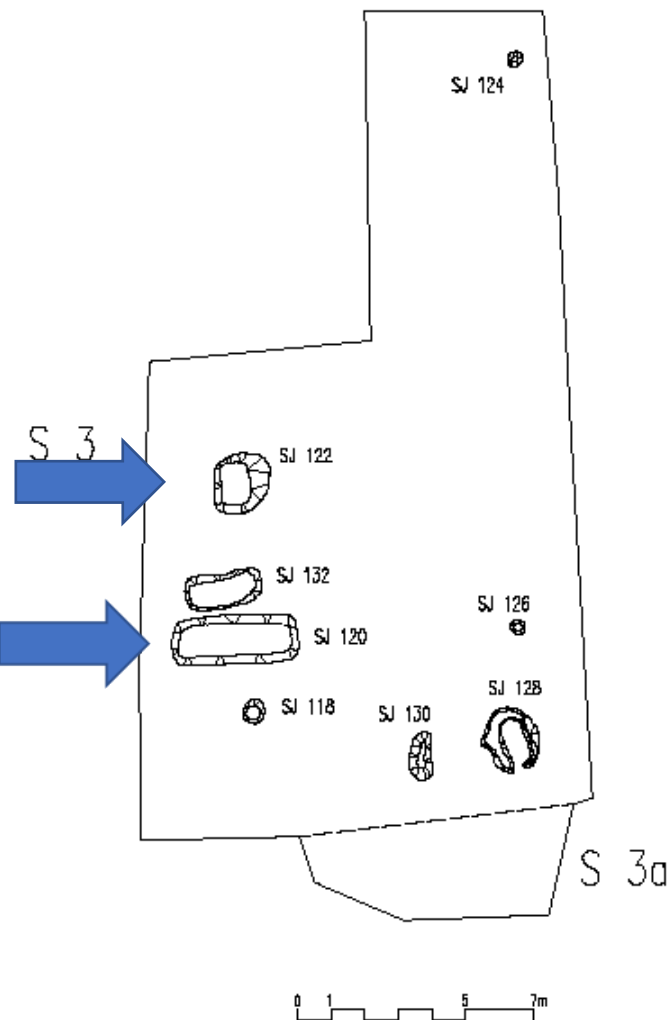
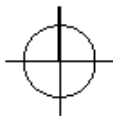

T. S. Ivančan 2019, Ostaci ranosrednjovjekovnog naselja na lokalitetu Hlebine – Velike Hlebine, Podravina – časopis za multidisciplinarna istraživanja, Vol 18, br. 36, 5-20.

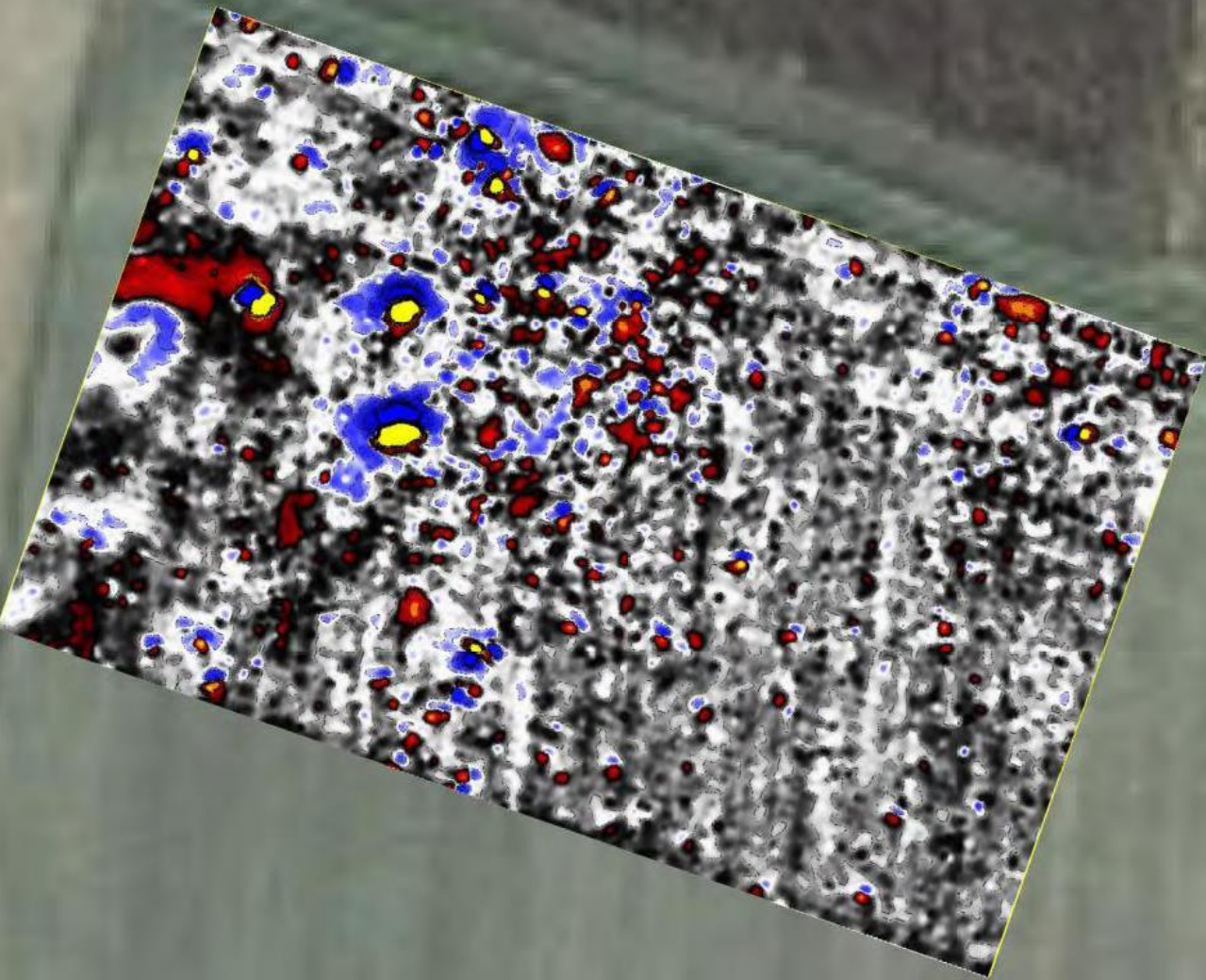

Hlebine – Dedanovice 2017

Mušič et. al 2017(Unpublished Report)

0

40m

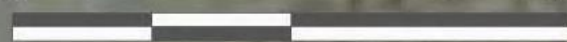

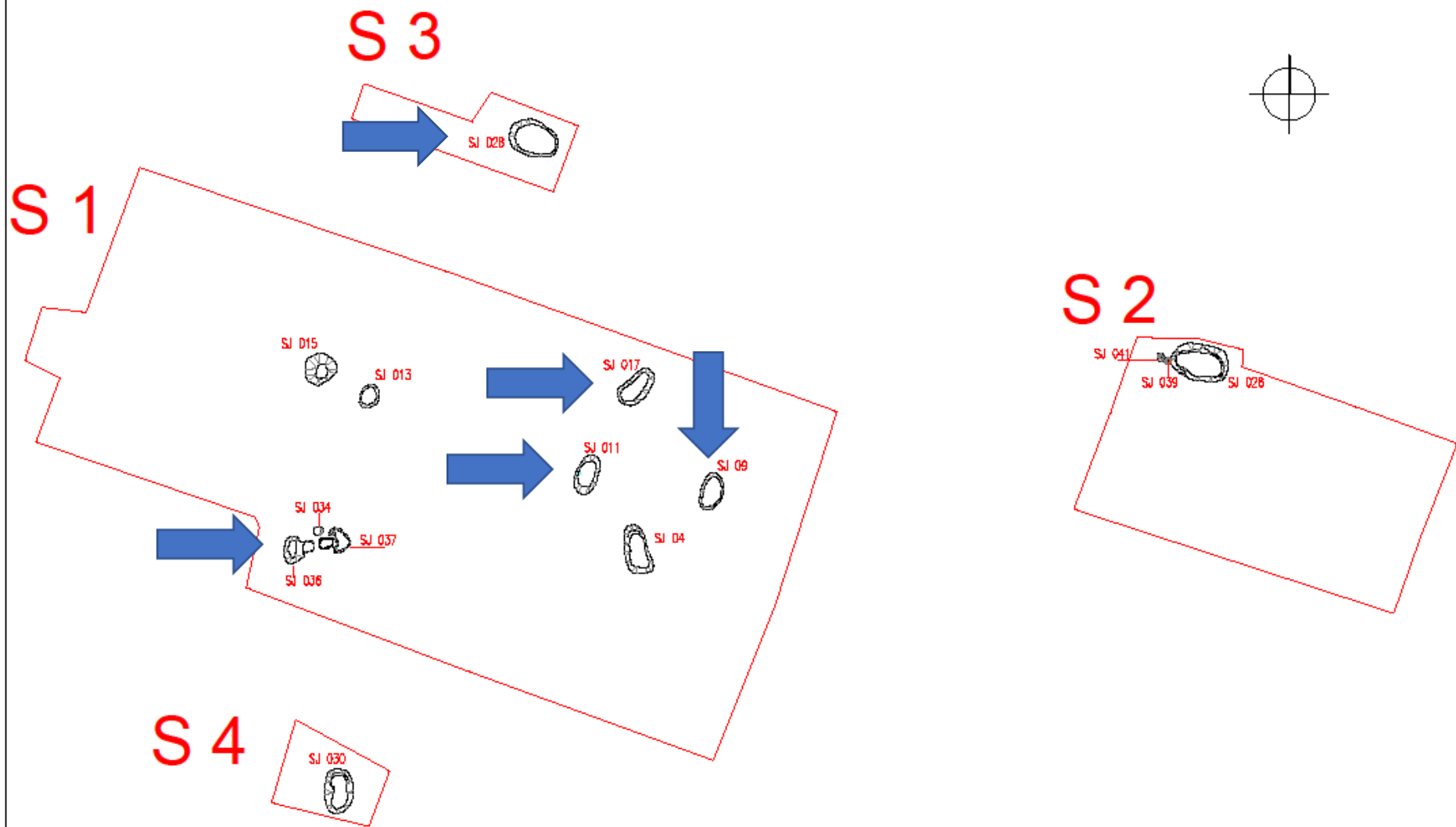

Hlebine – Dedanovice 2018.

Drawing: K. Turkalj, IARH

 Institut za arheologiju	Hlebine - Dedanovice 2018.
Broj crteža: 19	Sonda: 1, 2, 3, 4
Stratigrafska jedinica: Tloort ukope objekata	
Datum: studeni 2018.	Autor crteža: Kristina Turkalj
Mjerilo: 1:200	0 5 10m

68.3 (1 sigma) cal AD 659 – 694 0.705

703 – 707 0.035

SU 10

746 – 763 0.259

95.4 (2. sigma) cal AD 653 – 725 0.748

738 – 768 0.252

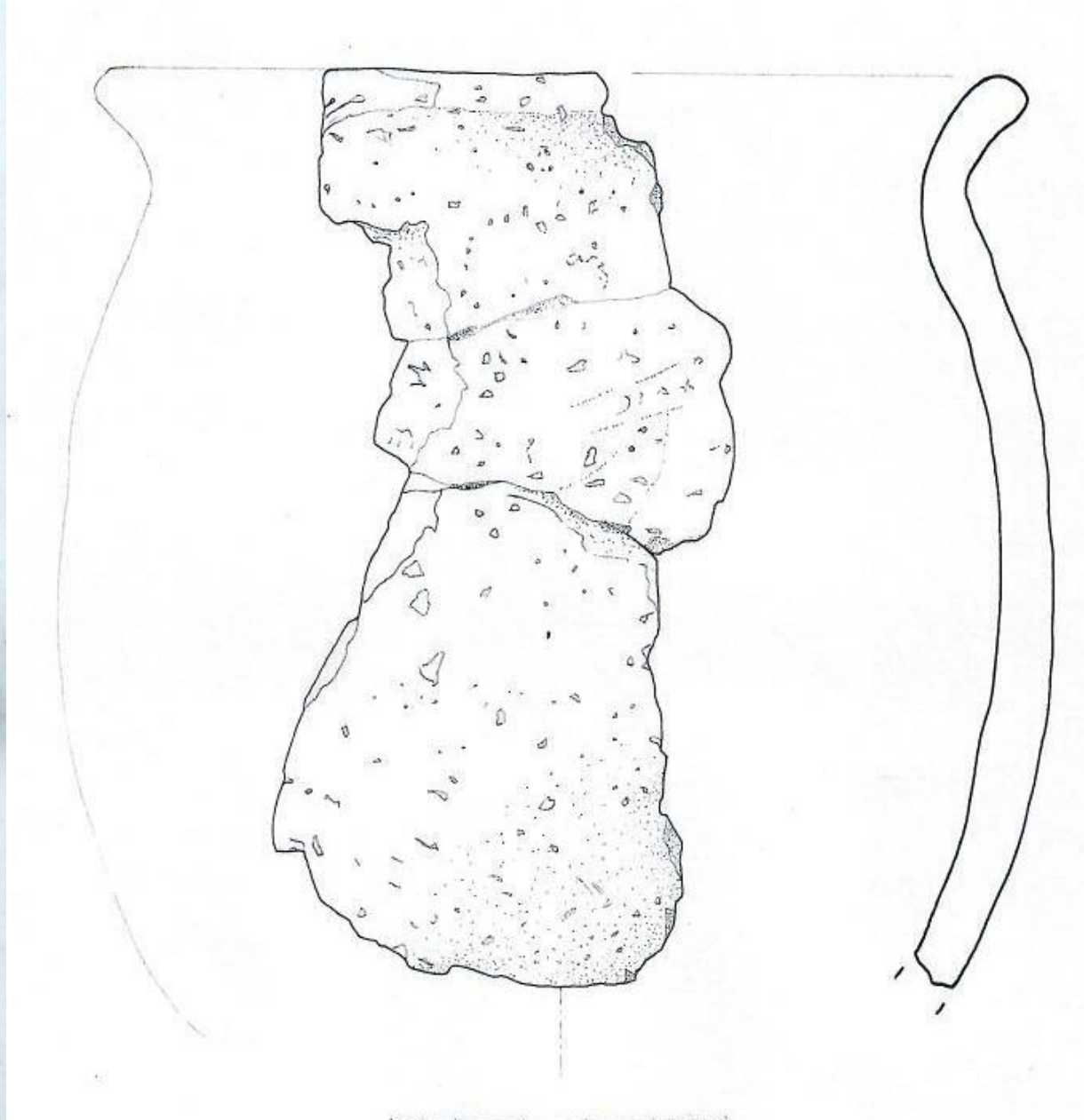

SU 27

68.3 (1 sigma) cal AD	647 – 671	1.000
95.4 (2. sigme) cal AD	616 – 690	0.986
	752 – 760	0.014

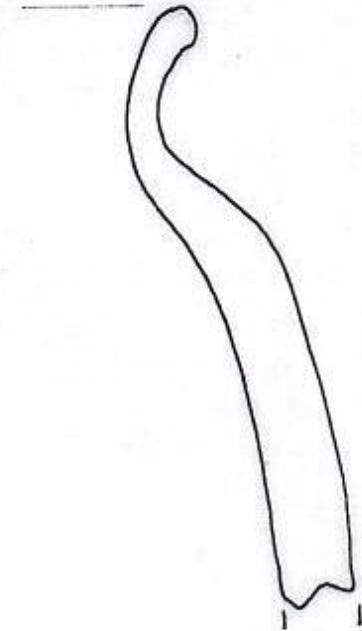
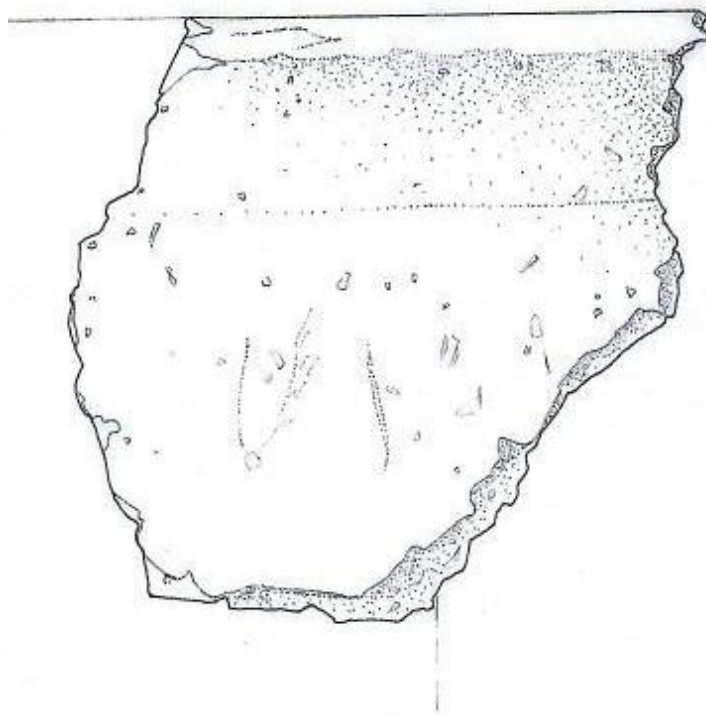

Hlebine – Dedanovice 2018

Pottery representation diagram

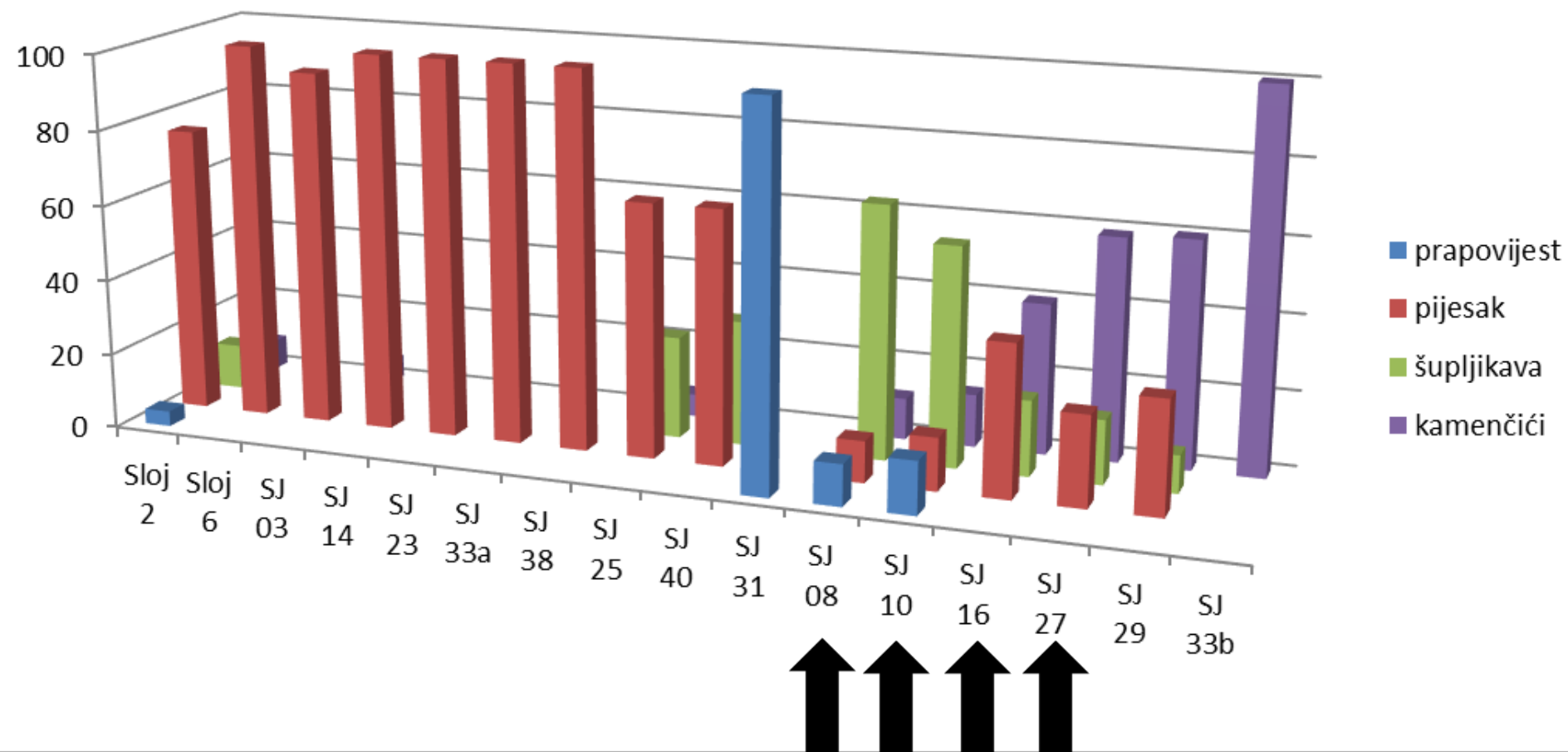

SU 8

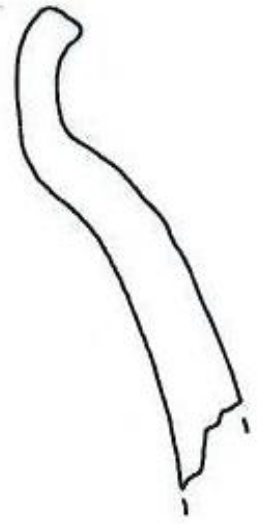
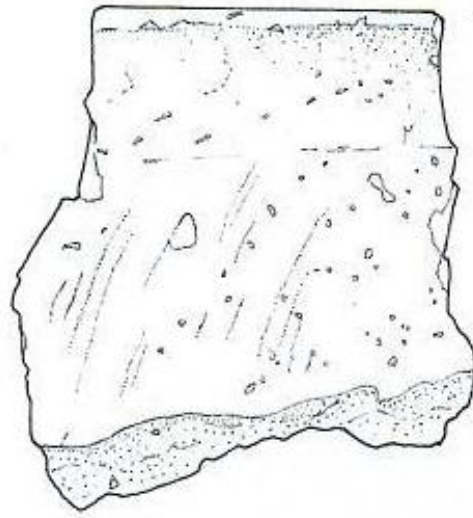

SU 27

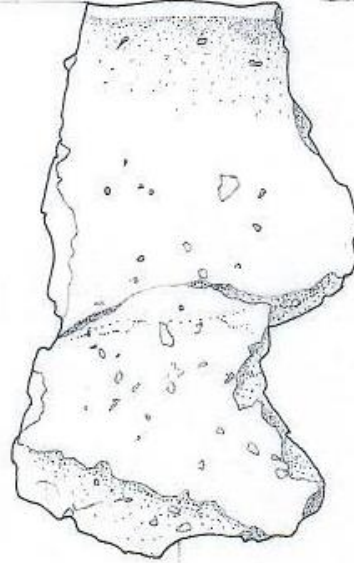

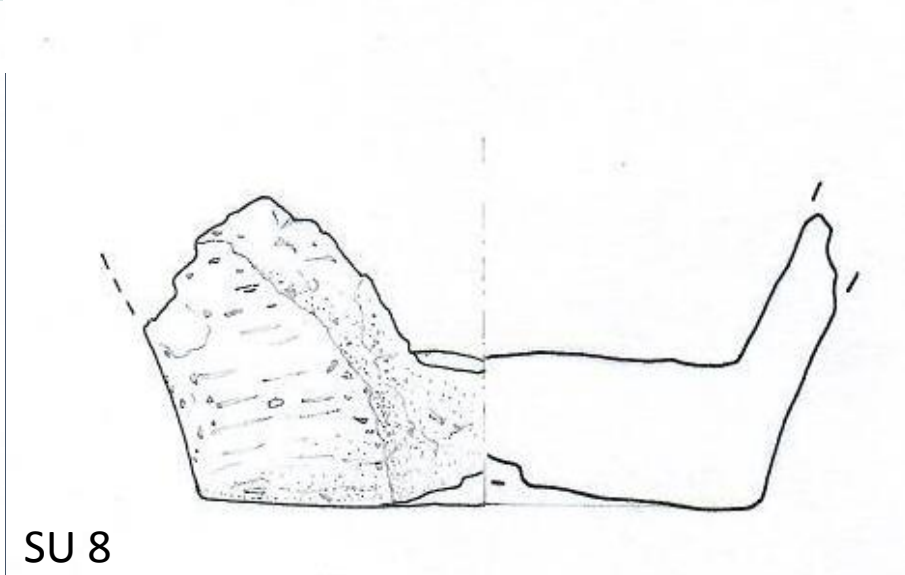
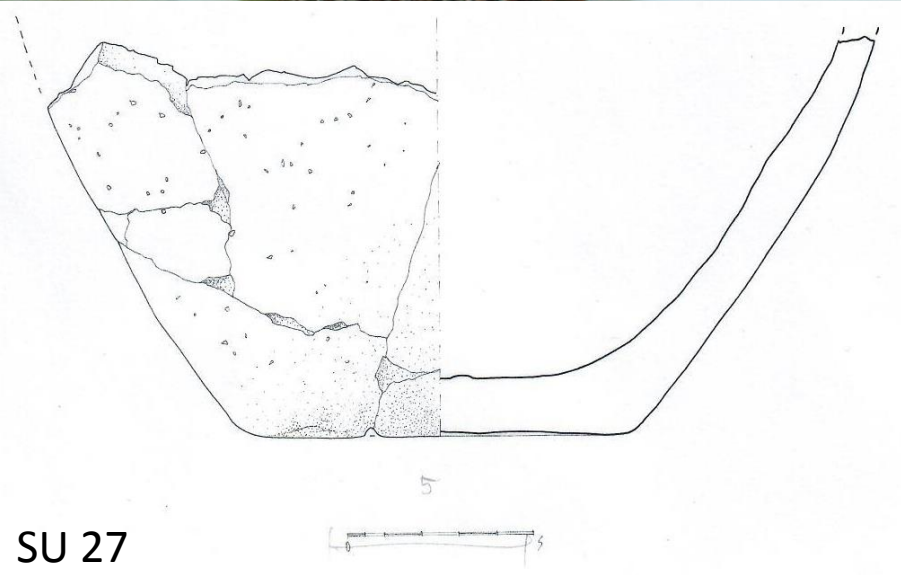

Pottery characteristics

- differences and similarities -

Type 1

- **Organic material in facture**
- Made by hand
- Vertical production marks
- Similar shapes
- Slightly raised lower surfaces of bottoms
- Decoration in one case (double-wave line)

Type 2

- **Small pebbles in facture**
- Made by hand
- Vertical production marks
- Similar shapes
- Flat lower surfaces of bottoms
- No decoration

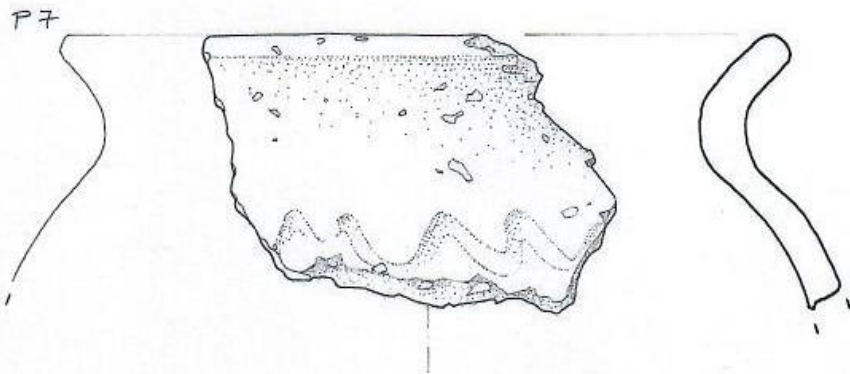

SU 27



Common nominator from different context (US 8, 10, 16, 27)



SU 16
U – 45/1b



Furnaces SU 31, SU 33 (Photo: T. S. Ivančan)

SU 31 b

68.3 (1 sigma) cal AD 647 – 668 1.000

95.4 (2. sigme) cal AD 616 – 686 1.000

SU 33 b

68.3 (1 sigma) cal AD 643 – 665 1.000

95.4 (2. sigme) cal AD 614 – 676 1.000

Hlebine – Velike Hebine 2017 Trench 3

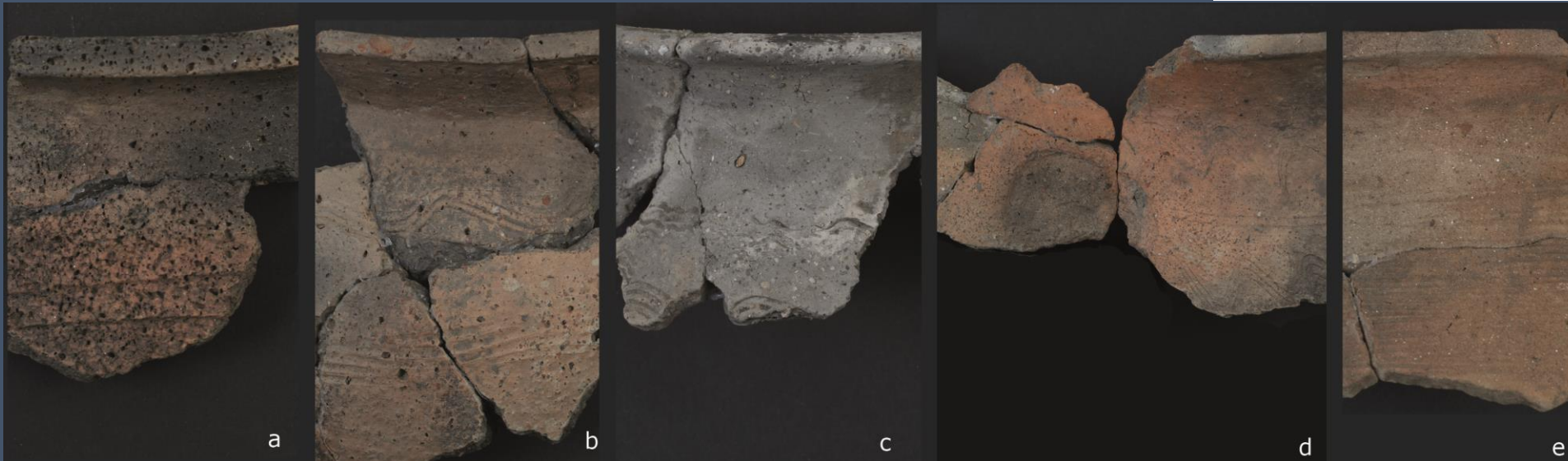
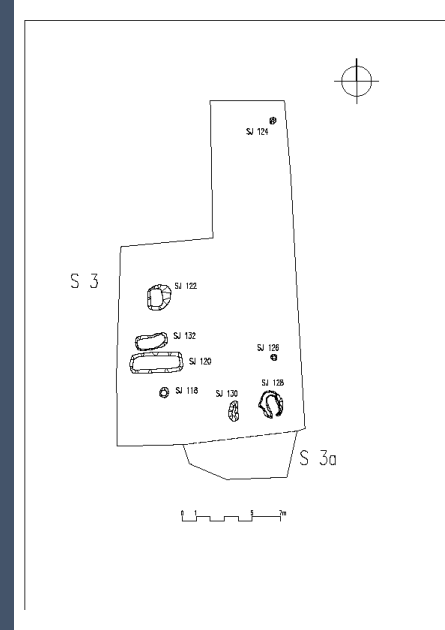

Poriferous

Poriferous with
small pebbles

Clay + pebbles,
rough
structure,
it drops off

Clay + pebbles,
smooth structure

Clay + sand

SU 121
BP 1245±31 Online CalPal Cal AD **760±54**

SU 119
BP 1248±32 Online CalPal Cal AD **756±53**

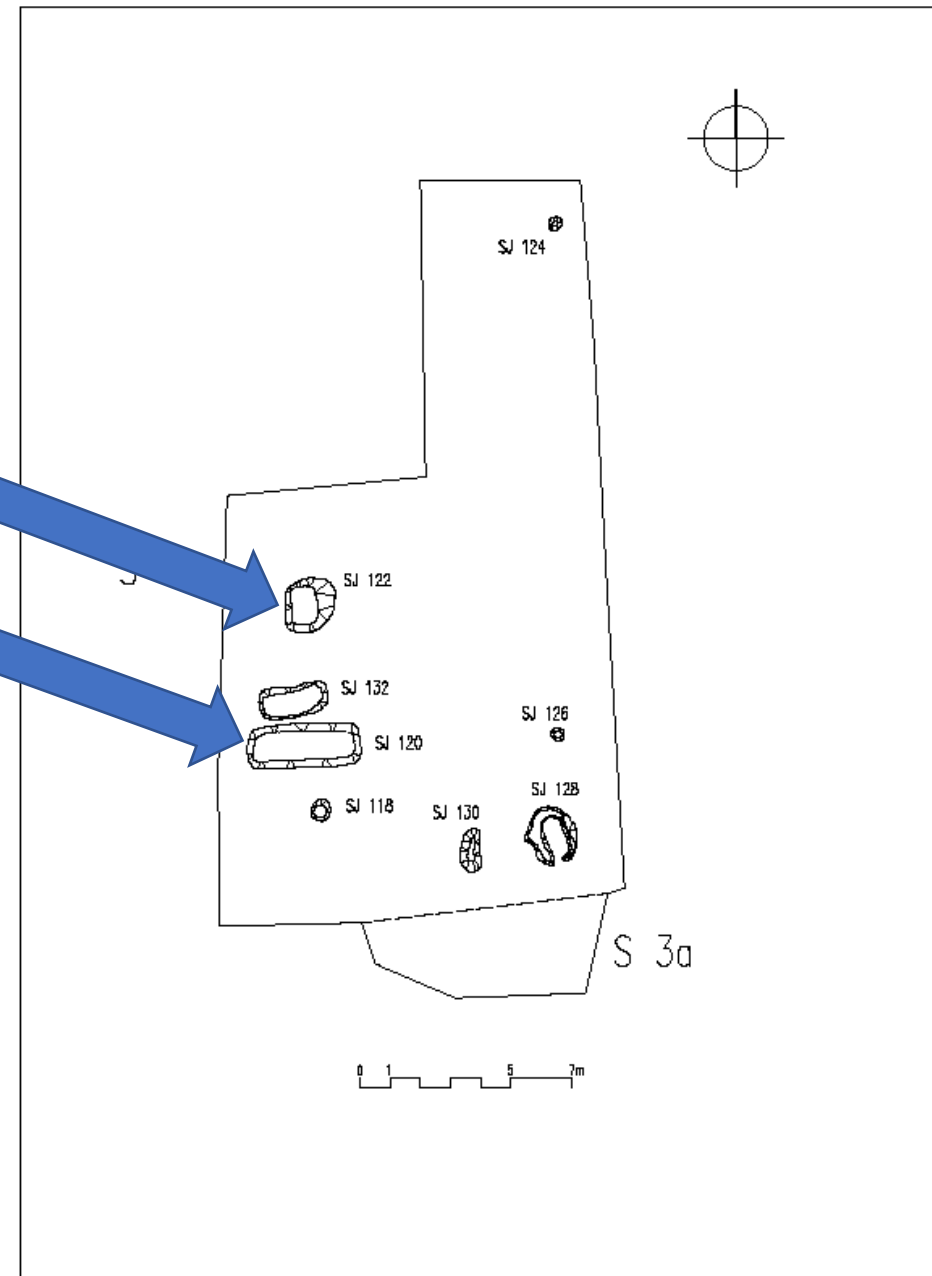
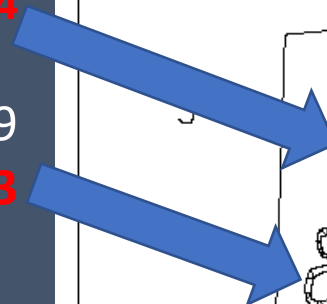

Hlebine – Velike Hlebine
Sekelj Ivančan 2019.

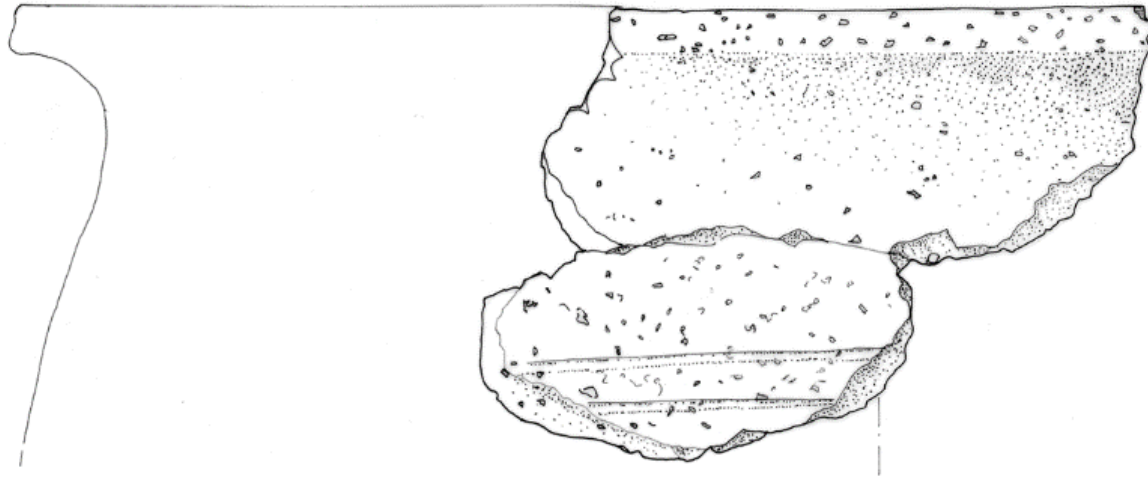

SU 121

Periferous

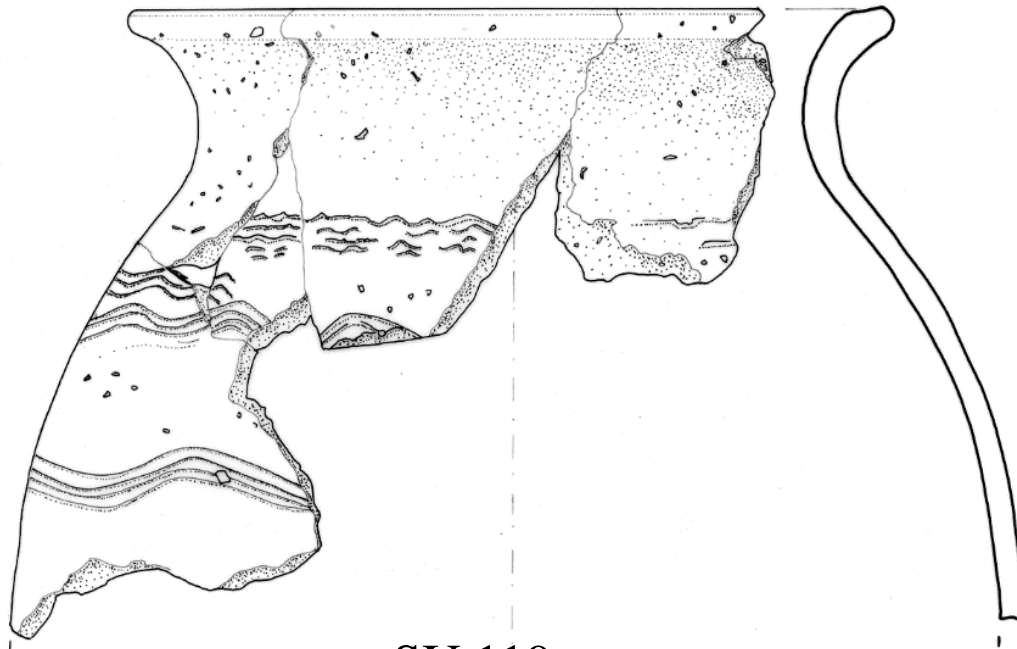

SU 119

Clay + pebbles,
rough
structure,
it drops off

Hlebine –
Velike Hlebine
Sekelj Ivančan 2019.

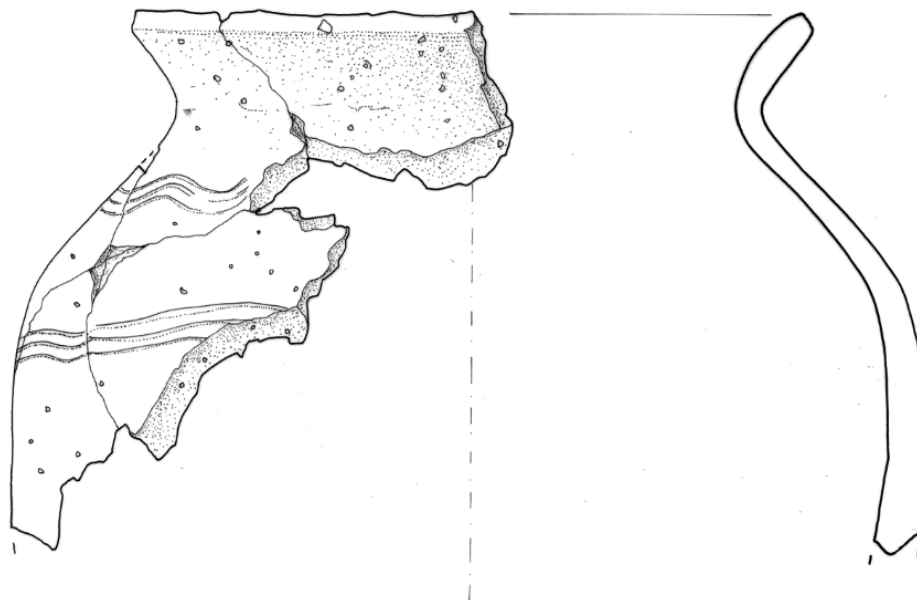

Periferous with small
pebbles

SU 119

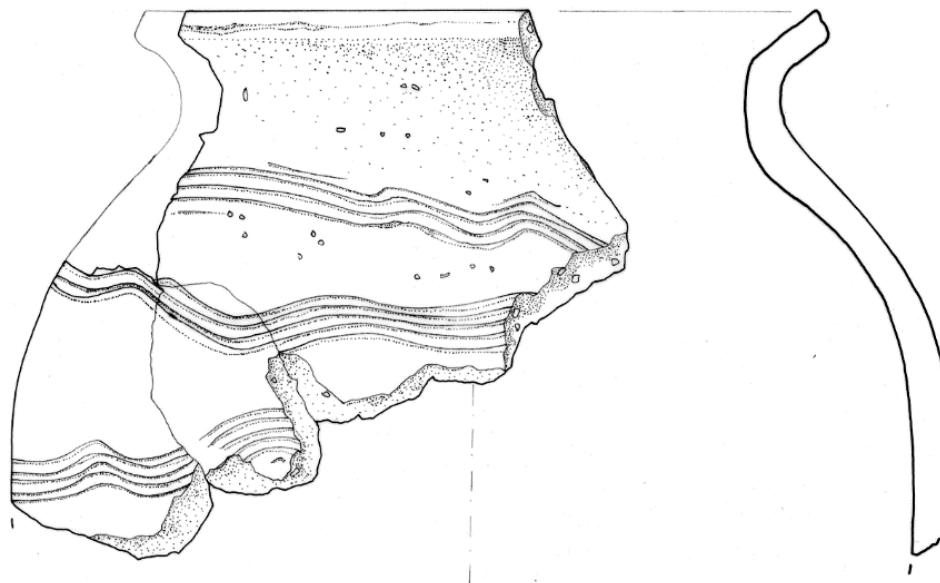

Clay + pebbles,
rough
structure,
it drops off

Hlebine – Dedanovice



Hlebine – Velike Hlebine



Hlebine – Dedanovice



Hlebine – Velike Hlebine



Comparison - Conclusion

Hlebine - Dedanovice

- Datation: middle of 7th century
- 2 types of facture: periferous, small pebbles
- Almost no decoration
- Simple edges (rounded, mildly cutted)
- Straight and slightly uplifted lower surfaces of bottoms, no production/potter marks

Hlebine – Velike Hlebine

- Datation: middle of 8th century
- 4 types of facture: 1) periferous; 2)periferous with small pebbles; 3) clay + pebbles, rough structure; 4) clay + pebbles, smooth structure; periferous in decline
- Decoration present on all examples - same types of decor on different facture types of pottery
- Simple edges (rounded, cutted)
- Straight and slightly uplifted lower surfaces of bottoms, no production/potter marks

Thank you for your
attention!