

Roads and rivers, pots and potters in Pannonia - Interactions, analogies and differences

Schindler Kaudelka, Eleni; Ožanić Roguljić, Ivana; Jelinčić Vučković, Kristina; Miletić Čakširan, Ivana; Andrašić, Izabela; Leleković, Tino; Konestra, Ana; Glavaš, Vedrana; Ugarković, Marina; Berger-Pavić, Izida; ...

Edited book / Urednička knjiga

Publication status / Verzija rada: **Published version / Objavljena verzija rada (izdavačev PDF)**

Publication year / Godina izdavanja: **2022**

Permanent link / Trajna poveznica: <https://urn.nsk.hr/urn:nbn:hr:291:079620>

Rights / Prava: [Attribution-NonCommercial-NoDerivs 3.0 Unported](#) / [Imenovanje-Nekomercijalno-Bez prerada 3.0](#)

Download date / Datum preuzimanja: **2025-04-01**

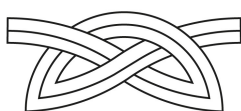

INSTITUT ZA
ARHEOLOGIJU

Repository / Repozitorij:

[RIARH - Repository of the Institute of archaeology](#)



Cijena: 100,00 KN

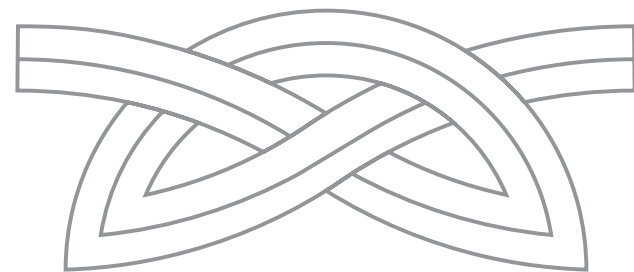

ZBORNIK INSTITUTA
ZA ARHEOLOGIJU

SERTA INSTITUTI
ARCHAEOLOGICI

KNJIGA
VOLUME **17**

ROADS AND RIVERS, POTS AND POTTERS IN PANNONIA.
INTERACTIONS, ANALOGIES AND DIFFERENCES

ROADS AND RIVERS, POTS AND POTTERS IN PANNONIA. INTERACTIONS, ANALOGIES AND DIFFERENCES

Zagreb, 2022.



ZIA
SIA
VOL
17

ISBN 978-953-6064-59-5



9 789536 064595 >

ROADS AND RIVERS, POTS AND POTTERS IN PANNONIA - INTERACTIONS, ANALOGIES AND DIFFERENCES

Zagreb, 2022



ZBORNİK INSTITUTA ZA ARHEOLOGIJU
SERTA INSTITUTI ARCHAEOLOGICI
KNJIGA / VOLUME XVII

IZDAVAČ / PUBLISHER

Institut za arheologiju, Jurjevska ulica 15, 10000 Zagreb

ZA IZDAVAČA / FOR THE PUBLISHER

Marko Dizdar

UREDNICI / EDITORS

Ivana Ožanić Roguljić, Angelina Raičković Savić

IZVRŠNI UREDNICI / DESK EDITORS

Ivana Ožanić Roguljić, Angelina Raičković Savić

RECENZENTI / REVIEWERS

Robert Matijašić, Snežana Golubović

ZNANSTVENI IZDAVAČKI SAVIJET / SCIENTIFIC EDITORIAL BOARD

Igor Borzić, Valentina Mantovani, Martin Auer, Paul Arthur, Hrvoje Kalafatić

PRIJEVOD / TRANSLATION

Authors

KOREKTURA / PROOFREADING

Ivana Ožanić Roguljić, Angelina Raičković Savić

OBLIKOVANJE I RAČUNALNI SLOG / DESIGN AND LAYOUT

Hrvoje Jambreč

OBLIKOVANJE NASLOVNICE / COVER DESIGN

Roberta Bratović, OAZA

AUTOR FOTOGRAFIJE S NASLOVNICE / COVER PHOTO

Ivana Ožanić Roguljić, keramički material s lokaliteta Osječenica Gorička

TISAK / PRINTED BY

HŽ Putnički prijevoz d.o.o., Strojarska cesta 11, Zagreb

CIRCULATION

100 kom

©Institut za arheologiju u Zagrebu. Sva prava pridržana.

©Institute of Archaeology Zagreb. All rights reserved.

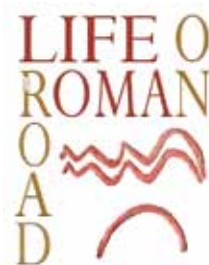

CIP zapis dostupan u računalnom katalogu Nacionalne i sveučilišne knjižnice u Zagrebu pod brojem 001140356

A CIP catalogue record for this book is available in the Online Catalogue of the National and University Library in Zagreb as 001140356

ISBN 978-953-6064-59-5

The publication results from the project LIFE ON THE ROMAN ROAD: communications, trade and identities on Roman roads in Croatia from 1st – 8th CE, UIP-05-2017-9768, supported by Croatian Science Foundation.

Contents

PREFACE	4
ELENI SCHINDLER KAUDELKA Pannonische Glanztonware. A Special case in Central Europe or just a general pattern in Roman Pottery?	5
IVANA OŽANIĆ ROGULJIĆ, KRISTINA JELINČIĆ VUČKOVIĆ Introduction to Pannonian slipped ware in Croatia	31
IVANA MILETIĆ ČAKŠIRAN Pannonian slipped ware from Sisak	57
IZABELA ANDRAŠIĆ Pottery with VERUS RE stamp from Sveti Martin na Muri	67
TINO LELEKOVIĆ Pannonian slipped ware from Mursa: View of current level of research	75
ANA KONESTRA, VEDRANA GLAVAŠ, MARINA UGARKOVIĆ Goods from the North. An update on wares, shapes and occurrences of Pannonian and other continental fine wares in the province of Dalmatia	99
IZIDA BERGER-PAVIĆ Pannonische Glanztonware im Nordwesten Pannoniens – Carnuntum und Vindobona, mit einer Auswertung der Ware in der Provinz und im Allgemeinen	113
JURE KRAJŠEK, TINA ŽERJAL Celeian slipped ware. Pannonian slipped ware (PSW) from Celeia: the evidence from Mariborska cesta excavation	159
MAJA JANEŽIČ, ELENI SCHINDLER KAUDELKA Fine tableware of Poetovio production: a short summary	171
JASMINA DAVIDOVIĆ Pannonian slipped ware in Sirmium	183
ANGELINA RAIČKOVIĆ SAVIĆ Pottery from Viminacium - a craft product of multipurpose function	199
ALEXANDRA NAGY Stamped pottery in Aquincum	209

Preface

There are many names in Croatian, German and English for class of pottery discussed in this volume.

Generally accepted terms are:

- Panonska keramika s premazom (PKP)
- Pannonische Glanztonware (PGW)
- Pannonian slipped ware (PSW)

The PKP, PGW or PSW is a group of pottery widespread in *Pannonia*, but also in *Noricum* and *Moesia*, from the end of the 1st well into the 3rd century A.D and even later. The shapes of the vessels recall the forms of the Terra Sigillata, but some of them also show the influence of the local utility ware. The appearance of this group can be described as high-quality pottery with a slip. It was produced in a reduced, oxidant and mixed atmosphere: as a result, there are black, grey, red, and orange vessels.

In this book, authors were allowed to follow their thoughts and intuition to create the information about the Pannonian slipped ware in the region they work. The lack of publications, especially in Croatia, was the main problem in developing more uniform descriptions of types and features that form the PSW. We hope to create a fixed point from which a more comprehensive study can be made.

We are grateful to all colleagues who submitted an article for this publication. This way, we have gathered some of the current knowledge on this topic, and we hope to continue our cooperation. We can say that this publication is a work of a small study group dedicated to one topic.

In the meantime, by May 13, 2022, an important article about Pannonische Glanztonware that was published on the website of Römisch-Germanisches Zentralmuseum, Mainz (RGZM) "disappeared" from the Internet. RGZM is developing a new modern website. Hopefully, the paper will appear again on the new RGZM site.

A possible new link is: <https://web.rgzm.de/forschung/forschungsinfrastrukturen/infrastrukturen/wissenschaftliche-it-digitale-plattformen-und-tools/online-datenbanken/>

Editors

PANNONISCHE GLANZTONWARE.

A SPECIAL CASE IN CENTRAL EUROPE OR JUST A GENERAL PATTERN IN ROMAN POTTERY?

Wherever the Romans arrived, they found a pottery craft sufficient to satisfy the needs of the local population. Romans settled with their food habits. Therefore, their luggage contained tableware and a number of necessary kitchen tools. Moreover, Roman craftsmen are among the first to move and open a workshop in a newly conquered territory. Regional potters swiftly integrated the Roman fashion into their production while maintaining their time-tested techniques. Shapes added to the regional repertoire rather than supplanting it were kept simple and adapted to local conditions and primary sources. Already a generation later potters both local and immigrated collaborated to create a common culture of the everyday when a new set of shapes that used single elements considered autochthone expanded the repertoire. This is not a singular phenomenon, but a sound sign of lifestyle in the now Roman world. The mechanism is the same in all Roman provinces from today's Spain to Romania, from Britain to Greece and Turkey, but the character of plates, bowls, beakers and pitchers is different according to the regional needs and traditions.

Key words: Pannonian Slipped Wares, Regional Table Ware production, Workshops with mixed repertoire



Fig. 1 Pannonische Glanztonware in its beauty, (Collage ESK)

It is not more than 20 years since *Pannonische Glanztonware*, more recently abbreviated to PGW, became the established denomination of these beautiful Roman tablewares. A wide range of names has been in use since they were first recognized, and the panorama is far from unitary. PGW remains a heterogeneous group discussed among scholars. The general approach to classifications in pottery studies emphasizes small differences rather than search common characteristics and similarities. For *Pannonia*, the general introduction of the Römisch-Germanisches Zentralmuseum, undated but roughly 20 years old, is still valid in most ways. (<https://www2.rgzm.de/Transformation/Magyarorszag/Glanztonware/GlanztonwareEnglisch.htm>). Consulted January 21st 2021

Classifications are not a goal but a work tool and a procedure document. In order to be considered as a historical source of prime importance and be noticed by ancient historians, ceramologic studies need to be synoptic and comprehensive. Therefore, it is necessary to offer reflections beyond mere typochronology.

Despite the focus on difference to classify find groups in archaeology, some seminal considerations are in order. They generally reveal a couple of mechanisms beyond classification and chronology visible all over the Roman Empire, in particular, the part north of the Mediterranean. The present considerations do not attempt to synthesise but are intended as a reminder not to get lost in details just for the pleasure and lose a more global approach in this manner.

BRIEF HISTORY OF RESEARCH

The view from Noricum as it emerges in August Schörgendorfer's book (Schörgendorfer 1942) is clear and distinct. Except for a couple of early Magdalensberg cups and some Tardopadana shapes he called "Gefälschte Sigillata", he did not bother with the topic of locally made international shapes. This was to expect because he dealt with regional and local wares, and he was aware that PGW was imported to Noricum. More than 60 years later, Christian Gugl and Roman Sauer investigated a possible local production of Glanztonware from the Wohnterrassen in Teurnia (Gugl-Sauer 1998). The results were deceiving. Up to now, almost 80 years after Schörgendorfer, there is no proof of production in Noricum.

PGW was popular tableware in *Noricum*, but despite the lack of similar local productions, finds do not cover the whole territory. South of the Alps distribution reached *Aguntum* in the West of the province, while along the Limes, no finds are recorded west of *Lauriacum*.

First studies in *Pannonia* mostly centred around the production of a single potter started in the 1860ies. As early as 1884, Bálint Kuzinskzy recognized PGW as a regionally made products. Joseph Déchelette (Déchelette 1904: 333) gave the stamped wares some thought, but Eva Baranyai Bonis was the one who brought the curtain up for *Pannonische Glanztonware* (Bonis 1942). She recognized the pattern behind the potter's names or the decorations. Since she was required to set together shapes and presences the same way as Schörgendorfer did in Noricum, her emphasis was on heritage, influence from abroad, transitional style and local innovation with its implications to the repertoire. This is how she concludes, p. 56. „Die Resultate unserer Betrachtungen sind die folgenden: ... Durch den Einfluss der römischen Technik entstand aus der Gefäßkunst der keltischen Töpfer eine sonderbare, die Stilzeichen einer Übergangszeit tragende Keramik. ... hier ist schon der Einfluss der westlichen keltisch-römischen (belgischen) Formen merklich ... Die dritte Quelle der keltischen Elemente ist das Keltentum Oberitaliens“.

Translation: Under the influence of Roman know-how, craft and imagination of the Celtic potters created curious pottery carrying the stylistic features of the changing times. The influence of western Belgic shapes is perceptible. The third source of from the North Italian Celtic community.

This shows that already 80 years ago, scholars had a fair notion of the evolution and the impact of the Romans in local crafts. Schörgendorfer and Bonis are not the only ones. Every now and then, one should have a look at books published more than ten years ago.

Forty years ago, Olga Brukner took a more traditional approach. Dealing with classification, chronology and distribution of imports and native pottery, she was mainly interested in the survival of autochthonous traditions compared to imported goods. PGW are called imitations of terra sigillata and terra nigra. She divides into two main craft sources. (Brukner 1981: 186-189).

After the discoveries made from the 1980ies onwards, the view on production centres changed and shifted. Aside from presuming only specialized workshops to be active in long and medium distance trade, polyvalent ateliers are of high importance for the economy all over the provinces of the Roman Empire.

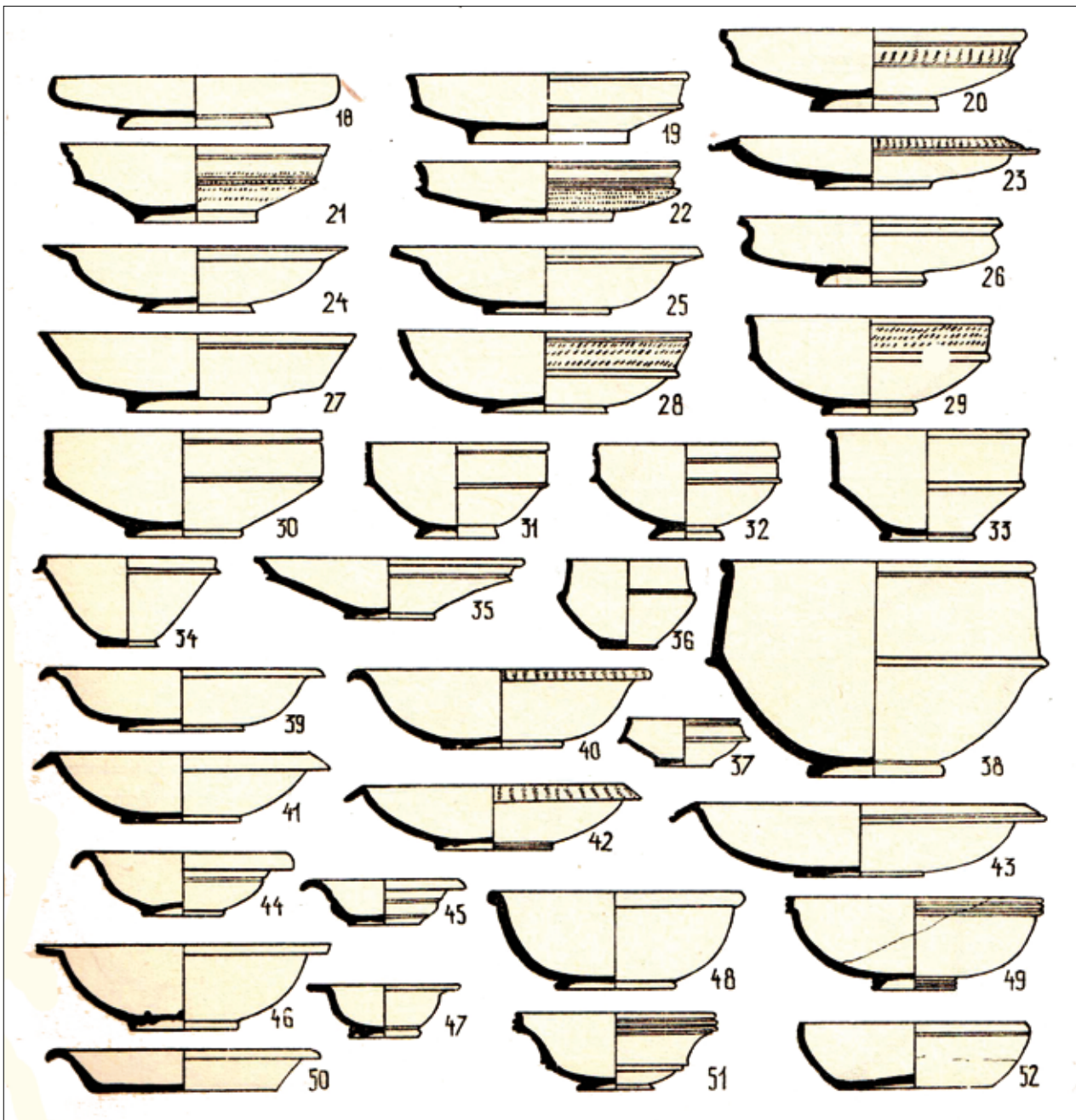

Fig. 2 Pannonische Glanztonware (Bonis 1942, Tafel 21)

The current state of the question in the Roman economy favours multi-layered organization and leaves aside the approach of the primitivists. Production and trade explanatory models point to different types and sizes of business. The prospect includes highly specialized mass production centres with extensive trade connections organized in big factories and grouped craft centres. They were supplemented by a wide range of polyvalent ateliers in different sizes, whose products were distributed through regional trade. Small workshops produced mainly for local consumers and the manufactures only occasionally reached a wider market. Household business and subsistence economy persisted over the times (Auer 2014).

Depending on the researcher's view, the question "do ceramics know no boundaries?" can be either enthusiastically affirmed or sourly denied, but a more fact-based approach is in order since better evaluation can be achieved.

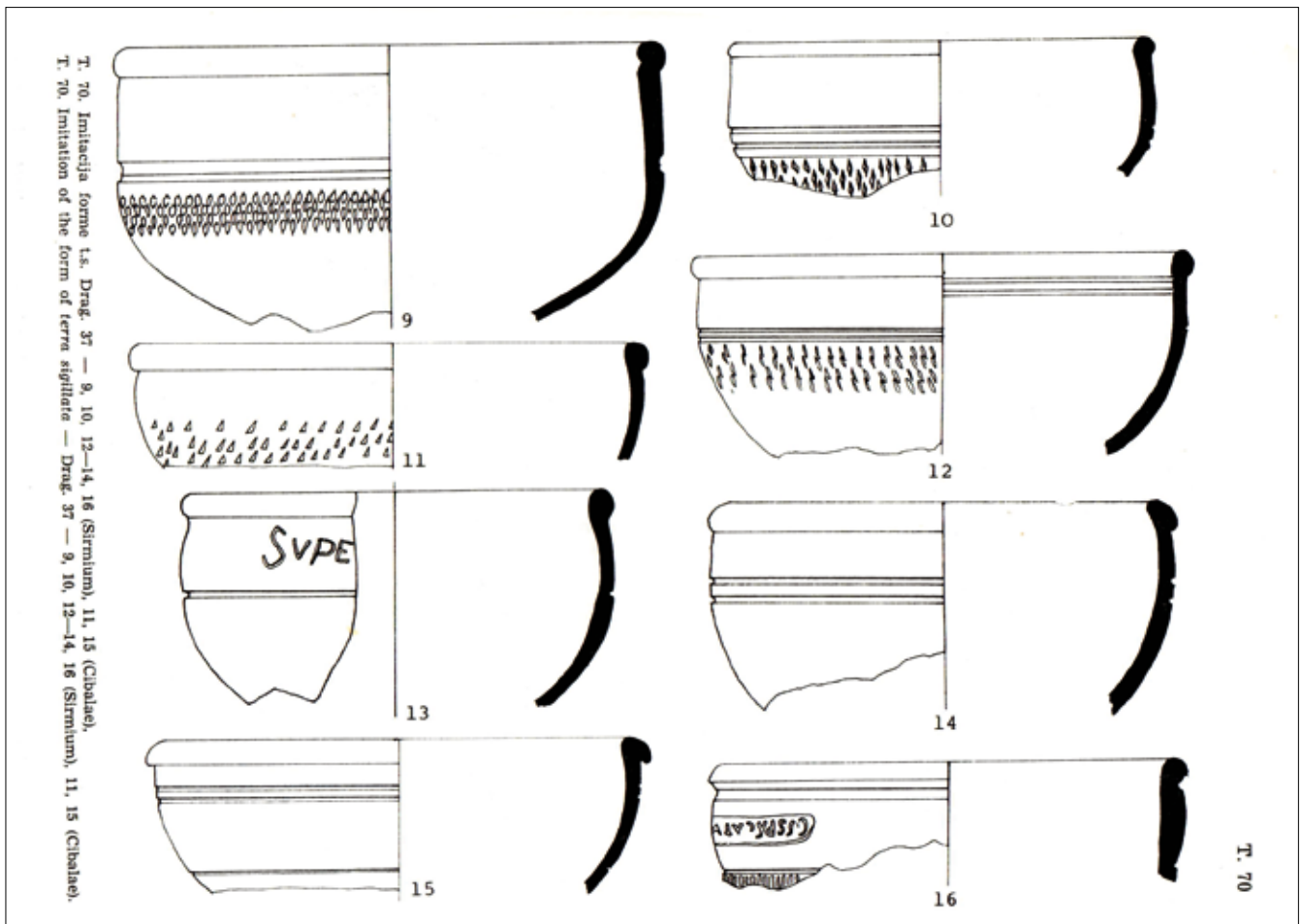

Fig. 3 Pannonische Glanztonware (Bukner 1981, Pl. 70)

OUT AND ABOUT

Pottery groups similar to *Pannonische Glanztonware*, comparable in technology, repertoire and diffusion, are present all over the Roman world. They come under different names, and therefore they are sometimes enigmatic to spot in the bibliography. Through an open but by no means exhaustive selection, it is possible to trace the line of different regional productions fashioned on a similar pattern.

At this point, I would like to thank all friends in my network who graciously shared their general knowledge and their personal view of the regional wares. This enabled me afterwards to peruse the bibliography of the *Fautores* successfully.

THE IBERIAN PENINSULA

The production of pottery comparable to PGW in *Hispania* and *Lusitania* started immediately after the conquest, at the beginning of the second century BC (*Ceramicas Hispanorromanas. Un estado de la Cuestion, Bloque 2, Roma en la fase de conquista Siglos III-I S.AC* and *Bloque 3, Nuevos Tempos, Nuevos gustos, Augusto-siglo II*). The earliest copies of imported wares made in the local workshops are black slipped wares, regionally made *Campana*. It is obvious that the shapes were adapted from travelling pots brought by Romans.

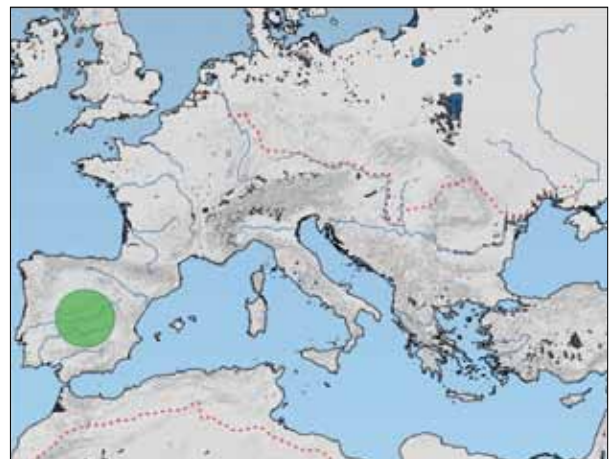

Map 1 Iberian Peninsula (C. Ardis)

The pottery comes under different names, the generic ones being *Ceramica Celtiberica* and *Ceramica de tradición punica*. According to the region where they were found and in all probability manufactured, archaeologists named the cups and plates *Ceramica Ampuritana*, *Gruppo Illuro or Ilesso*, *Engobada de Illerda*, *Imitaciones Val del'Ebro* and *Pseudocampaniense ebusitana*.

All are well studied and easy to reach in pottery guidebooks. They were first made in what Maurice Picon defined as *cuisson en mode A*, either in open bonfires or in direct flame kilns. The latter appear scattered all over the Peninsula.

With a step away from the black slipped campanoid cups, bowls and dishes to the red *Ceramica tipo Penaflor*, Spain adopts the tradition of *Sigillata* making quite early. Firing techniques in kilns with direct flames are traditional. Shapes are kept simple and remain pretty close to the Roman antetypes. Spain is in a happy situation to have large and well-studied evidence of ceramic workshops. Except for those located in the immediate vicinity of agricultural sites linked to the Roman food industry specializing in amphorae production, all others seem *multirepertoire ateliers* (Morillo 2008: 113-125).

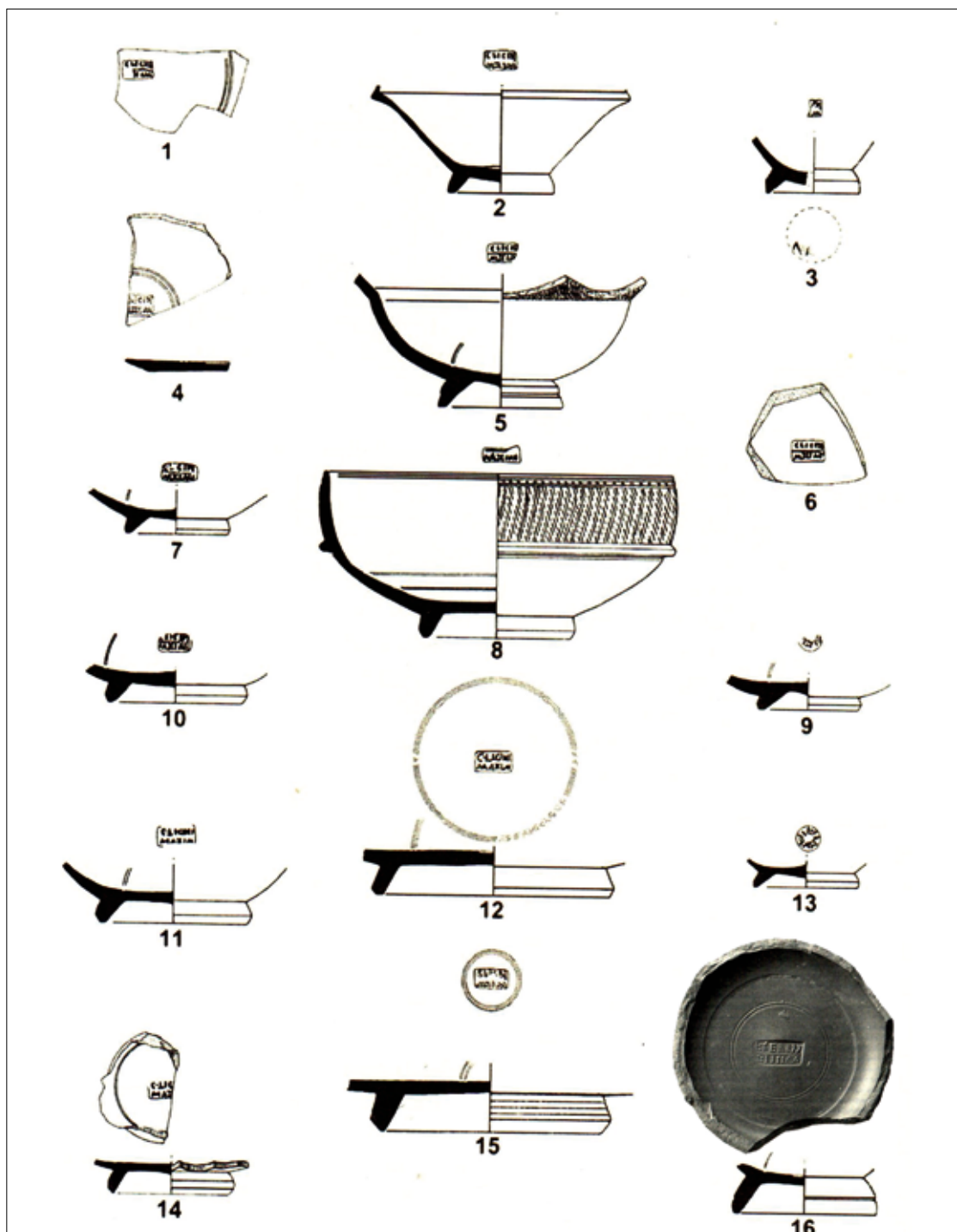

Fig. 4 *Ceramicas Hispanorromanas Legio Macedonica C. Licinius Maximus* Collage (after Morillo 2008, fig. 3 and fig. 4

In Hispania, the tradition of migrating potters can be followed from the beginning with the craftsmen enrolled in the Legions. C. Licinius Maximus and L. Terentius of the Legio Quarta Macedonica took close inspiration of Italic sigillata shapes and stamped alternately with their or their legions name. It can be assumed this widespread phenomenon was known in Central Europe also, although we still lack confirmation.

Iva Mikl Curk realized that the beginning of Roman-style production in the local workshops of Poetovio utterly coincides with the arrival of the Legio XIII from Vindonissa in Claudian times as shown by the earliest shapes Consp. 20.4 and Consp. 34.

Spain also has a considerable amount of what some people still call “real sigillata” workshops in contrast to “imitation”. This distinction should be obsolete since 1990, when Colin Wells asked “Can a man imitate himself?” in his fundamental pages on the topic (*Conspectus* p. 25). However, we still read imitations or “forged sigillata” every now and then.

From the second century onward, the production of sigillata with relief decoration was common all over the Iberian Peninsula. The firing took place not always in kilns like the big one in La Graufesenque, sometimes it was done with a technique borrowed from hypocaust heating.



Fig. 5 Ceramics Hispanorromanas Sigillata Hispanica (after Fernandez-Garcia, Roca Roumens 2008, Fig. 9)

There is just the long-distance trade part of the generally assigned definition missing. Plain shapes were produced as early as in Claudian times. At the same time, relief wares are known from the third quarter of the first century, with decorations first influenced from those common in southern Gaul before getting their flourish and independent way over the second century. Aside from travelling now and then across the Pyrénées it generally remains in the Iberic Peninsula, but some of it has been recognized in Africa. (Fernandez, Roumens 2008: 307-332).

GALLIA BELGICA

In 1895 Constantin Koenen was already interested in an assemblage from the graveyard of Andernach, which he characterized as neither Roman nor Celtic. Right in the same year Hans Dragendorff created the term *Belgische Ware* for "... céramique fine, regroupant des imitations de terre sigillée italique d'une part et des formes et des décors d'inspiration celtique d'autre part..." (Deru 1996: 15). Translation: fine ceramics, combining imitations of earthenware signed italic on the one hand and forms and decorations of Celtic inspiration on the other hand.

The classic reference book is the PhD of Xavier Deru. His main topic is terra nigra, but all his results apply to terra rubra as well. Both are typical for the medley of Celtic shapes with the new tableware made in the Mediterranean way. Native potters prepared clay to appear in silky and slightly soapy texture and applied a surface treatment varying from none to burnishing, from dipping to brushing and polishing, to cover the complete vessel or only parts of it. Decorations are incised or excised, stamping occurs frequently, and barbotine in simple dots or lines is common. Potters avoid complex patterns and decorate surfaces with rough sanded stripes. They take up from both Italy and Celtic decorative traditions and create something completely new. Potters stamps applied in Mediterranean habitude in radial, as well as central position, refer only to natives. Letters and pseudo-letters are present mostly in rectangular or circular frames. *Planta pedis* remains rare because of the early dating.



Map 2 Gallia Belgica (C. Ardis)

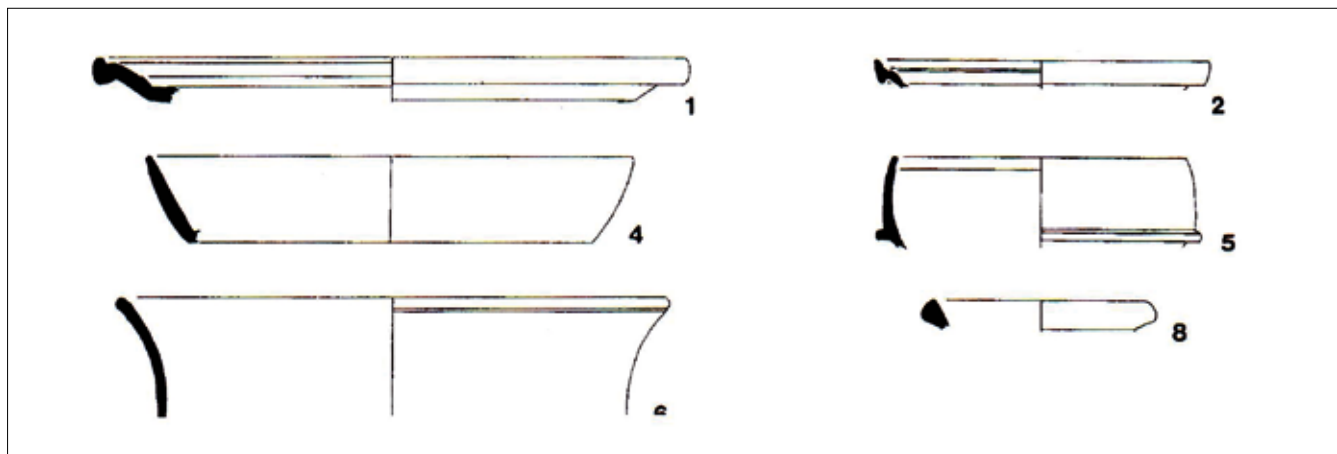

Fig. 6 Belgische Ware Chronologie Horizont 1 St. Martin Langeau (after X. Deru Fig. 196)

Deru not only classified his material and attributed it to workshops. He also established an eight horizon sequence based on well-dated sites. Belgian pottery is a sound chronological marker.

He did not get lost in the typo-chronological assessment. In addition to examining stylistic differences in the regional workshop groups, the book also offers conclusions on economic, cultural, historical and social matters.

For a long time, French archaeologists working in the South, this is Cesar's Aquitania, avoided the name for a very similar type of pottery, both in grey or red, always in very soapy clays fired in Picon's mode A. Lately, they speak of Southern Belgian wares. Denominations are not always logical.

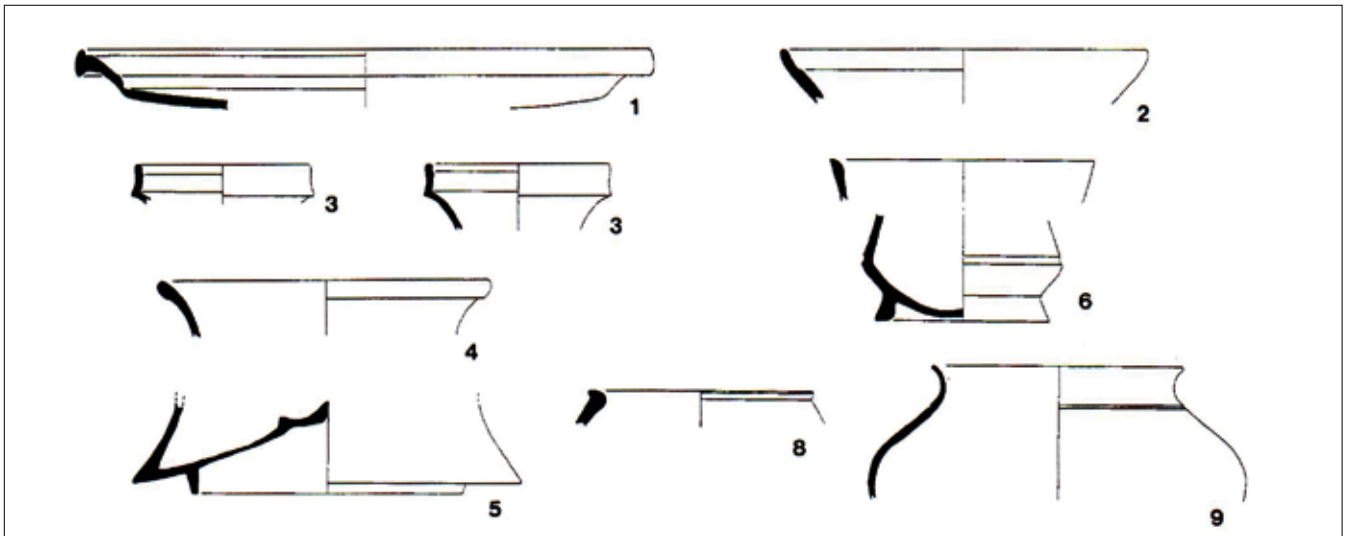

Fig. 7 Belgische Ware Chronologie Horizont 2 St. Martin Langeau (after Deru 1996, Fig. 195)

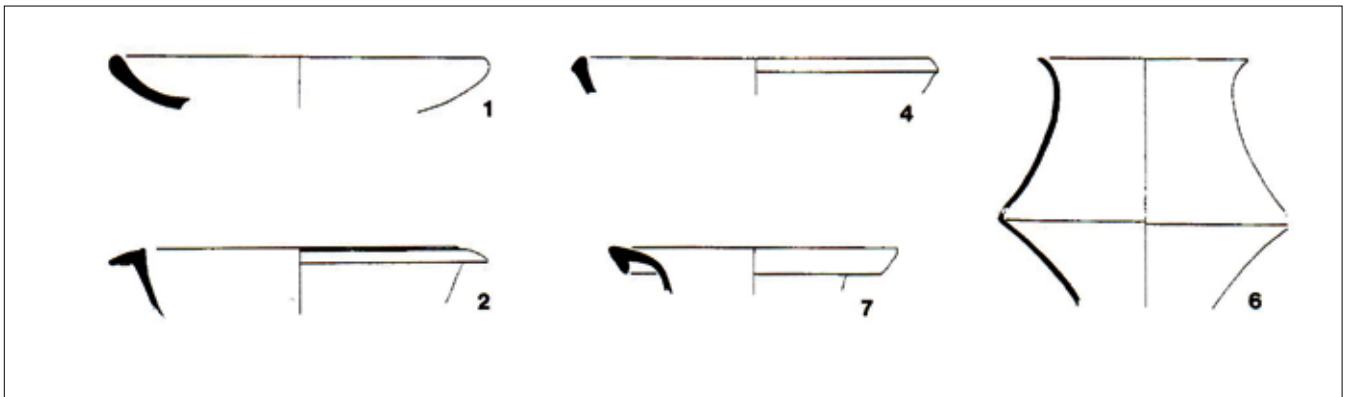

Fig. 8 Belgische Ware Chronologie Horizont 3 St. Martin Langeau (after Deru 1996, Fig. 197)

After this brief and compact assessment, it is important to mention abundant French studies on Gallo-Belgian pottery. The proceedings of the SFECAG conference held 2018 in Reims contain the most recent information on the topic.

GERMANIA

Celtic and Roman features side by side characterize the Lagerkeramik, as Siegfried Loeschcke named it. Some of it was manufactured in the legionary pottery workshops, but civil potters offered the same merchandise. The repertoire is not restricted to the Roman shapes, where it loosely follows the fashion created by Italian Sigillata, regardless of the strict provenience from Arezzo, Pisa or Lyon. Potters seem to avoid high feet, perhaps because the clay was too plastic and prone to collapsing.



Map 3 Germania (C. Ardis)

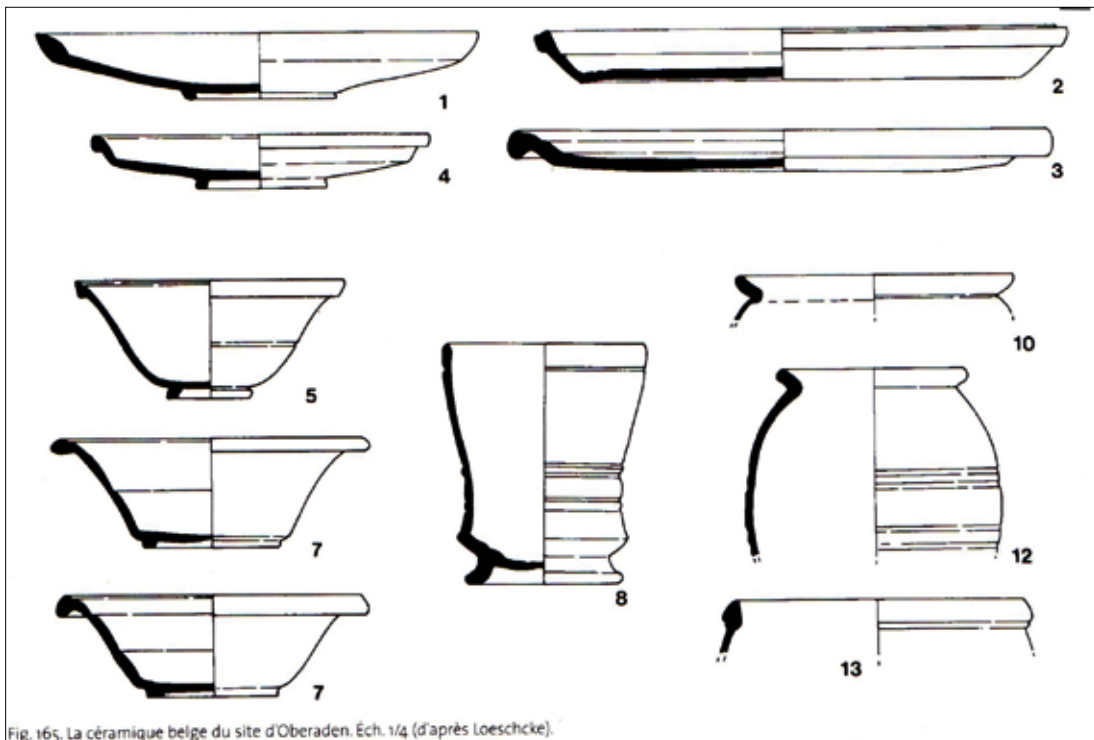

Fig. 165. La céramique belge du site d'Oberaden. Éch. 1/4 (d'après Loeschcke).

Fig. 9 Legionskeramik Oberaden (after Deru 1996, Fig. 165)

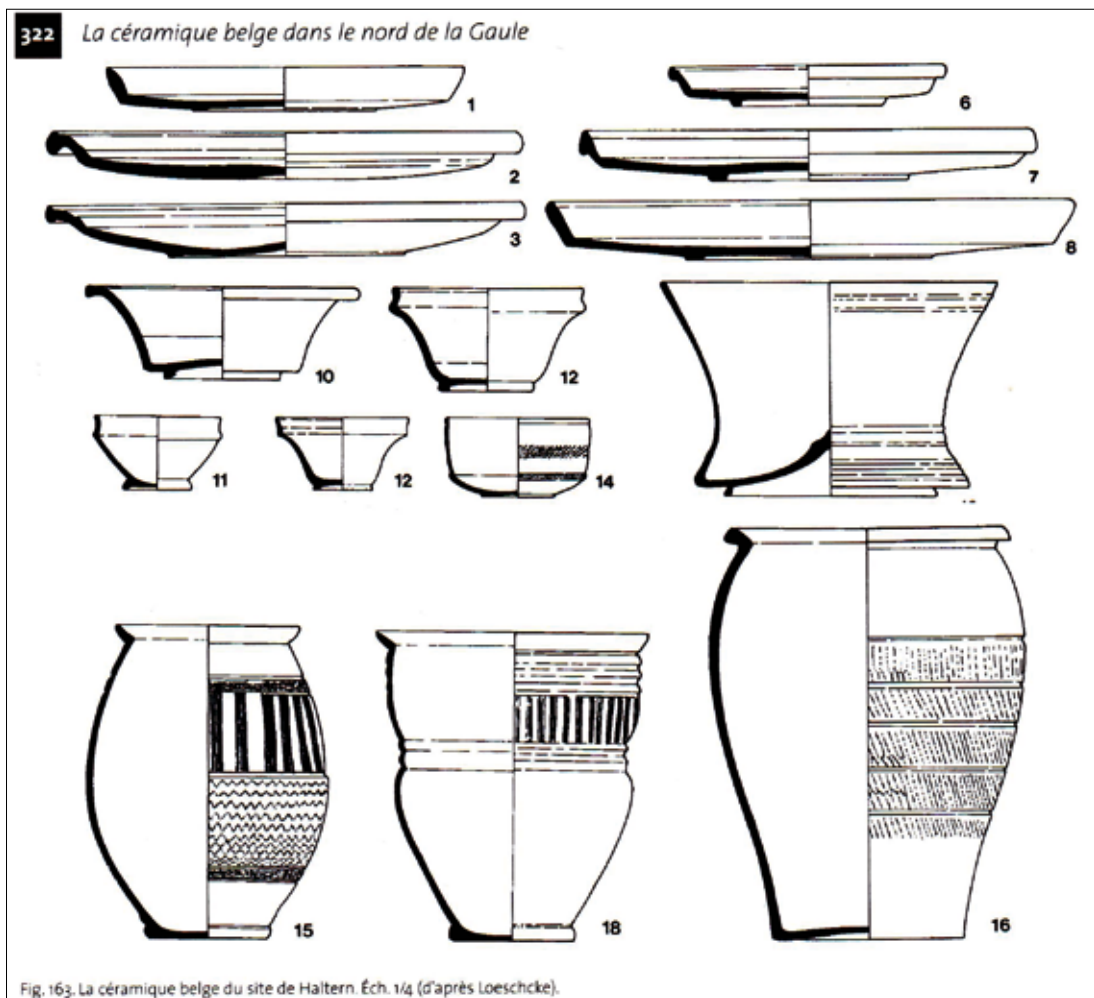

Fig. 163. La céramique belge du site de Haltern. Éch. 1/4 (d'après Loeschcke).

Fig. 10 Legionskeramik Haltern (after Deru 1996, Fig. 163)

Cups, bowls and plates in Service 1 and 2, partly stamped and compatible with the Belgian Wares produced in the Champagne, are made in the same silky feeling clays and come along with native shapes, conical and bellied beakers in the tradition of bols de Roanne and vases à bobbine and assorted pots complemented by deep sometimes crenated dishes. The pottery excavated by Emil Ritterling in the Claudian military camp Hofheim already boasts with a notable presence of neo-Celtic details.

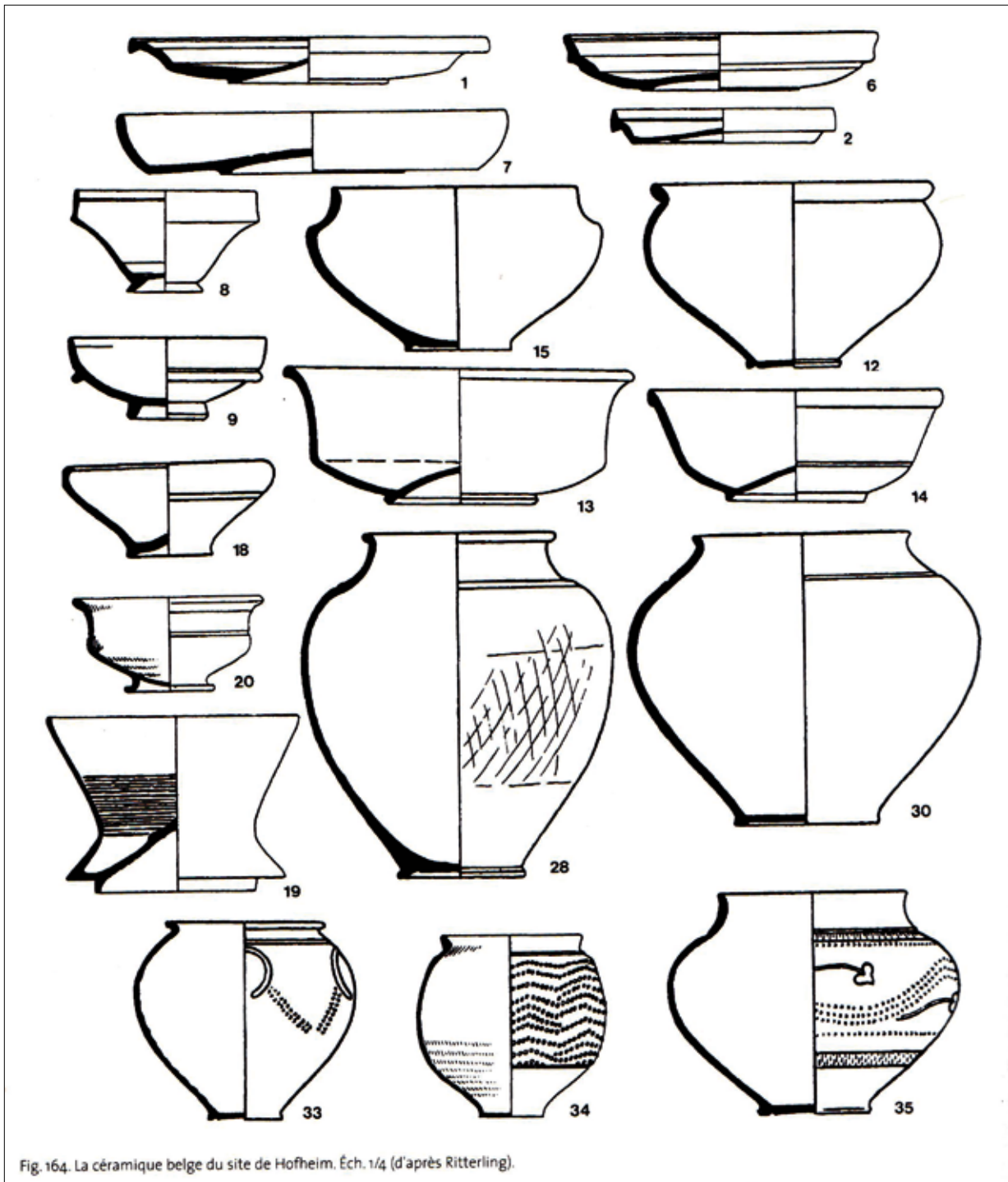

Fig. 164. La céramique belge du site de Hofheim. Éch. 1/4 (d'après Ritterling).

Fig. 11 Legionskeramik Hofheim (after Deru 1996, Fig. 164)

These are missing in the finds from the older camp of Oberaden, where the repertoire of the Belgische Ware remains still in the duplicity of Roman and native Celtic shapes.

In Haltern, the change in typology towards newly created shapes of the third typological branch with single Celtic elements is yet barely visible.

Germania features another completely different highlight that helps to understand some of the mechanisms. Wetterau Ware represents a much later dinnerware with a typical profile and regional success. The definition goes back to Karl Bettermann at the end of the 19th century, while the scientific impact remains closely connected with Vera Rupp and Susanne Biegert. Although once again fired in Piconis quite en mode A technique and distributed only regionally, it nevertheless is a kind of Sigillata with its particular character. Often compared to most marbled fabrics, it covers a much more extensive range of shapes and a large variety of high-quality decorations, some in pinkish-white painted patterns and others in brushed sponge surface. The thick red slip sometimes comes in purposely changing shades of red from coral to brownish orange. Wetterau ware was not limited to pure tableware because the potters also produced lamps, cult vessels, jugs and bottles, colanders and funnels.



Fig. 12 Wetterauer Ware in the Saalburgmuseum (wikiwand free use permitted November 23rd 2020)

Dating range is all over the first century until around 150 AD. It is worth noticing that the production ran out when the first potters in the large Sigillata manufactures in Rheinabern started their huge production that flooded the Northern Roman empire for over a century

BRITANNIA

The Roman province of Britain is a very different ceramic world as for shapes and fabrics in pottery. State of the art is excellent and easy to navigate due to up-to-date online resources. For the present topic, potsherd.net provides complete information.

After controlling the keyword Gallo-Belgic terra nigra it can be confirmed that in the utmost northwest of the Empire, the phenomenon is somehow different to down south and back east. Belgic *terra nigra* and *terra rubra* were imported from Gaul. For terra rubra, Paul Tyers made two important observations. Presence can be dated earlier, while it seems not to have been locally copied. A drop in numbers is noted in Augustan-Tiberian times, perhaps a reason for the emergence of a British *terra nigra* still quite anonymous.



Map 4 Britannia (C. Ardis)

Local production seems to start only with the creation of the province in Claudian times, but the taste for things Roman-style dates earlier.

A discussion with Kevin Greene generated the following answer: "We don't get any serious imitation of TS in Britain apart from some small production by potters from central and eastern Gaul near London and in Colchester as you undoubtedly know". He calls imitation locally made tablewares adapted from international fashion and makes a difference between local workshops and ateliers implemented by potters who arrived from abroad.

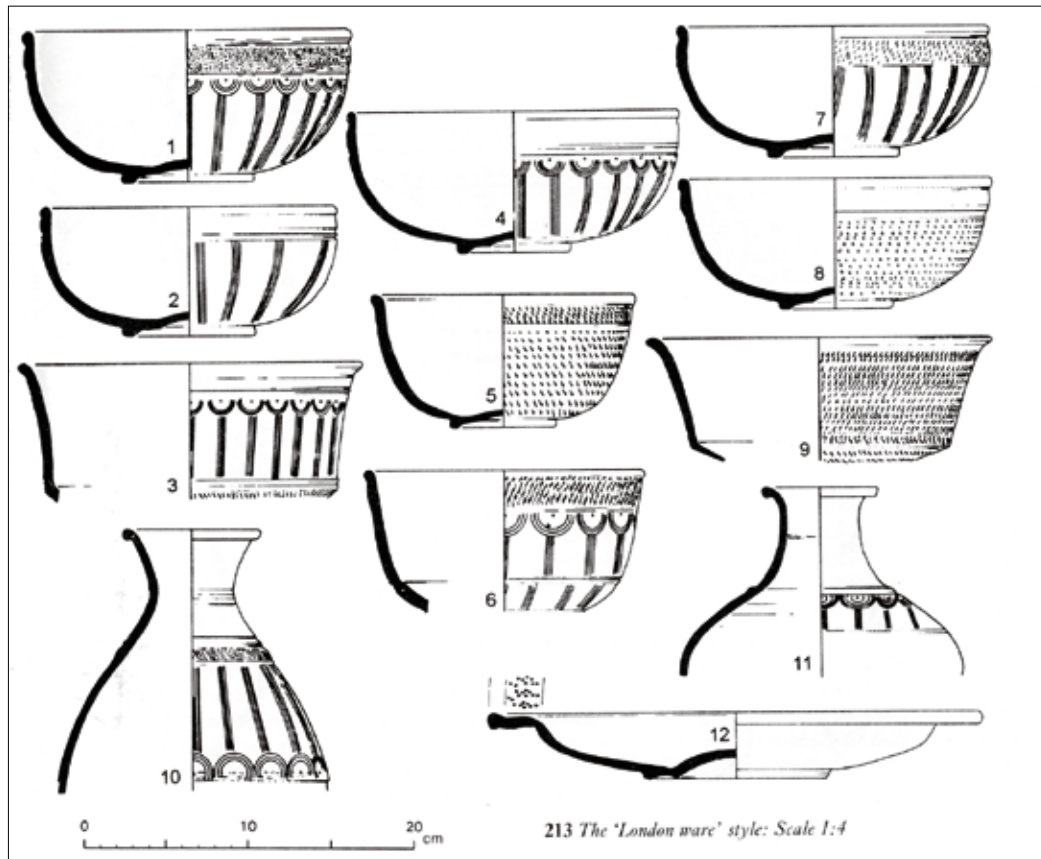

Fig. 13 London ware (after Tyers 1966: Fig. 213)

In Britain, the term *terra sigillata* or Samian applies to not only cups and bowls, jugs and bottles and plates distributed on a small range. The potters G.SE, Verian and Acapa are known from a south English production dated in the second quarter of the second century mainly based on "The elements employed on the decorated bowls are 'borrowed' from vessels made by potters working at Les Martres-de-Veyre and Lezoux (Central Gaul), probably by copying from finished bowls" (Tyers 1996: 105).

The production of Colchester Sigillata is dated slightly later and covers the second half of the second Century. Potters from Sinzig and Trier, perhaps also from La Madeleine moved or were sent to *Camulodunum*, where they set up a production typologically fitting the East Gaulish role models. Without chemical analysis, it is impossible to attribute vessels to one or the other group. The main potters of Colchester Sigillata are *Acceptus*, *Amandinus*, *Conopectus*, *Gabrus* and *Littera*. They sign with names both Roman and neo-Celtic.

A very similar development with the setup of regional Sigillata workshops done by migrated potters can be observed in Central Europe during the second half of the second Century. Whether this happened because transports were less safe than before or if this is due to other reasons remains an open question.

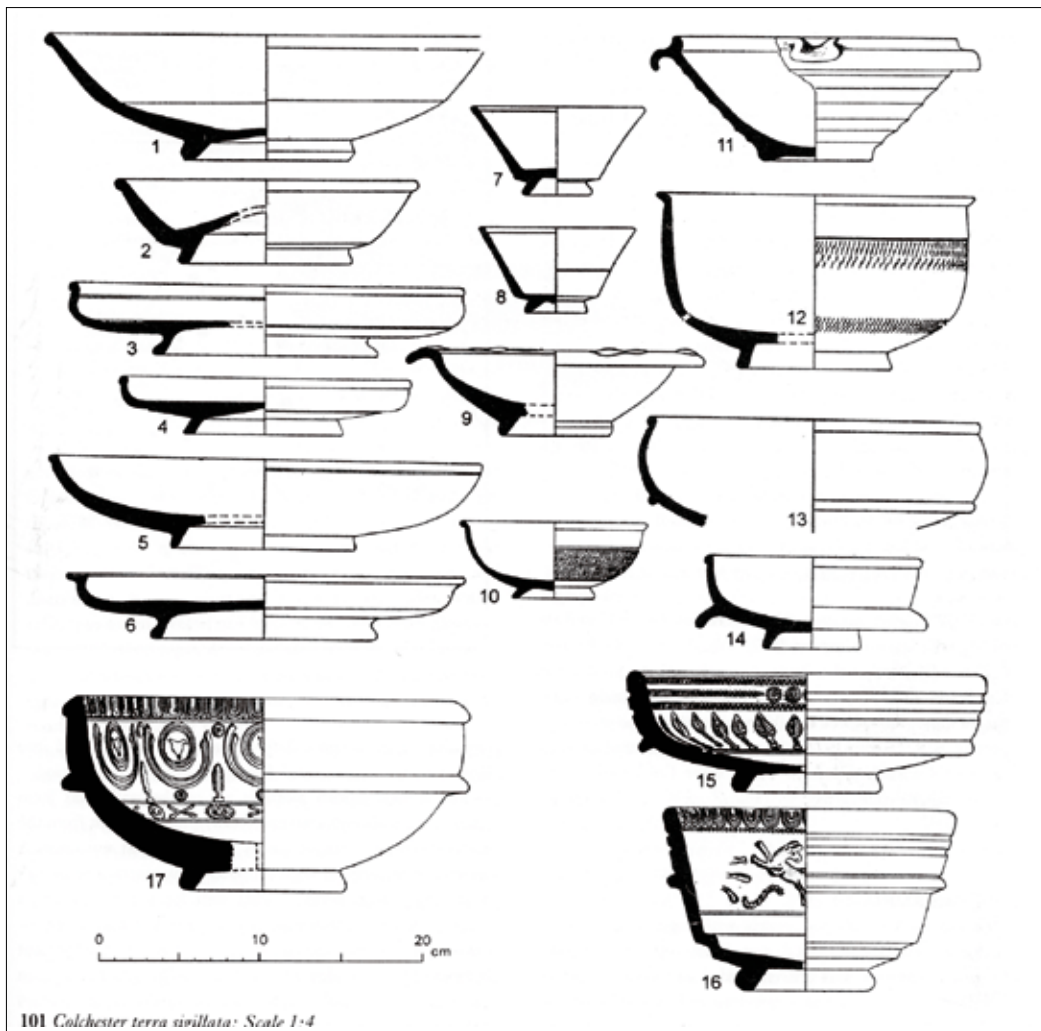

Fig. 14 Colchester Sigillata (after Tyers 1966: Fig. 101)

HELVETIA

The Roman Empire never had a province Helvetia, Nevertheless, Walter Drack classified the Helvetische Terra Sigillata Imitationen as early as 1945, and for quite a long time, his book offered one of the few available references. Locally made, sigillata-inspired shapes produced in different techniques are the starting point for his definition.

Ample bibliography is available. For a general approach, *Römische Keramik in der Schweiz* still is the most comprehensive where the paradigm change is easy to follow.

Four different coating and firing techniques produced red and black vessels, mostly of shapes very close to the Italic role models, frequently stamped in Italic tradition. One of the frequent early potters is *Vepotalus*. Early workshops are concentrated in the southern part of the country, but some are located in large Roman agglomerations like *Aventicum*, *Vindonissa* and *Augusta Raurica*.



Map 5 Helvetia (C. Ardis)

Relief Sigillata, not any more called imitation, is common. The repertoire follows the evolution of South and Central Gaulish pottery. Distribution is more or less restricted to the Roman sites in today's Switzerland and only rarely found beyond its boundary.

It is common among today's Swiss ceramologists to divide the groups established by Drack and call pottery made in the same techniques, perhaps even in the same workshops with other names. Carenated bowls Drack 20 to 22 form the group of *engobed ceramics of local form*, (= engobierte Keramik einheimischer Form) while second-century shapes both Roman and neo-Celtic ones belong to the group of *ceramics with a clay coating* (= Glanztonkeramik).

For a general view from outside the division into different groups just looks like a step towards practicability. It is the easier way when one has to process a large amount of finds. It certainly has nothing to do with ancient reality when tablewares inspired by different traditions made at the same time in the same workshop using similar technology are classified differently.

DACIA

Dacia came under Roman rule relatively late. Here, too, the Romans met with a highly developed pottery tradition that immediately started to manufacture things à la romaine in the 1st half of the 2nd century AD with the stamped pottery from Porolissum.

The native element is very shy. Almost no autochtone elements survived in the Roman pottery production of Dacia.

Potters travelling along with the army brought with them a strong influence of Pannonische Glanztonware. Quite soon, this merged into the local traditions and was transformed in a specific evolution that leads to complete emancipation (Rusu Bolindet et al. 2018: 230-279). Other workshops related to Porolissum are Apulum and Alburnus Maior. Grey stamped ware from Porolissum was also a prized export to the Barbaricum.

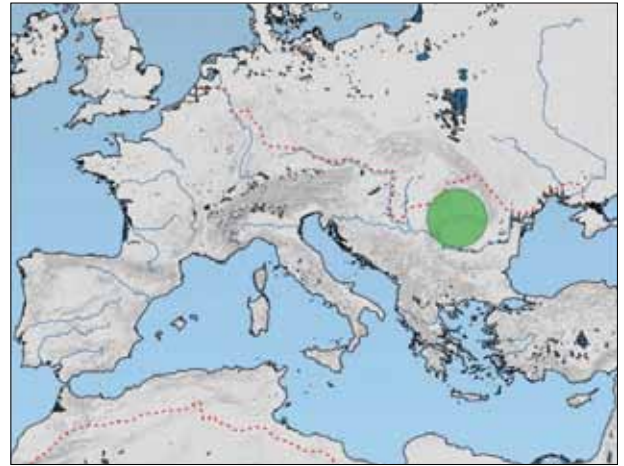

Map 6 Dacia (C. Ardis)

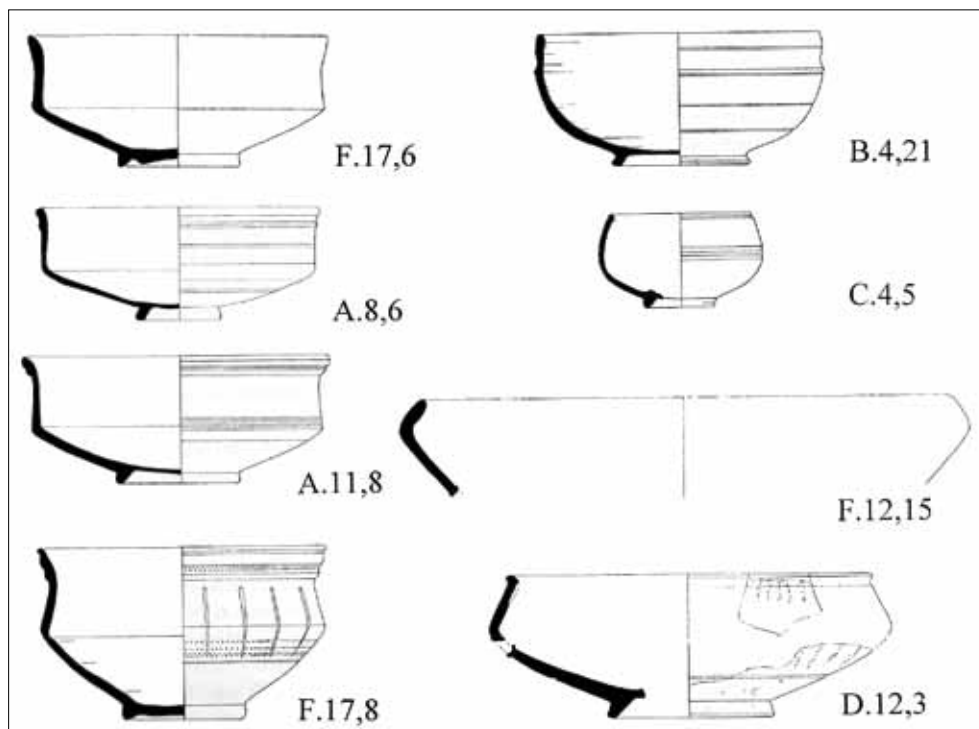

Fig. 15 Helvetische Ware Drack 20-22 (after C.Schucany 1999: Fig. 9)

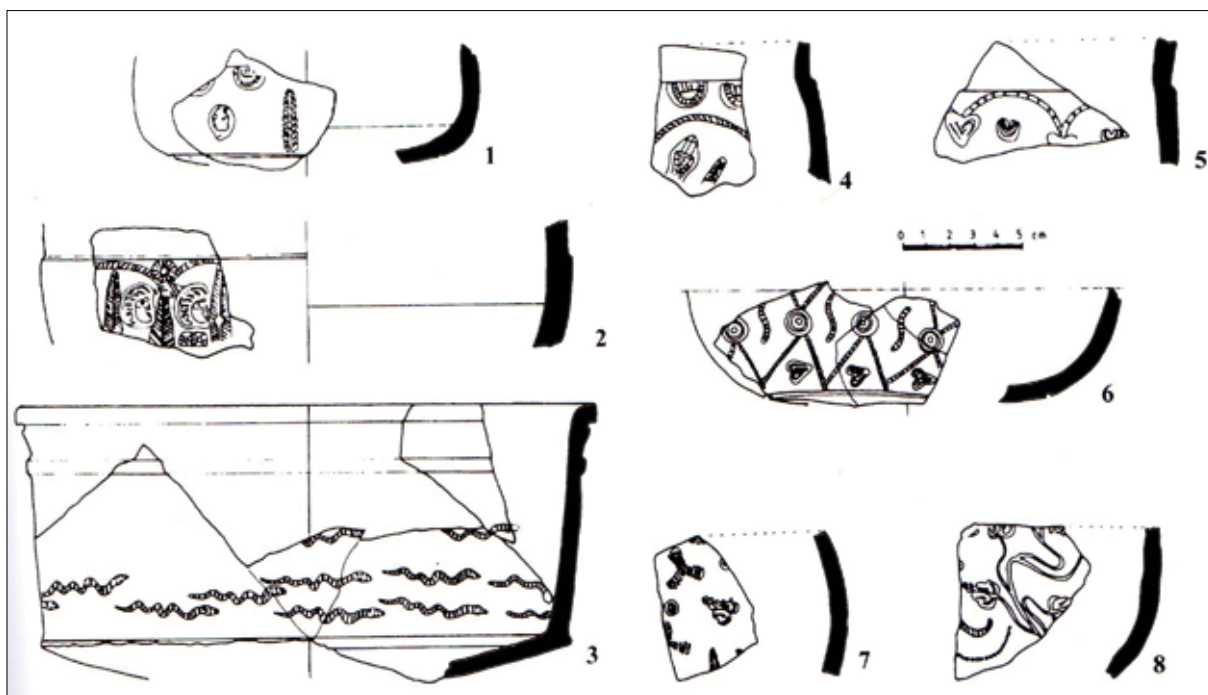

Fig. 16 Local Samian from Dacia Cluj-Napoca (after Rusu Bolindet 2018)

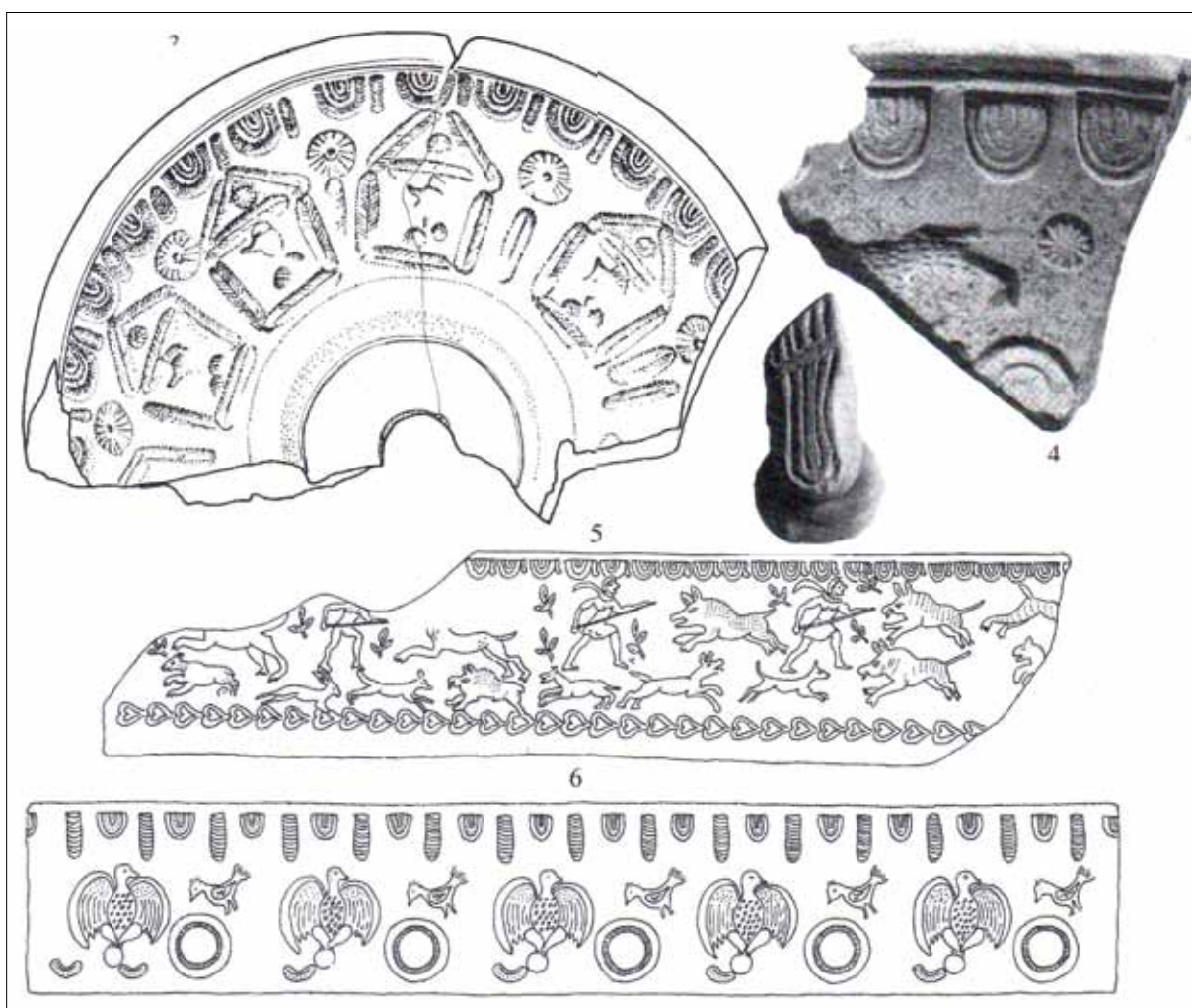

Fig. 17 Local Samian from Dacia Apulum (after Rusu Bolindet 2018)

The situation was different in Micăsasa, where influence from Central and Eastern Gaulish Sigillata imports was prevalent. It was supplemented with elements from Moesian Sigillata, mainly made in Viminacium-Margum. It seemed unaffected by the pottery centres of Pavlikeni, Butovo and Hotnica in Moesia Inferior, whose repertoire appear as a style guide in Southern Dacia workshops at Romula, Sucidava and Orlea in Oltenia. So in Dacia a kind of competition between the neighboring styles can be watched.

A paradigm shift occurred between 2001 when Romanian archaeology spoke of “céramique estampée” and 2014 when the term of *Local Samian* took over.

GREECE

Ceramologists busy with the Northwest rarely look to Greece when searching for analogies or differences, but the phenomenon can be traced in Greece also. Corinth provides the easiest example as it adds a couple of new facets to the topic.

History is different because there is a big gap of three generations. *L. Mummius Achaicus* destroyed Corinth in 146 BC. No pottery was manufactured for 100 years until Corinth was refunded in 44 BC.

Among the workshops that provided pottery for the inhabitants, Kathleen Slane observed two types. In Corinth, potters seem not to mix up their repertoires. A group (a society?) stick to Roman-style pottery, making genuine Eastern Sigillata B. Another group seemed to take inspiration elsewhere. Inspiration mainly of Italic role models is visible within the local typology.

Other potters prefer local neo-Corinthian shapes unrelated to international fashion. However, an influence medley similar to what occurs in Pannonische Glanztonware can be detected as well (Lelekovic 2018). It would be hazardous to imagine potters having migrated either from Italy or from Asia Minor.

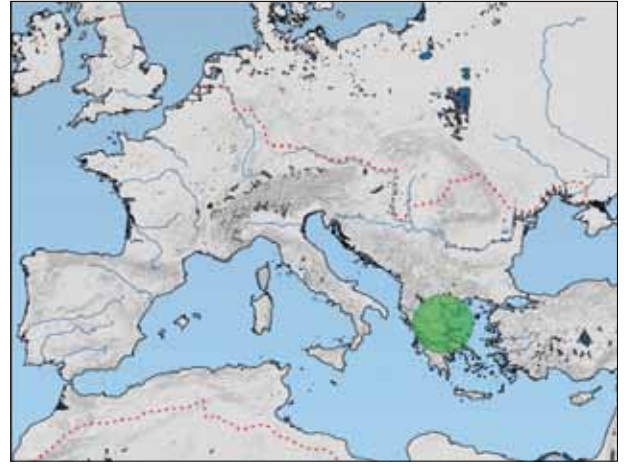

Map 7 Greece (C. Ardis)

The bowl Corinth Inv. C 1927-58 in Terra Sigillata Tardoitalica tradition with the stamped decoration and the double-dipping stripes offers an excellent example of fusion work.

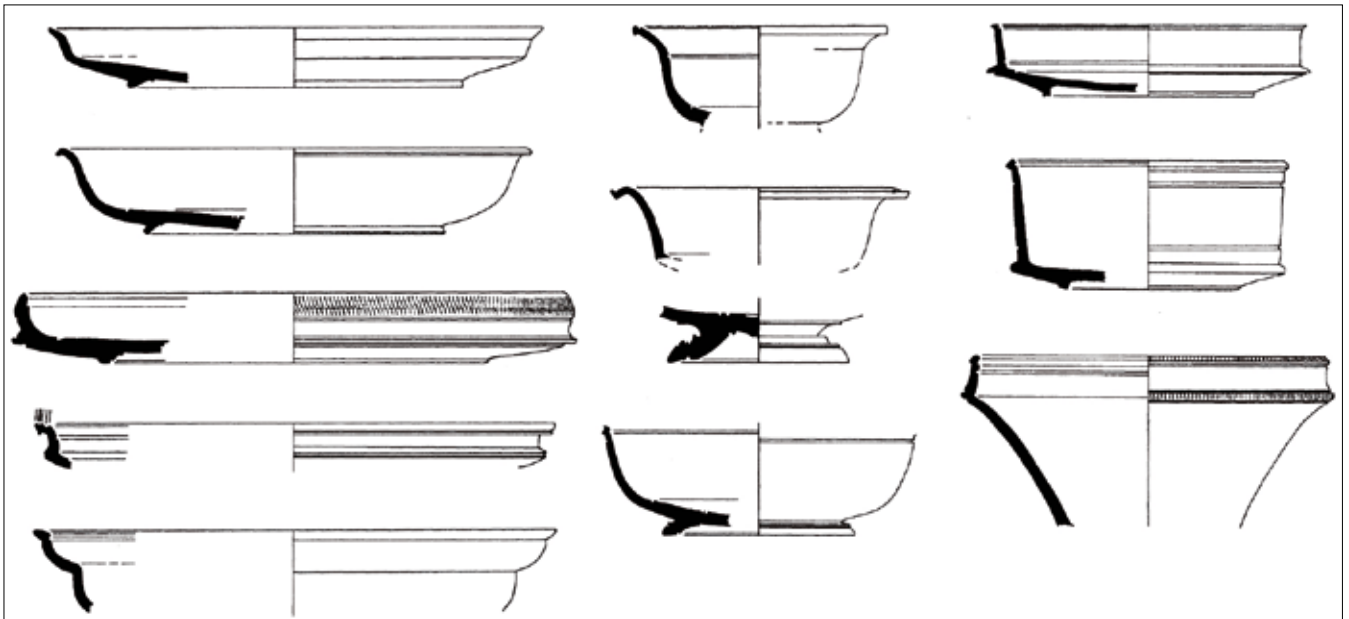

Fig. 18 Corinth ESB (after Hayes 1973: pl 86)

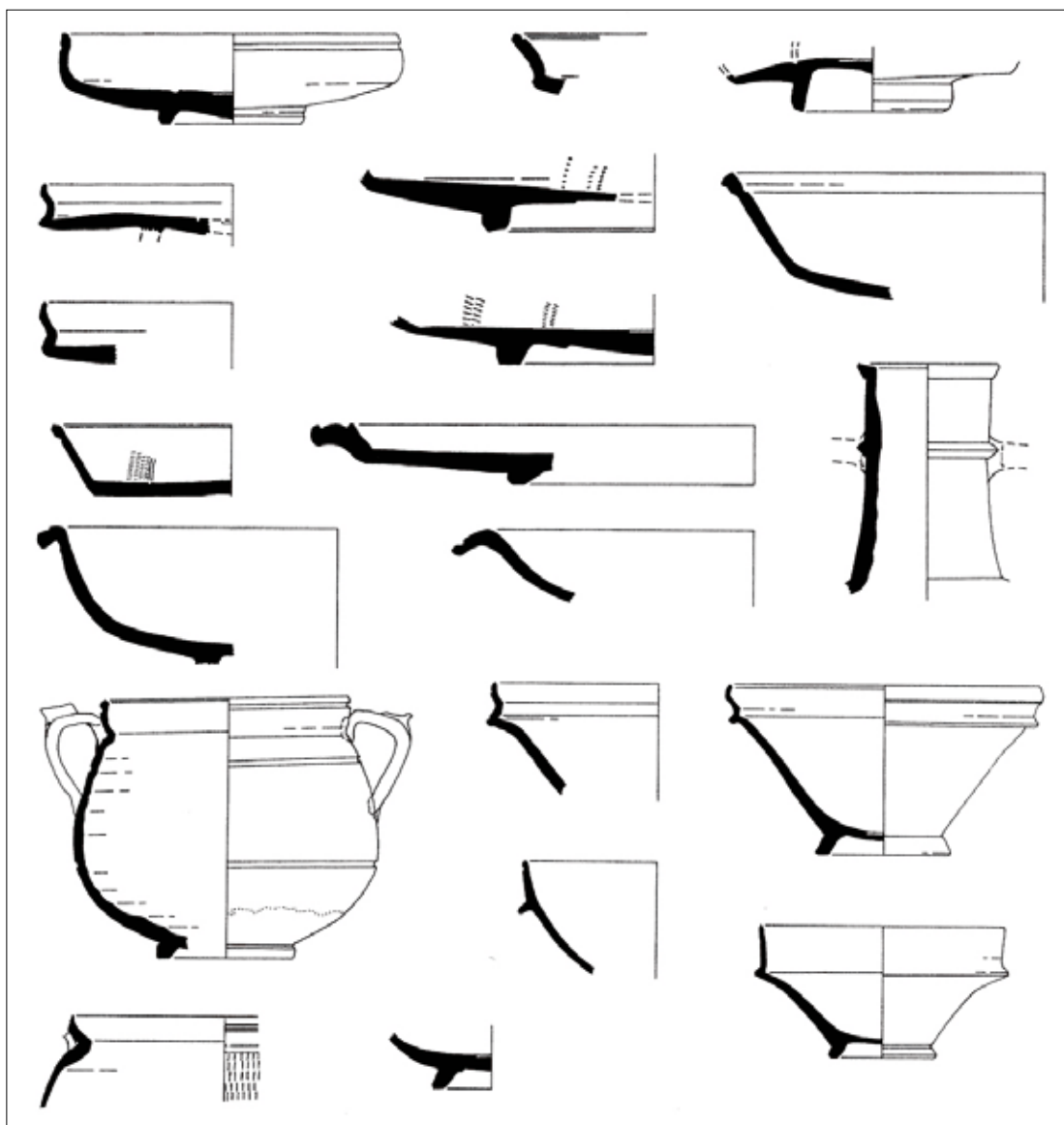

Fig. 19 Corinth Local grey and colour coated wares (after Hayes 1973: pl. 91)



Fig. 20 Corinth Local Drag 29 imitation of Terra Sigillata Tardoitalica fusion technique, (photo: ESK)

ITALIA

The trend to polyvalent workshops with mixed repertoires and regional importance can be observed in Italy from the middle of the second century AD onward. Until this time, production centres making Italic terra sigillata were active. In Padana the terra sigillata tardopadana potters, in Pisa and Etruria the TSTI potters and in Central Italy the OCT.PRO and OCT.SAL group.

Local production of relief ceramics in the style of Gaulish products from Aquileia has been brought to attention as early as 1934 when Giovanni Brusin defined some unorthodox shapes of Relief wares as local sigillata. Since he was not a pottery specialist, his assessment went to oblivion.

Many years later Franca Maselli Scotti investigated this group inspired by the Sigillée Claire B of the Rhône valley. A decent number of similar Relief bowls appeared in Verona and Brescia, and the examples recently started to expand the knowledge (Mantovani, Stuani 2020).

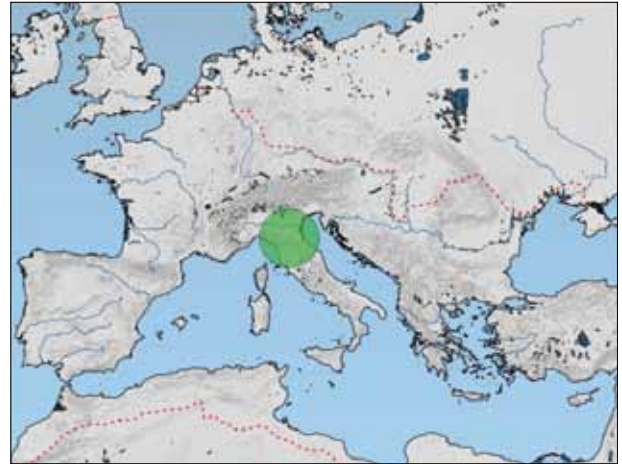

Map 8 Italia (C. Ardis)

Some 15 years ago, a polyvalent workshop was excavated in Padua. Products included practically all the goods in demand, from bricks and tiles to lamps. Potters made synchronic use of different techniques depending on what they were making (Cipriano, Mazzocchin 2014). Some of the sigillata seems to take inspiration from Pannonische Glanztonware. Caution is needed because the dating of the different phases of this workshop might not be completely safe.



Fig. 21 Aquileia Museo Archeologico Nazionale Local Terra Sigillata tarda from Aquileia (Foto: ESK)



Fig. 22 Padova Via Montona, Local Terra Sigillata tarda from Padova (Foto: ESK)

Ceramica Medioadriatica has been known for some time now, but it was not an export runner. Shapes are almost exclusively African inspired. They do not come in slipped sigillata surfaces but prefer painted and céramique à la brosse features.

No renewal of old local types can be detected in the Italic workshops, a big difference to parallel provincial productions.

NORICUM

Back to Noricum and the Late Latène tablewares from the Magdalensberg. They are made in a fine slightly soapy fabric, mainly with silky surface varying from shiny, almost black to mat light grey in colour. All over the Celtic dominated horizon from Spain to Austria wheel-thrown vessels bear a smooth, slightly soapy surface in different shades of grey, while surface treatment may vary from none to polishing, burnishing and in some rare cases even coating.

The picture stands for more than just beauty. It is a symbol for the takeover of Italian feeling. Therefore, we can watch the effects of annexation, not reduced to political constraint or tribute pay. People were completely free to use the dinnerware they wanted, and they wanted Roman shapes. Depending on the personal point of view of the researcher, this will be perceived as infiltration by Roman invaders or as an opening to Mediterranean life style. Some prefer to write of imitation; others call it inspiration with all the semantic implications that will follow.



Map 9 Noricum (C. Ardis)



Fig. 23 Magdalensberg Italic Sigillata and local grey wares (Foto K. Gostencnik)

In locally made drinking vessels, an explicit break in the sequence of shape and fabric occurs. Around the middle of the first century BC, conical or biconical family or friendship cups with a capacity of more than half a litre -1 sextarius- were common.

Consumers switched to much smaller imported drinking vessels only rarely copied by Noric potters. The answer of the local potters was to invent a completely new form in concordance to the consumers' demands. The coarse ware beakers have a Celtic touch, although there is no evidence of local forerunners.



Fig. 24 Magdalensberg evolution from Latène Drinking cup to Roman beakers (Foto: ESK)

In difference to the Western Celtic world in the Alpine countries wine seems mostly unknown before the arrival of Roman merchants, but it quickly finds a place in the course of life. Along with the taste comes the habit of mixing it with water, probably because otherwise it was unpalatable. Imported early Tiberian thin-walled cups act as godparents for a newly created wine service with a big water container, a medium-sized wine container and two different individual drinking cups. It is interesting to compare the size of the individual Roman cup with the old Celtic friendship cup.



Fig. 25 Magdalensberg Wine container and drinking cup set (Foto: ESK)

SOME CONCLUDING REMARKS

Our early scientific ancestors had other priorities in pottery studies. Rarely did they try to reconstruct pottery making, set aside to assess the different techniques and workflows in local workshops as opposed to the traditional study concept of Roman tableware traded on a large scale only.

Pottery workshops were once considered as highly specialized pre-industrial production centres with an assembly line like work division. They offered a restricted but highly recognizable repertoire, clearly divided from local and home production. With the number of multi-repertoire units excavated in the last 20 years, this hypothesis went out of fashion.

Martin Auer's fundamental work "Zur Organisation des Töpferhandwerks" with its classification of production types implicates the isochronic presence of various economic models long way off from the primitivist's concept.

Migrant workers, *Ceramisti migranti*, were not a topic in earlier reflections. Objects in motion and, therefore, copy of a present bodily example was the only possible prospect.

Local potters inspired by international fashion would "forge" or "fake" cheap imitations of expensive imports to dear for potential consumers. No other possibility than imitation could be imagined.



Fig. 26 Travelling pot (Drawing G. Ziliani)

Quality criteria

Ancient pottery was not supposed to remain buried in the earth for 2000 years. Therefore, today's archaeologists can only have an approximate and mainly wrong notion on how sigillata fired at 700 degrees in a direct flame kiln, not at 1065 degrees in a kiln with indirect heat, looked like when it was new. According to locally available primary materials and processing traditions, any discussion on high quality and sloppy and badly done things is obsolete since different production techniques were used Picon 2002 is still the best source to understand the problem. We know nothing about how it looked like in the cupboards of ancient homes. We don't know anything about quality criteria in antiquity. Twenty-two thousand discarded vases of the Fosse Malaval in La Graufesenque look better than most of the South Gaulish plain ware that reached many markets of the Imperium. Pottery specialists can only conclude today's specifications were probably of no consequence for possible quality criteria on the part of the potter, the merchant and the consumer. It is highly probable the archaeological assessment do not meet the valid requirements in antiquity. It is not for the archaeologist to decide whether regionally made sigillata was of lower quality and would be cheaper.

Transport costs

The same caution applies to discussions on transport costs. Hypotheses and even price calculations divagate mainly along the line of expensive long distance for the wealthy versus cheap regional for the paupers. Recent evidence for overland transport mixed with water transport, where frequent switches from animal and wagon to raft and ship happened, open the necessity for a new approach. Cost calculations for transports in the Roman period are an intellectual pastime from today's view.

French colleagues divide into *étude céramologique* and *approche archéologique*. In such a division of work, the ceramologist provides the sources, and the archaeologist develops the theory behind it.

There is a three-step pattern recognizable all over

As soon as a new fashion appears, the established regional craftspeople will immediately take possession of the newly circulating shapes. At the same time, they will continue to use their customary techniques.

Migrating potters will come along with the military and civil newcomers and bring a new push to the regional offer, sometimes going hand in hand with the addition of their own production techniques.

Less than a generation later, local craftspeople and newcomers will together have created a new repertoire, where Roman influence and reinvented traditions merge.

The dating of this mechanism depends on the arrival of the Romans. In Spain, it dates in the second century BC with a heavy component of black sigillata; in Belgium it happens in the last decades of the first century BC with Arretine shapes, in Dacia, it starts with the arrival of the Romans at the end of the first century AD with PGW prototypes.

Varieties are evident

In Corinth, there seem to be two workshop groups. Some potters make genuine Eastern Sigillata B while at the same time others prefer to work with the old local technology. In Britain Roman-style tablewares are inserted in a different way in the production program of the local pottery workshops. The London group invents its own repertoire with partial elusive roman influence. Colchester sigillata reflects the opening of a branch by potters of Eastern Gaul. At the same time, local productions of drinking vessels adopt shapes and decoration patterns popular in Gaulish colour coated and Rhineland wares.

Archaeological groups in material heritage are not necessarily congruent with the division created by the Roman administration. Helvetian Sigillata is an accepted group, while a Roman province of Helvetia never existed. Swiss archaeologists prefer to divide the classification established by Walter Drack for practical reasons. Still, they remain aware of the linkage and the interlocking (Stefanie Martin-Kilcher 1999, in *Römische Keramik der Schweiz* 89-93).

Strange as it may seem, regional specifics survive even in regions where a strong long-distance trade industry would eliminate all local business.

In general, the influence of more than one role model can remain side by side, both different, without merging into a new typology contemporaneously. In Italy African Red Slip brings the main antetypes for *ceramica medioadriatica*, while central Gaulish relief sigillata plays the same role for the Verona group. Some influence of the only shyly present Pannonische Glanztonware appears in the sales offer of the Padova workshops. Viorica Rusu Bolindet was able to identify a similarly generous range of role models in the Dacian production facilities.

Travelling potters

The present study takes into account the possibility of migration of craftspeople as known from sigillata productions. Roman potters move to newly established provinces under the protection, but not necessarily always under the army's rule. They bring their skills and their repertoire and adapt to locally present techniques while the local workshops add the Roman shapes to their regional repertoires. The next step (or the next generation?) is creating a new set of shapes with allusions to old native forms and the evolution of imported tableware to meet specific regional requirements.

This procedure can be followed from the Iberian Peninsula to Eastern Sigillata B workshops in newly implanted Corinthian workshops. Some replaced those of long-standing others were implemented in existing grouped crafts villages where newly arrived potters worked side-by-side with the native craftspeople. This connection often creates a field of activity where completely new styles emerge.



Fig. 27 Migrating potter (Drawing G. Ziliani)

Added to this are new eating habits that require new tableware fashions while newly available food components lead to new recipes and alterations in the ways of cooking. A substantial change of everyday life leads to new crockery and pantry ware requirements, just like in the tableware.

Far and long gone is the traditional image of Romanization

When setting together two concepts familiar to scholars, the paradigm shift in the scientific approach of this complex situation becomes visible.

The traditional view works with the vessel brought in from outside, which considered the local product as a simplified copy made by the regional potter. In the current hypothesis, the migrating potter takes centre stage. Along with his tools, he brings his skills, his knowledge and his creativity to his new workplace, in most cases probably also his little helpers.

Suddenly the image undergoes a substantial modification. Instead of uneducated savages needing to copy the creative Romans, the local potters become skilled artisans open to new cooperation systems. The pattern changes, and local production loses any flavour of inferior quality. It just becomes different.

Romans and Natives are standing on the same level. This applies to the craftspeople and the merchants as well as to those who buy goods manufactured the modern Roman way in nearby workshops. They change from childlike persons who crave something shiny to responsible, independent consumers.

In order to establish the survey that combines ideas and considerations by no means new, it has been tried to keep up with references until 2018 and to eliminate everything not valid any more. However, for a general overview, it is always preferable to stick to comprehensive studies and not get lost in detailed papers.

BIBLIOGRAPHY

- Auer, M. 2014, Zur Organisation des Töpferhandwerks in Noricum. Familienunternehmen oder Großbetrieb? *Ethnographisch-Archäologische Zeitschrift* 55, 119–156.
- Baur, Ch., Schindler Kaudelka, E. 2015, Magdalensberg. Zur Auswertung augusteischer Planierschichten – Akkulturation am Beispiel der einheimischen Keramik. Lohner-Urban U.
- Scherrer P. (Eds.), Der obere Donauraum 50 v. bis 50 n. Chr. Region im Umbruch, Band 10 Berlin, 35–70
- Bernal, Casasola, D., Ribera i Lacomba, A. (Eds). 2008, *Ceramicas Hispanorromanas. Un Estado de la cuestion*, Cadiz.
- Bonis, E. 1942 *Die Kaiserzeitliche Keramik von Pannonien*, Budapest.
- Brukner, O. 1981, *Rimska Keramika u Jugoslovenskom Delu provincije Donje Pannonje*, Beograd 1981.
- Déchelette J. 1904, *Les vases céramiques ornés de la Gaule romaine*, Paris.
- Deru, X. 1996, *La céramique belge dans le nord de la Gaule. Caractérisation, chronologie, phénomènes culturels et économiques*, Louvain-la-Neuve 1996.
- Drack W. 1945, *Die helvetische Terra Sigillata-Imitation des 1. Jahrhunderts n. Chr.* Basel.
- Fernandez Garcia I. and Roca Roumens M. 2008, *Producciones de Terra Sigillata Ispanica* In *Ceramicas Hispanorromanas* 2008, 307-332.
- Gugl Ch., Sauer R. 1998, Mittelkaiserzeitliche Feinkeramik aus den Wohnterrassen von Teurnia - St. Peter in Holz, Kärnten. *Fundberichte aus Österreich* 37, 213-244.
- Hayes J. W. 1973, Roman Pottery from the South Stoa at Corinth, *Hesperia* 42 416-470.
- Loeschcke S. 1909, *Keramische Funde in Haltern*, Münster.
- Luginbühl Th. 2001, Imitations de sigillée et potiers du Haut-Empire en Suisse occidentale. Archéologie et histoire d'un phénomène artisanal antique. *Cahiers d'archéologie romande* 83 Lausanne
- Morillo A. 2008, Producciones Ceramicas militares en Hispania, In *ceramicas Hispanorromanas* 2002 275-295.
- Mantovani, V., Stuardi, R. 2020, Terra sigillata decorata a matrice di media età imperiale da Verona: Nuovi dati sulle produzioni norditaliche, *RCRF Acta* 46, 101-112.
- Maselli Scotti, F. 2008, Terra sigillata tarda tra Aquileia e Trieste. *RCRF Acta* 40, 309-314.
- Mazzocchin St., Cipriani S., Maritan L. 2014, Il quartiere di artigianale di via Montona a Padova: Le produzioni ceramiche e la loro caratterizzazione archeometrica, In: Lipovac Vrkljan, G. , Šiljeg, B., Ožanić Roguljić, I., Konestra, A. (eds.), *Rimske keramičarske i staklarske radionice. Proizvodnja i trgovina na jadranskom prostoru* Zbornik Instituta za arheologiju 2 Crikvenica, 199-218.
- Rudnick, B. 2001, *Die Römischen Töpfereien von Haltern*. Münster.
- Rusu Bolindet V., Roman C-A., Gui M., Iliescu A., Botiș F, Mustaja S, Petrut D. (Eds). 2018, *Atlas of Roman pottery workshops from the provinces Dacia and lower Moesia/Scythia Minor (1st -7th centuries AD)*. Cluj-Napoca.
- Schindler Kaudelka E. 2002, Importe aus Italien – von norischen Töpfern umgewandelt. K. Kuzmová/K. Pieta/J. Rajtár (Eds.), *Zwischen Rom und dem Barbaricum. Festschrift für Titus Kolnik zum 70. Geburtstag*. *Communicationes Instituti Archaeologici Nitriensis Academiae Scientiarum Slovacae* 5 Nitra 193-199.
- Picon M. 2002, À propos des sigillées, présigillées et imitations de sigillées : questions de « coûts » et de marchés. S.F.E.C.A.G. Actes du congrès de Bayeux, Marseille, 345-356.
- Schindler Kaudelka E. 2015, Gobelet celtique, forme romaine. Adaption ou création d'un nouveau répertoire par les potiers du Norique? In: Lemaître, S., Batigne Vallet, C. (Eds.), *Abécédaire pour un archéologue lyonnais. Mélanges offerts à Armand Desbat*. *Archéologie et Histoire Romaine* 31, Autun, 325-328
- Schörgendorfer A. 1942, *Die Römerzeitliche Keramik der Ostalpenländer* Wien.
- C. Schucany/S. Martin-Kilcher/L. Berger/D. Paunier (Eds.), 1999 *Römische Keramik in der Schweiz. Céramique romaine en Suisse. Ceramica romana in Svizzera*. *Antiqua* 31. Veröffentlichungen der Schweizerischen Gesellschaft für Ur- und Frühgeschichte Basel
- SFECAG 2018, Actes du Congrès de Reims, 10-13 Mai 2018. Marseille.
- Slane K. W., Dickie M.W. 1993, *A Knidian phallic vase from Corinth*, *Hesperia* 62, nr. 4, 483.
- Tyers P. 1996, *Roman pottery in Britain*, London.

ELECTRONIC SOURCES

- Leleković, T. 2018 How were Imitations of Samian Formed?, *Internet Archaeology* 50. <https://doi.org/10.11141/ia.50.18> Consulted January 21st 2021
- The Pannonian grey ceramics, no authors no year <https://www2.rgzm.de/Transformation/Magyarorszag/Glanztoware/GlanztowareEnglisch.htm> Consulted January 21st 2021
- Porsherd. Atlas of Roman pottery in Britain <http://potsherd.net/atlas/potsherd> Consulted January 21st 2021

SAŽETAK
PANONSKA KERAMIKA S PREMAZOM.
POSEBAN SLUČAJ U SREDNJOJ EUROPI ILI SAMO OPĆENITI OBRAZAC
RIMSKE KERAMIKE?

Ključne riječi: panonska keramika s premazom, proizvodnja regionalne stolne keramike, radionice s raznolikim proizvodima

Gdje god bi Rimljani stigli, naišli bi na keramičarsku proizvodnju razvijenu dovoljno kako bi zadovoljila potrebe lokalnog stanovništva. Rimljani su donijeli svoje prehrambene navike, a njihova je prtljaga sadržavala posuđe i kuhinjski pribor. Rimski obrtnici su se doseljavali među prvima doselili i otvarali radionice na tek osvojenom teritoriju. Regionalni lončari brzo su integrirali rimsku modu u svoju proizvodnju, zadržavajući svoje provjerene tehnike. Oblici dodani regionalnom repertoaru, umjesto da ga istiskuju, bili su jednostavni i prilagođeni lokalnim uvjetima i primarnim izvorima. Već je generacija kasnijih lončara i lokalnih i doseljenih surađivala kako bi stvorila zajedničku svakodnevnu kulturu kada je novi skup oblika koji su koristili pojedinačne elemente koji se smatraju autohtonim proširio repertoar. Ovo nije jedinstvena pojava, već zvučni znak načina života u tadašnjem rimskom svijetu. Mehanizam je jednak u svim rimskim provincijama od današnje Španjolske do Rumunjske, od Britanije do Grčke i Turske, ali karakter tanjura, zdjela, čaša i vrčeva različit je prema regionalnim potrebama i tradiciji.

INTRODUCTION TO PANNONIAN SLIPPED WARE IN CROATIA

In this paper we are giving a short overview of the forms that appear in Southern Pannonia and proposing the division of production in two areas: Southwestern and Southeastern group of Pannonian slipped ware (PSW). Published sites with PSW are listed to show the wide spread appearance of most of the sites of the Croatian part of southern Pannonia. The main idea of the paper is to show its significance in this region and to create a fixed point from which a more comprehensive study can be made.

Key words: Southern Pannonia, Pannonian slipped ware, Roman pottery

INTRODUCTION

Pannonian slipped ware (PSW) belongs to the pottery class as a typical and widespread product. It was produced in various areas of the province of *Pannonia* but also in *Noricum* and *Moesia*. A general description of this ware is that the dishes were made on the wheel, the surface is slipped, and most often undecorated, but can be also decorated by rouletting or stamping, or a combination of the two, and fired in reducing or oxidizing atmospheres: as a result, there are black, grey, red, orange vessels.

The vessels' forms include several types of spherical bowls and plates and jugs, cups, and beakers. The production started in the 2nd half of the 1st century AD, and it was produced in the western part of *Pannonia* until the end of the 2nd c. In the eastern part of *Pannonia*, the production lasted in the 3rd c. But, as we now know, some shapes appear until Late Antiquity. Its appearance is also described as high-quality pottery with a slip.

It appears on most Roman sites in the Croatian part of *Pannonia* (Map 1) but very often not recognized as PSW or called just an imitation of the *terra sigillata*. As it came in most countries, comprehensive work hasn't been written yet. It is usually studied in scientific analysis that deals with all classes of pottery (Vikić Belančić 1965; Brukner 1981) or as a part of a larger assemblage of the sites (urban, necropolis etc.) (Gregl 1989; Ožanić Roguljić 2016). Recently, more attention has been given to the *Pannonian* slipped ware as a separate class of pottery (Leleković 2018), and the distribution to *Dalmatia* and Northern Italy is also confirmed (Gregl 2009; Ožanić Roguljić, Konestra 2017; Dobreva, Mantovani 2017; Jelinčić Vučković, Botte 2018: 135; Konestra *et al.* in this volume).

This paper aims to show the state of research on Pannonian slipped ware in Croatia, to combine the knowledge of published material with new and available finds. In this work will also add a bibliography of PSW findings in Croatia that is not necessarily quoted in the text. The study in this paper has been done on published material from sites that show typological diversity, which can show the number of forms in southern Pannonia. Also, we will not repeat the analysis on PSW from *Siscia* and *Mursa* since there are papers dedicated to the state of research in this publication (see: Miletić Čakširan and Leleković in this publication).

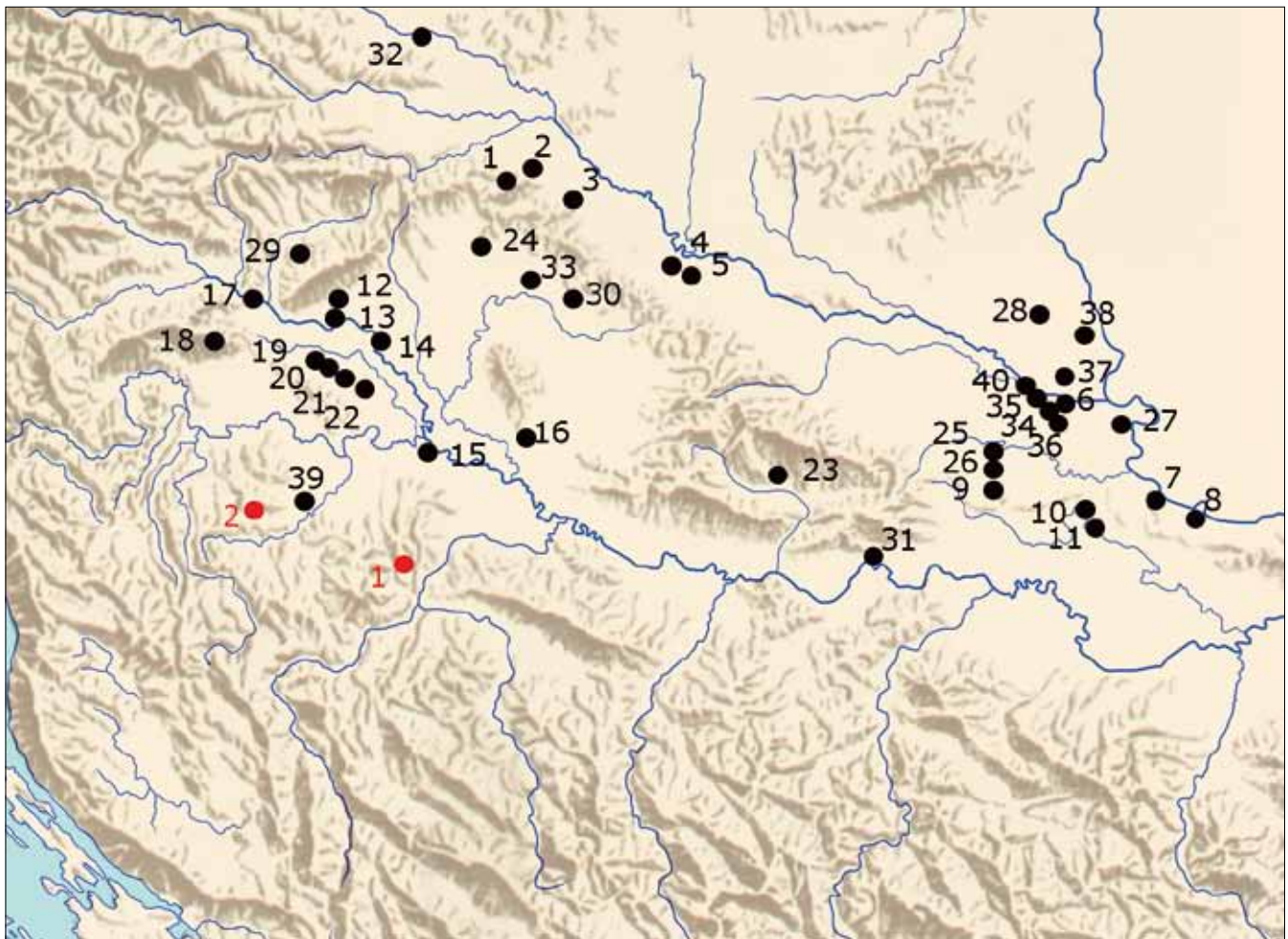

Map 1 Sites with PSW in Pannonia (Croatian part) (made by K. Jelinčić Vučković and I. Ožanić Roguljić)

THE DIFFERENT GROUPS OF SLIPPED WARE IN PANNONIA

In the bibliography, Pannonian groups of PSW were popularly divided: North West Pannonia; North East Pannonia and Southern Pannonia.¹

Southern Pannonia group is covered from Slovenia, NW Croatia and Serbia. The problem with this division is that the area is too large. There are many similarities between the western and the eastern regions, but there are differences that make the division of this region necessary. Several urban settlements (*Siscia*, *Mursa*, *Cibalae* and *Sirmium*) could easily have their production centres in such a large area. Lajos Nagy² found the workshop in *Siscia*, identical to the *terra sigillata* workshop there. Other circles of workshops can be found and based on the similar characteristics of the vessels in *Andautonia-Siscia-Neviodunum*, *Mursa* and *Sirmium*. Pottery production in *Siscia* is confirmed by the finds of the moulds and badly fired thin-walled pottery, but the actual large scale Roman production has not confirmed yet. One of the theories is based on the fact that the Roman kilns were recorded outside the city walls. Also, the clay pits functioned there from the 18th to the middle of the 20th century and could have destroyed Roman kiln sites (Miletić Čakširan 2019).

According to the current data, several pottery workshops operated in *Cibalae*. Kilns are located in more or less dense groups; some are singular and isolated from others (Iskra - Janošić 1995: 60; 2001: 108). In her monograph, Iskra-Janošić presented a detailed list of pottery kilns, and her topography map shows several workshop centres (Iskra - Janošić 2001: 107). In a recent research, kilns for pottery firing have been also discovered (Roksandić 2018: 44). None of this can be used for the confirmation of the PSW production in the mentioned urban area.

1 <https://www2.rgzm.de/Transformation/Magyarorszag/Glanzttonware/GlanzttonwareEnglisch.htm>

2 <https://www2.rgzm.de/Transformation/Magyarorszag/Glanzttonware/GlanzttonwareEnglisch.htm>

Table 1a List of sites with PSW (made by K. Jelinčić Vučković and I. Ožanić Roguljić)

Number on the map	Site	Literature	Context
1	Varaždinske toplice / <i>Aquae lasae</i>	oral communication, Archive of AMZ; <i>Aquae lasae</i> , <i>Aquae lasae</i> , najnovije rimske najdbe na območju Varaždinskih Toplic, Katalog izložbe, Cankarjev dom, Ljubljana, 21. maj – 26. oktobar 2014; Vikić-Belančić, Gorenc, 1958, Arheološka istraživanja antiknog kupališta u Varaždinskim Toplicama od 1953.-1955. godine, <i>Vjesnik Arheološkog muzeja u Zagrebu</i> , 3.s.c vol. I, Zareb, 76-127.	urban
2	Ludbreg / <i>lovía</i>	Jelinčić Vučković, K. 2012, <i>Stručno izvješće o rimskoj keramici iz Ludbrega (iskopavanja 2008.-2011.g.)</i> , elaborat, arhiva IARH, arhiva HRZ.	urban
3	Kunovec breg	Demo, Ž. 1982, Rezultati arheoloških iskopavanja ranocarske nekropole u Kunovec Bregu kraj Koprivnice (iskopavanja u 1979. i 1980. godini)", <i>Podravski zbornik '82</i> , Koprivnica, 279–327.	necropolis
4	Virovitica Kiškorija South	Jelinčić, K. 2012. <i>Ceramica Romana tardo antica dal villaggio Romano Virovitica Kiškorija jug (Pannonia Superior) dalle unità stratigrafiche datate mediante 14C, Rei Cretariae Romanae Favtorvm, Acta 42, 69-79</i> ; Jelinčić, K. 2015, <i>Rimsko selo u provinciji Gornjoj Panoniji: Virovitica Kiškorija Jug</i> . Monographiae Instituti Archaeologici 7, Zagreb, 114-118, 165-167.	urban
5	Orešac / <i>Bolentio</i>	Jelinčić, K. 2008, Probno arheološko istraživanje u Orešcu 2007, <i>Annales Instituti archaeologici</i> , IV, 40-43.	urban
6	Osijek / <i>Mursa</i>	Šimić, J., Filipović, S. 1997, <i>Kelti i Rimljani na području Osijeka</i> , Osijek.	urban
7	Sotin / <i>Cornacum</i>	oral communication; Mato Ilkić	field survey
8	Ilok / <i>Cuccium</i>	Jelinčić Vučković, K. 2011, Roman Pottery Finds from Ilok – Castle of the Dukes of Ilok Site Excavations (2001-2004), EMAC 2011 11th European Meeting on Ancient Ceramics, Poster presentation.	
9	Štrbinci / <i>Certissia</i>	Migotti, B., Šlaus, M., Dukat, Z., Perinić, Lj. 1998, <i>Accede ad Certissiam: antički i ranokršćanski horizont arheološkog nalazišta Štrbinci kod Đakova</i> , Đakovo, Zagreb.	urban
10	Vinkovci / <i>Cibalae</i>	Iskra – Janošić, I. 1995, Zaštitna arheološka istraživanja u 1994. godini, <i>Godišnjak Ogranka Matice hrvatske Vinkovci</i> , 12, Vinkovci, 60; Iskra – Janošić, I. 2001, Urbanizacija Cibala i razvoj keramičarskih središta, Vinkovci. 108; Ožanić, I. 2004, Tipologija rimske keramike iz Vinkovaca, Magistarski rad, Sveučilište u Zagrebu; Ožanić Roguljić, I. 2016, <i>Tipologija rimske keramike iz Vinkovaca</i> , Monographiae Instituti archaeologici, 10, Zagreb.	urban
11	Liskovac	Ožanić Roguljić, I. 2009, Rimski nalazi s lokaliteta Liskovac -Južna obilaznica Vinkovaca, Prilozi Instituta za arheologiju u Zagrebu, Vol. 26. 79–142.	rural settlement
12	Zagreb – Stenjevec	Gregl, Z. 1989, Zagreb – Stenjevec, Zagreb; Gregl, Z., Jelinčić, K. 2010, O nekim manje poznatim antičkim lokalitetima u Zagrebu i okolici, <i>Vjesnik Arheološkog muzeja u Zagrebu</i> , Vol. XLIII, 157, 164-165, 173-175.	necropolis
13	Lašćinščak	Gregl, Z., Jelinčić, K. 2010, O nekim manje poznatim antičkim lokalitetima u Zagrebu i okolici, <i>Vjesnik Arheološkog muzeja u Zagrebu</i> , Vol. XLIII, 154, 160, 167.	field survey
14	Ščitarjevo / <i>Andautonia</i>	2000 godina Andautonije : od rimskog grada do arheološkog parka, In: [katalog izložbe] / Dorica Nemeth-Ehrlich, Dora Kušan Špalj, Zagreb, 2007.	urban

Number on the map	Site	Literature	Context
15	Sisak / <i>Siscia</i>	Wiewegh, Z. 2001, Rimska kovnica iz Siska s lokaliteta "Kovnica", <i>Opuscula Archaeologica</i> , 25, 98–149; Vidošević, I. 2003, Rimska keramika s lokaliteta Starčevićeve ulice 37 u Sisku, <i>Godišnjak Gradskog muzeja u Sisku</i> , sv. III-IV, Sisak, 11–74; Wiewegh, Z. 2003, Jugoistočna nekropola Siscije, Sisak; Zaštitna arheološka istraživanja Gradskog muzeja Sisak 2000.-2010. Archaeological conservation research of the City Museum Sisak since 2000. until 2010., katalog izložbe, Sisak, 2011; Miletić Čakširan, I. 2019, <i>Tipološko kronološka klasifikacija rimske keramike iz Siscije</i> , doktorska disertacija, Filozofski fakultet u Zagrebu, Zagreb.	urban
16	Osekovo	oral communication	urban
17	Drenje	Škoberne, V., Košćević, R., Makjanić, R. 1987, <i>Drenje</i> , Brdovec.	rural settlement
18	Gornja Vas	Gregl, Z. 2007, <i>Rimskodobna nekropola Gornja Vas na Žumberku</i> , Zagreb.	necropolis
19	Gornji Čehi	Gregl, Z., Jelinčić, K. 2010, O nekim manje poznatim antickim lokalitetima u Zagrebu i okolici, <i>Vjesnik Arheološkog muzeja u Zagrebu</i> , Vol. XLIII, 154, 159, 166.	field survey
20	Donja Lomnica	Gregl, Z., Jelinčić, K. 2010, O nekim manje poznatim antickim lokalitetima u Zagrebu i okolici, <i>Vjesnik Arheološkog muzeja u Zagrebu</i> , Vol. XLIII, 159, 166.	field survey
21	Mala Mlaka – Ciglenica	Gregl, Z., Jelinčić, K. 2010, O nekim manje poznatim antickim lokalitetima u Zagrebu i okolici, <i>Vjesnik Arheološkog muzeja u Zagrebu</i> , Vol. XLIII, 155, 160-161, 167-168.	field survey

Table 1b List of sites with PSW (made by K. Jelinčić Vučković and I. Ožanić Roguljić)

Number on the map	Site	Literature	Context
22	Mala Mlaka – Starče	Gregl, Z., Jelinčić, K. 2010, O nekim manje poznatim antickim lokalitetima u Zagrebu i okolici, <i>Vjesnik Arheološkog muzeja u Zagrebu</i> , Vol. XLIII, 155, 161-162, 170-171.	urban
23	Tekić	oral communication, Mirela Pavličić hein	urban
24	Kalnik-Igrišće	Vrdoljak, S., Kudelić, A 2019, <i>Kalnik-Igrišće, Naselje kasnog brončanog doba</i> , <i>Monographiae Instituti archaeologici</i> , XIV, Zagreb, 43-44, Fig. 4.11.; Karavanić, S., Kudelić, A. 2013, Rezultati arheoloških istraživanja lokaliteta Kalnik-Igrišće, <i>Annales Instituti Archaeologici</i> , Vol. IX, 92.	rural settlement
25	Petrovci	oral communication, Ivana Hirschelr Marić	rural settlement
26	Ivandvor	oral communication, Tino Leleković	rural settlement
27	Dalj – <i>Teutoburgium</i>	oral communication, Archive of AMZ	military site
28	Popovac Mala Veka	Archive of IARH	field survey
29	Donja Stubica	Škiljan, I. 2019, <i>Tajne između Ivanšćice i Medvednice</i> , Gornja Stubica.	field survey
30	Bjelovar	Archive of IARH	rural settlement
31	Slavonski Brod (<i>Marsonia</i>)	oral communication; Ivana Artuković	
32	Sv. Martin na Muri	Andrašić, I. 2020, Rimska stolna keramika s nalazišta Sveti Martin na Muri (<i>Halicanum</i>) – istraživanja od 2015. do 2018.godine, <i>Diplomski rad</i> , Sveučilište u Zagrebu, Filozofski fakultet, Zagreb, 133-134, T. 19:92, https://urn.nsk.hr/urn:nbn:hr:131:977291 (datum preuzimanja:2021-01-21)	urban

Number on the map	Site	Literature	Context
33	Majur	Tkalčec, T., Karavanić, S., Šiljeg, B., Jelinčić, K. 2007, Novootkrivena arheološka nalazišta uz rječnu Veliku kod mjesta Majur i Ladinec, <i>Cris</i> , IX, 12, T. 5: 9.	field survey
34	Čepin - Rit	Ožanić Roguljić, I., Šiljeg, B. & Kalafatić, H. 2020, Prilog poznavanju topografije teritorija kolonije Elije Murse unutar dnevne zone kretanja (cotidianus excursus). <i>Annales Instituti archaeologici</i> , XVI, 71-77.	field survey
35	Čepin – Kravičke njive	Ožanić Roguljić, I., Šiljeg, B. & Kalafatić, H. 2020, Prilog poznavanju topografije teritorija kolonije Elije Murse unutar dnevne zone kretanja (cotidianus excursus). <i>Annales Instituti archaeologici</i> , XVI, 71-77.	field survey
36	Ivanovac – Veliki dioš	Ožanić Roguljić, I., Šiljeg, B. & Kalafatić, H. 2020, Prilog poznavanju topografije teritorija kolonije Elije Murse unutar dnevne zone kretanja (cotidianus excursus). <i>Annales Instituti archaeologici</i> , XVI, 71-77.	field survey
37	Darda – Luška	Ožanić Roguljić, I., Šiljeg, B. & Kalafatić, H. 2020, Prilog poznavanju topografije teritorija kolonije Elije Murse unutar dnevne zone kretanja (cotidianus excursus). <i>Annales Instituti archaeologici</i> , XVI, 71-77.	field survey
38	Dragojlov brijeg	Ožanić Roguljić, I., Šiljeg, B., Kalafatić, H. 2020, all Eppur si vede: Results of remote sensing and field survey of Dragojlov Brijeg (Croatia), Roman military site, <i>Arch. Bulg.</i>	field survey
39	Topusko	Kralj, M., Keramički materijal antičkog Topuskog iz istraživanja 2012. i 2013. Godine, Diplomski rad, Zagreb 2015	urban
40	Verušed	Lukić, K., Filipec, K. 2019, Antique and Late Antique fibulae, decorative items and certain accompanying finds from Verušed, <i>VAMZ</i> , 52. 83-111-ok	field survey
1	Osječenica	Ožanić, I. 1988, Gradina Osječenica - antičko razdoblje, <i>Opuscula archaeologica</i> , 22, 27– 80.	hilltop settlement
2	Petrovac	Jelinčić Vučković, K. 2013, Rimski keramika s lokaliteta Petrovac, <i>Prilozi Instituta za arheologiju u Zagrebu</i> , Vol. 30, 160, 165, T. 1: 21.	hilltop settlement

A close study of the published and some unpublished material shows us the list of 40 sites with PSW finds in the Croatian part of south Pannonia (Table 1a, Table 1b). Two sites mentioned on the list, Osječenica and Petrovac, are situated on the border of Pannonia and Dalmatia. There are also possibilities of other local production areas in today's Bosnia and Hercegovina - Dalmatia in the Roman period. The hilltop site Osječenica shows the range of PSW forms, of which some are with features that are different from the nearest possible production centre in *Siscia* (Ožanić Roguljić). It is possible that a local workshop operated in that region.

By inspecting and checking the fabric, forms and decoration, the production and distribution division can be made in two regions: **Southwestern** and **Southeastern**, as done with PSW groups in the northern part of *Pannonia*. Of course, some forms and decorations would always overlap, but we can see the differences induced by geographical reasons. Southwestern forms are the ones that were distributed to Dalmatia.³

Southwestern group

The problem that we are facing when discussing the southwestern group is that material is neither available for the fabric analysis nor the publication revision. Southwestern forms studied in this paper belong to the material from the necropolis Gornja Vas and Stenjevec. The material from Sisak is presented in this volume by Miletić Čakširan. In publications, fabrics of slipped pottery from the necropolis in northwest Croatia (Gornja Vas, Žumberak; Stenjevec) are described as grey-black, brown with grey slip, red and brown.

3 Imports are registered in Dalmatia and Italy (Ožanić Roguljić, Konestra 2017; Dobreva, Mantovani 2017; Jelinčić Botte 2018; Konestra *et al.*: in this volume)

Bowls (Pl. 1-3)

At Gornja Vas, eighteen bowls of the PSW group were found in graves dating from the middle 1st to middle of 2nd CE. Fabrics are divided into grey (10, 56%), red (7, 39%) and black (1, 5%). The hemispherical bowl belongs to a variant of the Drag 37 bowl. It is a trendy shape in Pannonia, which is present on many sites (Ožanić Roguljić 2016: 41). It is often decorated with grooves in combination with rouletting and stamped decoration (Plesničar Gec 1977: 54; Brukner 1981: 87; Adler – Wölfl 2004: 44; Nagy 2014: 119 – 127; Ožanić Roguljić 2016: 41). Simple hemispherical bowls sometimes have no decoration or several combinations of decoration (rouletting, rows of stamped leaves and rosettes) made only in grey fabrics (Pl. 2). Drag 44-like bowls are deeper bowls of larger dimensions with an annular thickening at the edge and a transition to the lower cone (Pl. 3). They were made black and red (Jeschek 2000: T 63: 10–14). Sometimes they have a groove along the edge on the inside and outside; often, traces of paint application can be seen (Gregl: 1989; 2007).

Plates (Pl. 4)

A simple flat bottom plate similar to the so-called “Pompeian plate” or “Soldatenteller” appeared in the 1st century, and some variants lasted until the 4th century. They are present in large numbers in Pannonia, but in Gornja Vas, there are only two. A shallow plate with a curved rim presented with thirty-one items at Gornja Vas. A similar shape is known in terra sigillata tardo Padana (Consp. 39), southern Gallic (Drag 36), and African sigillata. In Pannonian slipped ware, it is one of the most popular forms, which is present also in Gornja Vas (Pavić 2004: T 1: 3; Adler - Wölfl 2004: 33). Fabrics: grey (12, 39%) black (8, 26%), red (9, 29%), brown (2, 6%). A plate with a spread out rim appears only in Stenjevec (Gregl:1989; 2007).

Unknown group

The Site Osječenica showed a different style of slip and even forms (Pl. 5-6). Unfortunately, the site stratigraphy does not help us with the dating of the finds. The forms appear with the pottery recognized as Germanic pottery of 4th CE (Roksandić 2018). These forms and shapes may be the style of Pannonian slipped ware that appeared from 3rd CE onwards. Also, since the site is on the border of Pannonia and Dalmatia, still in Dalmatia, a possibility of a local production centre can be hypothesized (Ožanić 1998).

The forms that appear at the Osječenica site are the forms that recall sigillata Drag 37 but also a rare form RITT 9. Besides that, the Drag 37 gets variants informing of the rim’s profile, and several bowls have an almond shape profile of the rim. The slip of the bowl recalling RITT 9 is covered with a brownish-grey slip that is also a characteristic of the 3rd CE (Vikić-Belančić 1971: 95; Ožanić 1998: 30). Bowls with widened inward bend rim according to similar shapes made with lead glaze slip from Dumbovo can be dated in 4th CE (Brukner 1981: T 94, 171).

The slip of the shards is mostly shiny and of high quality, but sometimes strokes are visible (Fig. 1). In the material from Osječenica, an interesting bowl is found. Its rim has an almond shape profile; the walls are very thin, and the body is covered in the orange-red slip, whereas there is a decoration on the outer wall beneath the rim made in white colour (Fig. 2).



Fig. 1 PSW from Osječenica (photo by I. Ožanić Roguljić)



Fig. 2 Bowl with white decoration (photo by I. Ožanić Roguljić)

Southeastern forms

Southeastern forms discussed in this paper are based on the material from the urban context of *Cibalae*. Fabrics of the PSW are described in two publications using the macroscopic analysis of fresh fracture with the naked eye and with 50x digital lens (Dino-Lite Pro). (Ožanić Roguljić 2016: 97-98; Roksandić 2018: 59). The vessels can be divided into grey/black and red /orange pottery (Fig. 3,4). Under 50x magnification, fine white inclusions are visible, and they show a reaction on 19% hydrochloric acid - limestone, small red inclusions, tiny black particles, and tiny glittering particles can also be limestone. So-called incomplete oxidation is often visible in the section of vessels (Ožanić Roguljić 2016: 97-98). The X-ray Fluorescence (XRF) method was used to determine chemical structures and properties of pottery on only a few samples of pottery from Vinkovci. In the study by D. Roksandić, nine pottery samples were analyzed, two of them belonging to the PSW group. Analyzed samples showed the uniform distribution of elements, which led us to conclude that the pottery came from the same clay source, i.e. workshop (Roksandić 2018: 157). Those results are significant for further study of pottery workshops from *Cibalae*.

Bowls (Pl. 7-8)

Most of the bowls forms recall the shapes of terra sigillata like (Drag18/31, Drag 32, Drag 37, Drag 24/25, Drag 44, Curle 11, Drag 24/25, Drag 51, and Curle 15)⁴. A small bowl with a curved rim (3rd CE) can be considered as similar to the Drag 35/ Consp. 43 forms and thus can be connected with forms of *terra sigillata*. Other forms are made in the original style, like the small bowl with a curved rim and a hemispherical bowl with a slightly bevelled rim.

4 Drag 51 and Curle 15 forms were published by O. Brukner, so we do not have the exact fabric analysis.





fotografija strukture photo of fabric	premaz/slip	tipovi posuda types
1. 	1. 	Zdjele Z 1; Z 3.1; Z 8 Tanjuri T 1- 5; T 7 Bowls B 1; B 3 .1; B 8 Plates P 1-5; P 7
2. 	2. 	Zdjele Z 5; Z 7; Z 8 Z 10 Tanjuri T 1- 5 Bowls B 5; B 7; B 8; B 10 Plates P 1-5
3. 	3. 	Zdjele Z 5; Z 7; Z 9 Tanjuri T 1- 6 Bowls B 5; B 7; B 9 Plates P 1-6

Fig. 3 Fabrics of vessels with red slip (made by I. Ožanić Roguljić)

	Clay	Slip
1.	Evenly fired vessels, hard, white inclusions (limestone), black specks, glittering inclusions, less than 1 mm in diameter, density up to 10%	Glossy red slip
2.	Evenly fired dishes, soft, white inclusions (limestone), red inclusions (grog), black specks, glittering inclusions, less than 1 mm in diameter, u density up to 10%, with occasional inclusion of more than 1 mm	The orange – brownish slip
3.	One incompletely baked layer, soft, white inclusions (limestone), red and orange inclusions (grog), black specks, glittering inclusions, less than 1 mm in diameter, up to 10% density, with occasional inclusion of more than 1 mm	Very glossy red slip
		Surface - slip on the outer and inner surface was obtained in oxygen-rich firing atmosphere, sometimes there are traces of brush made during application of slip.

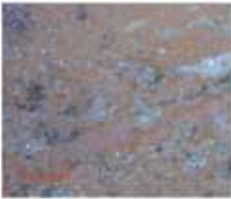
Table 2 Fabrics of vessels with red slip (made by I. Ožanić Roguljić)





fotografija strukture photo of fabric	premaz/slip	tipovi posuda types
<p>1.</p> 	<p>1.</p> 	<p>Zdjele Z 3.1; Z 5; Z 6; Z 7; Z 11 Tanjuri T 8 Bowls B 3.1; B 5; B 6; B 7; B 11 Plates P 8</p>
<p>2.</p> 	<p>2.</p> 	<p>Zdjele Z 3.2; Z 4 Tanjuri T 7; T 11; T 12 Bowls B 3.2; Z 4 Plates P 7; P 11; P 12</p>
<p>3.</p> 	<p>3.</p> 	<p>Zdjele Z 2; Z 5; Z 6; Z 7 Z 9; Z 11 Tanjuri T 7; T 9; T 10 Bowls B 2; B 5; B 6; B 7; B 9; B 11 Plates P 7; P 9; P 10</p>

Fig. 4 Fabrics of vessels with gray slip (made by I. Ožanić Roguljić)

	Clay	Slip
1.	With one incompletely fired layer, soft, white inclusions (limestone), black specks, fluorescent inclusions, less than 1 mm in diameter, density up to 10%	Gray glossy slip
2.	With multiple layers of incomplete burning, soft, white inclusions (limestone), black specks, sparkling inclusions of less than 1 mm in diameter, density up to 10%	Gray matte coating
3.	Hard, white inclusions (limestone), black specks, glittering Inclusion - less than 1 mm in diameter, density up to 10%	Very glossy black slip

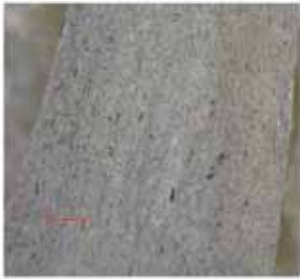
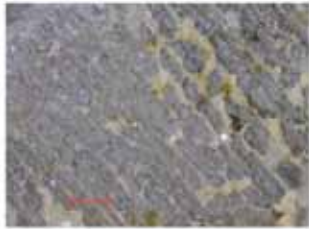
Table 3 Fabrics of vessels with gray slip (made by I. Ožanić Roguljić)

Plates (Pl. 9-10)

Varieties of flat bottom plates are the most common, followed by the plate with a curved rim that recalls Consp. 39/ Drag 36, and the original type is a plate with slightly curved walls and a straight rim and ringed bottom (Ožanić Roguljić 2016: 50-51). The plates are often decorated with rouletting and stamped leaves. Merchants were selling even defective goods at the market since some of the plates found in the urban context of *Cibalae* have errors like the leaf ornament stamped twice at the same place. (Ožanić Roguljić 2016: 52).

Other forms (Pl. 11)

In the definition of PSW, bowls and plates are the most common forms that are mentioned. But other forms also have a slip. Several logical questions arise. Do they also belong to the PSW style? Is the slip in these cases more functional to regulate vessel porosity?

The cups of Pannonian origin are mostly set into thin-walled pottery group, but some are too thick so that they can be added to the PWS group. Jugs and pots with two handles and special forms like the vessel with the grid also have slip (red or black/grey). A pot with two handles can have different functions, from tableware to storage ware. And a vessel with a grid has various interpretations proposed by scholars.

CONCLUSION

Local production of pottery played an important role in building the economy of the province. An enormous amount of Roman pottery, Pannonian slipped ware (PSW), is one of the key factors for understanding the chronology and amount of local production. Pannonian slipped ware used the production of the *terra sigillata* as an inspiration for the style, and in everyday consumption became even more popular as the tableware (Ožanić Roguljić 2016: 195, fig. 9.1). The reasons for its popularity are multiple, but the most obvious are probably the accessibility and lower price on the market. The style of PSW is influenced mainly by *terra sigillata*, but it shows its specific features in forms and even in colour. The slip is made in reddish colours but also in grey/black. Forms follow the shapes of *terra sigillata*, but many new original forms are also created. It is impossible to say which colours were more popular as it appears that both were made in the same workshops. The vessel's colour on the table was a reflection of the personal affection.

There are many problems regarding the research of this group of pottery in Croatia, mostly connected with the lack of publication. Through the work in this publication, we can pinpoint significant issues and make plans for the future.

Typology and analyses of decoration could be done to get a basic idea of PSW subgroups based on the published material. No conclusion could be made to redefine the groups of southern *Pannonia* because we lack data from the research of even bigger excavations and sites that would provide us representative samples of PSW pottery. There are only a few shards published from the sites in many cases. The lack of at least a simple fabric analysis from most of the sites is also a big problem for making more elaborate divisions of the groups in southern Pannonia.

Analyzing "the same" pottery group from different contexts and archaeological research gives miscellaneous data. For instance, the material published from *Mursa* and *Cibalae* is different, and *Mursa* material is from the necropolis and *Cibalae* material from the settlement. The typological diversity shows the significant difference visible in the material from the urban settlement and the necropolis. Still, that conclusion is also connected with the lack of publication, especially from dated stratigraphic units. Although the material from the field survey is important, it does not give us the site's context.

We suggest that the division of the southern Pannonian group could be classified into two: the Southwestern Pannonian group and the Southeastern Pannonian group hoping that the future research will define more precisely the production centres, distribution, typology, decoration and perhaps subdivision of the groups. The number of published kilns, fabric and other analyses, a small number of publications in general, is insufficient. Typological studies of decoration could be done to get a glimpse of the idea of PSW subgroups based on published material.

Although this paper aims to summarize the research in Croatia, we are aware that modern borders limit the significance of such a study. One has to consider the possible massive production in *Sirmium* and its surroundings, where the production of other pottery classes is proven and products were probably imported to Pannonian sites in Croatia now.

This paper is a kind of snapshot of the current research situation without a conclusion. There is a lack of research data regarding several more significant sites that would provide a more concrete database with a large amount of such ceramics. We can assume that three big centres like *Siscia*, *Mursa* and *Cibalae* were production centres, we cannot exclude the possibility of the smaller production centres in their surroundings.

ACKNOWLEDGEMENTS

This article results from the project LIFE ON THE ROMAN ROAD: Communications, trade and identities on Roman roads in Croatia from 1st – 8th c. AD, UIP-05-2017-9768, supported by the Croatian Science Foundation.

IVANA OŽANIĆ ROGULJIĆ
Institute of archaeology
Jurjevska 15
10000 Zagreb
iozanic@iarh.hr

KRISTINA JELINČIĆ VUČKOVIĆ
Institute of archaeology
Jurjevska 15
10000 Zagreb
kjelincic@iarh.hr

BIBLIOGRAPHY

- Adler-Wöfl, K. 2004, *Pannonische Glanztonware aus dem Auxiliarkastell von Carnuntum*, Wien.
- Aquae Iasae, najnovije rimske najdbe na območju Varaždinskih Toplic, Katalog izložbe, Cankarjev dom, Ljubljana, 21. maj – 26. oktobar 2014.
- Andrašić, I. 2020, *Rimska stolna keramika s nalazišta Sveti Martin na Muri (Halicanum) – istraživanja od 2015. do 2018. godine*, Diplomski rad, Sveučilište u Zagrebu, Filozofski fakultet, Zagreb, <https://urn.nsk.hr/urn:nbn:hr:131:977291> (datum preuzimanja:2021-01-21)
- Brukner, O. 1981, *Rimska keramika u jugoslovenskom delu provincije Donje Panonije*, Beograd.
- Dobreva, D., Mantovani, V. 2017, Ceramiche fini di produzione dalmata, retica e di Treviri ad Aquilea, *Zbornik III. međunarodnog arheološkog kolokvija. Rimske keramičarske i staklarske radionice. Proizvodnja i trgovina na jadranskom prostoru. 4. - 5. studenoga 2014*. Lipovac Vrkljan, Goranka et al. (ur.), 225-224.
- Demo, Ž. 1982, Rezultati arheoloških iskopavanja ranocarske nekropole u Kunovec Bregu kraj Koprivnice (iskopavanja u 1979. i 1980. godini)“, *Podravski zbornik '82*, Koprivnica, 279–327.
- Gregl, Z. 1989, *Zagreb – Stenjevec*, Zagreb.
- Gregl, Z. 2007, *Rimskodobna nekropola Gornja Vas na Žumberku*, *Vjesnik Arheološkog muzeja u Zagrebu*, Vol. 40 No. 1, Zagreb, 221-331. <https://hrcak.srce.hr/28840>
- Gregl, Z. 2009, O importu panonske keramike ukrašavane pečatima u Dalmaciju, *Jurišičev zbornik*, Zagreb, 198–205.
- Gregl, Z., Jelinčić, K. 2010, O nekim manje poznatim antičkim lokalitetima u Zagrebu i okolici, *Vjesnik Arheološkog muzeja u Zagrebu*, Vol. XLIII, 151-191. <https://hrcak.srce.hr/74573>
- Iskra – Janošić, I. 1995, Zaštitna arheološka istraživanja u 1994. godini, *Godišnjak Ogranka Matice hrvatske Vinkovci*, 12, Vinkovci, 125–131.
- Iskra – Janošić, I. 2001, *Urbanizacija Cibala i razvoj keramičarskih središta*, Vinkovci.
- Jelinčić, K. 2008, Probno arheološko istraživanje u Orešcu 2007, *Annales Instituti archaeologici*, IV, 40-43. <https://hrcak.srce.hr/file/54090>
- Jelinčić, K. 2012, Ceramica Romana tardo antica dal villaggio Romano Virovitica Kiškoriya jug (*Pannonia Superior*) dalle unità stratigrafiche datate mediante ¹⁴C, *Rei Cretariae Romanae Favtorvm, Acta* 42, 69-79.
- Jelinčić Vučković, K. 2011, Roman Pottery Finds from Ilok – Castle of the Dukes of Ilok Site Excavations (2001-2004), *EMAC 2011 11th European Meeting on Ancient Ceramics, Poster presentation*. https://www.academia.edu/6111965/Roman_Pottery_Finds_from_Ilok_Castle_of_the_Dukes_of_Ilok_Site_Excavations_2001_2004_
- Jelinčić, K. 2015, *Rimsko selo u provinciji Gornjoj Panoniji: Virovitica Kiškoriya Jug*. Monographiae Instituti Archaeologici 7, Zagreb.
- Jelinčić Vučković, K., Botte, E. 2018, Arheološko istraživanje na lokalitetu Novo Selo Bunje na otoku Braču, 2017. godine, *Annales Instituti Archaeologici*, XIV, Zagreb, 127-135. <https://hrcak.srce.hr/209239>
- Jeschek, G., Thuri L. 2000, *Die grautonige Keramik aus dem römischen Vicus fon Gleisdorf*, Veröffentlichungen des Instituts für Archäologie der Karl-Franzens Universität Graz Wien.
- Karavanić, S., Kudelić, A. 2013, Rezultati arheoloških istraživanja lokaliteta Kalnik-Igrišće, *Annales Instituti Archaeologici*, Vol. IX, 88-92. <https://hrcak.srce.hr/112040>
- Leleković, T. 2018, How were Imitations of Samian Formed? *Internet Archaeology*, 50 1; 18. <https://doi.org/10.11141/ia.50.18S>
- Miletić Čakširan I. 2019, *Tipološko kronološka klasifikacija rimske keramike iz Siscije*, doktorska disertacija, Filozofski fakultet u Zagrebu, Zagreb.
- Migotti, B., Šlaus, M., Dukat, Z., Perinić, Lj. 1998, *Accede ad Certissiam: antički i ranokršćanski horizont arheološkog nalazišta Štrbinci kod Đakova*, Đakovo, Zagreb.
- Nagy 2014, Forging Samian Ware in the Pannonian Way: the Case of Stamped Pottery. *RCRF* 43, 119-127.
- Ožanić, I. 1989, Gradina Osječenica - antičko razdoblje, *Opuscula archaeologica*, 22, 27– 80. <https://hrcak.srce.hr/5460>
- Ožanić, I. 2004, *Tipologija rimske keramike iz Vinkovaca*, Magistarski rad, Sveučilište u Zagrebu.
- Ožanić Roguljić, I. 2016, *Tipologija rimske keramike iz Vinkovaca*, Monographiae Instituti archaeologici, 10, Zagreb.
- Ožanić Roguljić, I., Konestra, A. 2017, Pannonian slipped ware in Dalmatia, *Zbornik III. međunarodnog arheološkog kolokvija. Rimske keramičarske i staklarske radionice. Proizvodnja i trgovina na jadranskom prostoru. 4. - 5. studenoga 2014* (eds.) Lipovac Vrkljan, G. et all., Zagreb Crikvenica : Institut za arheologiju, 2017, 453-460.
- Pavić, I. 2004, Zum Formenspektrum der pannonischen Glanztonkeramik von Wien 1, Michaelerplatz – Grabungen 1990/91, Fundort Wien. *Berichte zur Archäologie*, 7.2004 118-166
- Plesničar-Gec, Lj. 1977, *Keramika Emonskih nekropol*, Dissertationes et monographiae 20 Ljubljana.
- Roksandić, D. 2018, *Vinkovci u kasnorimskom razdoblju*, Vinkovci.
- Tkalčec, T., Karavanić, S., Šiljeg, B., Jelinčić, K. 2007, Novootkrivena arheološka nalazišta uz rječju Veliku kod mjesta Majur i Ladinec, *Cris*, IX, 5-25. <https://hrcak.srce.hr/20174>
- Vidošević, I. 2003, Rimska keramika s lokaliteta Starčevićeve ulice 37 u Sisku, *Godišnjak Gradskog muzeja u Sisku*, sv. III-IV, Sisak, 11–74.
- Vikić-Belančić, Gorenc, 1958, Arheološka istraživanja antiknog kupališta u Varaždinskim Toplicama od 1953.-1955. godine, *Vjesnik Arheološkog muzeja u Zagrebu*, 3.s.c vol. I, Zareb, 76-127. <https://hrcak.srce.hr/20198>
- Vikić-Belančić, B. 1965, Neka obilježja ranocarske keramike u jugozapadnoj Panoniji, Quelques caracteristiques de la ceramique du Haut Empire dans la Pannonie du Sud-Ouest. *Starinar*, n.s. XIII-XIV, 1962-1963, Beograd, 89–112.
- Vikić-Belančić, B. 1971, Karakter rimske keramike

- južne Panonije i problematika njene tipologije i kronologije, *Materijali*, VIII, Zenica, 91–110.
- Wiewegh, Z. 2001, Rimska kovnica iz Siska s lokaliteta «Kovnica», *Opuscula Archaeologica*, 25, 98–149. <https://hrcak.srce.hr/clanak/8680>
- Wiewegh, Z. 2003, *Jugoistočna nekropola Siscije*, Sisak.
- Šimić, J., Filipović, S. 1997, *Kelti i Rimljani na području Osijeka*, Osijek.
- Škoberne, V., Košćević, R., Makjanić, R. 1987, *Drenje*, Brdovec.
- Škiljan, I. 2019, *Tajne između Ivanščice i Medvednice*, Gornja Stubica.
- Zaštitna arheološka istraživanja Gradskog muzeja Sisak 2000.-2010. Archaeological conservation research of the City Museum Sisak since 2000. until 2010., katalog izložbe, Sisak, 2011.

CROATIAN BIBLIOGRAPHY ON PSW

- Andrašić, I. 2020, *Rimska stolna keramika s nalazišta Sveti Martin na Muri* (Halicanum) – istraživanja od 2015. do 2018.godine, Diplomski rad, Sveučilište u Zagrebu, Filozofski fakultet, Zagreb, <https://urn.nsk.hr/urn:nbn:hr:131:977291> (datum preuzimanja:2021-01-21)
- Bekić, L., Višnjić, J. 2008, Južni dio antičke nekropole na položaju Sv. Marko - Baška, Summary: Southern part of the roman necropolis on the Sv.Marko - Baška site, *Vjesnik Arheološkog muzeja u Zagrebu*, Vol. XLI, 209–258. <https://hrcak.srce.hr/46217>
- Borzić, I., Čelhar, M., Gusar, K., Ilkić, M., Radović, M., Vujević, D. 2013, Arheološka istraživanja okoliša crkve sv. Križa u Ninu. Katalog izložbe povodom 50. obljetnice Odjela za arheologiju Sveučilišta u Zadru, Zadar.
- Brukner, O. 1981, *Rimska keramika u jugoslavenskom delu provincije Donje Panonije*, Beograd.
- Demo, Ž. 1982, Rezultati arheoloških iskopavanja ranocarske nekropole u Kunovec Bregu kraj Koprivnice (iskopavanja u 1979. i 1980. godini)“, *Podravski zbornik* '82, Koprivnica, 279–327.
- Dobrev, D., Mantovani, V. 2017, Ceramiche fini di produzione dalmata, retica e di Treviri ad Aquilea, *Zbornik III. međunarodnog arheološkog kolokvija. Rimske keramičarske i staklarske radionice. Proizvodnja i trgovina na jadranskom prostoru. 4. - 5. studenoga 2014.* Lipovac Vrkljan, Goranka et al. (ur.), 225-224.
- Gregl, Z. 1989, *Zagreb – Stenjevec*, Zagreb.
- Gregl, Z. 1997, *Rimske nekropole sjeverne Hrvatske*, Zagreb.
- Gregl, Z. 2009, O importu panonske keramike ukrašavane pečatima u Dalmaciju, *Jurišičev zbornik*, Zagreb, 198–205.
- Gregl, Z. 2007, *Rimskodobna nekropola Gornja Vas na Žumberku*, Zagreb.
- Gregl, Z., Jelinčić, K. 2010, O nekim manje poznatim antičkim lokalitetima u Zagrebu i okolici, *Vjesnik Arheološkog muzeja u Zagrebu*, Vol. XLIII, 151-191. <https://hrcak.srce.hr/74573>
- Iskra – Janošić, I. 1995, Zaštitna arheološka istraživanja u 1994. godini, *Godišnjak Ogranka Matice hrvatske Vinkovci*, 12, Vinkovci, 125 -131.
- Iskra – Janošić, I. 2001, *Urbanizacija Cibala i razvoj keramičarskih središta*, Vinkovci.
- Jelinčić, K. 2008, Probno arheološko istraživanje u Orešcu 2007, *Annales Instituti archaeologici*, IV, 40-43. <https://hrcak.srce.hr/file/54090>
- Jelinčić, K. 2009, Rimska keramika lokalne proizvodnje na području hrvatskog dijela rimske provincije Gornje Panonije, Doktorska disertacija, Sveučilište u Zagrebu.
- Jelinčić, K. 2012, Ceramica Romana tardo antica dal villaggio Romano Virovitica Kiškoriya jug (*Pannonia Superior*) dalle unità stratigrafiche datate mediante ¹⁴C, *Rei Cretariae Romanae Favtorvm, Acta* 42, 69-79.
- Jelinčić Vučković, K. 2011, Roman Pottery Finds from Ilok – Castle of the Dukes of Ilok Site Excavations (2001-2004), *EMAC 2011 11th European Meeting on Ancient Ceramics, Poster presentation.* https://www.academia.edu/6111965/Roman_Pottery_Finds_from_Ilok_Castle_of_the_Dukes_of_Ilok_Site_Excavations_2001_2004
- Jelinčić Vučković, K. 2012, *Stručno izvješće o rimskoj keramici iz Ludbrega (iskopavanja 2008.-2011.g.)*, elaborat, arhiva IARH.
- Jelinčić Vučković, K. 2013, Rimska keramika s lokaliteta Petrovac, *Prilozi Instituta za arheologiju u Zagrebu*, Vol. 30, 157-171. <https://hrcak.srce.hr/clanak/165130>
- Jelinčić, K. 2015, *Rimsko selo u provinciji Gornjoj Panoniji: Virovitica Kiškoriya Jug.* Monographiae Instituti Archaeologici 7, Zagreb.
- Karavanić, S., Kudelić, A. 2013, Rezultati arheoloških istraživanja lokaliteta Kalnik-Igrišće, *Annales Instituti Archaeologici*, Vol. IX, 88-92. <https://hrcak.srce.hr/112040>
- Leleković, T. 2018, How were Imitations of Samian Formed? *Internet Archaeology*, 50 1; 18. <https://doi.org/10.11141/ia.50.18S>
- Migotti, B., Šlaus, M., Dukat, Z., Perinić, Lj. 1998, *Accede ad Certissiam: antički i ranokršćanski horizont arheološkog nalazišta Štrbinci kod Đakova*, Đakovo, Zagreb.
- Miletić Čakširan I. 2019, *Tipološko kronološka klasifikacija rimske keramike iz Siscije*, doktorska disertacija, Filozofski fakultet u Zagrebu, Zagreb.
- Ožanić, I. 1998, Gradina Osječenica - antičko razdoblje, *Opuscula archaeologica*, 22, 27– 80. <https://hrcak.srce.hr/5460>
- Ožanić, I. 2004, *Tipologija rimske keramike iz Vinkovaca*, Magistarski rad, Sveučilište u Zagrebu.
- Ožanić Roguljić, I. 2009, Rimski nalazi s lokaliteta Liskovac -Južna obilaznica Vinkovaca, *Prilozi Instituta za arheologiju u Zagrebu*, Vol. 26. 79–142. <https://hrcak.srce.hr/50495>
- Ožanić Roguljić, I. 2016, *Tipologija rimske keramike iz*

- Vinkovaca*, Monographiae Instituti archaeologici, 10, Zagreb.
- Ožanić Roguljić, I., Konestra, A. 2017, Pannonian slipped ware in Dalmatia, *Zbornik III. međunarodnog arheološkog kolokvija. Rimske keramičarske i staklarske radionice. Proizvodnja i trgovina na jadranskom prostoru. 4. - 5. studenoga 2014* (eds.) Lipovac Vrkljan, G. et all., Zagreb Crikvenica : Institut za arheologiju, 2017, 453-460.
- Ožanić Roguljić, I.; Kolak, T. Excavations of the Roman Sites in Lika (Croatia): Žuta Lokva, Lički Ribnik, New Discoveries between the Alps and the Black Sea Results from the Roman Sites in the Period between 2005 and 2015 Proceedings of the 1st International Archaeological Conference, Ptuj, Janežič, M. (ed.) 115-125
- Pavišić, I. 1983, Prilog poznavanju importa u antičkom Fulfinumu, *Prilozi Instituta za arheologiju u Zagrebu*, Vol.1, 39–50. <https://hrcak.srce.hr/en/25793>
- Roksandić, D. 2018, *Vinkovci u kasnorimskom razdoblju*, Vinkovci.
- Tkalčec, T., Karavanić, S., Šiljeg, B., Jelinčić, K. 2007, Novootkrivena arheološka nalazišta uz rječcu Veliku kod mjesta Majur i Ladinec, *Cris*, IX, 5-25. <https://hrcak.srce.hr/en/20174>
- Topić, M. 2002, Stolno posuđe i glinene svjetiljke iz Augusteuma Narone, *Vjesnik za arheologiju i historiju dalmatinsku*, 95, 183–344. <https://hrcak.srce.hr/en/198831>
- Vidošević, I. 2003, Rimska keramika s lokaliteta Starčevićeve ulice 37 u Sisku, *Godišnjak Gradskog muzeja u Sisku*, sv. III-IV, Sisak, 11–74.
- Vikić–Belančić, B. 1965, Neka obilježja ranocarske keramike u jugozapadnoj Panoniji, Quelques caractéristiques de la ceramique du Haut Empire dans la Pannonie du Sud-Ouest. *Starinar*, n.s. XIII-XIV, 1962-1963, Beograd, 89–112.
- Vrdoljak, S., Kudelić, A. 2019, *Kalnik-Igrišće, Naselje kasnog brončanog doba*, Monographiae Instituti archaeologici, XIV, Zagreb.
- Wiewegh, Z. 2001, Rimska kovnica iz Siska s lokaliteta «Kovnica», *Opuscula Archaeologica*, 25, 98–149. <https://hrcak.srce.hr/en/5540>
- Wiewegh, Z. 2003, *Jugoistočna nekropola Siscije*, Sisak.
- Šimić, J., Filipović, S. 1997, *Kelti i Rimljani na području Osijeka*, Osijek.
- Škoberne, V., Košćević, R., Makjanić, R. 1987, *Drenje*, Brdovec.
- Škiljan, I. *Tajne između Ivanšćice i Medvednice*, Stubica, 2019.
- Zaštitna arheološka istraživanja Gradskog muzeja Sisak 2000.-2010.* Archaeological conservation research of the City Museum Sisak since 2000. until 2010., katalog izložbe, Sisak, 2011.

INTERNET SOURCES

<https://www2.rgzm.de/Transformation/Magyarország/Glanztonware/GlanztonwareEnglisch.htm>
(consulted 20 January 2021)

SAŽETAK

UVOD U PANONSKU KERAMIKU S PREMAZOM U HRVATSKOJ

Cljučne riječi: južna Panonija, panonska keramika s premazom, rimska keramika

U ovom radu dajemo kratak pregled oblika koji se javljaju u Južnoj Panoniji i predlažemo podjelu proizvodnje na dva područja: jugozapadnu i jugoistočnu skupinu panonske keramike s premazom (PSW). Popisani su lokaliteti (karta 1; table 1a i 1b) na kojima se nalazi PSW kako bi se prikazala rasprostranjenost ove vrste keramike u hrvatskom dijelu južne Panonije. Glavna ideja rada je pokazati značaj u regiji i stvoriti polazišnu točku iz koje se može napraviti opsežnija studija.

Type	Description	Fabric from publication	Site
	<p>Bowl, recalling the shape of Drag 37</p>	<p>gray, fine grayish slip</p> <p>red, fine, reddish slip</p> <p>gray, fabric with inclusions</p>	<p>Gornja vas Stenjevec</p>
	<p>Hemispherical bowl with profiled rim</p>	<p>red, fine</p>	<p>Gornja vas</p>

Plate 1 Types of bowls South – western group (Made by M. Korić and I. Ožanić Roguljić from Gregl 2007)

Type	Description	Fabric from publication	Site
	Hemispherical bowl with groove under the rim	red, fine	Gornja Vas
	Hemispherical bowl with rounded profile on the inside of the rim	dark gray, fine	Gornja Vas
	Hemispherical bowl	gray, fine black slip	Gornja Vas Stenjenvec

Plate 2 Types of bowls South – western group (Made by M. Korić and I. Ožanić Roguljić from Gregl 2007)

Type	Description	Fabric from publication	Site
	Bowl with light S profilation	red, soft	Gornja Vas
	Bowl recalling Drag 44	red, fine, reddish slip gray, fine, grayish slip	Gornja Vas

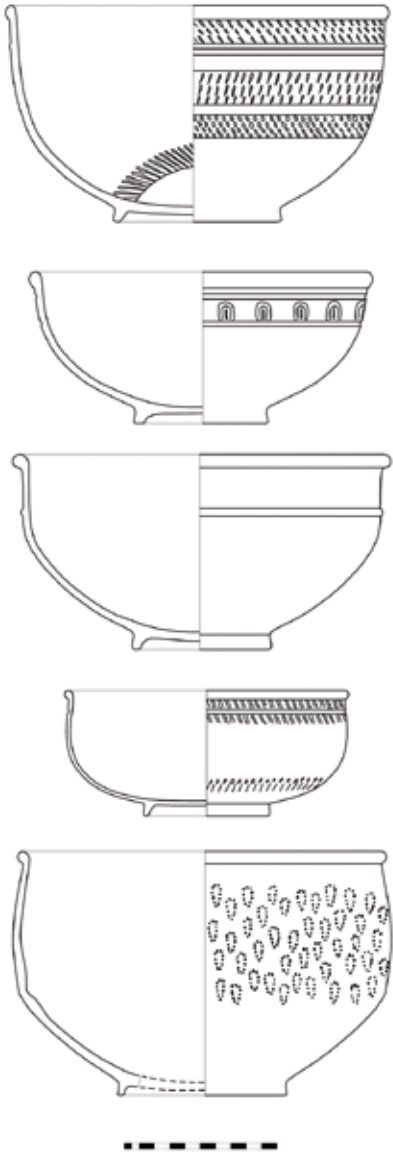
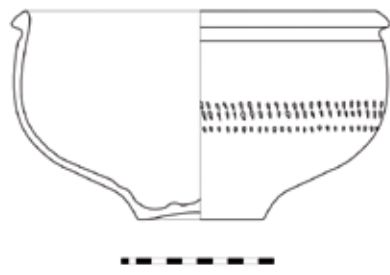
Plate 3 Types of bowls South – western group (Made by M. Korić and I. Ožanić Roguljić from Gregl 2007)

Type	Description	Fabric from publication	Site
	<p>Plate with curved rim</p>	<p>gray, fine grayish slip</p> <p>red, fine, reddish slip</p>	<p>Gornja Vas Stenjevec</p>
	<p>Plate with spread out rim</p>	<p>gray, fine</p>	<p>Stenjevec</p>
	<p>Variants of plates with flat bottom</p>	<p>red, reddish slip</p>	<p>Gornja Vas Stenjevec</p>

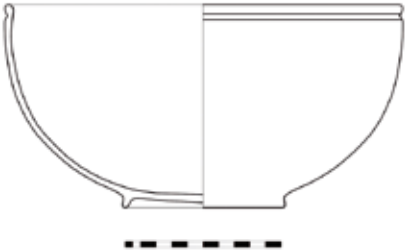
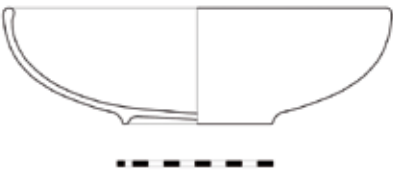
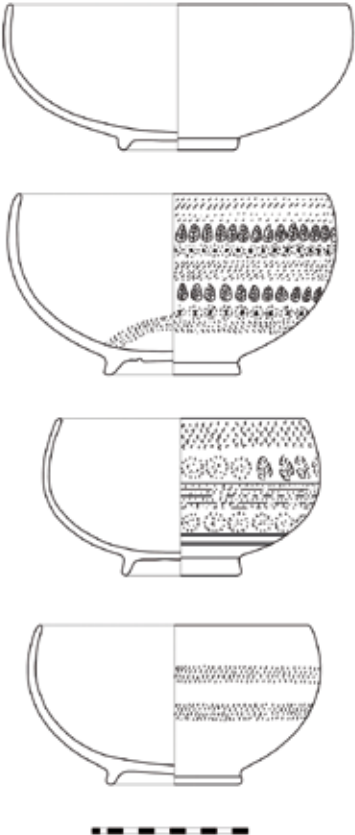
Plate 4 Types of plates South – western group (Made by M. Korić and I. Ožanić Roguljić from Gregl 2007)

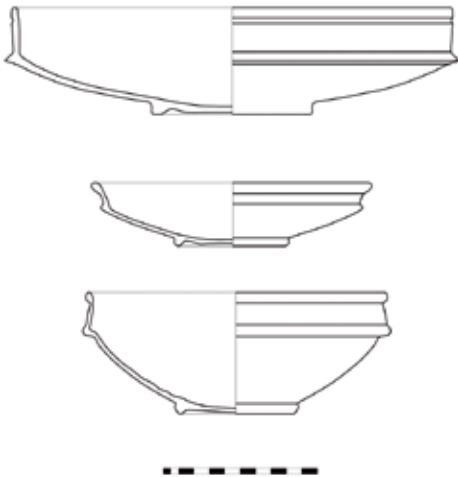

Type	Description	Fabric from publication	Site
	Bowl, recalling the shape of Drag 37	gray, fine grayish slip red, fine, reddish slip orange, fine, light red slip strokes of brush is visible	Osječenica
	Bowl with almond-shaped rim	orange light red slip white decoration	Osječenica
	Bowl, recalling the shape Ritt 9	gray, soft, without inclusions, shiny brownish black slip, visible strokes of the brush	Osječenica

Plate 5 Types of bowls – Osječenica (Made by M. Korić and I. Ožanić Roguljić from Ožanić 1998)

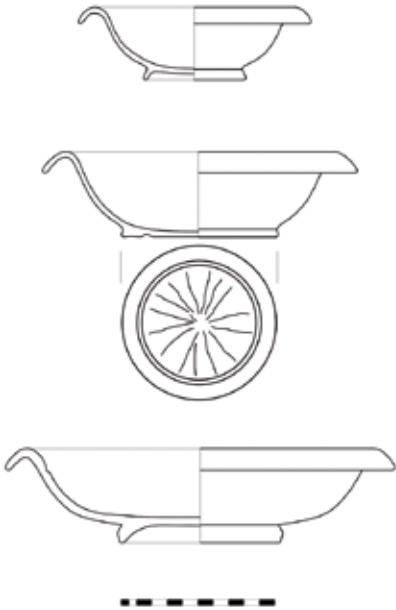
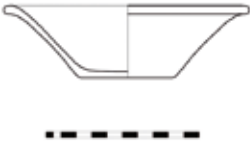
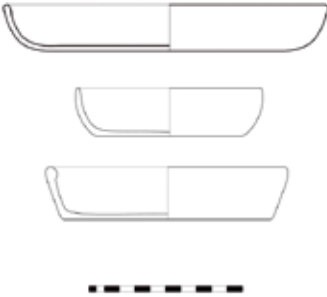

Type	Description	Fabric from publication	Site
	<p>Bowl with widened inward-bend rim</p>	<p>gray, soft, without inclusions, Slip is shiny, with visible strokes of a brush</p>	<p>Osječenica</p>
	<p>Bowl with inward-bend rim</p>	<p>reddish, soft, with inclusions black slip</p>	<p>Osječenica</p>

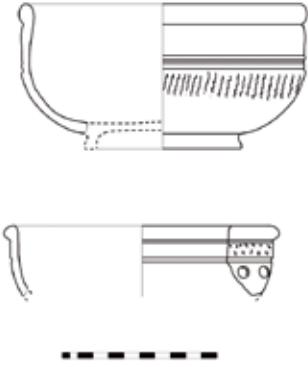
Plate 6 Types of bowls – Osječenica (Made by M. Korić and I. Ožanić Roguljić from Ožanić 1998)

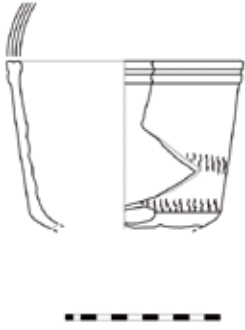





Type	Description	Fabric from publication	Site
 <p>Z 1/B 1</p>	Bowl recalling Drag 18/31 2nd-3rd CE	red 1	Vinkovci
 <p>Z 2/B 2</p>	Bowl recalling Drag 32 2nd-3rd CE	gray 2	Vinkovci
 <p>Z 3.1/ B 3.1</p> <p>Z 3.2/B 3.2</p>	Bowl recalling Drage 35 2nd-3rd CE	gray 1, 3 red 1	Vinkovci
 <p>Z 4/ B 4</p>	Small bowl with curved rim 3rd CE	gray 3	Vinkovci
 <p>Z 5/ B 5</p>	Bowl recalling Drag 37 2nd-4th CE	gray 1, 5 red 2	Vinkovci
 <p>Z 6/ B 6</p>	Bowl recalling Dragendorf 37 2nd-4th CE	gray 1, 5	Vinkovci

Plate 7 Types of bowls South – eastern group (Made by I. Ožanić Roguljić from Ožanić Roguljić 2016)



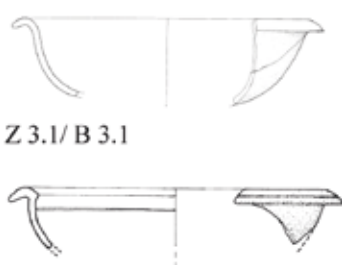

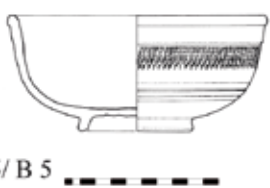

Type	Description	Fabric from publication	Site
 <p>Z 7/ B 7</p>	Bowl recalling Drag 44 Second half of the 1st-3rd CE	gray 3 red 2	Vinkovci
 <p>Z 8/ B 8</p>	Bowl recalling Curle 11 2nd- beginning 3rd CE	red 2	Vinkovci
 <p>Z 9/ B 9</p>	Hemispherical bowl with profiled slightly beveled rim 2nd-3rd CE	red 3	Vinkovci
 <p>Z 10/ B 10</p>	Bowl recalling Drag 24/25 end 1st CE - 2nd CE	red 10	Vinkovci
 <p>Z 11/ B 11</p>	Biconical bowl with profiled rim 3rd CE	gray 11	Vinkovci
	Bowl recalling Drag 51 2nd-3rd CE	brownish red clay with orange slip	Vinkovci
	Bowl recalling Curle 15 2nd-3rd CE	brownish red clay with orange slip	Osijek Vukovar

Plate 8 Types of bowls South – eastern group (Made by I. Ožanić Roguljić from Ožanić Roguljić 2016)

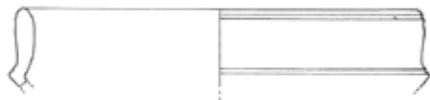

Type	Description	Fabric from publication	Site
 <p>T 7/P 7</p>	<p>Plate recalling Drag 36 2nd CE</p>	<p>gray 1, 2, 3 red 1</p>	<p>Vinkovci</p>
 <p>T 8/P 8</p>	<p>Plate with slightly beveled and curved rim 2nd-mid 3rd CE</p>	<p>gray 1</p>	<p>Vinkovci</p>
 <p>T 9/P 9</p>	<p>Plate with ringed bottom twice stamped leaf ornament 2nd CE</p>	<p>gray 2</p>	<p>Vinkovci</p>
 <p>T 10/P 10</p>	<p>Slightly curved walls and straight rim end 1st - mid 2nd CE</p>	<p>gray 3</p>	<p>Vinkovci</p>

Plate 9 Types of plates South – eastern group (Made by I. Ožanić Roguljić from Ožanić Roguljić 2016; Brukner 1981)





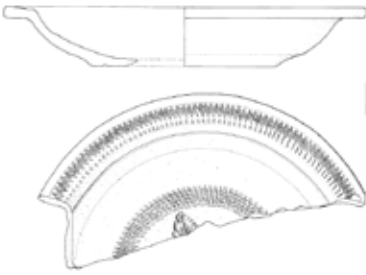

Type	Description	Fabric from publication	Site
 <p>T 1/Pl 1</p>  <p>T 2/Pl 1</p>  <p>T 3/Pl 3</p>  <p>T 4/Pl 4</p>  <p>T 5/Pl 5</p> <p>-----</p>	<p>Plates with flat bottom 2nd-3rd CE</p>	<p>red 2,3</p>	<p>Vinkovci</p>
 <p>T 6/Pl 6</p> <p>-----</p>	<p>Plates with flat bottom 4th CE</p>	<p>red 3</p>	<p>Vinkovci</p>

Plate 10 Types of plates South – eastern group (Made by I. Ožanić Roguljić from Ožanić Roguljić 2016)

Type	Description	Fabric from publication	Site
 <p data-bbox="204 580 363 607">PVR 1/VMH 1</p>	<p data-bbox="730 323 932 384">Pot with two handles 2nd CE</p>	<p data-bbox="1031 318 1082 345">red 1</p>	<p data-bbox="1246 307 1329 334">Vinkovci</p>
 <p data-bbox="220 1443 339 1469">PR 1/VG 1</p>	<p data-bbox="730 788 884 849">Vessel with grid 2nd CE</p>	<p data-bbox="1031 784 1082 810">red 1</p>	<p data-bbox="1246 770 1329 797">Vinkovci</p>

Plate 11 Other forms South – eastern group (Made by I. Ožanić Roguljić from Ožanić Roguljić 2016)

PANNONIAN SLIPPED WARE FROM SISAK

Pannonian slipped ware from Sisak was not processed in bulk, but some examples from the collection of the Archaeological Museum in Zagreb and the City Museum in Sisak were published. Based on the analysis of a very small sample of 84 examples of Pannonian slip ware published so far, it was determined that seven different textures appear in Siscia and that the pottery was fired using oxidation and reduction techniques with grey, black and red coating. The coating can be glossy, glossy metallic and matte. Ten types of cups (PANNON. C. TYPE 1–10), four types of plates (PANNON. P. TYPE 1–4) and ten types of bowls (PANNON. B. TYPE 1–10) were singled out typologically. An analysis of the stamped decorations revealed that Pannonian slipped ware of the southern Pannonian and western Pannonian groups appears in Siscia. Some examples of poor workmanship could indicate that this type of pottery was produced locally i.e. in Siscia. It appears in the 2nd century, during the period of prosperity since Trajan's rule up to the end of the 2nd and the beginning of the 3rd century, and sporadically even later.

Keywords: Pannonian slip ware, ger. Pannonische Glanztonware, Siscia, typology

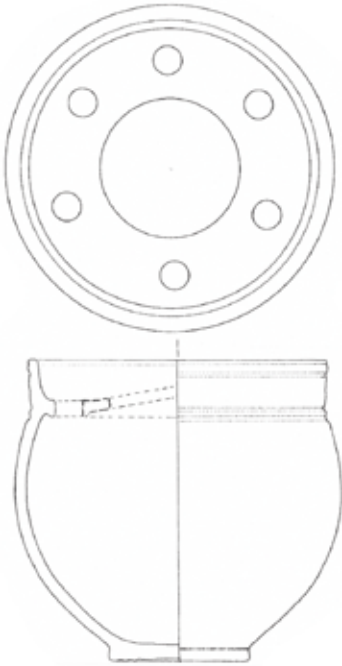
Pannonian slipped ware (ger. *Pannonische Glanztonware*¹ (PGW)) is pottery produced in several centres of Pannonia, and can be found in *Siscia*, as well. The first systematization of all published findings (Makjanić 1995: 74; Wiewegh 2003; Tomaš 2007; Baćani *et al.* 2011) alongside with processing of those found at the sites St. Quirinus and the Hist. Archive, was conducted as a part of the doctoral dissertation Typological-chronological classification of Roman pottery from *Siscia* (Miletić Čakširan 2019). The processed examples were found inside the ramparts and at the necropolises of *Siscia*.

Based on the analysis of a very small sample of 84 examples of Pannonian slip ware published so far, it was determined that fine tableware (bowls, plates and cups) appears in *Siscia*. The pottery was fired using oxidation and reduction techniques with grey, black and red coating. The coating can be glossy, glossy metallic and matte. Vessels are undecorated or decorated by use of a small roller or a stick and / or by stamping. Analysis of Pannonian slip ware found in the area of *Siscia* revealed seven different clay textures:

1. Gray wall colour, with grey / dark grey or very dark grey glossy coating.
The coating on some examples is metallic .
2. Gray to dark grey wall colour with black matte coating.
3. Gray wall colour with a light brown glossy coating.
4. Brown to orange-brown wall colour with dark grey to black coating.
5. Orange to red wall colour with grey to dark grey matte coating.
6. Orange wall colour with red or light red matte coating.
7. Yellow-orange to ochre wall colour with orange coating.

¹ Although the German term *pannonische glanzton ware* refers to pottery with a glossy coating, analyses indicate that products with a matte coating were also produced. The inconsistency of terms was pointed out by A. Konsetra and I. Ožanić Roguljić as well as by other authors dealing with this type of ceramic material (Konestra & Ožanić Roguljić 2014; Konestra & Ožanić Roguljić 2017; Nagy 2017). This pottery is also called Pannonian pottery, Pannonian pottery with stamped decorations, the imitation of *terra sigillata* and *terra nigra*, etc.

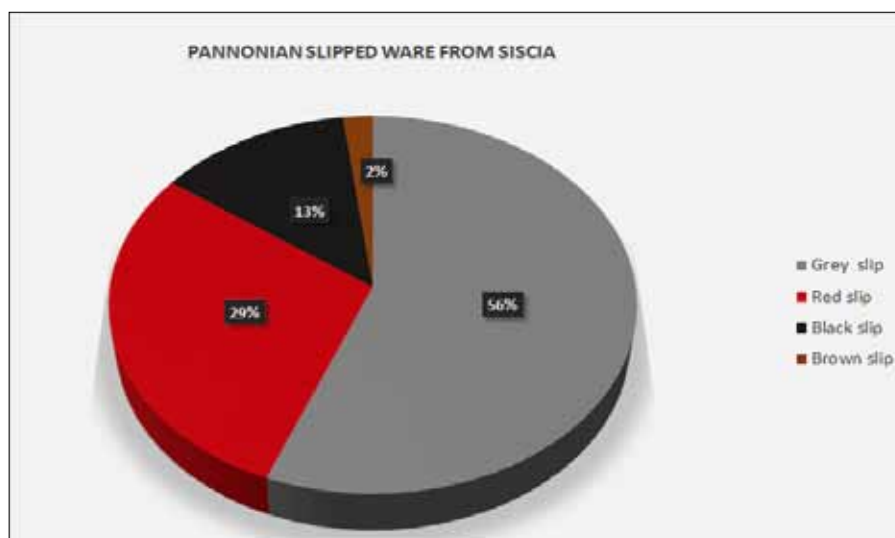

Fig. 1 Analysis of the colour of the coating of the Pannonian pottery found at the sites St. Quirinus and the Historical Archives

The analysis of the colour of the coating of the Pannonian pottery can be conducted on the processed pottery found at the sites St. Quirinus and Historical Archive. It was found that 56% of the fragments had grey to dark grey coating, and 29% had orange to red coating (Fig. 1).

Typologically, 11 types of cups (PANNON. C. TYPE 1–11), 4 types of plates (PANNON. P. TYPE 1–4) and 10 types of bowls (PANNON. B. TYPE 1–10) were singled out.

CUPS (PANNON. C. TYPE 1–11)

PANNON. C. TYPE 1

A bell-shaped cup, with a narrowed ribbed neck. The rim, triangular in cross-section, slopes on the inside and is vertical on the outside. The cup has grey walls and a dark grey glossy coating. Its diameter is 8 cm. An analogous type with red coating was found on the Osječenica hillfort (Ožanić 1998: Pl. 3: 1). This type of cup is analogous to type Be 2.1 according to Adler-Wölfel typology of the material from *Carnuntum*, dated from the end of the 1st to the 2nd century (Adler-Wölfel 2004: 50, Fig. 17; Pl. 14: 305).

PANNON. C. TYPE 2

A cup with oval body and short ribbed outwardly curved funnel-shaped rim. The cup has grey walls and a dark grey metallic coating.

PANNON. C. TYPE 3

A cup with oval body with a long funnel-shaped ribbed neck ending in an annular thickened small twisted rim. The walls are reddish brown with a dark grey coating.

PANNON. C. TYPE 4

A cup with sloping flat walls with a triangular thickened rim, sloping on the inside. The walls are orange, while the coating is dark grey. The shape bears a resemblance to the cup from *Carnuntum* type Be 6.1 dated to the 2nd century (Adler-Wölfel 2004: 51, fig. 17, Pl. 14: 311).

PANNON. C. TYPE 5

A cup with a spherical body, a short-tapered neck and a small rim slightly thickened and curved outwards. The cup is undecorated, and it has grey metallic coating.

PANNON. C. TYPE 6

A cup with elongated oval body, slightly tapered towards the triangular rim. The walls are grey with a dark grey surface. The cup is undecorated.

PANNON. C. TYPE 7

A cup with oval body, a longer straight and tapered neck and an outwardly curved rim. The transition from the neck to the body is decorated with a rib. An analogous cup was found at the Osječenica hillfort (Ožanić 1998: Pl. 3: 5).

PANNON. C. TYPE 8

A cup with rounded enlarged body with a sharp transition into a long bell-shaped neck ending in a wide annular slightly outwardly curved rim. The cup is decorated with notches made by a small roller and strips that form several rows of short vertical notches. It has the shape of a small jug.

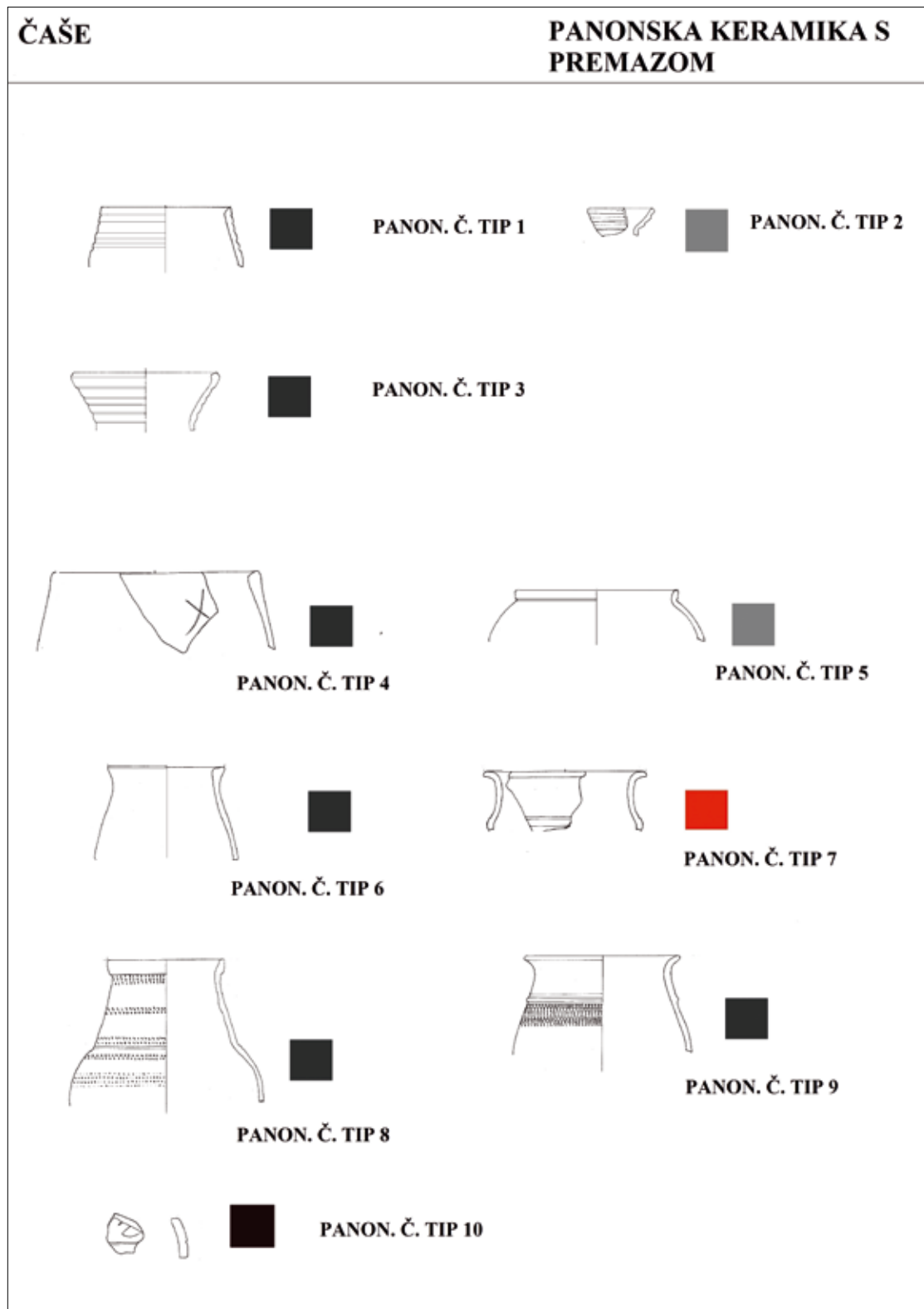

Fig 2 Cups, Pannonian slipped ware

PANNON. C. TYPE 9

A cup with oval elongated body, tapered neck and oblique outwardly curved rounded rim. At the transition from the neck to the body the decoration is made by notches made by a small roller in strips formed by several rows of short vertical notches. The cup is analogous to the type of goblet-cup from Aquinas, from a group of Eastern Pannonian pottery isolated within rare forms (Nagy 2017: Fig. 3:13).

PANNON. C. TYPE 10

A cup with decoration made by engraving ("cut glass" technique used to decorate glass vessels). The cup has analogies in fragments found in Carnuntum. Adler-Wöfl calls them type Be 5.0 and dates them to the 2nd century (Adler-Wöfl 2004: 51, Pl. 14, cat. 310). They were also found in Aquinas in the group of Resatus, type 28 from Lágymányos, dated to the 2nd - 3rd centuries (Nagy 2017: 226, Fig. 5: 5, Fig. 31: 28).

The cups are decorated with notches made by a small roller in strips and with engraving.

PLATES (PANNON. P. TYPE 1-4)

PANNON. P. TYPE 1

A Drag. 36 (Consp. 39) shaped plate, with rounded walls, a low annular foot and a curved rounded rim. It has dark grey-black or red coating. At the position of the Hist. Archive, a Drag 36 shaped plate with rounded walls and a thickened curved rim decorated along its entire width with regular incisions made by a small roller, was found. It has analogies with type Te 2.4 according to the Adler-Wöfl's typology of material from Carnuntum (Adler-Wöfl 2004: 33, Pl. 1: Cat. 2-18). This type, modelled on *terra sigillata*, has a stamped ornament at the centre of the inside of the plate. It dates back to the 2nd century.

PANNON. P. TYPE 2

A plate with rounded walls and widened, inward-bent curved rim. On its outside it is decorated with grooves below the rim. The walls are grey while the coating is dark grey metallic. Its diameter is 24 cm. Plates of analogous shape were found at the Osječnica hillfort (Ožanić 1998: Pl. 9: 4-7).

PANNON. P. TYPE 3

A plate with rounded walls with a widened rounded rim that has an annular thickening on its inner and on its outer side. On the outside it has a groove below the rim. The walls are grey while the coating is dark grey metallic. The diameter is 28 cm.

PANNON. P. TYPE 4

A plate with slightly rounded walls with a widened, on the outside triangular, rim. It has shallow grooves on the body. The plate has grey-green walls and a dark grey coating in a combination of matte and glossy parts.

The plates are marked with a printed decoration and a decoration made with a small roller. On type 1 plates of the Pannonian pottery with the coating from *Siscia* 7 types of stamped ornaments were recorded (Fig. 3): stamped decoration with a stylized footprint and two rosettes on each side (S 1), rosette stamp at the bottom of the vessel (S 2), stamps with different shapes of leaves (S 3-5) (Miletić Čakširan 2019: 132-140), stamped bird decoration between two leaves (S 6) (Wiewegh 2003: 49, 82; Tomaš 2007: cat. No. 39, Inv. No. 510: SIK 313 / AZA) and a stamped letter V framed in a square frame and with two circles with two leaves (S 7) (Makjanić 1996: 118, Pl. 16: 13). The decoration of stamped, differently designed leaves S3 is analogous to the printed decorations from the Salla (Zalalövő) site types 17 and 28 (Maróti 1987: Fig. 3, 4), while the decoration S4 corresponds to the decoration type 4 * according to the division of the material from Salla (Zalalövő): 96). These findings indicate that the Pannonian slipped ware from Sisak has stamped ornaments of the southern Pannonian, but also of the western Pannonian group.

BOWLS (PANNON. B. TYPE 1-10)

PANNON. B. TYPE 1

Smaller bowl with simple rounded walls and a rounded rim. It is decorated with notches made by a small roller. The bowl is analogous to type 12 of the Pannonian slipped ware according to L. Nagy (Nagy 2017: 223, Fig. 28: 12). A bowl of this design was also found in the Turopoljski Lug tumuli (Makjanić & Košćević 1986/87: Pl. XVI 164). It can be dated to second half of the 2nd century.

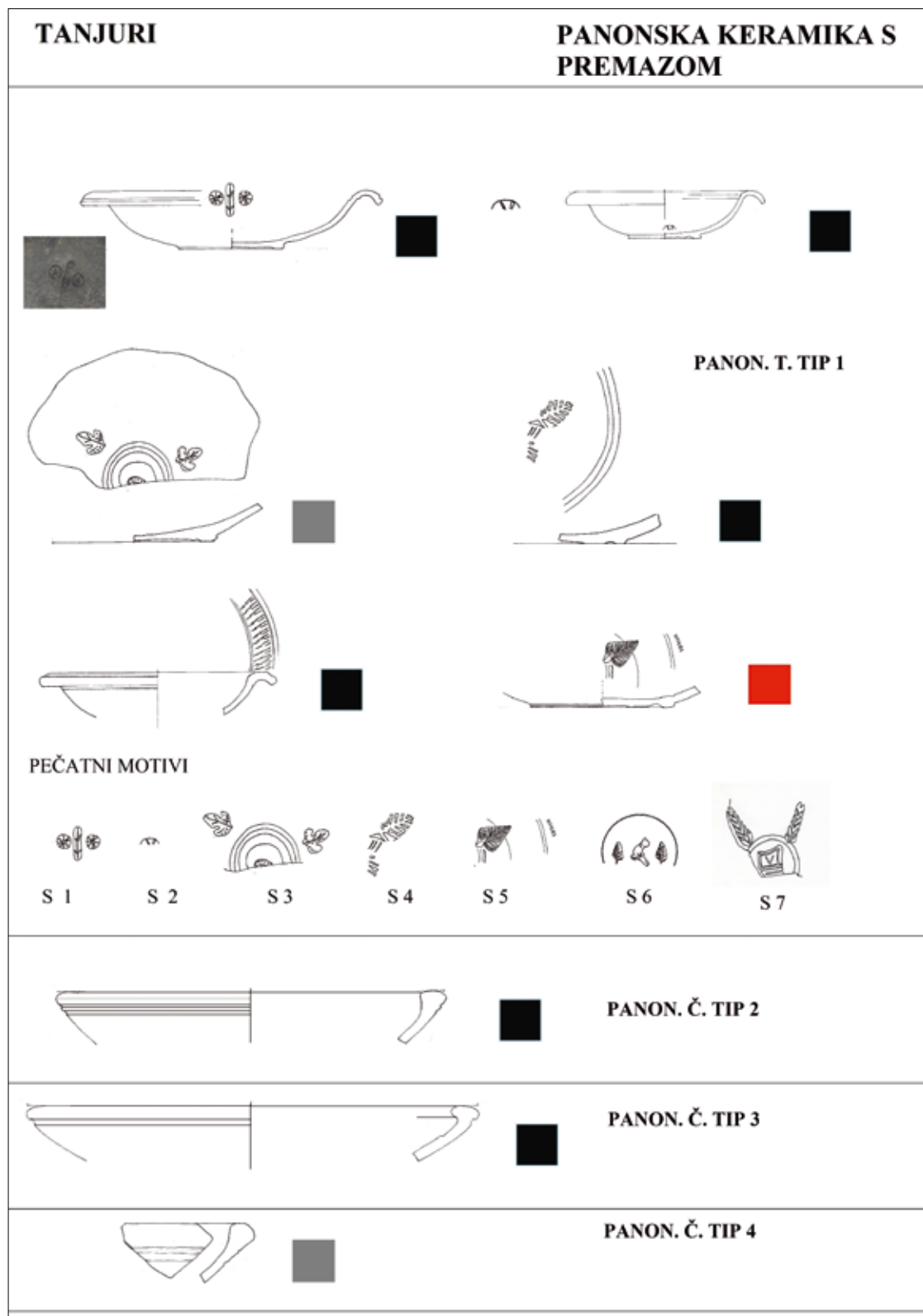

Fig. 3 Plates, Pannonian slipped ware

PANNON. B. TYPE 2

A deeper bowl with a rim profiled with two grooves and sloping on the inside, with vertical walls with a slightly accented transition to a narrowed part towards its base. The bowl has thinner walls and is of fine workmanship.

PANNON. B. TYPE 3

A deeper bowl with a trapezoidal recipient and a high annular base. The recipient has a wide rib close to the base. The rim is not preserved. The space between the rim and the rib is decorated with tiny rows of notches made by a small roller. The bowl has thinner walls and a fine matte coating.

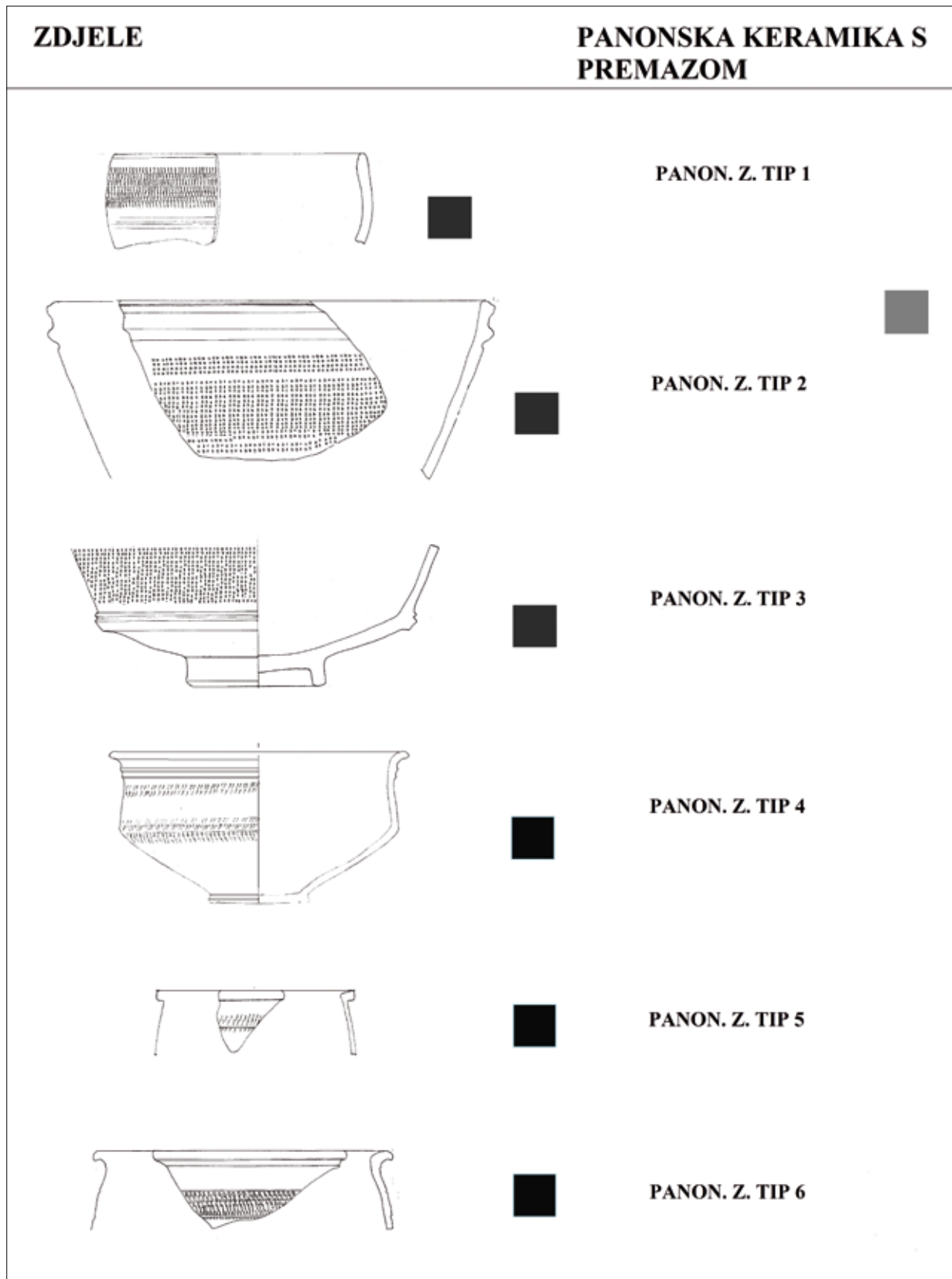

Fig. 4 Bowls, Pannonian slipped ware

PANNON. B. TYPE 4

Biconical bowl with a narrow annular base. The neck is slightly convex and has a curved annular rim. On the outside, below the rim, there are two ribs. The bowl is S-shaped, which is characteristic for the La Tène period. It is decorated with bands filled with rows of notches made by a small roller. The bowl has thinner walls and is of fine workmanship.

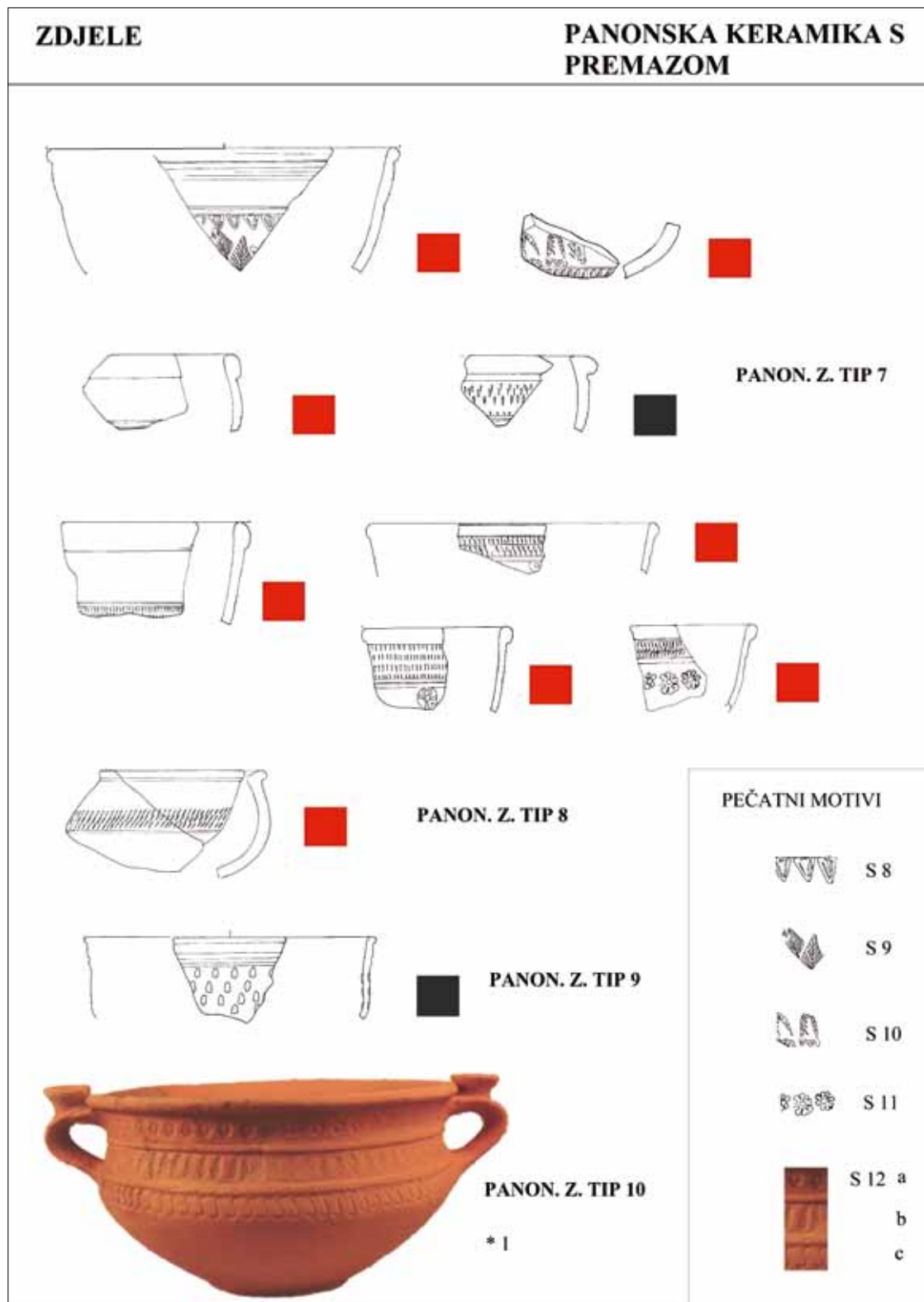

Fig. 5 Bowls, Pannonian slipped ware

PANNON. B. TYPE 5

Smaller bowl with slightly rounded body, somewhat tapered towards the curved rim with the square cross-section. Below the rim, at the upper part of the body there is a decoration made of rows of notches made by a small roller. The bowl has thinner walls and is of fine workmanship.

PANNON. B. TYPE 6

A bowl with a rounded body, narrowed neck and a curved rim. Body is, at its upper part, decorated with a series of notches made by a small roller. The bowl has thinner walls and is of fine workmanship.

PANNON. B. TYPE 7

Drag. 37 type bowl. These bowls are decorated with a combination of ornaments made by a small roller and a stamp. This form is common in Pannonia (Ožanić 1998: T. 1; Ožanić Roguljić 2016: 41, Plesničar Gec 1977: 54; Brukner 1981: 87; Adler - Wölfl 2004: 44; Nagy 2014: 119 - 127). It is analogous to type 25 according to L. Nagy (Nagy 2017: 223, Fig. 28: 25). Bowls found at the St. Quirinus site are decorated with a motif of lines combined with notches made by a small roller and stamped triangular ovules and leaves on the widest part of the body, a motif of leaves with wavy endings below which there are several rows of notches made by a small roller (Fig. 3, S 8-10) and with a rosette motif (Fig. 4, S 11).

PANNON. B. TYPE 8

A bowl with a rounded body and an oblique V-profiled rim. In the middle of the body there is a series of notches made by a small roller. It is analogous to the Sü 2.3 type bowl from *Carnuntum* according to Adler-Wölfl (Adler-Wölfl 2004: 42, Pl. 4: 106 - 107). It also has an analogy with a bowl, also red coated, found in *Singidunum* (Bojović 1977: Pl. 11: 129).

PANNON. B. TYPE 9

Bowl with vertical, slightly sloping walls and an annular rim. The lower part of the body is slightly rounded. It is very finely made, with thin walls. The shape is a variant of Drag 37. It is decorated with two ribs on the neck, just below the rim, while the body is decorated by grooves. Bowls decorated with a series of ovals („cut glass“ technique) were found in *Aquincum* (Nagy 2017: Fig. 6). The example from Sisak differs in the quality of workmanship and the shape of the bowl itself.

PANNON. B. TYPE 10

A bowl (crater?) with two profiled handles on top of the handle with an applied recipient (cup). The rim is curved outwards, decorated with a serrated ribbon. The biconical belly is, in its upper part, decorated with a stamped ornament in three horizontal rows separated from each other by a jagged ribbon. The rows are made of rosettes, followed by leaves and a series of S-shaped motifs (Figs. 4, S 12). The bowl has orange walls and an orange coating. The diameter of the vessel is 32 cm (Bačani et al. 2011: cat. No. 57, Inv. No. 26037). According to the method of production and decoration, this bowl-crater is included in the group of Pannonian slip ware. By the details of the cup on the handle as well as the way of the use of decorations, it can be compared to cult vessels i.e., craters with applied snakes and circular depressions on the top of the handles („snake vessels“). A similar vessel was found in the temenos area of Augusteum Narona. Indentations on the handles (cups) appear on cult vessels found in the area of the Roman Empire. They contained wine, and are associated with the cult of Mithras, Dionysus. They were found in mithraeums, necropolises and villas dated to the second half of the 2nd century (Joly et al. 2010: 183; Topić 2003: T. 104: 473). The production of cult vessels in Pannonian slip ware workshops confirms the importance of Pannonian workshops, as well. It is the proof that this type was a recognized and respected ceramic type and not an imitation of *terra sigillata*. The motif of the letter S appears on stamped pottery found in *Singidunum* dating to the second half of the 3rd century (Nikolić-Đorđević 2000: 19, type I/5). A combination of rosettes and leaves was, likewise, recorded in the finds from *Singidunum* (Nikolić-Đorđević 2000: TYPE U/82). Large vessels with stamped ornaments and these „snake“ vessels are mentioned as rare forms of the Pannonian stamped ware of the Eastern group (Nagy 2017: 7, 209, Fig. 7: 12-14).

WORKSHOPS

Pannonian slipped ware is an indicator of how local heritage and Roman pottery merged stylistically and technically to create a new ceramic form produced by local workshop centres. The shape of the vessel and the manner of the decoration depended on the skill of the local master. Products were intended for the local and newly arrived Roman population (Nagy 2017: 7-10).

The analysis of stamped ornaments revealed that Pannonian slipped ware of the southern, western, as well as of the eastern Pannonian group, appears in *Siscia*. As already mentioned, the percentage of this type of pottery is very small, so it is to be expected that the provenance of the findings will spread to other areas of Pannonian slip ware workshops. Finding of a fragment of the vessel base with the remnants of the pouring paint at the position of the Historical Archive, can point

to the Sisak workshop. Such examples have been found at other sites (Nagy 2017: 231, Fig. 37; Ožanić Roguljić²) and are considered to be a mistake in the laying of coatings during the production, which could indicate local workshops.

CIRCUMSTANCES OF THE APPEARANCE OF THE PANNONIAN SLIP WARE

During the period of prosperity in Pannonia, in the 2nd century, Pannonian workshops began to produce, among other things, the Pannonian slip ware. Local workshop centres are creating new forms based on local heritage and the Roman pottery. Being more affordable than expensive metal utensils, this pottery is intended primarily for the local population. Trajan's military activities influenced the migration of the population and the Roman army, and the consequence was the transport of various items that could have been personal property or items for trade. This is confirmed by findings of the Pannonian slipped ware. In *Siscia*, in addition to products that we assume were made in a local workshop of unknown position, samples from workshops of the southern Pannonian and western Pannonian groups were found, as well as the finding of a crater that could be associated with the products of the eastern group. Since a very small sample has been processed, it is to be expected that in the hitherto unpublished and unprocessed material there will be a much larger number of shapes as well as related ornaments that will expand the knowledge of the production and trade of these products.

IVANA MILETIĆ ČAKŠIRAN
Ministry of Culture
Directorate for the Protection of Cultural Heritage
Conservation Department in Sisak
N. Tesle 17, Sisak
ivana.miletic@min-kulture.hr

2 Ožanić Roguljić, „Panonnische Glanztonware iz Vinkovaca“, ppt, znanstveni skup Arheologija na Dunavu, 2014.

BIBLIOGRAPHY

- Adler – Wöfl K. 2004, *Pannonische Glanztonware aus dem Auxiliarkastell von Carnuntum*. Ausgrabungen der Jahre 1977- 88. Ergänzungshefte zu den Jahreshften des Österreichischen Archäologischen Institutes, Heft 7, Wien.
- Baćani I., Škrgulja R. & Tomaš-Barišić T., *Zaštitna arheološka istraživanja Gradskog muzeja, Sisak 2000.-2010.* (katalog izložbe / exhibition catalogue), Sisak, 2011.
- Brukner O. 1981, *Rimska keramika u jugoslavenskom delu provincije Donje Panonije*, Dissertationes et Monographiae XXIV, Beograd.
- Bojović D. 1977, *Rimska keramika Singidunuma*, Muzej grada Beograda, 1977.
- Joly D. et al., 2010, „L'attirail d'un magicien rangé dans une Cave de Chartres/Autricum“, *Gallia* 67-2, 125-208.
- Konestra A. & Ožanić Roguljić I. 2014, „Panonska keramika u rimskodobnoj Dalmaciji, III. međunarodni arheološki kolokvij: „Rimske keramičarske i staklarske radionice. Proizvodnja i trgovina jadranskim prostorom“, izlaganje, Crikvenica 04.- 05. 11. 2014.
- Konestra A. & Ožanić Roguljić I. 2017, „Panonska keramika u rimskodobnoj Dalmaciji, Zbornik III. međunarodnog arheološkog kolokvija: „Rimske keramičarske i staklarske radionice. Proizvodnja i trgovina jadranskim prostorom“, Crikvenica, 453-463.
- Makjanić R., *Terra sigillata*, u: *Siscia, Pannonia Superior*, BAR International Series 621, Oxford, 1995.
- Košćević R. & Makjanić R. 1986/7, „Antički tumuli kod Velike Gorice i nova opažanja o panonskoj radionici glazirane keramike, *Prilozi Instituta za arheologiju* 3-4; 25-70.
- Maróti É. 1987, „Pecsételt római kerámia Zalalövöröl“, *Zalai Gyűjtemény* 26, 21-36.
- Miletić Čakširan I. 2019, Tipološko kronološka klasifikacija rimske keramike iz Siscije, disertacija, Filozofski fakultet u Zagrebu.
- Nagy A. 2014, Forging Samian Ware in the Pannonian Way: the Case of Stamped Pottery, *Rei Cretariae Romanae Favtorvm Acta* 43, 119-127.
- Nagy A. 2017, *Resatus and the stamped pottery*, Aquincum Studies 1, Budapest, 2017.
- Nikolić Đorđević S. 2000, *Antička keramika Singidunuma*, u: Singidunum 2, Beograd, 11- 245.
- Ožanić I. 1998, „Gradina Osječenica – antičko razdoblje“, *Opuscula archaeologica*, 22, 27- 80.
- Ožanić Roguljić I. 2014, „Panonsische Glanztonware iz Vinkovaca“, ppt, znanstveni skup Arheologija na Dunavu.
- Ožanić Roguljić I., „Tableware from Žuta Lokva, Roman Dalmatia (Croatia)“, PP prezentacija, *Big Data on the Roman Table, Workshop 2 of the AHRC Research Network, University of Exeter*, 2016.
- Plesničar-Gec Lj. 1977, *Keramika emonskih nekropol*, Dissertationes et monographiae XX, Mestni muzej, Ljubljana.
- Tomaš T. 2007, *Kuhanje i blagovanje u rimskoj Sisciji*, (katalog izložbe / exhibition catalogue), Sisak, 2007.
- Topić M. 2003, Posuđe za svakodnevnu upotrebu, posuđe iz Augusteuma Narone, *Vjesnik za arheologiju i historiju dalmatinsku* 96, Split, 303-515.
- Wiewegh Z. 2003, *Jugoistočna nekropola Siscije*, Gradski muzej Sisak, Sisak.

SAŽETAK

PANONSKA KERAMIKA S PREMAZOM IZ SISCIIJE

Ključne riječi: panonska keramika s premazom, Siscija, *Siscia*, tipologija

Panonska keramika s premazom iz Siska nije skupno obrađivana već su objavljeni pojedini primjeri iz zbirke Arheološkog muzeja u Zagrebu i Gradskog muzeja u Sisku. Na temelju analize vrlo malog uzorka, do sada 84 objavljena primjera, panonske keramike s premazom utvrđeno da se u Sisciji pojavljuje 7 različitih faktura, keramika je pečena oksidacijski i redukcijski sa sivim, crnim i crvenim premazom. Premaz može biti sjajan, sjajan metalnog sjaja i mat. Tipološki je izdvojeno 10 tipova čaša (PANON. Č. TIP 1-10), 4 tipa tanjura (PANON. T. TIP 1-4) te 10 tipova zdjela (PANON. Z. TIP 1-10). Analizom pečatnih ukrasa utvrđeno je kako se u Sisciji pojavljuje panonska keramika s premazom južno panonske, ali i zapadno panonske skupine. Pojedini primjeri loše izvedbe mogli bi upućivati kako se ova vrsta keramike proizvodila lokalno u Sisciji. Pojavljuje se u 2. stoljeću u razdoblju prosperiteta od Trajanove do kraja 2. i poč. 3. st., sporadično i kasnije.

POTTERY WITH *VERUS RE* STAMP FROM SVETI MARTIN NA MURI

In 2016, during the systematic archeological investigation carried out by the Croatian Conservation Institute (which lasted from 2015 to 2018), the archeologists found a base of Pannonian grayware (Pannonische Glanztonware) with an inscription. This paper will foreground the issues that arose during the analysis of the VERUS RE inscription. The stamps seems to have been imprinted on two occasions, and can be dated to a period from the end of the 2nd to the beginning of the 3rd century AD. Together with numerous discoveries of terra sigillata and functional kitchen ceramics, this is a rare discovery in Sveti Martin na Muri (probably ancient Halicanum). Its discovery however is not all too surprising considering the Međimurje region was a well known transit area. Close to the Sveti Martin na Muri there was a key river crossing in the ancient times.

Key words: Roman pottery, Pannonian slipped ware, Roman Stamp, Sveti Martin na Muri, Halicanum

Međimurje is the northernmost area in the Republic of Croatia, and located on the tri-border of Croatia, Hungary and Slovenia, forming an elongated triangle bounded by the rivers Mura and Drava. Geographically, the Međimurje region is located in direct contact with two large relief units, namely the Eastern Alps and the Pannonia Plain (Heršak, Šimunko 1990: 571). From prehistoric to modern times now, the geographical position of Međimurje determined its value and potentials. Its rivers Mura and Drava and numerous thermal springs and streams moved the population towards trade, agriculture and viticulture (Korunek 2009: 86). Although the Drava and Mura interflaves have been connected with the rest of Europe by trade routes since prehistoric times, only in the ancient period did the exchange of resources and economic activity pass into the sphere of command economy, largely governed by the Roman Republic and later, the Roman Empire, within the Pannonia province (Puzak 2003:26). An important, and perhaps a key link for successful communication and Roman occupation is the newly built wide road network and new routes that pass or emerge through settlements, military strongholds, and important old and new marketplaces. The Romans turned the old tribal centers into *civitates peregrinae*¹, a reference point for the expansion of their administrative units, *municipia* and colonies, but they also built new cities (Tomičić 1986: 203).

An inevitable correspondence also took place in the interflaves, along the route of the old amber road from *Aquileia*, *Aemona*, *Celeia* and *Poetovio* to *Savaria*, *Aquincum* and *Carnuntum* (Milotić 2010: 401). It stretched through the Moravian Gate to the north, more precisely to the Baltic, through a river crossing that probably was located at Sveti Martin na Muri. The exact branch was recorded as vicinal route² that separated from *Poetovio* towards the northeast *Pannonia Prima*, through the area of today's Međimurje and Prekomurje (Gračanin 2010: 10). Today's settlement of Sveti Martin na Muri is located on the right bank of the river Mura and is, as already mentioned, close to the important prehistoric river crossing. It is very likely that this Međimurje village is located on the remains of an ancient municipality called *Halicanum* or *Alicanum*.

1 Socio-political and territorial term, which means a community made up of indigenous, non-Roman inhabitants of a wider area, without Roman civil rights. It can include several fortified hillforts (oppida).

2 For a detailed analysis of road routes with the mention of Halicanum, see: Gračanin 2010: 41, note. 162; Marcius: 2015; Milotic 2010: 402; Soproni 1979: 93-94.

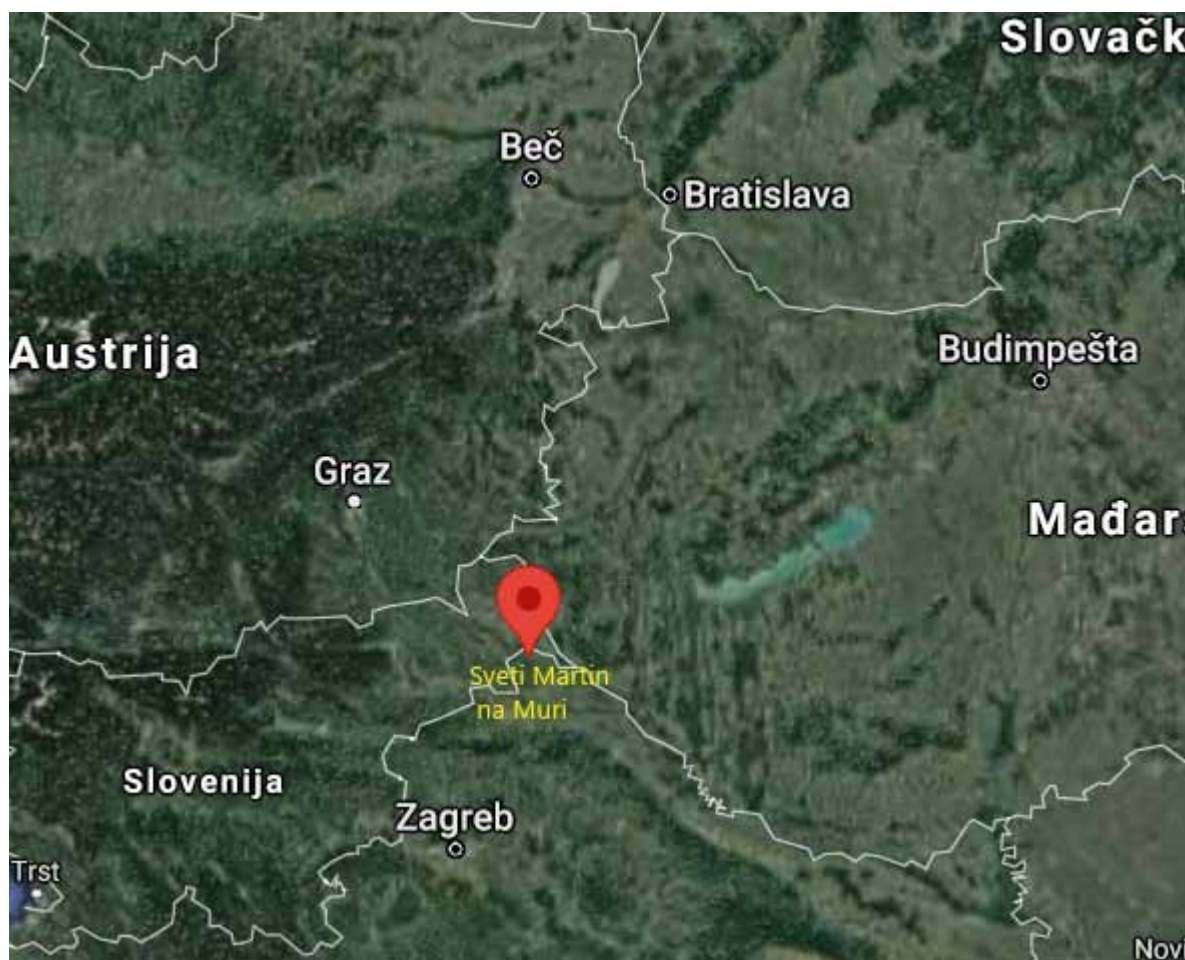

Map 1 The map showing the settlement of Sveti Martin na Muri (Source: Google Maps 1.1.2021.)

It is assumed that with the arrival of the Romans, *Halicanum* was established as a *civitas Serapillorum*, most likely located in the area of Serapili tribe. At that time it was located in the area of *ager Poetovionensis*, which stretched from the western border of Pannonia to Međimurje in the east; Varaždin Podravina and *Aqua lassae* in the south-southeast; in the northwest, it bordered the *ager of Flavia Solva* colony. As the neighboring *Salla* in the north at the time of Emperor Hadrian (117-138 AD) reached the rank of a *municipium*, it is assumed that *Halicanum* enjoyed the same fate. The *municipium* territory covered the area between *Salla* in the north, *Andautonia* in the south, *Poetovio* in the west and *Aquae Balissae* in the east (Tomičić 1986: 208). The altar of the consular benefactor *Titus Caesar Marcilinus*, dedicated to Jupiter, speaks of the importance of the *municipium Halicanum*. Consular benefit stations, which took care of the order, security and integrity of the property of Roman citizens, were usually located on the main roads and in prominent economic centers (Tomičić 1979: 42; Zaninović 2007: 181-184).

Archeological research in this area, which had begun in the mid-70s with several longer breaks, continued into the 21st century. The first systematic research was conducted on several occasions by the local Museum of Međimurje in Čakovec (Tomičić 1979-1986; Vidović 2003). Additionally, research of several rescue archaeological excavation took place in 2012. The new campaign was taken over by the Croatian Conservation Institute³ and continued from 2015 to 2018. As early as 1978, it was noticed that there was a "huge amount of pottery" alongside the entire village (Tomičić 1984: 62-63), and significant remains of a pottery kiln were found.

These were indicators of the possible existence of a smaller pottery workshop at this site (Tomičić 1984: 62 -63). Furthermore, from 1979 to 1981, a Čakovec Museum archeological department began researching Noric-Pannonian burial mounds with cremation ritual features in Trnovčak, not far from Sveti Martin na Muri. The material, which consists of various fragments of *terra sigillata* and coins, dates the site to the period from the second half of the 1st century AD to

³ The leader of the excavation was Lea Čataj, PhD from the Croatian Conservation Institute. Thanks for providing the material.

the first half of the 2nd century AD (Tomičić 1982: 41). However, the archeological research in the village itself did not begin until the years 2003/2004, searching for a potential “pottery district”. In these two campaigns, two pottery kilns⁴ were indeed recognized. Additionally, other material was found, mostly pottery dating from the first to the 6th century AD (Vidović 2003: 16). In 2015, the Croatian Restoration Institute began trial and then systematic research, aiming to determine dimensions of the presumed ancient settlement. The assumption was that it extended south of today’s main road. Although neither significant architecture (except for a few walls) nor other immovable heritage has been found, it is still assumed that the new settlement sat on the old ancient one. Among the finds, most are of ancient provenance, while a smaller part belongs to the prehistory, period of the Middle and New Ages / recent times. The most numerous are pottery and construction materials finds. Those made of metal, glass and stone were found in smaller numbers. Animal bones were found in smaller numbers in all layers. The recognized pottery forms were plates, bowls, three-legged bowls, cups, jugs, amphorae, pots, lids, grinders, dolias and oil lamps.

Fine pottery, *terra sigillata*, its imitation and thin-walled pottery was found in smaller quantities, while the most common were functional kitchen and construction pottery, probably of domestic production (Čataj 2016). Pots predominate among the domestic pottery found, because they are mostly used and mainly subjected to wear and tear in the household, so the need for them was the greatest. Analogies for pots of domestic production are often found among *La Tène* pottery (Vikić-Belančić 1965: 103). As functional kitchen pottery was not imported, Romanization had a slower effect on provincial production of this type of pottery (Brukner 1981: 42).

Among the numerous pottery improvisations, mostly *terra sigillata* and thin-walled pottery, one base stood out, a Pannonian slipped ware (*Pannonische Glanztonware*), originating most probably from the eastern Pannonia circle. In the trench no. 25, a multitude of Roman pottery was found in stratigraphic unit 307, along with the 4 cm diameter base and about 1.8 cm high, most probably belonging to a bowl of Drag 37 type. The fabric is hard, grayish-brown in color (according to Munsell soil color description 7.5 YR 6/1, 5/1, 4/1). A lot of tiny quartz and iron inclusions are present in the clay, while the coating may not have existed or, if it has, it has not been preserved.



Fig. 1 Stamped pottery base (photo by: I. Andrašić)

4 From the field log, we learn that the larger circular furnace with a diameter of 1.47 m had one flat side, while the smaller oval-shaped furnace had a diameter of 1.18 m.

The most interesting part is the stamp located on the inside of the base, with the inscription *VERVS/RE* in negative. Imprinted twice with a mirror projected plant leaf ornament that stylistically belongs to the Pannonian grayware pottery, probably the Eastern Pannonian circle (Čataj 2016: 29-30; <http://www2.rgzm.de/Transformation/Magyarország/Glanztware>). After cleaning, photographing and recording with a Dino-Lite digital microscope, it was concluded that the negative of the stamp visible at the base was made in two steps, actually, the entire inscription was not part of only one, but two stamps. The letter *R* is written in two different fonts, and a clear boundary between the two seals can be seen. Therefore, it was concluded that the inscription *VERVS*, together with the leaf decoration, is part of one stamp, while *RE* is part of the other stamp.



Fig. 2 Stamped pottery based photographed with a Dino-Lite microscope



Fig. 3 Stamped fragment with an inscription RE

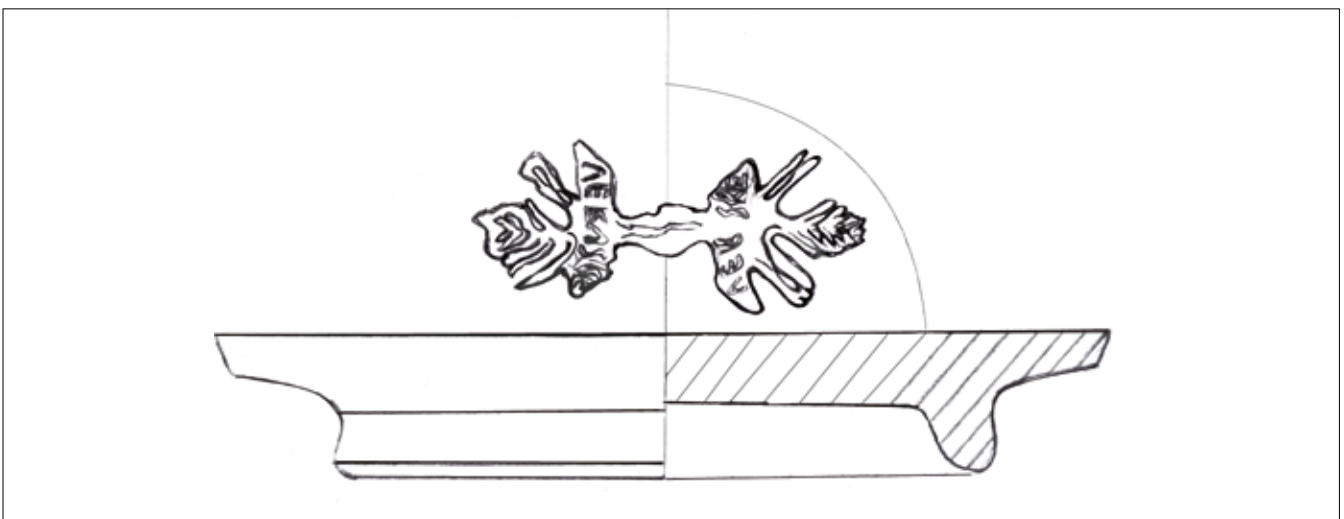

Fig. 4 Drawing of stamped fragment with an inscription

The name *Verus* is well known in Southern Gaul, *Noricum* and *Pannonia* where it occurs primarily on tombstones and on *terra sigillata*. Pannonian sigillates with this name are known from *Aquincum* to *Brigetio* (<https://www2.rgzm.de/Transformation/Magyarország/Glanztware/GlanztwareEnglisch.htm>), while one base of a Drag 37 vessel with the inscription *VERUS • F* was found in grave from *Magyarszerdahely* (Maróti 1987 Tab.3: 15), certainly a member of the Western Pannonian group dated to the 2nd or 3rd century AD. (Maróti 1987: 83; Horváth 1979 tab. 62: 5). Other finds of the *Verus* inscription also do not come with the *RE* abbreviation but with an *F* or a *FE*⁵. Also, the stamp is most often framed in *planta pedis* (Gabler et al 2009: cat. No. 639.1; 639.3; 639.6; 639.7) not in floral ornament. The very name *Verus* on

⁵ From the Latin *fecit*, meaning „made by“.

terra sigillata can be found in *Poetovio* (Abramić 1925: 96), *Mursa* (Bulat 1958: no. 70, 83), *Vindobona* (Kenner 1911: 155b), *Carnuntum* (Heydendorff 1949: no. 43; Kandler-Zöchmann 1996, no. 52; 54; 57) and *Brigetio* (Juhász 1935: no. 331, 155; Tab. XLVIX 331). In Hosszúvölgy, Zala County, grayware trying to mimic *terra sigillata* pottery was found in several pottery kilns, and the printed leaf motifs are similar to the floral motif from this fragment (Horváth 1981: 28). As much as there are similar analogies, an identical stamped pottery to this one from Sveti Martin na Muri has not yet been found. The dating of this finding is also questionable, and it is difficult to draw a definite conclusion.

However, judging from the name found on *terra sigillata* along with other well-known names (*Helenius*, *Comitalis VI*, and *Abbo*) and according to some authors, the seal with the appearance of the name *Verus* could be dated to the late second or early third century AD. More precisely, from 180 to 210 AD (Hofmann 1972: no. 282, 36). Together with numerous discoveries of *terra sigillata* and functional kitchen ceramics, this is a rare discovery in Sveti Martin na Muri, however, its discovery is not all too surprising considering the Međimurje region was a well known transit area.

BIBLIOGRAPHY / LITERATURA

- Abramić M. 1925, *Poetovio: Führer durch die Denkmäler der römischen Stadt*, Wien, Verlag der österreichischen Staatsdruckerei, VIII, 200.
- Brukner, O. 1981, *Rimska keramika u jugoslovenskom delu provincije Donje Panonije*, Beograd.
- Bulat M. 1958, Terra sigillata s pečatima u muzeja Slavonije (Estampilles sur les potiers sigillées à Mursa), *Osječki zbornik*, 6, 73–88.
- Čataj L. 2016, *Izveštaj o arheološkim istraživanjima nalazišta Sveti Martin na Muri u 2016. godini*, Zagreb.
- Gabler, D., Márton, A., & Gauthier, E. 2009, La circulation des sigillées en Pannonie d'après les estampilles sur sigillées lisses de Gaule, de Germanie et de la Région danubienne, *Revue archéologique de l'Est*, tome 58, 205–324.
- Gračanin, H. 2010, Rimske prometnice i komunikacije u kasnoantičkoj južnoj Panoniji, *Scrinia Slavonica: godišnjak Podružnice za povijest Slavonije, Srijema i Baranje Hrvatskog instituta za povijest*, 10, 6–69.
- Heršak, E., Šimunko, J. 1990, Međimurje – povijest, identitet i seobe, *Migracijske i etničke teme*, Vol. 6 (4), 569–591.
- Heydendorff W. 1949, Töpferstempel auf Terra Sigillata aus Carnuntum, *Mitteilungen des Vereins der Freunde Carnuntums*, 2, 5–6.
- Hofmann B. 1972, Catalogue des estampilles sur vaisselle sigillée, *Les ateliers de Montans, des Martres-de-Veyre, d'Argonne et de Rheinzabern*, Paris, 36.
- Horváth L. 1979, *A magyarszerdahelyi kelta és római temető*, ZGY 14.
- Horváth L. 1981, A hosszúvölgyi római fazekaskemencék. – Roman pottery kilns found in: Hosszúvölgy, *Iparrégészeti kutatások Magyarországon. Égetőkemencék régészeti és interdiszciplináris kutatása*, J. Gömöri (eds.), Sopron, 1980. VII. 28–30. Veszprém 1981, 27–32.
- Jelinčić Vučković K., Bertol A. (eds.) 2015, *Roman Village in the Province of Upper Pannonia: Virovitica Kiškorija South*, Monographs of the Institute of Archaeology, Zagreb.
- Juhász G. 1935, Die Sigillaten von Brigetio, *Dissertationes Pannonicae*, II.3, Budapest, 201.
- Kandler-Zöchmann Ch. 1996, Terra Sigillata mit Töpferstempeln aus der ehemaligen Sammlung Heydendorf, in: *Römerzeit-Mittelalter: archäologische und kulturwissenschaftliche Beiträge*, Festschrift Herma Stiglitz, D. Knibbe (eds.), Petronell, 51–59.
- Kenner Fr. von 1911, Römische Funde in Wien 1908–1910, *Jahrbuch für Altertumskunde*, 5, 107–162b.
- Korunek, M. 2009, Overview of Roman Heritage in Region Međimurje in Croatia, in: *Collection of works from the Symposium "Water, Life and Pleasure" in 2008. / Strumica*, 2009, 85–95.
- Puzak, I. 2003, Međimurje u prapovijesti, antičkom i srednjovjekovnom razdoblju, *Pregled povijesti Međimurja*, Povijesno društvo Međimurske županije, Čakovec.
- Nagy A. 2017, Resatus and the Stamped Pottery, *Aquincum Studies 1*, Budapest History Museum, Budapest.
- Marcuš B. 2015, Rimska cesta od sela Preseka do Svetog Martina na Muri u Međimurju, *Godišnjak zaštite spomenika kulture Hrvatske*, 39 (39), 65–76.
- Maróti É. 1987, Római kori pecsételt kerámia Nyugat-Pannoniában, *Zalai Múzeum 1*, 81–103.
- Milotić, I. 2010, *Rimska cestovna baština na tlu Hrvatske*, Hrvatsko društvo za ceste – VIA VITA, Zagreb.
- Soproni, S. 1979, Municipium Halicanum, *Folia archaeologica*, 30, Budapest, 91–98.
- Tomičić, Ž. 1979, Zaštitna arheološka istraživanja u Martinu na Muri, *Muzejski vjesnik. Glasilo muzeja sjeverozapadne Hrvatske*, Vol. 2, 2; 40–43.
- Tomičić Ž. 1982, Arheološka istraživanja antičke nekropole kod sela Trnovčaka u Međimurju, *Muzejski vjesnik* 5, 41–48.
- Tomičić Ž. 1982, Rezultati arheoloških terenskih rekognosciranja Međimurja u 1981. godini (antika i rani srednji vijek), *Muzejski vjesnik* 5, 48–54.
- Tomičić Ž. 1984, Sumarni osvrt na rezultate arheoloških istraživanja područja Međimurja u razdoblju od 1972 – 1982. godine (I), *Muzejski vjesnik* 7, 56–65.
- Tomičić, Ž. 1986a, Arheološka slika antike u Međimurju, *Međimurje*, Vol. 9 (9), 183–18.
- Tomičić Ž. 1986b, Arheološka slika antike u Međimurju, *Međimurje, časopis za društvena pitanja i kulturu* 9, 183–218.
- Vidović J. 2003, Arheološki nalazi i nalazišta antiknog doba u Međimurju *Katalog i vodič stalnim postavom*, Čakovec.
- Vikić-Belančić B. 1965, Neka obilježja ranocarske keramike u Jugozapadnoj Panoniji, *Starinar* 13/14, Beograd, 89–112.
- Zaninović, M. 2007, Beneficarii consularis in the territory of the Delmatae, *Prilozi Instituta za arheologiju u Zagrebu*, Vol. 24 (-), 181–184.

ELECTRONIC SOURCES / ELEKTRONIČKI IZVORI

<http://www2.rgzm.de/Transformation/Magyarorszag/Glanztonware> (25 April 2021)

SAŽETAK
POSUDA S *VERUS RE* PEČATOM IZ SVETOG MARTINA NA MURI.

Ključne riječi: Rimska keramika, Panonska siva keramika, Rimski pečat, Sveti Martin na Muri, Halikan

Prilikom sustavnih arheoloških istraživanja koja je Hrvatski restauratorski zavod od 2015. do 2018. godine provodio u mjestu Sveti Martin na Muri, 2016. godine pronađeno je jedno dno sive panonske keramike (*Pannonische Glanztonware*) s natpisom. U ovom radu autorica donosi problematiku koja je nastala prilikom pronalaska tog dna s pečatiranim natpisom *VERUS RE*. Čini se kako je pečat utisnut u dva navrata, a njegova datacija mogla bi se pripisati kraju 2. i početku 3. st. po. Kr. Uz brojne nalaze tere sigilate i grube kuhinjske keramike, ovo je rijedak nalaz u Svetom Martinu na Muri, iako njegov pronalazak ne iznenađuje obzirom na to da je Međimurje oduvijek bilo tranzitno područje, a pored Svetog Martina na Muri (koji je vjerojatno antički Halikan) bio je smješten ključan prijelaz preko rijeke Mure.

PANNONIAN SLIPPED WARE FROM MURSA: VIEW OF THE CURRENT LEVEL OF RESEARCH

In the last twenty years, excavations of Mursa unearthed dozens of well-defined archaeological sites (contexts) from the 2nd and 3rd centuries. Some contexts have origin defined within several decades. The collected material makes Mursa one of the best sites in Pannonia to study 2nd-century Roman material culture. Considering that many finds of Pannonian slipped ware (PSW) derives from such stratigraphic units from the late 1st century to the 3rd century, Mursa is currently one of the best sites for research on PSW. Pottery study showed that the PSW in Mursa derives from two "production lines". One production line relies on the forms taken from imported terra sigillata and the production line that includes all those products that are not shaped in the forms of the terra sigillata model. Both production lines last from the second half of the 1st century to the 3rd century. The pottery study from Mursa did not yet reveal exact chronological stages of PSW development; still, both production lines show certain chronological regularities. This paper outlines future research for both production lines and PSW typology.

Key words: Pannonian slipped ware, Pannonian pottery, terra sigillata imitations, Mursa, southern Pannonia

A pile of fragmented pottery collected during an archaeological excavation can easily lead archaeologists to despair. Processing and sorting a chaotic pile of ceramic fragments usually requires considerable time and energy. The results often, without false self-deception, do not correspond to the effort made. Therefore, every specialist that deals with Roman ceramics at least once asked himself: "Why am I doing this? This work is madness!" But, as W. Shakespeare wrote in Hamlet, "Though this be madness, yet there is method in 't". The main task of archaeologists is to establish a system in this amorphous pile of finds and turn it into a source of data whose processing makes sense. The defined pottery groups are the base of such a system. Such distinctive groups provide data that can contribute to a broader understanding of historical processes in (Roman) society. The best examples of such pottery are global groups such as *terra sigillata* and *amphorae*, but gradually local and regional groups are becoming increasingly important. Some groups have been known for a long, while specialists some defined relatively recently. One such newcomer to the Roman-provincial archaeology is Pannonian slipped ware (from now on: PSW). Austrian archaeologists I. Pavić and K. Adler-Wölfl defined it back in 2004 as *Pannonische Glanztonware*. Pavić and Adler-Wölfl devised a local pottery group to amalgamate imperial fashion and local tradition. They did it on the material from a somewhat limited area, Vindobona and Carnuntum clearly stating that this pottery is a regional phenomenon in Pannonia (Adler-Wölfl 2004; Pavić 2004). Over the past 15 years, PSW has taken root in Central European Roman-provincial archaeology, and several experts have adopted it in their work. However, it is still relatively unknown outside the narrow circle of experts in Pannonian pottery. It is essential to emphasise that some findings belonging to this group are present in different publications under other labels due to the relatively recent definition of PSW. The best example is PSW from the western cemeteries of Petovio, published in the book by J. Istenič as imitations of terra sigillata. Interestingly, PSW is still published in some Slovenian editions as imitations of terra sigillata, continuing to apply the approach set by Istenič in 1999, which speaks of the slow harmonisation of classifications and too slow adoption of new groups in some areas (Figure 1).



Fig. 1 Photograph of the completely or partly preserved PSW vessels used in this study. (photo by T. Leleković)

Some experts are always keen to discuss the nature of PSW. However, it is questionable to have such a discussion on this level of research considering that this group still lacks clear typological definitions, which would enable experts to determine which pieces are PSW and which are not. Also, there is still no uniform position on what types of pottery consists of PSW and the true nature of this group. I. Pavić and K. Adler – Wölfl and some other experts in Austria believe that PSW was not the imitation of imported *terra sigillata* but an authentic type of ceramics modelled in the fashion of *terra sigillata* by taking just some of the characteristics from *terra sigillata*. J. Istenič argues the opposite view on this matter. Namely, she describes PSW as a local imitation of *terra sigillata*, fired in reduced and oxidising atmospheres (Istenič 1999: 91-103). It is important to note that Istenič published her book five years before Adler – Wölfl's book. The only possible conclusion on the nature of PSW is a compromise between these opposite views. Therefore, PSW is an eclectic pottery group that include several subgroups. Local *terra sigillata* imitations make one subgroup. Authentic forms modelled with some elements of *terra sigillata* while at the same time retaining a certain amount of originality makes another subgroup. Pieces with no resemblance to *terra sigillata* comprise the third dominant subgroup. It is important to note that some Pannonian pottery groups previously defined as distinct groups/types should be included in PSW. In addition to the finds mentioned above from Ptuj, the PSW should also include pieces of local relief *terra sigillata* of the Pacatus workshop and so far poorly studied relief *terra sigillata* from Poetovio (Kiss 1938: 212-216; Tomanič-Jevremov 2004: 95-97). It is evident that the definition of this group is still ongoing and that many threads of research are not yet thoroughly intertwined. That is why the guiding line of the study on this specific ceramic group should be: "What can we learn from Pannonian slipped ware?" Or "What must be the goals of dealing with Pannonian slipped ware?". The search for these questions will lead to conclusions and definitions that are now lacking. It is this search that is the backbone of this work.

PANNONIAN SLIPPED POTTERY FROM THE PRE-COLONIAL CEMETERY IN MURSA

The PSW would probably never have come into my focus if not for the rescue excavation in the Trg bana Josipa Jelačića in Osijek in 2008. The earliest excavated features were graves that preceded the foundation of colony Aelia Mursa in 133 AD. The earliest find from these graves is a fragment of Sirmium-type thin-walled pottery dated to the Flavian period. It was impossible to establish horizontal stratigraphy within this group of 102 graves, so these graves make one context spanning from the late Flavian period until the year 133. Volute lamps Loeschcke Ib/c type and Loeschcke Ic type and stamped lamps of the Loeschcke IX type and Loeschcke X type confirm the origin of these graves to the last decades of the 1st century and the 2nd century (Leleković 2008; Leleković 2020: 95).

The duration of this cemetery overlaps remarkably with a crucial period for the study of Roman pottery in Pannonia. Namely, this is the time of change in the supply of fine ceramics during which import from northern Italian workshops gradually declines and imports from Gaul are progressively replacing them. In south-eastern Pannonia, archaeological

contexts from that time are scarce, so these graves are a rare insight into the time of change. The pre-colonial cemetery of Mursa currently revealed the most significant PSW sample from the end of the 1st and the beginning of the 2nd century in the region. Perhaps the excavation at Sisak Railway Station will make Siscia the leading site in the number of PSW findings from this period (Drnić 2018). However, the material from that particular excavation of Siscia is still mainly unpublished. Maybe the forthcoming publication of the findings from Siscia and those from Petovio could make a change, but not necessarily. Namely, the pottery analysis from the excavation in Braće Radić Street in Sisak showed negligible PSW in the layers corresponding to that time. The excavation executed in 2012 revealed three contexts: the pre-Roman (La Tène) layer, the several successive layers that made the context of legionary camps dating from the time of Augustus to the Flavian period, and the first colonial layer consisting of the remains of a pottery workshop that produced thin-walled pottery, dating in the last decades of the 1st to the first decades of the 2nd century. The Flavian layer had a large amount of thin-walled pottery, but only a few PSW. Among which is a find interesting for the study of PSW is a plate made in the shape of Consp. 18, which is a local imitation of the Aretine terra sigillata plate shape, probably the product of the legion workshop (Leleković 2018). However, this plate cannot be considered PSW but a predecessor of PSW that indicates that PSW could stem from the legionary workshops of Pannonia.

The excavation revealed negligible PSW finds in Radićeva ulica in Sisak. Namely, a brick and stone building built at the end of the 1st or in the first decades of the 2nd century concludes the site's stratigraphic sequence. The construction of this building stopped the formation of residual layers at that location, for communal dumping areas functioned in that stage of the colony's development. Therefore, other positions in Siscia may reveal the same, so it isn't easy to envision a more significant amount of material from the 2nd century within the walls of Siscia. Material complementary to Mursa in Siscia should be sought elsewhere, outside the city walls, primarily at garbage dumps around the city.

Almost all PSW pieces from the pre-colonial cemetery of Mursa resembles imported sigillata. Therefore, it is crucial to resolve the problem of the relation between PSW and the imported terra sigillata. As mentioned before, one option is that PSW occurred as a local imitation of terra sigillata, meaning that PSW production complemented terra sigillata import due to lack of it on the market or due to too high price. This fact should reflect on PSW, for products would mirror the shapes and sizes of terra sigillata present on the market. The alternative would assume that the PSW complemented sigillata for an insufficient palette of shapes and sizes among the import. Therefore, collected PSW has forms and sizes different from the terra sigillata at that time, for it has those sizes and shapes lacking on the Pannonian market. The first option would mean that PSW is the imitation or the local copy of terra sigillata, while the latter implies that it is the interpretation of the terra sigillata. On this level of research, it is impossible to resolve this problem, so in the further description of the PSW, I will use the term style, as some other specialist (Ožanić Roguljić 2016: 97-99), as a neutral term that allows both explanations. Styles mirror the forms of terra sigillata imported in Pannonia during this period: PSW made in a style that was typical of the Italian terra sigillata, those made in style distinctive of the Gallic terra sigillata, and those that cannot be associated with any particular style, so that style can be considered authentic.

PANNONIAN SLIPPED WARE MADE IN THE ITALIAN STYLE

Pre-colonial graves mostly revealed the PSW made in style created in Italian workshops during the 1st and 2nd centuries (Fig. 1; Plate 1: 1-19; Plate 2:3). The forms that make up the Italian terra sigillata style are collected and processed in the Conspetus (Ettlinger et alii 1990). It is important to emphasise that this style was not limited to Italy. Most workshop centres in the provinces began producing terra sigillata in Italian style, developing their original forms in later production. That is why it is sometimes difficult to determine from which direction the influences on local production came, i.e., the origin of the prototypes used in the production. However, *terra sigillata* from Po valley dominated the Pannonian market during pre-colonial Mursa, so it is almost certain that the northern Italian terra sigillata was the prototype for the Italian style PSW. Accordingly, the S. Zabežlicky-Scheffenegger scheme of four primary services seems the most appropriate for a more detailed analysis of the examples made according to Italian prototypes (Zabežlicky-Scheffenegger 1990a, 49-50).

Service A. The vessels shaped in Tardo-Padana service A makes the most numerous typological group in the cemetery, consisting of ten bowls of shape Consp. 43 and two plates of the form of Consp. 39. The main characteristic of these vessels is the hemispherical body with a hooked (drooping) rim (Ettlinger et al 1990: 120-121, 128-129). The body and rim of the vessels have an almost uniform shape. The only deviations from the original form are visible in the shaping of the base. Two bowls (109.1, 278.2 (Pl.1: 2) have a proper footing with a thickening in the centre of the bottom, as in the Italian terra sigillata originals. Two bowls (189.1 (Pl. 1: 3), 286.1 (Pl. 1: 6) have a "low footing" with a barely noticeable base thickening,

poorly imitating the Italian prototype. Finally, three bowls (204.1, 263.1 (Pl. 2: 3), 278.1) have a flat base decorated with grooves with no resemblance to terra sigillata. The bodies and rims of the two dishes are also somewhat similar in shape while differing in the base. Plate 318.1 has a proper footring, while plate 396.1 has a flat base. Most bowls have a uniform size with a rim diameter of 14 cm to 16 cm (109.1, 6, 189.2, 2, 1, 4, 31, 314.1, 319.2 (Pl.1: 1-6)). Only cups 278.3 and 405.1 have smaller diameters of 7 cm and 9 cm.

In this context, the two only discovered dishes differ significantly in appearance and size. Dish 318.1 (Pl. 1: 10) has a diameter of 15 cm, and dish 396.1 (Pl.1: 9) has a diameter measuring 20 cm. Dish 318.1 has a dark grey coating with a metallic sheen. The interior is decorated with rouletting and stamped vegetable motifs, while plate 396.1 has a light grey matte coating. Its interior bears simple decoration with three incised irregular concentric circles, and its edge is faceted. It is difficult to draw any regularities on shapes and sizes based on the two dishes alone.

For the time being, the site that revealed the largest amount of (published) pieces of PSW Service A is Poetovio, owing to the publication of J. Istenič. The western cemetery of Petovio provided 23 bowls of shape Consp. 43 and 13 plates of the form Consp. 39. Variations in design are also visible in Ptuj, again mostly in shaping the bottom and colour of the coating. Oxidation-fired dishes prevail over reduction-fired ones. However, the colour of the slip varies from yellow-ocher to bright red (Istenič 1999: 91-103). Similar discrepancies are visible in other parts of southwestern Pannonia, such as in the Latobician territory. Excavated graves in the Gornja Vas cemetery revealed eleven bowls of type Consp. 43 and four plates type Consp. 39. vessels almost uniform in shape, with a pronounced drooping rim as a typological characteristic of this particular site (or the local workshop). The PSW from Gornja Vas does not deviate in its appearance from other specimens in the region. The drawings insinuate that these vessels are exemplary for their thin sides and refined artistry, but examination of findings in the Archaeological Museum in Zagreb proved different. The cemetery in Gornja Vas is dated quite widely, from Claudius to Marcus Aurelius. However, coins and Loeschcke X type lamps found in graves dating from the end of the 1st to the middle of the 2nd century is much more probable, which coincides with the dating of other finds from southern Pannonia (Gregl 2002: 122-123; Gregl 2007: 249-252). The Roman cemetery in Novo Mesto, in the Slovenian part of the Latobician territory, revealed ten more pieces of PSW (Knez 1992: 21, 36, 40, 43, 47, 69; Božič 2008: 179). The vessels are made relatively uniformly, as in Gornja Vas, which again shows that it is probably from the same workshop/master, except that the vessels are in shape closer to the findings from Ptuj than from Žumberak. From the territory of Andautonia, several pieces come from the Roman cemetery of Stenjevec (Zagreb). Retrieved grave goods included six bowls of type Consp. 43 and one plate type Consp. 39 (Gregl 1989: 26). Again, a highly standardised production is visible here, which corresponds in shape to the findings from Mursa and Poetovio. One of the rare finds from the settlement context stems from Cornacum (Sotin) on the Danube and from Siscia (Baćani et alii 2011: 119).

Service B. Excavations of the pre-colonial cemetery produced only two bowls that resonate with the style of Service B. Two pieces made in the form of Consp. 44, with shape, is the hemispherical bowl with an everted flat rim (Ettlenger et alii 1990: 130-131). A bowl 106.1 has a proper flat rim (Pl.1:5), while the vessel 189.1 slightly flares downwards (Pl.1: 6). Both bowls have a diameter of about 17 cm, so they are somewhat larger than examples of service A. Bonfire heavily damaged both pieces, so it is not possible to determine the original appearance of the coating. However, both were probably grey as fired under reduced conditions.

Service D. Shape Consp. 45 is the only specimen from Service D. Cup 103.2 has a hemispherical body with a flat rim and a raised edge (Ettlenger et alii 1990: 132-133). The bowl is slightly smaller than other Italian-style PSW with a diameter of 13 cm. This piece has the inner side decorated with rouletting, which resonates with the terra sigillata original. This piece is the only example of PSW from Mursa that bears the stamp with the manufacturer's name. Interestingly, the stamp MARIVS (in planta pedis) is identical to that seen on a PSW piece from Poetovio made in the shape of Consp. 43 (Istenič 1999: 97).

Another unique Italian style piece, cup under designation 297.1, is **a hemispherical bowl with a restricted body**. It has a rounded body with a pronounced horizontal restriction on half the height corresponding to the shapes of the Consp. 31/32 and Drag 27 (Pl.1: 7) (Ettlenger et alii 1990: 106-109). With a diameter of 17-18 cm, it is one of the larger pieces of PSW found in this cemetery. It stands out from the others with well-baked light pink clay and ocher slip. Still, it is possible, especially if the fragmentary nature of the vessel is taken into account, that it is not its original colour for possible colour change changed due to secondary burning. Although the prototype for this vessel most probably came from the Po valley, a similar terra sigillata vessel made in Gaul could also do that role for this particular bowl. Thus, this piece could be a link or a mixture of Gaulish and Italian styles (Dragendorf 1895: 110-111; Brulet 2010: 92-133).

PANNONIAN SLIPPED WARE MADE IN THE GALLIC STYLE

Gaulish potters produced terra sigillata in the Italian style until the 3rd century. Still, in parallel, from the 1st century, the workshops developed original forms, later taken over by workshops in Germany and Retia. These forms make the Gaulish style of terra sigillata. In the pre-colonial cemetery of Mursa, only two vessels can undoubtedly relate to this style. Interestingly, both derive from the same grave 241.

Hemispherical bowl. The bowl 241.1 imitates the shape Drag 37 (Pl.1: 12). The rounded body with a proper footring and simple rounded rim are typical for bowls type Drag 37. Relief decoration is another specific characteristic of this type of terra sigillata bowl. This specimen has a simple decoration made with a potter's wheel instead of decoration made in a mould. The space below the edge of such bowls usually bears *ovuli* (*Eirstab*), but the part below the rim has incised grooves on this specimen. Decoration obviously "imitates" relief decoration of the originals. The bowl is oxidising baked and has a light red coating. K. Adler-Wölfl defined such bowls as type Sü. 5.2. According to Adler-Wölfl (Adler-Wölfl 2004: 44-45), their production stems from the end of the 1st to the middle of the 2nd century. They remain in use of Sü. 5.2 lasts into the 3rd century. This type of vessel is also present in the western cemetery of Petovio. Istenič published three bowls of this type, earliest been a piece from a grave dating from the end of the Flavian period to the beginning of the 2nd century. Examples from Poetovio, from the same period as this grave in Mursa, were fired both under oxidising and reduced atmosphere (Istenič 1999: 100).

Dish of the rounded body with a raised bottom. Dish 241.2 (Pl.1:12) has a general appearance of Gaulish terra sigillata dishes, but it has elements from several different types. A rounded body makes this piece close to types Drag. 31 and Drag. 32, but the raised bottom and rouletting decoration are typical to shape Drag. 31R. On the other hand, the hooked rim is reminiscent of dishes made in the Italian shape of Drag 36 / Consp 39. The colour of the dish is also unusual. The ceramic has a yellow-brown colour, i.e. a yellow-ocher coating.

PANNONIAN SLIPPED WARE OF AUTHENTIC STYLE

In defining this subgroup, I use the term "style" fully aware that this is not a group with single cohesive style, but an eclectic group of PSW of authentic style includes forms that do not resemble Italian or Gaulish terra sigillata. These "authentic" forms do not have common typological or stylistic elements. The only fact that ties them into one group is their authenticity in their appearance. It is yet to explore how to deal with this group of PSW. Pavić and Adler Wölflöva defined the PSW as an amalgam of Roman influence and local La Tène traditions. It is necessary to emphasise that authenticity is not synonymous with the local La Tène tradition. Some forms have their roots in indigenous Celtic pottery, but some are entirely new authentic shapes without reference to local potter's tradition. After all, it is questionable how much the La Tène tradition could have played a role in forming the PSW in southern Pannonia. From the arrival of the Romans in south Pannonia to the Great Uprising in 6 A.D., a series of historical events ravaged the region, decimating the population. After the Great revolt, the Celtic Mursa no longer existed (Leleković 2020: 88-90, Leleković 2021: 258-261). Even if some pottery workshops continued to operate in SE Pannonia until the end of the 1st century, it is hard to establish the extent to which traditional pottery influenced the PSW. Namely, so little is known about southern Pannonia's Late La Tène pottery. Only a few quality studies are available on local La Tène pottery in the Croatian part of Pannonia (Dizdar 2001; Dizdar 2013). It is challenging to decide on whether some shapes derive from the La Tène tradition or whether these shapes are a consequence of the simplification of production or are this shaper the improvisation of artisans and experimentation in the palette of products. The material from the pre-colonial cemetery includes three forms of authentic PSW.

Concave-sided bowl. The first representative of authentic style is a concave-sided bowl whose main characteristics are a concave-sided body and a thickened rim. At first sight, these three bowls appear to be uniform, but each has unique features. Bowl 305.1 (Pl.1: 13) has a rim of a square cross-section, while bowls 103.3 (Pl.1:8) and 2012.1 (Pl. 2: 1) have rounded rims. Bowl 103.3 (Pl 1:14) has a proper footring, bowl 305.1 Pl.1:13 has a concave base without a foot (apparently made in a mould), while vessel 2021.1 (Pl. 2:1) has a concave bottom with a rib that mimics a footring. Bowls of this shape were used in Mursa for at least the entire 2nd century, considering that pre-colonial cemetery, colonial layers of Aelia Mursa in the University Campus and Park kraljice Katarine Kosače includes it. It is interesting to observe that concave-sided bowls are fired under a reduced atmosphere in pre-colonial contexts, with grey and black slip. In contrast, a quarter of these bowls, derived from the colonial layers, are yellow and red surfaces, clearly fired under oxidising conditions.

The exact provenience of this form is hard to establish. The concave-sided body and sharp base angle are reminiscent of Gallic bowls Drag.33 and Italian bowls Consp. 49. Since both types are present on the market while pre-colonial cemetery was in use, influence from both regions is possible. Similar bowls originate from a military settlement in Aquincum. The Hungarian colleagues suggest that the impact on their design came from the East via Eastern Sigillat B 2, i.e. that they are imitations of Hayes 75 vessels (Gabler et alii 2009: 65-69). Here one has to add that these bowls, in their appearance, are also close to forms Hayes 58 and Hayes 73 (Hayes 1985: 63, 68). This kind of bowl is a very sought-after form throughout the Danube region. A reduced fired piece from the Roman cemetery Stenjevec (Gregl 1989: 26) and several oxidised fired from Singidunum (Belgrade) (Nikolić-Đorđević 2000: 34-35). Bowls of this shape are also found elsewhere in the northern provinces. Thus they are found in the cemetery 'Feldbergstrasse' of the Roman settlement of Nida (Frankfurt a. M.-Hedderheim) attributed to the production of the Wetterauer group (Wetterauer Ware). This type of bowl (Wetterauer Ware type I 2) are present also in the Rhineland. True, they differ from PSW in colour because the Wetterauer Ware is fired under oxidising atmosphere. These dishes have a red glossy slip similar to terra sigillata but similar to Pannonian concave-sided bowls (Arveiller-Dulong and Nenna 2005: 274). Given all this, it is difficult to make a final judgment about the origin of this form. It is possible that this form of PSW has nothing to do with terra sigillata but that it is simply a form of tableware that became fashionable at the end of the 1st century. This same shape is used equally by workshops of regional groups such as PSW and Wetterauer Ware, but also a large centre that mass-produced terra sigillata and glassmakers and metallurgical workshops for the production of metallic vessels. So, it may be wrong to insist on looking for a particular prototype on the imported terra sigillata or in the repertoire of local tradition. Still, the correct way would be to recognise this shape on different dishes and recognise it as an element of current fashion. To resume, at the turn of the 1st century, this form became popular, and there was a demand for it. So, in this case, it would be an authentic product made according to global fashion.

Vessel 364.1 (Pl. 1:15) is close to this group. There are similarities with concave-sided bowls, but it also differs from them. A common feature is a broad concave side for which bowl 364.1 resembles the concave-sided bowls. Furthermore, it has a "false" footring as bowl 2012.1. It is also reduction-fired, although the quality of artistry and the quality of the coating is significantly better than all three "proper" concave-sided bowls. Another feature, the horizontally drawn edge resembling service B (Consp. 42), distinguishes it from the "proper" group. Other important distinguishing components are its dimensions and proportions. Namely, with a height of 45 mm, a diameter of 162 mm, and a slightly wider bottom relative to the opening, it connects this bowl with Gallic deep plates of Drag shape. 18/31. It is possible that this is again a style crossover, this time from Gaul, and that it is a local combination of two different styles made according to the taste of the local Pannonian market.

Rounded bowl of wide-drawn walls. Two somewhat large bowls make the second authentic form. The defining characteristic of this type is a wide rounded body so that these bowls could almost be dishes. The moulded base has a slightly raised bottom in the centre, while the outer edge of the base has profiling resembling a low footring. O. Brukner considered this form of PSW imitations of the terra sigillata form of Drag. 40. However, if this type derives from the imported ware, the shallow and wide body resembles the Eastern sigillata forms ESB 9 and ESB 80. Although they have the same basic shape, the bowls differ considerably in appearance. The bowl 319.1 (Pl 1: 17) is oxidising-fired and has a red coating, the only decoration being three thick incised lines on the outside of the wall. The Pl bowl is fired under a reduced atmosphere with a dark grey coating. At the same time, the decoration is considerably more elaborate, while the inside is decorated with rouletting and stamped vegetative motives. Another distinctive characteristic is the way the forming of body. Bowl 319.1 has sides of uniform thickness and a simple upright rim, while bowl 409.1 (Pl 1: 16) has sides thicker in the upper part than in the lower part of the body and a thickened rim.

The fundamental question is whether the Eastern Sigilat B is the primary prototype for this form. Considering that the eastern terra sigillata is a scarce find in Pannonia, this question relate again to the nature of PSW. Namely, the essential question is whether the PSW was made in the shapes of imported terra sigillata to supplement the market that imports could not fully satisfy. Then, the range of shapes and sizes of the PSW would reflect the shares on the market of the particular terra sigillata workshops. In that case, is it possible that there was the influence of the East on the PSW production, while the findings of the eastern terra sigillata in Pannonia are almost non-existent? The fact that there is a constant influx of terra sigillata from northern Italy during the second half of the 1st century and the first half of the 2nd century is generally accepted. However, north-Italian terra sigillata from this period in southern Pannonia are scarce (Makjanić 1995: 43, 75). It is necessary to deal with the presentation of specific imports in the future. By themselves, they are rare to give us an accurate

picture of the composition of the terra sigillata arriving in southern Pannonia. At the same time, graves equipped with PSW found in the service style of the northern Italian terra sigillata stems from Ljubljana to Gomolova. Therefore, there is also no reason to reject the eastern terra sigillata as a possible means of influencing the production and shaping of the PSW in southern Pannonia.

Interestingly, both rounded bowls, some concave-sided bowls and Gaulish style dish OS-TRG 08-SF 3643 (PI 1:11) have a slightly raised bottom, typical for the Gaulish terra sigillata dish type Drag. 31. It would be interesting to re-examine whether this fashion came from Gaul with this specific shape of terra sigillata dishes.

Pot with a conical shoulder. The third authentic form is the only type related to the indigenous La Tène tradition. Both pots are unique in their appearance. As with other authentic forms in the pre-colonial cemetery, these two vessels are similar, but each has distinctive characteristics. They are two very different versions of the same type. Both pots have a biconical body with the largest width in the middle. Both have a flat bottom and everted bevelled rims. But pot 263.2 (PI 1: 18) is fired under a reduced atmosphere, with a grey / olive-green coating. The diameter of the body is larger than the height of the pot (h: 150 mm; d: 175 mm). The conical shoulder bears a rouletting decoration. Pot 409.2 (PI 1: 19), on the other hand, is fired under an oxidised atmosphere. It has a light red coating, and it carries a rouletting decoration with red paint. The height of the body is larger than its diameter (h: 170 mm; d: 145 mm).

Findes From the 2nd century BC La Tène cemetery Zvonimirovo - Veliko Polje includes pots of this same type. Therefore, this is the only type of PSW from the pre-colonial cemetery that reflects the indigenous La Tène tradition. Such pots in the 2nd century BC. were widespread among the native communities throughout the Pannonian-Danubian area (Dizdar 2013: 276-291). Still, with a lack of published material from the turn of millennia, it is hard to determine which forms local native potters still were using at the time of the arrival of the Romans.

PANNONIAN SLIPPED WARE FROM COLONIAL STRATA IN MURSA

Residual layers from the colony period of Aelia Mursa provide rich material for the study of PSW. Pottery from rescue excavations of the last 70 years, which revealed a large colony area Aelia Mursa, is stored still unprocessed in the Archaeological Museum Osijek. However, the Archaeological Division of the Croatian Academy of Sciences and Arts in Zagreb stores finds from our excavations of Mursa during the past 15 years: the excavation on Trg bana Josipa Jelačića in 2008 that revealed the remains of the pre-colonial cemetery, a suburb and thick residual layers from the 2nd and 3rd century; excavations in Park kraljice Katarina Kosača Park from 2012 to 2018 that revealed a section of the colony within the city walls, also revealing the earliest colonial strata; excavations of the colony's western suburb that the Academy executed from 2016 to 2021 at the University Campus; and finally finds from the excavation that the Academy conducted in front of the southern city gate of Mursa revealing remains of a suburb and thick residual layers from the 2nd and 3rd centuries. Therefore, these excavations provide a compact sequence of well-defined contexts that continue in the context of the pre-colonial cemetery up to mid 3rd century.

The study of this considerable amount of finds is still in process, so it is impossible to give a complete overview of the PSW from Mursa. However, I would like to use this opportunity to disseminate at least some of the results obtained from current research on the material from colonial strata. One thing must be emphasised: each selected colonial context revealed some new developments considering the PSW. It is hard to imagine that the entire material will ever be completely processed. Therefore, the study also aims to detect the right amount of data valid for the conclusions. This aim is unrealised, so this chapter intends to provide an insight into the current state of research and present guidelines for future research without any final decisions.

The current study focuses on finds from Park kraljice Katarine Kosače. The importance of this location derives from the results of the excavations that showed that brick and stone buildings replaced those made of wood two or three decades after establishing the colony. The "solid" structures prevented the further formation of cultural layers, so all residual layers that preceded brick-and-stone-phase are related to the wooden buildings of the first generation dated between 133 and 270s at the latest. Therefore, these layers provided the PSW sample from the period that continues from the pre-colonial cemetery.

The study of material gave a much more diverse picture than the pre-colonial cemetery. These findings show a greater variety of coatings and a greater variety of shapes. Grey and black PSW still prevail, but the share of red PSW has increased significantly so that the ratio is approximately 1:3 in favour of reduction-fired ceramics. The yellow and brown PSW fragments are exceptional. The palette of coatings includes all red and grey coatings variations, precisely according to the

template designed according to the findings from the pre-colonial cemetery. The coating was applied only on a particular surface on some vessels, while the part was without slip, which was not the case on the pre-colonial cemetery. This variety of finds open the question is all regional or locally made coated pottery from this period PSW? If not, which coated pottery is PSW and which is not? For example, how to deal with imitations of Rhaetian cups? Should they be considered distinct ceramics, or are they part of the PSW as imitations of terra sigillata? Also, how to deal with plates/dishes whose interior carries a high-quality red coating. This type of tableware is typical of the 2nd and 3rd centuries, but it is hard to include in the PSW repertoire.

The PSW of styles defined in the pre-colonial cemetery is still present in large amounts. These finds are the core, which can correlate to other potential PSW finds. There are some differences in “the core group”. Contrary to the pre-colonial context, the Gaulish style PSW is more numerous in the colonial layers than in the Italian style. Such development is logical given that the Gaulish terra sigillata was dominant on the market. Bowls made in the shape of Drag 37 stands out. Some pieces bare stamped decoration that imitate the relief decoration typical to terra sigillata bowls of this type (PI 2: 8-11). PSW Italian style is present mainly with services A and B (PI 2: 3). Suppose that these finds reflect the situation on the market in Mursa. Then, these finds show that the Gaulish sigillata has not entirely changed the market’s taste and that Italian style sigillata was still present on the market in the second half of the 2nd century.

Concave-sided bowls attributed to the authentic style are also standard for this period, especially in layers up to the middle of the 2nd century (PI 2: 1-2). The critical novelty is oxidised-fired pieces with quality red coating and grey pieces. There are also novelties in the design of these bowls. For example, some bowls have sides thinned towards the rim, resembling glass cups of the same shape. Pots with a conical shoulder are also still present in colonial layers. However, it is impossible to single out at least one piece among fragments, so comparing it with those from pre-colonial graves or La Tène prototypes is challenging. However, according to these fragments, it is possible to detect that pots with conical shoulders in this period are much more refined in execution, i.e., elegant shapes and coating. Also, it is difficult to determine whether a body fragment derives from a pot with a conical shoulder or a jug. The third form that appears in significant numbers in the colonial phase are dishes, especially those with a horizontal edge decorated with rouletting, as published by Adler-Wölflova from Carnuntum (Adler-Wölfl 2004: 35-35). These dishes correspond to dishes produced in northern Italy during the second half of the 1st century and the first half of the 2nd century. Like most of the then north Italian terra sigillata, these dishes were widespread in the Danube region (Ettlinger et al. 1990: 122). O. Brukner published from Sirmium a similar dish with a decorated edge (plate type 5), which she placed in the time of Claudius (Brukner 1981: 86).

Collared bowl. Of the new forms, the most visible are the bowls known under the German name Ringschlüssel. These bowls have a rounded body with rim that resembles a ring or a rib. The clubbed rim is rather large concerning the body (PI 2: 4-7). This ‘clubbed strip’ may be flat, concave or convex and perpendicular to the bottom of the vessel, or it may be retracted inwards and, less frequently, outwards so that the diameter of the edge of the vessel is less than the diameter of the thickening/rib. All bowls have a footring. A large number of finds revealed numerous variations of the basic shape and large scale of sizes. Thus, for example, the most petite bowls have a diameter of about 15 cm, while the largest bowl found so far has an edge diameter of 35 cm (thickness of 37 cm) and a height of 14 cm (PI 2: 7). All pieces found were fired under reducing conditions and had a dark grey coating with a shine. Some pieces bear the slip only on the inside, while the outside is uncoated. Some specimens have the interior decorated with incised concentric circles, while most are undecorated. K. Adler-Wölfl associates this form with the Italian terra sigillata forms Consp. 33 and 34, respectively, in the Gallic form Drag. 24/25, noting that these Pannonian pieces are significantly larger than the terra sigillata “originals”. However, I would add that the only common element to these PSW forms and the sigillata mentioned above “prototypes” is this characteristic collared rim. The general impression of these PSW vessels, mainly because the Pannonian pieces are many times larger and more robust than terra sigillata bowls, calls into question that it is a question of applying terra sigillata forms to the new “medium”. I am more inclined to think that it is an original form. In any case, it seems that in Mursa, as in the rest of Pannonia, this is one of the most popular and longest-lived forms of PSW. The PSW study so far shows that this form’s use lasts as long as Adler-Wölfl established in Carnuntum, i.e. from the beginning of the 2nd century to the middle of the 3rd century (Adler-Wölfl 2004: 45-46).

In a somewhat smaller number, **jugs** appear in the repertoire of “colonial” PSW. In most cases, it is easy to distinguish the parts of the jug, but, as already mentioned, it is sometimes difficult to distinguish jugs from pots with a conical shoulder. Jugs occur in both firing variants, and it is difficult to determine for now whether red or grey jugs predominate. All specimens found have a conical neck and a trefoiled spout (PI 2: 12).

Cups. In contrast to the earlier period, a significant share in the colonial strata revealed many fragments of cups/goblets, similar to those published by Adler-Wölfl from Carnuntum. Almost all variants found on Carnuntum are present in Mursa, i.e. cups with conical and cylindrical shoulders, with the undecorated and ribbed body (Adler-Wölfl 2004: 49-51). Such shapes are identical to cups and pots that Alexandra Nagy published with PSW from Aquincum (Nagy 2014: Fig. 3, 6-7, 12-13). Therefore, the layers from Aelia Mursa show that the city was part of the same regional market with uniform products.

These forms form a kind of the core of the repertoire of PSW that lasts throughout the 2nd century. Many collected pieces show significant variations of these shapes. The colonial strata also revealed specimens of unique forms that we assume to be a one-time experiment in production or products made infrequently or relatively short-lived. The study of the material from the layers of the late 2nd and early 3rd centuries will soon make the story of the PSW from Mursa complete. It will be possible to compile a relatively credible typological-chronological table for this site. The systematisation of the material into styles and typological subgroups for the 2nd or 3rd century depends on answering some of the abovementioned questions. Dealing with pieces associated with previously defined ceramic groups is a problem. Their connection or affiliation to the PSW should be considered. While processing material from Mursa, all coated fragments are currently placed on the pile and processed as PSW findings or potential PSW fragments. One of such finds is the relief-decorated PSW spread throughout the Danube region. This pottery is defined as a local attempt to make a relief terra sigillata and fine tableware. Still, the question of the nature of these finds remains: local terra sigillata, imitation of relief terra sigillata, an authentic product inspired by imported relief terra sigillata. In any case, this includes the production of "Pacatus", so far considered a separate phenomenon, as a subgroup of PSW, i.e., including all local attempts to make terra sigillata in the 2nd century in this regional group.

CONCLUDING REMARKS

The paper relies on the Conspectus model approach, so the material is divided by forms, taking into account variations of basic shapes and services. The material is divided into chronologically and contextually conditioned typological subgroups. I decided to use the term style, taking into account the origin of the established forms. The division into stylistic groups is the fundamental division of the PSW from Osijek, aiming to expand to the broader region.

However, I would like to point out that sorting according to the origin of the form is not the only approach in processing PSW. There are other approaches. While processing the material from the pre-colonial cemetery, I noticed that vessels differ in the form of the bases, so it would be interesting to explore and re-examine the base design regardless of the shape of the entire vessel. The terra sigillata workshops from Italy and Gaul always used footrings for the base of vessels. There are almost the same number of PSW pieces from the pre-colonial cemetery of PSW specimens with footring and convex or flat bases without footring. The form of their bases is one of the reasons why these vessels cannot be considered local copies of the terra sigillata. The flat bottom denies one of the constituent typological elements of the form they should copy. The vessels would not have a flat bottom if they wanted to make faithful copies of terra sigillata, true to black or grey. The base on PSW is the element that makes this group authentic, even when they take on some features and shapes from imported ceramics. Considering that some parts of the vessel correspond to particular workshops' styles, while others deviate entirely, the possibility of division of PSW by styles should be regarded as problematic. These specimens, inevitably, are not imitations of imported terra sigillata. However, to find out where this authenticity comes from, it is crucial to solve why some vessels' bottoms are flat. That is why potters shaped such bases instead of all vessels having base modelled on terra sigillata.

Was shaping the base important to the potters at all? The current research level does not answer this question, but searching for this answer is one of the guidelines for further study. To start, one can reconsider which workshops use such base shaping. Given that the decisive influence on the emergence of the PSW came precisely through the imported terra sigillata, the view for resolving this issue goes to the eastern provinces, where the workshops made terra sigillata with just such bases. The thesis of Hungarian colleagues who saw the Oriental terra sigillata as a prototype for shaping concave-sided bowls of authentic style has already shown that influence from that part of the empire to Pannonia existed (Gabler et alii 2009, 65-69). A flat base is also a feature typical for some types of the Eastern Terra sigillata A (Hayes 57-60 and Hayes *forma tarda* e-f) and Eastern Terra sigillata B (Hayes 12-19 and Hayes 71-80). therefore, one of the answers may be the eastern terra sigillata, although the findings of this type of terra sigillata in Pannonia are almost negligible. One should ask whether it is possible that pottery, utterly invisible today among material remains from Pannonian settlements, exert such a strong influence on the formation of the PSW.

On the other hand, perhaps shaping the base is not a matter of style but technology. A flat base, and even one concavely made on a mould, is much easier to make than a footring, so using a flat bottom is simply a consequence of simplifying production. Thus, if it is a straight constructive (technological) element and not an element of style, then the whole idea of the influence of oriental style on the making of the PSW would be called into question. Thus, the flat bottom would be an authentic "invention" of Pannonian potters to simplify production, which would mean that shaping the bottom has nothing to do with the designed style and should be neglected in processing findings. Perhaps the best confirmation would be a sample of the Italian-style PSW. Namely, the body of all vessels was made in Italian style, while some have footring characteristic of Italian terra sigillata, but others have concave or flat bases.

Defining the elements of one style and excluding those which are not is crucial in the practical part of dealing with pottery, i.e. they are the basis for the typological classification of the material. Yet, we deal with fragments rather than the entire vessel in most cases. For purely practical reasons, I think it would be good to insist on styles, i.e., finding regularities in PSW forms and grouping them into services. Let's upgrade and adapt to local forms according to the service system made by S. Zabelicky-Scheffenegger. Still, some elements, such as bottoms, should be excluded from processing because they go beyond style. Therefore, some typological features could be associated with a particular style or service. At the same time, some could be ignored because they have nothing to do with a specific type but are purely a consequence of technological deficits or simplification of production. I wanted to point out that this could be a guideline in studying the PSW finds with this paper. Such specific services and styles make possible the classification of PSW in more simple and precise subgroups, therefore a valuable tool for material processing. Also, these subgroups can be elements in compiling a complete story about Pannonian pottery production that could finally lead to broader or higher conclusions on Pannonian society and economy.

The problem in processing the PSW is also the overlap of typological groups. While processing material from the pre-colonial cemetery, a problem occurred with ceramic cups OS-TRG 08 – SF 3936, OS-TRG 08 – SF 3967, OS-TRG 08 – SF 4250 and OS-TRG 08 – SF 4645 (Figure 2). These cups gave an oval body with everted strip rim, with sides 3 mm thick, and a footring. These elements define these cups as local examples of thin-walled ceramics of the 2nd century. On the other hand, they are PSW in terms of appearance and consistency of coating. A kind of double identity of these cups opens another question that may be crucial in determining and processing PSW: "What kind of coating is the determinant of Pannonian slipped ware?". Pavić and Adler Wölfel took a polished coating as an essential feature of PSW. Therefore, should the slip's appearance, quality, and finishing be the main determinants in determining whether a piece of PSW or not? If the answer is yes, then a precise coating classification should be the primary tool in processing the material. A specific basis in this regard still exists. J. Istenič made the ground based on a group she defined as imitation terra sigillata, in a way "a PSW before PSW". Istenič opted for only two types of coatings, oxidation (F7) and reduction (F8). However, in the discussion, she stated that these two basic types of coating vary in quality and appearance (Istenič 1999: 88, 91-102). Of particular importance for understanding, PSW is the appendix to the book on material from Ptuj. According to archeometry, it is



Fig. 2 Ceramic cups (OS-TRG 08 – SF 3936, OS-TRG 08 – SF 3967, OS-TRG 08 – SF 4250 and OS-TRG 08 – SF 4645) are difficult to determine: examples of local thin-walled ceramics or cups PSW? (photo by T. Leleković)

evident that relatively small differences in firing temperature can create a wide range of ceramic and coating colours (Daszkiewicz, Schneider: 1999). K. Adler-Wölfel took a step further by defining four types of coatings on reduction-baked pieces, taking into account their colour (from light grey to black) and “finishing” (gloss or matte). She did not elaborate the coatings from the oxidised baked pieces in the same way but listed only one form of red coating (Adler Wölfel 2004: 28-29).

The coating on PSW from Mursa varies from black and dark grey through grey, yellow and red shades. During the processing of the finds from the graves, the bowl marked 106.1 proved to be particularly interesting. It is a fragmented bowl of the Italian style Service B found in a bustum-type grave, which proved extremely interesting because each fragment had its taphonomic path (Figure 3). Although it indeed had a black/dark grey coating, the exact original appearance of that coating cannot be determined. Due to the bonfire heat exposure, the fragments changed their appearance. Some have changed it drastically so that the fracture has a yellow/light pink colour and the coating an orange colour, suggesting that this fragment is part of a vessel burned under oxidising conditions. Some pieces changed the properties to a lesser extent, but the point is that pieces of the same vessel were in the same grave, but they differ in appearance significantly. This vessel pointed out the need for caution in determining the coating, and describing the method of baking PSW for secondary burning is an often overlooked phenomenon. It is frequent in cremation graves, but it is undoubtedly an element to consider when processing material from settlement and waste layers/pits.



Fig. 3 Photography of a Italian-style PSW cup damaged by secondary burning SF 106.1. (photo by T. Leleković)

The primary palette of coatings was determined on the findings of the PSW from the pre-colonial cemetery: dark grey / black coating, light grey coating, red coating and yellow-ocher coating. Furthermore, the coating does not have a uniform quality or a uniform “finishing”. High-quality “hard” coatings, very similar to terra sigillata, have a “gloss” or “matte” finish. In contrast, some pieces have a “soft” coating with a weak consistency that peels or rashes. In some cases, “soft” coating show that they have been exposed to high temperatures so that they may have originally had a “hard” coating, but the coating may have changed consistency due to secondary burning. Fortunately, pieces with no traces of secondary exposure to high temperatures were found but still have the same “soft” coating. Therefore, slip differs by consistency keeping in mind that the present state is not authentic. According to these findings, a palette of PSW coatings from Mursa consists of four primary coating colours and three forms of “finishing” (Fig. 3).

Interestingly, burning can be directly related to the particular style in the pre-colonial cemetery, with some exceptions. All examples of PSW Italian style were burned under a reduced atmosphere. Only two examples of Gaulish style were burned under an oxidising atmosphere, while dishes of authentic style were burned under both oxidising and reduced atmosphere. A more detailed elaboration of the appearance of the coating is currently possible only at the PSW of the

















	shiny slip	mat slip	"corse slip"	damaged
black / darkgrey				
grey				
red				
yellow				

Fig. 4 Table of the colour palette of PSW coatings from Mursa. (photo by T. Leleković)

Italian style due to the number of findings of that subgroup. At the beginning of the PSW study, it seemed logical that the vessels of a particular service should have the same slip, but the material from the graves showed that this was not the case (Figure 5). For example, a dish of service A has the same grey coating and a vessel of service D that bears the seal of master Marius, even though they are parts of different services. At the same time, a dish made in Italian style service A bearing the same Marius seal, found in Ptuj, is red slipped burned under reducing conditions. An Italian style dish and an authentic



Fig. 5 Photograph of the PSW from the pre-colonial cemetery of Mursa. Examples of two primary coating forms: on the left dish and bowl with grey gloss slip, on the right dish and bowl with black gloss coating. (photo by T. Leleković)

bowl carry a hard black coating with a distinct shine. So obviously, the choices between the style of shaping and baking and finishing were not related. At this point, the PSW database is too small to allow a theory to be created about how potters choose to paint and “finishing” coatings. Therefore, we should not discard conclusions of the study on the material from the pre-colonial cemetery. On the first level, it is necessary to include vessels in good and excellent condition that can be considered the original appearance of the vessels. The complete dominance of reduction-baked vessels is apparent, but it is not sure that this is a general rule in Mursa of that time. Without comparative material from the settlement, it is possible that burial customs conditioned the choice of pottery used for grave goods. The pre-colonial cemetery is the only sample from that particular period in Mursa. Although it isn't maybe a representative sample, it is the only one.

The second level of the problem consists of poorly preserved vessels, especially those damaged by fire. Namely, the coating range includes a “soft” coating that peels easily due to some pieces. It is impossible to determine whether this “softness” results from poor firing and is inherent in these pieces or whether they had a “hard” coating. Still, it lost its original properties due to secondary burning. There is a possibility that the vessels on the bonfire were exposed to a uniform temperature. There were no traces of secondary burning, as is the case on the pieces where this exposure was inconsistent. For the time being, it is not possible to distinguish for such examples whether this is their original appearance or a consequence of “uniform secondary burning”.

The third line of research concerns the size and volume of PSW vessels. Still, as I have nothing new to write on this topic, I would refer to my article on the relationship between PSW and terra sigillata published a few years ago. It is necessary to explore this direction of research because the size of the vessels is standardised. For more significant progress in this regard of research, it is essential to enrich the database, both with the findings of PSW and terra sigillata, so that the results of such a study are valid (Leleković 2018).

CONCLUSION

In the last twenty years, several excavations of Mursa unearthed dozens of well-defined archaeological sites (contexts) that showed how historical events made Mursa one of the best sites in Pannonia to study 2nd-century Roman material culture thus for the study of the PSW. Namely, numerous contexts have origin defined within several decades. It is imperative to state that some contexts are parts of the same stratigraphic sequence are in addition to others with their relative stratigraphy to the sequence. A significant amount of PSW from Mursa can derive from such dated stratigraphic units from the late 1st century to the 3rd century.

The current study showed that the PSW in Mursa derives from two “production lines”. One production line relies on the forms taken from imported terra sigillata. Some specimens are fair imitations using sigillata shapes as prototypes from the bottom up to body and decoration. Although, vessels that imitate terra sigillata in finishing, i.e. vessels with shiny red coating, are exceptional. Only such samples can be considered imitations/copies of terra sigillata.

On the other hand, some vessels are burned under reduction conditions and have a grey or black coating, with or without glare, have a shape that sometimes completely copies the terra sigillata. Other specimens have only some typological elements of the terra sigillata. Such samples can be said to be imitations of terra sigillata in a broader sense, so these products imitate some aspects of terra sigillata without the intention of copying them.

The main problem related to the first production line is the resolved questions: “Copying or imitating sigillata?”. In informal conversations with colleagues, I have repeatedly defended using the word imitation in my work on the PSW for the collection “Big Data on the Roman Table” (Leleković 2018). But, I must point out that this article intended to explore the nature of PSW primarily as a local form of imitation terra sigillata in southern Pannonia, full aware of the dubiousity of the word “imitation”. I realised that some words could have multiple meanings or interpretations in these discussions. One particular word does not mean the same to all people. In the Croatian language, to imitate means to make a conscious effort to do what others do, follow the example of someone else, and imitate. It is essential to add another question to this rather vague definition when studying the production of consumer goods or works of art. The intention when replicating a particular prototype or form is fundamental. It is not the same whether it is produced as a forgery for sale under the pretention that it is an original. Or, is something authentic product made without intention to be sold as an original. So, it makes a big difference whether something is a counterfeit or a genuine product that only follows a particular style or fashion visible on imported “global” goods. Considering the problem thus posed, it is clear that potters who made PSW predominantly did not intend to create forgeries of terra sigillata. They were making authentic products that imitated a particular style. So, when I describe PSW in the text as an imitation of terra sigillata, I have in mind primarily the use of a style from terra sigillata. I find it unnecessary to emphasise the obvious, PSW is an authentic Pannonian product part of

a broader story. Namely, C.M. Wells wrote in the *Conspectus*: "There are cases where sigillata influenced native potters, without their trying actually to imitate it.", describing a phenomenon where the influence of terra sigillata on shaping is not the same as imitating / copying terra sigillata. Thus, PSW is only a part of a large family of local ceramic groups that existed alongside terra sigillata influenced by terra sigillata, a local product for the local market (Leleković 2018).

The second production line of PSW includes all those products that are not shaped in the forms of the terra sigillata model, including those for which it is not possible to determine the exact origin of their form and those indeed made in authentic local forms. Also, it is essential to add that some authentic forms have their source in "native" Pannonian shapes having La Tène origins. At the same time, some originated as new inventions of Pannonian workshops of the 1st and 2nd centuries.

Both production lines last from the second half of the 1st century to the 3rd century. The pottery study from Mursa did not yet reveal exact chronological stages of PSW development; still, both production lines show certain chronological regularities.

How to continue the PSW study? First, it is necessary to make a catalogue of PSW forms modelled on *Conspectus*. Both, mass-produced forms, with all their variations in design and majority, and those forms that appear sporadically, probably the individual attempts of particular potters. Second, those mass-produced forms that have become the standard repertoire of the PSW should be compared with each other and see if they can fit into the Service as S. Zabehllicky-Scheffenegeer did for Tardo-Padana. Third, such defined services and forms need to be considered diachronically and see if there are development phases of PSW, i.e., regionally conditioning. Fourth, it is necessary to standardise the palette of coatings and connect it with typology, chronology and spatial analysis of findings. I hope that this article has laid the foundation and paved the way for the transformation of the PSW into an excellent tool for studying local material culture and a first-class dating tool, which would elevate this ceramic group to the very top of Roman provincial archaeology of Pannonia. It is still a long way to go.

CATALOGUE

Plate 1

Cup. OS-TRG 08 - PN 4743. PSW of Italian style made in the form of Consp. 43. A rounded body with a hooked rim. The interior is decorated with two incised lines. The bottom is flat, profiled with a groove. Secondary burning damaged the cup, making it difficult to determine the original colour and slip.

Colour: Light grey clay (M GLEY 6 / N), dark grey coating (M GLEY 2 2.5 / 5 PB).

H. 20 mm, Diam. 70 mm.

Dating of context: 80 - 133 AD.

Place of discovery: Trg bana Josipa Jelačića, grave 278.

Literature: Consp. 43.1, Istenič 1999, PTS 7.1.2, Brukner 1981, T. 72 / 28-29, 36.

Bowl. OS-TRG 08 - PN 5294. PSW of Italian style made in the form of Consp. 43. A rounded body with a hooked rim. The interior is decorated with an incised line. The bottom is flat, profiled with a groove. Secondary burning damaged the cup.

Colour: Grey clay (M. GLEY 6 / N), grey gloss coating (M. GLEY 2 2.5 / 5 PB).

H. 47 mm, Diam. 154 mm.

Dating of context: 80 - 133 AD.

Place of discovery: Trg bana Josipa Jelačića, grave 263.

Literature: Consp. 43.1, Istenič 1999, PTS 7.1.1.

Bowl. OS-TRG 08 - PN 4280. PSW of Italian style made in the form of Consp. 43. A rounded body with a hooked rim. The interior is decorated with a line. A footring with the thickened central part.

Colour: grey clay (M. GLEY 1 7 / N), grey clay with reflection (M. GLEY 1 2.5 / N).

H. 47 mm, Diam. 160 mm.

Dating of context: 80 - 133 AD.

Place of discovery: Trg bana Josipa Jelačića, grave 278.

Literature: Consp. 43.1.2, similar: Istenič 1999, PTS 7.1.

Bowl. OS-TRG 08 - PN 3773. PSW of Italian style made in the form of Consp. 43. A rounded body with a hooked rim. The interior is decorated with two incised lines. Ring bottom.

Colour: secondary combustion changed the export appearance of the pelvis, light brown clay (M. 7.5YR 6/3), red coating (M. 2.5YR 5/8).

H. 50 mm, Diam. 140 mm.

Dating of context: 80 - 133 AD.

Place of discovery: Trg bana Josipa Jelačića, grave 278.

Literature: Consp. 43.1.2, similar: Istenič 1999, PTS 7.1.

Bowl. OS-TRG 08 - PN 2450. PSW of Italian style made in the form of Consp. 44. A rounded body with a horizontal rim. The rim bears a decoration of one incised line at the upper side and one at the downside.

Colour: secondary combustion changed the export appearance of the pelvis, brownish-red clay (M. 7.5 YR 7/4), red coating (M. 2.5 YR 6/8).

H. 43 mm, Diam. 166 mm.

Dating of context: 80 - 133 AD.

Place of discovery: Trg bana Josipa Jelačića, grave 106.

Bowl. OS-TRG 08 - PN 2011064. PSW of Italian style made in the form of Consp. 44. A rounded body with a horizontal rim that is slightly deflecting downward. Flat bottom profiled with groove.

Colour light grey clay (M. 7.5 YR 7/6).

H. 39 mm, Diam. 160 mm.

Dating of context: 80 - 133 AD.

Place of discovery: Trg bana Josipa Jelačića, grave 189.

Literature: Consp. 43.1.2, similar: Istenič 1999, PTS 7.1.

Bowl. OS-TRG 08 - PN 4364. PSW of Italian style made in the form of Consp. 32. A rounded body with a restricted body. Rim is simple, on the inner side decorated with two incised lines. Footring with the thickened central part. Secondary burning damaged the cup, so it is impossible to determine the original colour.

H. 57 mm, Diam. 170-180 cm.

Dating of context: 80 - 133 AD.

Place of discovery: Trg bana Josipa Jelačića, grave 297.

Bowl. OS-TRG 08 - PN 2732. PSW of Italian style made in the form of Consp. 45. A rounded body with a flat rim and raised edge. The rim is decorated on the upper side with rouletting and an incised line. Evenly formed footring. In the centre of the interior, the bowl bears the "*in planta pedis*" stamp "MARIVS".

Colour: light grey clay (M. 10YR 6/1), grey coating with gloss (M. 10YR 4/1).

Dating of context: 80 - 133 AD.

Place of discovery: Trg bana Josipa Jelačića, grave 103.

Literature: Consp. 45.1.1; stamp: Istenič 1999, 102.

H. 49 mm, Diam. 130 mm.

Dish. OS TRG 08 - PN 5214. PSW of Italian style made in the form of Consp. 39. A rounded body with a hooked rim. The rim bears decoration is made of faceting. The bottom is flat with an incised groove, giving the appearance of a footring. While the vessel was turning, the potter made an incised line on the outside and inside, just below the rim. Additionally, the interior surface bears three concentric circles made using a stylus, probably while the vessel was not turning, because lines are irregular. Colour: grey clay (M. 5YR 6/1), dark grey coating (M. 2.5 Y 3/1).

H. 33 mm, Diam. 200 mm.

Dating of context: 80 - 133 AD.

Place of discovery: Trg bana Josipa Jelačića, grave 396.

Literature: Consp. 39. Istenič 1991. PTS 10.1.2.

Dish. OS-TRG 08 - PN 4621. PSW of Italian style made in the form of Consp. 39. A rounded body with a hooked rim and a footring. Just below the edge, the inside is decorated with an incised line. The interior surface bears a decoration of a wide circular ribbon made of rouletting in the centre of which the dish bears a stamped decoration made of leaf motif. On the outside, the body is decorated with an incised line.

Colour; grey clay (M. 5YR 6/1) with a dark grey coating (M. 5YR 6/1).

H. 34 mm, Diam. 152 mm.

Dating of context: 80 - 133 AD.

Place of discovery: Trg bana Josipa Jelačića, grave 318.

Literature: Consp. 39. Istenič 1991. PTS 10.2, Nikolić-Đorđević 2000, Type III / 41.

Dish. OS-TRG 08 - PN 3643. PSW of Gaulish style made in the shape Drag. 18/31. A rounded body with a thickened rounded rim. The bottom is concave with a thickened centre. Inside, the dish bears an incised horizontal line just below the edge, and the decoration of circular ribbon is made rouletting in the centre. The body outside carries an incised horizontal line.

Colour: yellow clay (M. 7.5 YR 7/4), light brown coating (M. 7.5 YR 5/6).

H. 50 mm, Diam. 280 mm.

Dating the context of the findings: 80 - 133 AD.

Place of discovery: Trg bana Josipa Jelačića, grave 241.

Bowl. OS-TRG 08 - PN 3630. PSW of Gaulish style made in the shape Drag. 37. A rounded body with a simple rim. The body on the outside bears two incised grooves below the rim and two ribbons made with rouletting on the inside of the body, just a simple incision on the edge of the rim. Profiled footring with thinned bottom in the centre.

Colour: Pink clay (5YR 7/3) 7 red coating made with imitation "eponge-technique" (M.2.5 YR 4/8).

H.75 mm, PrR.190 mm.

Dating of context: 80 - 133 AD.

Place of discovery: Trg bana Josipa Jelačića, grave 241.

Concave-sided bowl. OS-TRG 08 - PN 3941. PSW of authentic style. A concave sided body with thickened bowelled rim and a sharp transition between the body and the bottom. The bottom is concave.

Colour: Grey clay (M. GLEY 1 4 / N), black glossy coating (M. Gley 1 4 / N).

H.38 mm, Diam. 118 mm.

Dating of context: 80 - 133 AD.

Place of discovery: Trg bana Josipa Jelačića, grave 118.

Concave-sided bowl. OS-TRG 08 - PN 2733. PSW of authentic style. A concave sided body with thickened bowelled rim and a sharp transition between the body and the bottom. Footring with thickened base in the centre. Inside bears an incised horizontal line just below the rim.

Colour: Grey clay (M. GLEY 1 4 / N), black glossy coating (M. Gley 1 4 / N).

H. 61 mm, PrR.140 mm.

Dating of context: 80 - 133 AD.

Place of discovery: Trg bana Josipa Jelačića, grave 103.

15. Concave-sided bowl. OS-TRG 08 - PN 5181. PSW of authentic style. A concave sided, almost flaring sided body, with a sharp transition between the body and the bottom. Footring with a concave base. Excellent artistry.

Colour: Grey clay (M. GLEY 1 4 / N), black glossy coating (M. Gley 1 4 / N).

H. 45 mm, Diam. 162 mm.

Dating of context: 80 - 133 AD.

Place of discovery: Trg bana Josipa Jelačića, grave 364.

Shallow bowl. OS-TRG 08 - PN 5370. PSW of authentic style. A rounded body The bowl has a wide concave body. It is decorated on the outside with an incised line. Shallow annular bottom profiled with a groove on the inside and slightly raised in the middle. The interior is decorated with a wreath made of feathers and printed vegetable ornaments. Just below the lip of the plate, on the inside, two lines are incised.

Colour: light grey clay (M. 10YR 6/1), grey coating with gloss (M. 10YR 4/1).

H. 67 mm, Diam. 244 mm.

Dating the context of the findings: 80 - 133 AD.

Place of discovery: Trg bana Josipa Jelačića, grave 409.

Shallow bowl. OS-TRG 08 - PN 4642. PSW authentic style. The bowl has a wide concave body on the outside decorated with two incised lines. The middle of the belly is decorated with two incised lines. Shallow cylindrical foot profiled on the underside with a groove slightly raised in the middle. It is made of medium refined clay.

Colour: Pink clay (5YR 7/3), red coating (M.2.5 YR 4/8).

H. 58 mm, Diam. 229 mm.

Dating of context: 80 - 133 AD.

Place of discovery: Trg bana Josipa Jelačića, grave 319.

Biconical pot. PSW authentic style. The pot has a biconical body where the pot is wider than taller. The rim is drawn outwards with the lip/rim of the square cross-section. It has a simple cylindrical foot slightly raised in the middle. Body bears decoration made of rouletting

Colour: grey clay (M. 7.5 YR 5/1), dark grey coating (M. 7.5 YR 3/1).

H. 145 mm, Diam. 108 mm, Belly 174 mm.

Dating of context: 80 - 133 AD.

Place of discovery: Trg bana Josipa Jelačića, grave 263.

Biconical pot. PSW authentic style. The pot has a biconical rounded body being taller than wider. The rim is drawn outwards with a simple lip. It has a simple cylindrical foot profiled with a groove on the underside. The coating is present to the upper half of the vessel, where the vessel bears decoration made of incised lines and rouletting.

Colour: Pink clay (5YR 7/3), red coating (M.2.5 YR 4/8).

H. 170 mm, Rim diam. 80 mm, Body diam. 135 mm.

Dating of context: 80 - 133 AD.

Place of discovery: Trg bana Josipa Jelačića, grave 409.

Plate 2

Concave-sided bowl. OS-TRG 08 - PN 2910. PSW of authentic style. The pelvis has a conical body, with a slightly concave body, the rim drawn outwards with an accentuated lip, and a sharp transition between the body and the bottom. Shallow annular leg raised upwards in the middle and profiled with a groove on the underside.

Colour: Grey clay (M. GLEY 1 4 / N), black glossy coating (M. Gley 1 4 / N).

H.30 mm, Diam. 110 mm.

Dating of context: 133 AD - middle of the 2nd century.

Location: Trg bana Josipa Jelačića, waste layer SJ 1212.

Concave-sided bowl. PSW authentic style. The pelvis has a conical body, straight outwards, and a sharp transition between the body and the bottom. The rim is pulled horizontally outwards with the rim slightly pulled up so that the edge is profiled—a shallow annular base.

Colour: Grey clay (M. GLEY 1 4 / N), black glossy coating (M. Gley 1 4 / N).

H. 53 mm, Diam. 164 mm.

Dating of context: 133 AD - middle of the 2nd century.

Location: Park kraljice Katarine Kosače. 1. horizon of the colony

Dish. PSW of Italian style made in the form of Consp. 39. An incision line profiles the interior in the upper part of the body. Flat bottom profiled with incised groove.

Colour: Grey clay (M. GLEY 1 4 / N), black glossy coating (M. Gley 1 4 / N).

H. 192 mm, Diam. 260 mm.

Dating of context: 133 AD - middle of the 2nd century.

Location: Park kraljice Katarine Kosače. 1. horizon of the colony.

Collared bowl. Rim fragment of a bowl. A collar is made inside a convex rim turned inwards with a simple rounded edge.

Colour: Grey clay (M. GLEY 1 4 / N), black glossy coating (M. Gley 1 4 / N).

Diam. 140 mm.

Dating of the context of the finds: 133 AD - middle of the 2nd century.

Location: Trg bana Josipa Jelačića, waste layer SJ 1212.

Collared bowl. Rounded body. The lower part of the body with straight sides turn outwards, forming an obtuse angle with the base. A collar is made inside a convex rim turned inwards with a clubbed edge—flat bottom with an acute-angled footring. The bowl bears the decoration of two incised lines on the inside and outside the body.

Colour: Grey clay (M. GLEY 1 4 / N), black glossy coating (M. Gley 1 4 / N).

H. 140 mm, Diam. 260 mm.

Dating of context: 133 AD - middle of the 2nd century.

Location: Park kraljice Katarine Kosače. 1. horizon of the colony.

Collared bowl. Rounded body. The lower part of the body with straight sides turn outwards, forming an obtuse angle with the base, although the lower part of the side is slightly concave. A collar is made inside a convex rim turned inwards with a clubbed edge—flat bottom with an acute-angled footring. The bowl bears the decoration of two incised lines on the inside and outside the body. In appearance similar to bowl no. 5, but significantly more prominent.

Colour: Grey clay (M. GLEY 1 4 / N), black glossy coating (M. Gley 1 4 / N).

H. 140 mm, Diam. 230 mm.

Dating of context: 133 AD - middle of the 2nd century.

Location: Park kraljice Katarine Kosače. 1. horizon of the colony.

Collared bowl. Biconical body. The lower part of the body with flaring sides forms an obtuse angle with the base. A collar is made on the upright rim turned slightly outwards with a clubbed edge—flat bottom with an acute-angled footring. The bowl bears the decoration of two incised lines on the inside.

Colour: Grey clay (M. GLEY 1 4 / N), black glossy coating (M. Gley 1 4 / N).

H. 60 mm, Diam. 355 mm.

Dating of context: 133 AD - middle of the 2nd century.

Location: Park kraljice Katarine Kosače. 1. horizon of the colony.

Bowl. Rim fragment of a PSW of Gaulish style made in the shape of Drag. 37. Rounded body with a thickened rounded rim. Body on the outside bears decoration made of rouletting.

Colour: Grey clay (M. GLEY 1 4 / N), black glossy coating (M. Gley 1 4 / N).

Diam. 200 mm.

Dating of context: 133 AD - middle of the 2nd century.

Location: Park kraljice Katarine Kosače. 1. horizon of the colony.

Bowl. Body fragment of a PSW of Gaulish style made in the shape of Drag. 37. Sides and footring are unusually thick—rounded body with upright sides in the upper part. The body on the outside bears a decoration made of incised groove and rouletting.

Colour: Grey clay (M. GLEY 1 4 / N), black glossy coating (M. Gley 1 4 / N).

H. 90 mm. Diam. 185 mm.

Dating of context: 133 AD - middle of the 2nd century.

Location: Park kraljice Katarine Kosače. 1. horizon of the colony.

Bowl. Rim fragment of a PSW of Gaulish style made in the shape of Drag. 37. Rounded body with a clubbed rim.

Colour: Grey clay (M. GLEY 1 4 / N), black glossy coating (M. Gley 1 4 / N).

Diam. 300 mm.

Dating of the context of the finds: 133 AD - middle of the 2nd century.

Location: Park kraljice Katarine Kosače. 1. horizon of the colony.

Bowl. Body fragment of a PSW of Gaulish style made in the shape of Drag. 37. Rounded body with a thickened rounded rim. The body on the outside bears decoration made of stamped rectangular patterns and "eierstab" in the upper part, imitating relief decoration of this type of Gaulish bowl.

Colour: Grey clay (M. GLEY 1 4 / N), black glossy coating (M. Gley 1 4 / N).

Diam. 280 mm.

Dating of context: 133 AD - middle of the 2nd century.

Location: Park kraljice Katarine Kosače. 1. horizon of the colony.

Jug. OS-KAMP 19 - 336.1 Jug with a conical neck and rounded belly. The mouth of the jug is shaped in the shape of a trefoil with a pronounced outflow. The junction of the neck and abdomen is accentuated with the rim. The bottom is flat and simply shaped.

Colour: Grey clay (M. GLEY 1 4 / N), black glossy coating (M. Grey 1 4 / N).

H. 190 mm, Diam. About 60 mm.

Dating of context: the second half of the 2nd century.

Location: Kampus, SU 336.

BIBLIOGRAPHY

- Adler-Wölfl, K. 2004, *Pannonische Glanztonware aus dem Auxiliarkastell von Carnuntum: Ausgrabungen der Jahre 1977-1988*, Vienna: Österreichisches Archäologisches Institut. https://doi.org/10.26530/OAPEN_477713
- Arveiller-Dulong, V. i Nenna, M.-D. 2005, *Les verres antiques du Musée du Louvre II, Vaisselle et contenants du Ier siècle au début du VIIe siècle après J.-C.*, Paris.
- Baćani, I., Škrkulja, R., Tomaš-Barišić, T., Gospodinović, S., 2011, Archaeological conservation research of the City museum Sisak since 2000. until 2010. Gradski muzej Sisak, Sisak.
- Božič, D. *Late La Tène-Roman cemetery in Novo mesto: Ljubljanska cesta and Okrajno glavartvo: studies on fibulae and on the relative chronology of the Late La Tène period*, Katalogi in monografije 39, Narodni muzej Slovenije, Ljubljana.
- Brukner, O. 1981, *Rimska keramika u Jugoslovenskom delu provincije Donje Panonije*, Dissertationes et Monographie 24, Beograd.
- Brulet R., Vilvorder F. & Delage R. (eds.) 2010 *La céramique romaine en Gaule du Nord. Dictionnaire des céramiques. La vaisselle à large diffusion*, Brepols, Turnhout.
- Dannell, G.B. 2006, 'Samian cups and their uses' in R.J.A. Wilson (ed) *Romanitas: Essays on Roman Archaeology in Honour of Sheppard Frere on the Occasion of his Ninetieth Birthday*, 1st Edition. Oxford: Oxbow Books. 147-76.
- Dannell, G.B. 2012, "The origins of the samian form Dragendorff 37: "The weight of the evidence"" in D. Bird (ed) *Dating and Interpreting the Past in the Western Roman Empire. Essays in honour of Brenda Dickinson*, Oxford: Oxbow Books. 58-69.
- Dannell, G.B. 2018, 'The Uses of South Gaulish Terra Sigillata on the Roman Table. A study of nomenclature and vessel function', *Internet Archaeology* 50. <https://doi.org/10.11141/ia.50.5>
- Daszkiewicz, M. I., Schneider, G. 1999., Chemical, mineralogical and technological studies of fabrics of Roman vessels and lamps from Poetovio, u: J. Istenič, Poetovio, The western cemeteries I. Grave-groups in the Landesmuseum Joanneum in Graz, Katalogi in monografije 32, Ljubljana: Narodni muzej Slovenije.
- Delage, R. 2010, 'La sigillée de La Graufesenque' in R. Brulet, F. Vilvorder and R. Delage (eds) *La céramique Romaine en Gaule du Nord*, Turnhout: Brepols. 60-86.
- Dizdar, M. 2001, *Latenska naselja na vinkovačkom području: tipološko-statistička obrada keramičkih nalaza*, Zagreb.
- Dizdar, M. 2013, *Zvonimirovo veliko polje, Groblje latenske kulture*, vol. 1, Zagreb.
- Dragendorff, H. 1895, *Terra sigillata: ein Beitrag zur Geschichte der griechischen und römischen Keramik*, Bonner Jahrbücher, 96/97, Bonn.
- Drnić, I. (ed.) 2018, *Segestika i Siscija – od ruba Imperija do provincijskog središta*. Zagreb, Arheološki muzej u Zagrebu.
- Ettlinger, E., Hedinger, B., Hoffmann, B., Kenrick, P.M., Pucci, G., Roth-Rubi, K., Schneider, G., Schnurbein, S. Von, Wells, C.M. and Zabeňlicky-Scheffenecker, S. 1990, *Conspectus Formarum Terrae Sigillatae Italico Modo Confectae*, Bonn: Rudolf Habelt.
- Fasold, P. 2006, *Die Bestattungsplätze des römischen Militärlagers und Civitas-Hauptortes Nida (Frankfurt am Main -Heddernheim und -Praunheim)*, Schriften des Archäologischen Museums Frankfurt 20. Frankfurt am Main: Schnell & Steiner.
- Gabler, D. 1982, 'Die südgallischen Sigillata in Pannonien. Einige Besonderheiten ihrer Verbreitung', *Rei Cretariae Romanae Favtorvm Acta* 21-22, 49-62.
- Gabler, D. 198,6 *Terra sigillata im Barbaricum zwischen Pannonien und Dazien*, Budapest: Akadémiai Kiadó.
- Gabler, D. 2003, 'L MAG() VIRI(lis), Un atelier tardo padano di terra sigillata', *Acta Archaeologica Academiae Scientiarum Hungaricae* 54, 81-100.
- Gabler, D., Hárshgyi, P., Lassányi, G. and Vámos, P. 2009, Eastern Mediterranean import and its influence on local pottery in Aquincum, *Acta Archaeologica Academiae Scientiarum Hungaricae* 60, 51-72. <https://doi.org/10.1556/AArch.59.2008.2.7>
- Gassner, V. 1993, Pannonische Glanztonware mit Stempelverzierung aus Carnuntum in B. Lamut (ed) *Ptujski arheološki zbornik ob 100-letnici muzeja in Muzejskega društva*, Ptuj: Zgodovinsko društvo Ptuj. 359-83.
- Gregl, Z. 1989, *Rimskodobna nekropola Zagreb – Stenjevec*, Zagreb: Arheološki muzej Zagreb.
- Gregl, Z. 2003, Gornja Vas na Žumberku - grob 36. *Opuscula Archaeologica*, 27, 469-480.
- Gregl, Z. 2007, *Rimskodobna nekropola Gornja Vas na Žumberku*, *Vjesnik Arheološkog muzeja u Zagrebu* 40, 221-332.
- Hayes, J.W. 1972 *Late Roman Pottery*, London: British School at Rome.
- Hayes, J.W. 1985 'Sigillate orientali' in G. Pugliese-Carratelli (ed) *Atlante delle forme ceramiche 2. Ceramica fi ne romana nel bacino Mediterraneo (trado ellenismo e primo impero)*, Enciclopedia dell'arte antica classica e orientale, Rome: Istituto della Enciclopedia Italiana. 1-96.
- Horvat, J., Lovenjak, M., Dolenc Vičić, A., Lubšina-Tušek, M., Tomanič-Jevremov, M., Šubic, Z. 2003 'Poetovio. Development and topography' in M. Šašel Kos, P. Scherrer, B. Kuntić-Makvić and L. Borhy (eds) *The Autonomous Towns of Noricum and Pannonia: Pannonia I, Situla* 41. 153-190.
- Istenič, J. 1999, *Poetovio, The western cemeteries I. Grave-groups in the Landesmuseum Joanneum in Graz*, Katalogi in monografije 32, Ljubljana: Narodni muzej Slovenije.
- Kiss, K. 1938, *Die chronologische Reihenfolge der Fabrikate der Topfers Pacatus von Aquincum, in Laureae aquincenses, memoriae Valentini Kuzsinszky dicatae: aquincumi babérágak Kuzsinszky Bálint emlékének szenteli Budapest-székesfóváros közönsége és a Pázmány-egyetem Érem- és regiségtani intézete*, Dissertationes Pannonicae ex Instituto numismatico et archaeologico Universitatis de Petro Pázmány

- nominatae budapestinensis provenientes; ser. 2, nos 10-11, Budapest: Institut fuer munzekunde und archaeologie der P. Pázmány-Universitaet, Leipzig: O. Harrassovitz. 212-28.
- Kolšek, V. 1976, Vzhodni del antične nekropole v Šempetru, Katalogi in monografije 14, Ljubljana: Narodni muzej Slovenije.
- Kovács, P. 2014, *A History of Pannonia during the Principate*, Bonn: Rudolf Habelt.
- Leleković, T. 2008, Osijek – Trg bana Jelačića, Hrvatski arheološki godišnjak 5, 45-51.
- Leleković, T. 2012, *Antičke nekropole Siscije i Murse*, neobjavljeni doktorski rad, Zagreb: Sveučilišta u Zagrebu.
- Leleković, T. 2016, Local imitations of imported fine tablewares from Southern Pannonia; The production of the Flavian and post-Flavian period, *Rei Cretariae Romanae Favtorvm Acta* 44, 609-18.
- Leleković, T. 2018, How were Imitations of Samian Formed?, *Internet Archaeology* 50. <https://doi.org/10.11141/ia.50.18>.
- Leleković, T. 2020, Elija Mursa: Novo čitanje grada, *Arheol. rad. raspr.* 19 (2020), 77-161.
- Leleković, T. 2021, Regionalism in Southern Pannonia, Ad ripam fluminis Danuvi, Papers of the 3rd International Conference on the Roman Danubian Provinces Vienna, 11th–14th November 2015, F. Mitthof, C. Cenati and L. Zerbini, Tyche Supplementband 11, Beč. 251-278, Table 37–40.
- Lolić, T. 2003, Colonia Flavia Siscia, in: M. Šašel Kos, P. Scherrer, B. Kuntić-Makvić and L. Borhy (eds) *The Autonomous Towns of Noricum and Pannonia: Pannonia I, Situla* 41. 131-52.
- Makjanić, R. 1995, Terra sigillata, in R. Koščević and R. Makjanić, *Siscia, Pannonia superior: Finds and metalwork production. Terra sigillata*, British Archaeological Reports, Int. Series 621. Oxford: Tempus Reparatum. 43-83, plates 56-74.
- Maróti, É. 1987, Római kori pecsételt kerámia Nyugat-Pannoniában/Römerzeitliche gestempelte Keramik in Westpannonien, *Zalai Múzeum* 1, 81–103.
- Marton, A. 2008, Mobilier en terre sigillée dans les sépultures pannoniennes, *Communicationes Archaeologicae Hungariae* 2008, 135-89.
- Mikl-Curk, I. 1969, *Terra sigillata in sorodne vrste keramike iz Poetovija*, Beograd: Arheološko društvo Jugoslavije.
- Mócsy, A. 1974, *Pannonia and Upper Moesia. A History of the Middle Danube Provinces of the Roman Empire*, London, Boston: Routledge.
- Nagy, A. 2014, Forging samian ware in the Pannonian way: the case of stamped pottery, *Rei Cretariae Romanae Favtorvm Acta* 43, 119-27.
- Nikolić-Đorđević, S. 2000, Antička keramika Singidunuma, *Singidunum* 2, Beograd, 11-244.
- Ožanić Roguljić, I. 2016, *Tipologija rimske keramike iz Vinkovaca*, Zagreb.
- Passelac, M. and Vernhet, A. 1993. Céramique sigillée sud-gauloise, in M. Py, A.M. Adroher Auroux and R. Raynaud Dicocer: dictionnaire des céramiques antiques en Méditerranée nord-occidentale : VIIème s. av. n. è - VIIème s. de n. è., Provence, Languedoc, Ampurdan, Lattara 6, Lattes: Ed. de l'Association pour la recherche archéologique en Languedoc oriental. 569-580.
- Pavić, I. *Zum Formenspektrum der pannonischen Glanztonkeramik von Wien* 1, Michaelerplatz Grabungen 1990/91, Fundort Wien Berichte zur Archäologie 7/2004, 118-166.
- Petru S., Petru, P. 1978 Nevioudunum (Drново pri Krškem), Katalogi in monografije 15, Ljubljana: Narodni muzej Slovenije.
- Polak, M. 2000 South Gaulish terra sigillata with potters' stamps from Vechten, *Rei Cretariae Romanae Favtorvm Supplementum* 9, Nijmegen: Katholieke Universiteit Nijmegen.
- Vernhet, A. 1986 'Groupe de La Graufesenque: Centre de production de Millau: atelier de La Graufesenque' in C. Bémont, J-P. Jacob (eds) *La terre sigillée gallo-romaine: lieux de production du Haut Empire: implantations, produits, relations*, Documents d'archéologie française 6, Paris: Editions de la Maison des sciences de l'homme. 96-102.
- Wells, C.M. 1990, "Imitations" and the spread of sigillata manufacture, in: E. Ettliger, B. Hedinger, B. Hoffmann, P.M. Kenrick, G. Pucci, K. Roth-Rubi, G. Schneider, S. Von Schnurbein, C.M. Wells and S. Zabehtlicky-Scheffenecker, *Conspectus formarum terrae sigillatae italico modo confectae*, Bonn: Rudolf Habelt, 24-25.
- Zabehtlicky-Scheffenecker, S. 1990a, Terra sigillata Tardo-Padana in E. Ettliger, B. Hedinger, B. Hoffmann, P.M. Kenrick, G. Pucci, K. Roth-Rubi, G. Schneider, S. Von Schnurbein, C.M. Wells and S. Zabehtlicky-Scheffenecker *Conspectus formarum terrae sigillatae italico modo confectae*, Bonn: Rudolf Habelt. 16.
- Zabehtlicky-Scheffenecker, S. 1990b, Formen mit ausladendem Rand und Barbotineverzierung, in E. Ettliger, B. Hedinger, B. Hoffmann, P.M. Kenrick, G. Pucci, K. Roth-Rubi, G. Schneider, S. Von Schnurbein, C.M. Wells and S. Zabehtlicky-Scheffenecker *Conspectus formarum terrae sigillatae italico modo confectae*, Bonn: Rudolf Habelt. 49.

SAŽETAK
PANONSKA KERAMIKA S PREMAZOM IZ MURSE:
OSVRT NA TRENUTNU RAZINU POZNAVANJA

Ključne riječi: panonsko posuđe s premazom, panonska keramika, imitacije terrae sigillatae, Mursa, južna Panonija

Niz povijesnih događaja Mursu je učinio jednom od najboljih lokaliteta u Panoniji za proučavanje rimske materijalne kulture 2. stoljeća, pa samim tim i za proučavanje panonske keramike s premazom (PKP). U posljednjih je dvadeset godina na području antičkog grada Murse proveden niz istraživanja kojima su otkopani su deseci dobro definiranih arheoloških cjelina (konteksta) čiji se nastanak može datirati unutar nekoliko desetljeća. Do sada je prikupljena značajna količina PKP koja se može vremenski pratiti kroz takve cjeline od kasnog 1. stoljeća do početka 3. stoljeća.

Dosadašnja obrada građe pokazala je da se PKP u Mursi može pratiti kroz dvije linije. Jedna linija proizvodnje oslanja se na korištenu oblika kakvi se mogu vidjeti na uvoznoj sigilati. Naime, neki primjerci su oblikovani po uzorku na sigilatu, preuzimajući sve sastavne tipološke elemente, od dna do imitacije ukrasa na stjenkama. Primjerci koji načinom i finishingom imitiraju sigilatu, dakle crveni premaz s odsjajem, iznimni su. Samo se takve primjerke doista može smatrati imitacijama/kopijama sigilate. S druge strane neke posude su redukcijski pečene i imaju sivi ili crni premaz, s odsjajem ili bez, a oblikom nekad potpuno kopiraju sigilatu, a u neki imaju samo neke tipološke elemente sigilate. Za takve se primjerke može se reći da su imitacije sigilate u širem smislu, dakle ti proizvodi imitiraju neke aspekte sigilate bez namjere da ih kopiraju.

Glavni problem koje se vezuje uz prvu liniju proizvodnje, odnosi se na razriješene pitanja: „Kopiranje ili imitiranje?“. U našem jeziku, imitirati znači svjesnim nastojanjem činiti ono što drugi čine, činiti po uzoru na koga drugoga, oponašati. Ukoliko se ta prilično neodređena definicija prenese na proizvodnju potrošne robe ili izradu umjetničkih djela, mora se njoj dodati pitanje namjere oponašanja nekog uzora. Nije isto oponaša li se nešto s namjerom da se podvali pod original, ili se oponaša samo stil ili izgled nekog predmeta bez namjere da se podmetne pod original. Dakle, velika je razlika da li je nešto krivotvorina koja bi se trebala poturiti pod original ili autentičan proizvod koji samo prati određeni stil ili modu koja je vidljiva na uvoznoj globusnoj robi. Uzimajući u obzir tako postavljen problem, sasvim je jasno da nitko tko je izrađivao PKP nije stvarao krivotvorine sigilata, već je izrađivao autentične proizvode koji su imitali određeni stil. Dakle, kada u tekstu opisujem PKP kao imitaciju sigilate, govorim o imitiranju ili oponašanju stila sa sigilate. Dakle, PKP je samo jedna član velike obitelji lokalnih keramičkih grupa koje su postojale uz sigilatu i na koje je utjecala sigilata, ali one su bile lokalni proizvod za lokalno tržište.

Druga linija proizvodnje PKP obuhvaća oblike koji nisu nastali po uzoru na sigilata, bez obzira radi li se o primjercima za koje se ne može utvrditi jesu li rezultat imitiranja, ili je doista riječ o autentičnim oblicima. Dakle, proizvodi druge linije obuhvaćaju autentične oblike, s tim da neki oblici očito imaju latensko porijeklo, dok su neki autentični oblici nastali u panonskim radionicama 1. i 2. stoljeća.

Obje linije proizvodnje traju od druge polovice 1. stoljeća do najmanje početka 3. stoljeća. Obradom građe nisu utvrđene razvojne faze PKP u Mursi, no očito je da se u obje linije proizvodnje, tijekom stoljeće i pol trajanja ove keramičke grupe, neki oblici mogu kronološki odrediti. U ovom radu ocrtan je smjer istraživanja PKP obiju proizvodnih linija i prijedlog tipološke podjele.

Pl. 1

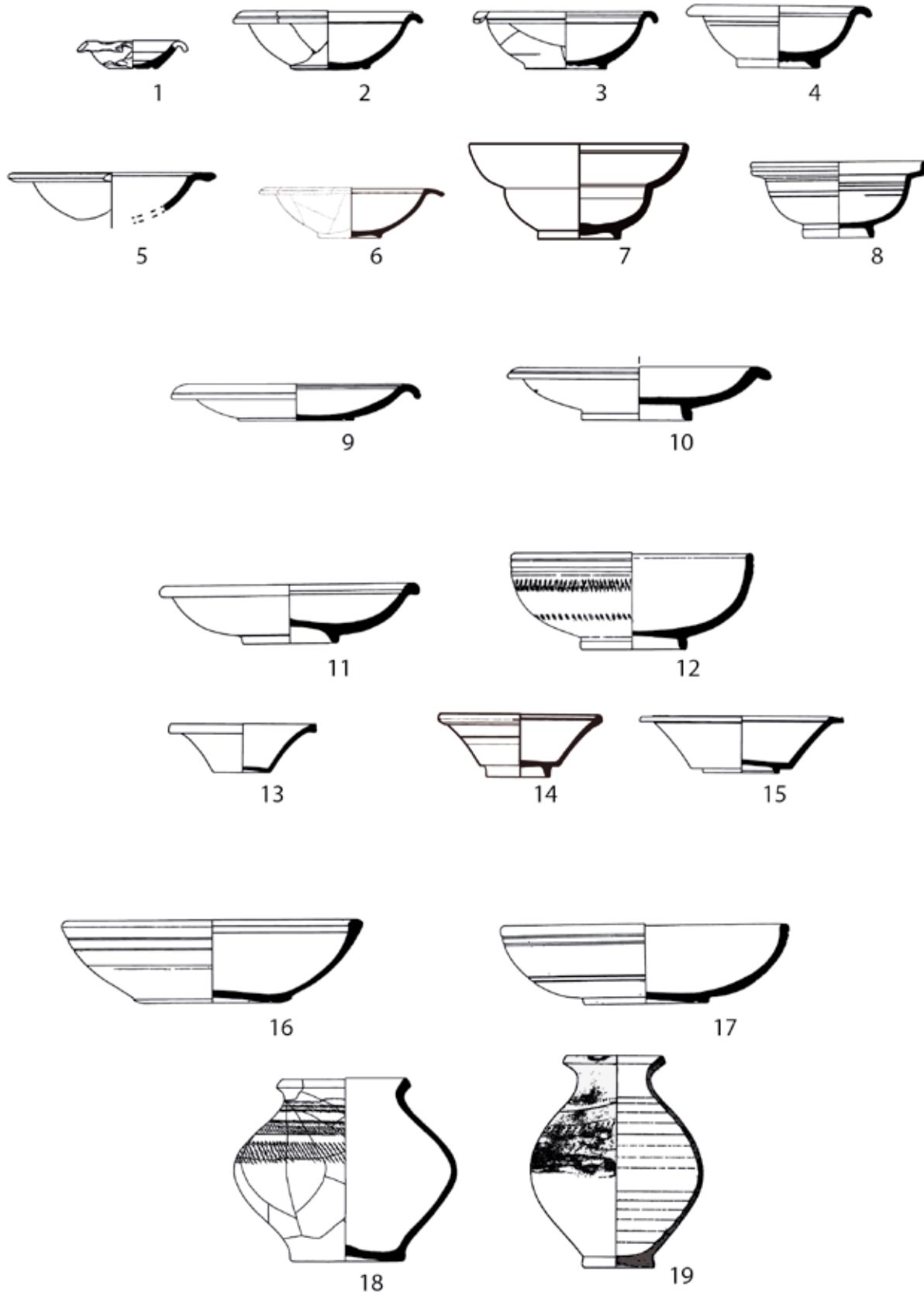

Plate 1 Pre-colonial phase (made by T. Leleković)

Pl. 2

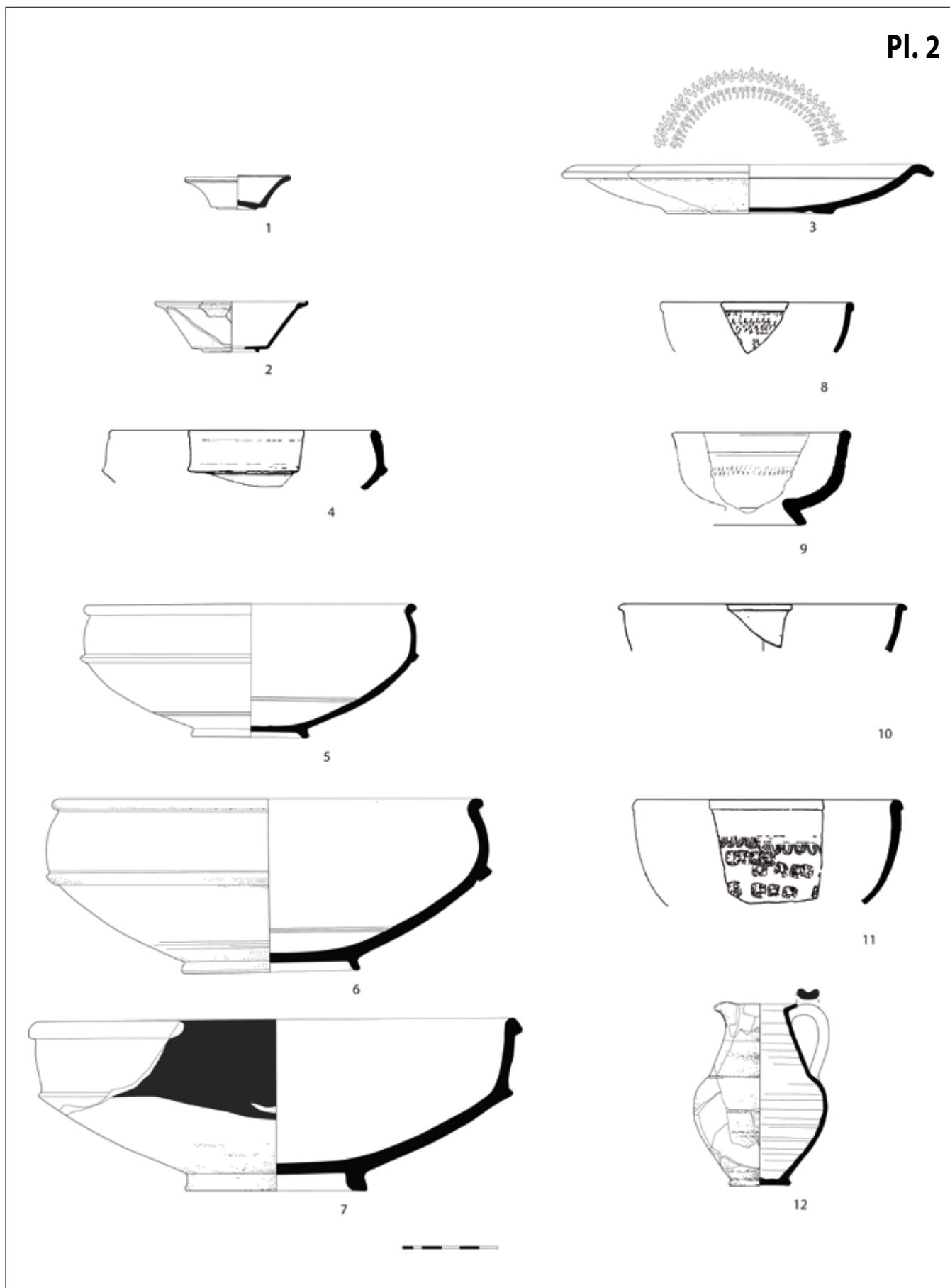

Plate 2 Colonial phase (made by T. Leleković)

GOODS FROM THE NORTH. AN UPDATE ON WARES, SHAPES AND OCCURRENCES OF PANNONIAN AND OTHER CONTINENTAL FINE WARES IN THE PROVINCE OF *DALMATIA*

Building upon recently published data on Pannonian slipped ware in Roman Dalmatia and the growing evidence of this and other continental wares in its coastal region, an overview of the current state of occurrences is provided. On these, though still scanty data, an interpretation of the changes within the pottery market of late 1st - early 3rd c. Dalmatia is attempted, taking into consideration possible supply networks and communication corridors. A view on the wider Adriatic region would seem to confirm that some of the detected phenomena are not restricted to its eastern coast, but seem to have influenced fine ware assemblages of both its shores.

Keywords: Pannonian slipped ware, Gaulish sigillata, Gaulish thin-walled ware, Marbled ware, province of Dalmatia

On the bases of current knowledge Roman fine ware production in Roman *Dalmatia* was limited in both time and produced classes. Ascertained production of thin-walled ware at the workshop in Crikvenica, NE Adriatic (Ožanić Roguljić 2011; 2019) is possibly accompanied by a production of mainly *barbottine* decorated beakers, in a range of pale fabrics whose production can, on the basis of distribution, be tentatively placed somewhere on the coast of *Dalmatia*, possibly southern *Liburnia* (Brusić 1999: 31; Konestra 2016: 201–203, 379–381; Konestra, Lipovac Vrkljan 2018; Ožanić Roguljić 2019). Both could be dated from the mid- 1st to the first half of the 2nd c. CE, although data is far from certain. Therefore, the province relied heavily on imports to fulfil the need for fine tableware vessels, as it did for other classes and products (cf. Konestra et al. 2020). Although each sub-region of what will be Roman *Dalmatia* presents its own specificities, in general it can be stated that in its coastal part, from the mid- 1st c. BCE, the main fine ware supply region was Italy, mainly the mid- and Upper Adriatic, and the Po valley, although connections with other regions existed before, but their scale, character and overall functioning is still to be delineated with more certainty (e.g. Borzić 2017; Čelhar, Borzić 2016: 72–83, Sl. 2; Govorčin, Borzić 2018: 55-57; Kirigin et al. 2005; Mihovilić 2002; Miše 2015; Šešelj, Ilkić 2015; Škoro 2020; Ugarković 2019). The monopoly of Italic producers lasted at least until the Flavians, giving way from the late 1st and during the 2nd c. CE to a more varied assortment of fine wares (Borzić, Eterović Borzić 2015: 34), including Eastern Mediterranean (mainly Eastern Sigillata B and TWW), north African (ARS) and, occasionally, products stemming from non-Mediterranean areas, accompanied with a larger distribution of tableware glass (Gregl, Lazar 2008). The mechanism of this shift, apart from following the more general demise of Italic *sigillata* workshops, is still elusive, but as new wares and occurrence data is available, it is worth presenting it as it may shed light not only on local consumption practices, but also on commercial and trade networks, thus being useful in understanding both the workings within receptive areas, just as hinting to those producing the objects under scrutiny.

THE EVIDENCE¹

Documented for the first time in *Dalmatia* in 2006 at the port of Zaton (ancient *Aenona's* port, Brusić 2006: 42; Gregl 2009), Pannonian slipped ware (usually termed PGW or PSW) (for the ware see e.g. Nagy 2017: 6, with bibliography therein) is so far the most widespread northern import in the coastal area of Roman *Dalmatia*. A recent overview of occurrences, on which we will build on, evidenced 15 sites on both islands and the coast where the ware is present with a limited array of shapes and in very limited amounts (Ožanić Roguljić, Konestra 2017) (Fig. 1, Tab. 1). A clustering emerged in the region of the Kvarner gulf, possibly to be connected with the communication passing through the port of *Senia* and inland over the Vratnik pass in its hinterland, allowing a direct reach of the road network towards *Siscia* (Glavaš 2010: 15; Ožanić Roguljić, Konestra 2017: 456; Migotti 2019: 234). A new overview enriched the distribution of the ware with seven certain sites: *Senia*, *Iader*, *Nedinum*, *Tragurium*, *Siculi*, Soline on Pakleni islands, Korčula island and with an occurrence possibly at *Salona* (Fig. 1, 2; see Tab. 1 for bibliography). These allowed to detect both new occurrences and new areas where the ware seems to be more present.

As far as shapes are concerned, new evidence does not bring any novelty, as the Drag. 37 derivative (e.g. Adler-Wölfel 2004: Sa 1.2, T. 3/36, Sü 2.2, T. 4/83), simple hemispherical bowls with rouletted/stamped decorations and inverted rim (e.g. Gregl 2009), and possibly new occurrences of plates (*Salona*, Korčula) are in line with the previously delineated typology (Ožanić Roguljić, Konestra 2017: 455–456, Fig. 2), with hemispherical bowls (Type 2a of said typology) remaining the most common shape (Fig. 2). These bowls resemble the Consp. 36.4 shape of *Tardo Padana* production, which is known to have in some cases used both rouletted and stamped decorations (e.g. Cipriano, Mazzocchin 2010: 147, Fig. 11).

All new occurrences are in gray slipped gray ware thus red slipped red ware Pannonian examples are still present only at Baška. Provenience from south Pannonian workshops seems to remain the most plausible one (Gregl 2009: 198; Ožanić Roguljić, Konestra 2017: 456), with the chronological framework still being within the 2nd c. CE.

Along with PGW, a number of other continental wares have been tentatively evidenced, usually with few occurrences within sites' assemblages. Among these, recent research started to evidence a more widespread presence of (south and central) Gaulish *sigillata*, so far present at *Tarsatica*, *Fulfinum*, *Senia*, *Ortopla*, *Aenona*, *Iader*, *Asseria*, *Burnum*, *Colentum*, *Tilurium*, and the shipwreck at Silba - Grebeni (Fig. 1; see Tab. 1 for bibliography). The shapes occurring include relief decorated bowls (predominantly Drag. 29 and 37, but also 25 and 35), plates, Bet 91 plate/bowl and a Bet 102 beaker (see Tab. 1 for bibliography). Proveniences include mostly La Graufenseque and much less Lezoux workshops, while chronology encompasses the later 1st c. and the first half of the 2nd (Borzić, Eterović Borzić 2015: 31; Konestra 2015: 162). Thin-walled ware from Gaul, on the other hand, while being earlier (early Claudian) is present at only two, both military sites - *Tilurium* and *Burnum* (Šimić-Kanaet 2003: 148; Šimić-Kanaet 2010: 32–33; Borzić 2020: 80–84: 69–72, 74–75).

With few or single site occurrences TWW of possible Siscian production² and possibly Marbled ware (e.g. Nagy 2018 with bibliography therein) have been identified at *Salona*, and the later at *Burnum*,³ Raetian ware (or possible imitation, such as Poetovian, cf. Istenič 1999: 134) at *Senia*, and 3rd-4th c. Pannonian glazed ware at *Iader* (Fig. 1, see Tab. 1 for bibliography), most indicatively occurring in the region's major harbours.⁴ Thus, in short, two groups of wares can be determined on the bases of origin, a south Gaulish and a Pannonian one, though the provenience of Marbled ware and the Raetian ware/imitation remain tentative.⁵

1 The authors would like to thank all institutions and colleagues who allowed review and publication of the material. In particular, Igor Borzić (Department of archaeology, University of Zadar) for signalling numerous new occurrences and unselfish permission to use unpublished data, Lujana Paraman (Trogir town museum) for the Trogir finds and Damir Kliškić (Archaeological Museum in Split) for invitation to study and publish the *Salona* - EVN material. Our gratitude goes to Mirko Rasić (Faculty of Humanities and Social Sciences, University of Mostar) for information on the *Bigeste* material, being studied within his PhD. Also, we would like to thank Ivana Miletić Čakširan (Ministry of culture, Conservation department in Sisak) for help with Siscian TWW and Alexandra Nagy (BHM Aquincum Museum) for help with bibliography. We are also thankful to the conference participants for their comments and insights.

2 Fabric would seem to support this attribution, though rim shape and wall thickness are uncommon for this production.

3 Marbled ware is known from several sites in Bosnia and Hercegovina (see Busuladžić 2012: 46, T. VIII/3–4 with earlier bibliography), and some new occurrences have been identified at Gračine (*Bigeste*).

4 An occurrence of possibly Gaulish TWW is reported for *Salona* by V. von Gonzenbach, but as it was not checked, and the description given ("*Hofheim 22 type with large barbotine scales, brownish slip*", von Gonzenbach 1975: 94) could indicate other production as well (local? Pannonian?), it will not be included in the discussion. Similarly, Gaulish *sigillata* from *Salona* is reported by De Mitri 2017, but seemingly not in the therein cited bibliography.

5 It must also be stressed that while all classes can be broadly dated between the end of the 1st and the 3rd c., only Gaulish and Pannonian TWW could be somewhat earlier, and glazed ware somewhat later. Aspects of the Raetian ware vessel from *Senia* have been discussed in Konestra 2015a, while the Marbled ware sherd from *Salona* could belong to Pannonian productions based on fabric and decoration (cf. Nagy 2018: 611-612 and fig. 2/6), but also to some other production area, as shape cannot be securely reconstructed.

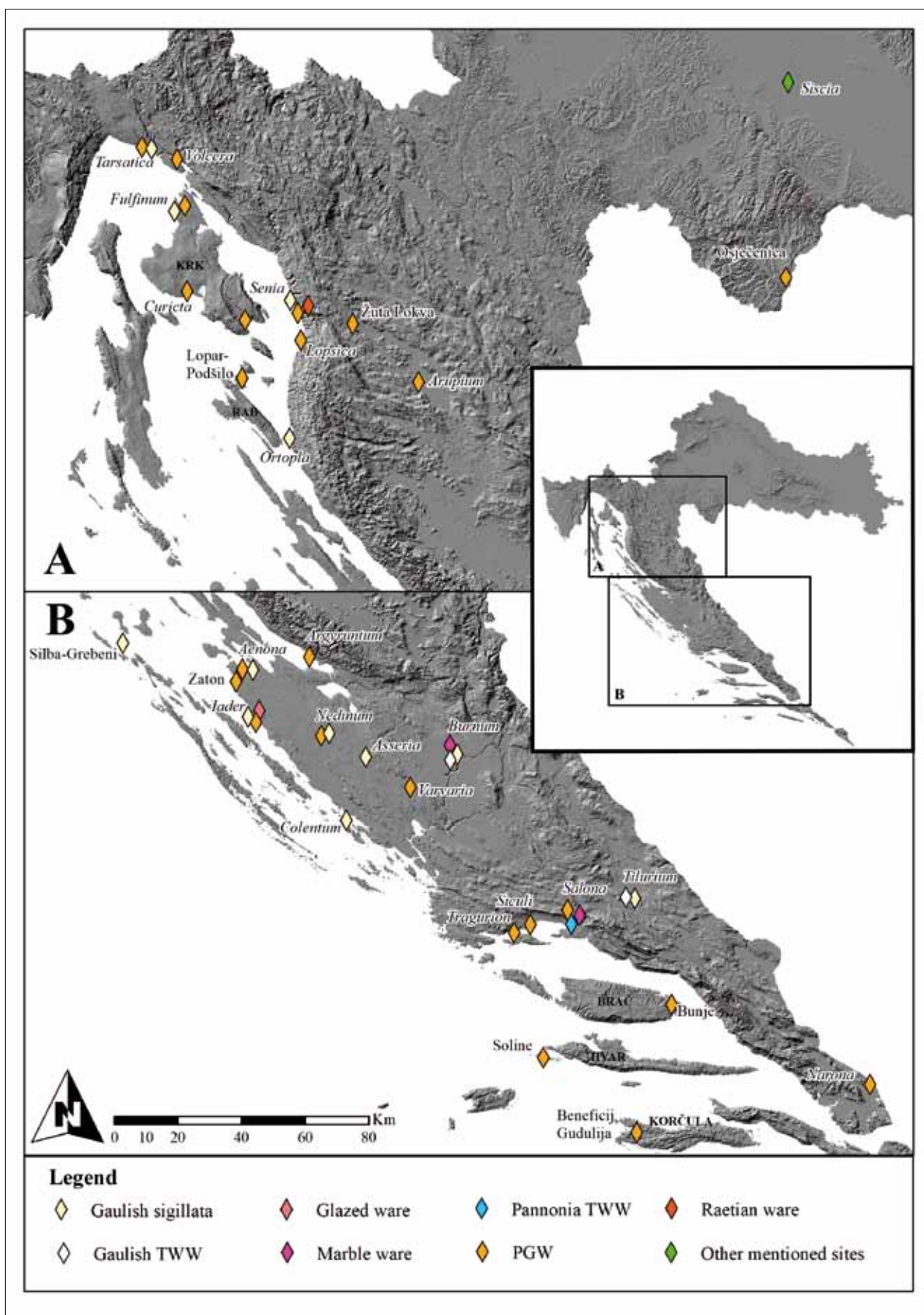

Fig. 1 Distribution of the tackled wares and location of Sisak/Siscia (basemap: EU-DEM; illustration: V. Glavaš).

N.	Site	Site type	Ware	Shape or type	Quantities	Bibliography or keeping institution
1	Tarsatica	Necropolis?	PGW	Plate	1	Ožanić Roguljić, Konestra 2017.
2		Urban centre (house?)	Gaulish sigillata	Decorated wall, Drag. 37?	1	Višnjić et al. 2020.
3	Volcera	Necropolis	PGW	Drag. 37 <i>similis</i> /Type 1a	1	Ljubić 1882; Ožanić Roguljić, Konestra 2017.
4	Fulfinum (Krk island)	Urban centre (forum, "villa")	PGW	Type 1b; Hemishperical bowl/Type 2	3	Konestra 2015; 2015a.
5		Urban centre (forum)	Gaulish sigillata	Bet 91	1	Konestra 2015.
6	Curicta (Krk island)	Necropolis	PGW	Hemishperical bowl/Type 2	2	Ožanić Roguljić, Konestra 2017; Samblich collection in Krk; Košljun monastery collection.
7	Baška (Krk island)	Necropolis	PGW	Hemishperical bowl/Type 2; base fragment	5	Bekić, Višnjić 2008.
8	Senia	Urban centre (Štela)	Gaulish sigillata	Bet 102	1	Konestra 2015.
9		Urban centre (Štela)	Raetian ware	Drexel I	1	Konestra 2015.
10		Urban centre (Štela)	PGW	Wall sherd	1	Senj town museum.
11	Lopsica	Unknown	PGW	Hemishperical bowl/Type 2	1	Ožanić Roguljić, Konestra 2017.
12	Lopar - Podšilo bay (Rab island)	Rural settlement	PGW	Hemishperical bowl/Type 2	1	Ožanić Roguljić, Konestra 2017.
13	Ortopla	Urban centre/harbour?	Gaulish sigillata	Decorated wall	1	Miholjek, Stojević 2012, t. 5/3.
14	Argyruntum	Urban centre (house?)	PGW	Drag. 37 <i>similis</i> /Type 1a	1	Glavaš, Borzić <i>in press</i> .
15	Grebeni off Silba island	Shipwreck	Gaulish sigillata	Drag 29?	1	Gluščević 2009.
16	Žuta Lokva	Rural settlement	PGW	Hemishperical bowl/Type 2	1	Ožanić Roguljić, Konestra 2017.
17	Arrupium	Urban centre	PGW	Hemishperical bowl/Type 2	1	Ožanić Roguljić, Konestra 2017.
18	Osječnica	Hillfort settlement	PGW	Varied	>15	Ožanić 1998.
19	Aenona	Urban centre	PGW	Hemishperical bowl/Type 2	1	Borzić 2013.
20		Urban centre, necropolis	Gaulish sigillata	Drag. 29, 37	10	Borzić 2013; Brusić 1999: 120–121.
21	Zaton	Harbour deposit	PGW	Drag. 37 <i>similis</i> /Type 1a; Hemishperical bowl/Type 2	10	Gregl 2009.
22	Iader	Urban centre	Gaulish sigillata	Drag. 29, 37	2	Brusić 1999: 122, cat. 430–431.
23		Urban centre	PGW	Hemishperical bowl/Type 2	1	Pešić 2017.
24		Urban centre	Glazed	Wall sherds	3	Pešić 2017.
25	Asseria	Urban centre	Gaulish sigillata	Drag. 25, 29, 35, 37	5	Brusić 1999: 121, cat. 421–423, 427; Borzić, Eterović Borzić 2015.
26	Nedinum	Urban centre	Gaulish sigillata	/	1	Personal communication by I. Borzić.
27		Urban centre	PGW	/	5	Personal communication by I. Borzić.
28		Necropolis	Gaulish sigillata	Drag. 35	1	Personal communication by I. Borzić.

N.	Site	Site type	Ware	Shape or type	Quantities	Bibliography or keeping institution
29	Varvaria	Urban centre	PGW	Hemishperical bowl/ Type 2	1	Ožanić Roguljić, Konestra 2017.
30	Burnum	Military camp	Gaulish TWW	Bowls and beakers	37 (n. of sherds)	Borzić 2020: 80–84.
31		Military camp	Gaulish sigillata	Drag. 29, 35;	10	Brusić 1999: 121, cat. 424, 425; Borzić 2020: 58–60.
32		Military camp	Marble ware	Base fragment (plate?)	1	Personal communication by I. Borzić.
33	Colentum (Murter island)	Urban centre?	Gaulish sigillata	Drag. 37	1	Brusić 1999: 120, cat. 420.
34	Tragurium	Urban centre (Berislavić house, Duke's palace)	PGW	Hemishperical bowl/ Type 2	2	Trogir town museum.
35	Siculi	Harbour deposit?	PGW	Hemishperical bowl/ Type 2	1	Radić Rossi 2005.
36	Salona	Urban centre (Porta Andetria)	Pannonia TWW	Base fragment (plate?)	1	Archaeological museum in Split; Konestra 2019.
37		Urban centre (Porta Andetria)	Marble ware	Base fragment (plate?)	1	Archaeological museum in Split; Konestra 2019.
38		Urban centre (Porta Andetria)	PGW	Base fragment (plate?)	1	Archaeological museum in Split; Konestra 2019.
39	Tilurium	Military camp	Gaulish TWW		9	Šimić-Kanaet 2003: 148, T. 11/5–6; Šimić-Kanaet 2010: –33; T. 73).
40		Military camp	Gaulish sigillata	Bases and decorated walls	4	Šimić-Kanaet 2010.
41	Bunje (Brač island)	Rural settlement	PGW	Plate	1	Ožanić Roguljić, Konestra 2017.
42	St. Clement - Soline (Pakleni islands)	Rural settlement	PGW	Drag. 37 <i>similis</i> //Type 1	1	Ugarković, Konestra 2018.
43	Beneficij Gudulija (Korčula island)	Rural settlement	PGW	Base fragment	1	Personal communication by I. Borzić.
44	Narona	Urban centre (Augusteum)	PGW	Hemishperical bowl/ Type 2	2	Topić 2002.

Table 1 Sites and wares evidence.

MARKETS, TRANSPORT AND CONSUMPTION

Lack of more precise contextual data for most of the occurrences, that is their association with other wares, and an overall small sample (little more than 100 sherds/vessels)⁶ limit interpretation possibilities, thus a more general approach and the delineation of some aspects will be tackled in the following paragraphs.

Although the dealt with pottery classes present each a particular production, distribution and marketing case, they are here treated together as indicative of non-Mediterranean, i.e. continental products, reaching the shores of the eastern Adriatic (limited to Roman *Dalmatia*), which is in turn regarded as a common consumption area. As such, it is possible to compare it to neighbouring areas in order to better comprehend certain aspects of their distribution.

The early and mid- Imperial eastern Adriatic pottery market, as mentioned, is characterised by imported fine wares, firstly Italian *sigillata* (ITS) and TWW, and later predominantly ES B (Maggi 2006; cf. also Gabler et al. 2009: 55–58) and ARS,⁷

6 Quantifications were done mostly by sherd count, while in case of few occurrences vessel numbers can be reconstructed. It is thus difficult to provide a definitive vessel count only on the bases of published data.

7 There is no regional overview of ARS distribution in Dalmatia, while the recent PhD thesis of Mladen Pešić tackled submarine finds of North African

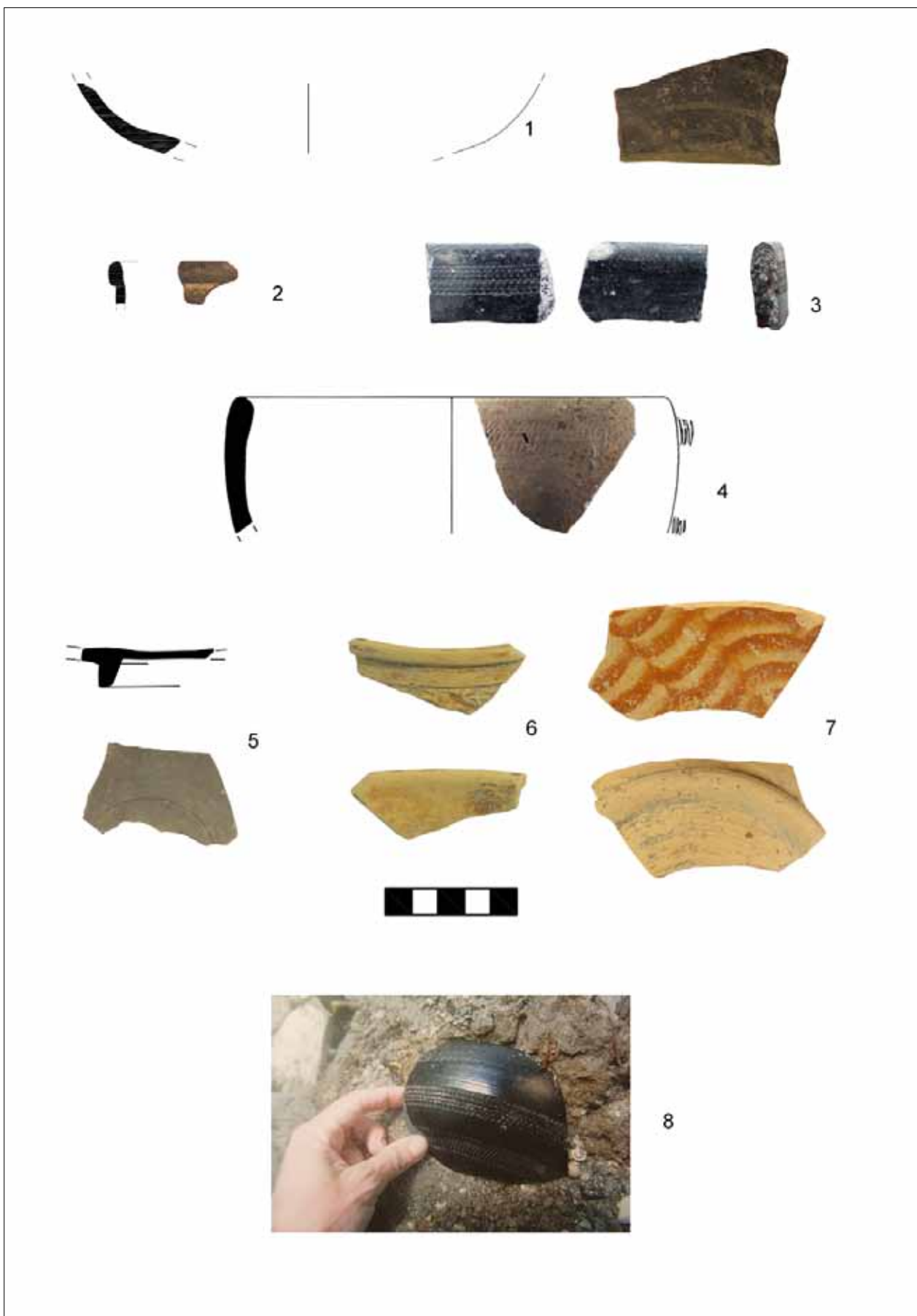

Fig. 2 New occurrences within the tackled wares: PGW - 1. Senia - Štela; 2. St. Clement - Soline; 3., 4. Tragurium; 5. Salona; 8. Siculi; Pannonian TWW? - 6. Salona; Marbled ware - 7. Salona (Drawings: A. Konestra, pictures: A. Konestra, L. Paraman; n. 7 from Radic Rossi 2006).

with minor occurrences of other wares among which Gaulish TWW, Pontic *sigillata* and Eastern Sigillata C/Çandarli ware could be signalled out (e.g. Borzić, Eterović Borzić 2015: 40–42 with an overview of the distribution; Paraman et al. 2020: 400, 409 for recent Trogir finds). In the context of ITS it is important to note that most of the occurrences belong to plain and relief Po valley wares, while only the eastward marketing of some Arretine potters (chiefly *Gellius*) will slightly disrupt this image from the second quarter of the 1st c. CE (already noted in Makjanić 1988, see also Konestra 2016). Also, import seems to end before a more widespread distribution of *Tardo Padana*, thus the evidence of this ware is scanty (cf. Borzić, Eterović Borzić 2015: 29–30). Along with *sigillata*, Po valley TWW⁸ was marketed for the whole duration of its production. Gaulish TWW, an “anomalous” occurrence in the region, seems to be present only at military sites (Borzić 2020: 84: 72; cf. note 2 above). All of this makes the Dalmatian coastal market radically different than the Pannonian one, which is firstly noticeable in different ratios of ITS *Arretina* and *Padana* and, among others, the distribution of *Tardo Padana*, local TWW and later Gaulish *sigillata*, in particular central and eastern Gaulish, and products from *Germania* (see Makjanić 1987: 231; 1988; Košćević, Makjanić 1995; Gabler et al. 2009a; Miletić Čakširan 2013/2014: 130; Hárshegyi, Ottományi 2013; Leleković 2018). Thus, for *Dalmatia* more similarities appear with the Upper and to a certain degree mid- Adriatic regions (cf. for certain areas and wares Makjanić 1988; Maggi 2006; Biondani 2014: 225; De Mitri 2017; Gabucci 2017: chap. 9), which in the 1st century CE acted as the main exporting areas for the eastern coast (Makjanić 1987: 233–234; Konestra 2016).

In this context the presence of the wares tackled here, especially Pannonian as the most numerous, cannot be regarded as circulating within a unique market, but as movements (import/export) between different production and consumption regions, i.e. they might signal the integration of different markets (see Brughmans, Poblome 2016).⁹ In fact, the supply networks of the two regions seem to have been different (see e.g. Mikl Curk 1992; Leleković 2018 for *Pannonia*; Makjanić 1987 for the NE Adriatic and *Siscia*), and few are the evidence indicative of possible commercial links (Migotti 1999–2000; 2019: 243–244; Reed, Ožanić Roguljić 2020: 53–54, 56; cf. also Migotti 2016: 158–159), among which PGW definitely stands out. What remains to be defined are the possible mechanism behind these sudden southward merchandise movements.

A recent overview of Adriatic occurrences of Gaulish *sigillata* enriched data on its presence along its western coast, with more examples in its northern and central part, and also in Albania, but overall with a very restricted repertoire (Drag. 39 and 37) and, it would seem, mostly few per site occurrences (De Mitri 2017: 352, 355–357, Fig. 5). A more detailed review of the presence of Gaulish *sigillata* in NE Italy (*Concordia*, *Aquileia*, *Tergeste* and the Friuli plains up to *Forum Iulii*) reveals a major presence of south Gaulish products (80% on a total of 331 vessels) and a larger typological variability, especially at *Aquileia*, the latter being also the only site where other productions are attested with some weight at all (Donat 2015: 39; Gabucci 2017: chap. 9, see also for other areas of the *Cisalpinia*). Dating of the maximum occurrence seems to fit within the Flavian - Trajanic period, as confirmed, along with other aforementioned data, by new evidence from Canale Anfora (Donat 2017: 101, and n. 2). In all cases occurrences can be linked to sites along the coast or sites located along the regional river network, i.e. in both cases waterway harbours, while the arrival of the ware in the region could have occurred via the roads or waterways network of the Po valley (Donat 2015: 42; Gabucci 2015: 71).

The distribution of other classes of continental wares has recently been tackled for the later area as well, including Pannonian TWW, PGW, and Raetian/imitation ware (Dobrevá, Mantovani 2017). All are present at *Aquileia* (see also Donat 2017: 153–154 for the Canale Anfora assemblage), but only Pannonian productions are further distributed within the Po valley, which occurred, according to the authors, along the coastal sea routes and the internal waterways of the Po basin (Dobrevá, Mantovani 2017: 236–237). As to reaching *Aquileia* in the first place, the road network stretching towards *Noricum* and *Pannonia* seems the most likely solution (Dobrevá, Mantovani 2017).

As for the eastern Adriatic, distribution of PGW, as already noted (*supra* and Ožanić Roguljić, Konestra 2017: 456), probably depended on the road system between *Pannonia* and the sea, with end-points at *Senia* (via *Siscia*),¹⁰ *Salona* (via *Servitium*, or other roads that connected the provincial capital to *Pannonia*) (Migotti 1999–2000; 2016, Fig. 4) and *Narona* (Marin 2018: 221–222). Judging on the numerous finds on the islands, but also within harbour assemblages (Zaton, and the “new” evidence from *Siculi*), the ware was further distributed by sea. *Salona*, but especially *Senia*, emerge as possible

products, thus offering an accurate distribution picture of at least harbour and shipwreck finds (Pešić 2019). Data was also presented at a conference in München in 2017, though still awaiting publication.

8 Including possibly Ravenna, *Aquileia* and other smaller production areas.

9 For the debate on Roman market integration (or the lack of it) see also Archibald 2013: 134 and the bibliography therein.

10 The presence of traders in the inland region of modern-day Lika (*Japodia*) is testified by the well known sarcophagus of *T(itus) Fl(avius) Marcellus, a seplasiarius* buried at Prozor (*Arupium*) in the 2nd c. CE (Cambi 2003; Glavaš 2010: 15); for *seplasiarius* as merchant of aromatic substances see Allé 2010: 209.

distribution hubs for the ware as, in the later case, occurrences are clearly grouped in its catchment area, of which the necropolis of Baška, as the site with the biggest number of occurrences in the region, is an example. Similarly, occurrences at sites within the Bay of Kaštela and the central Dalmatian archipelago, do point in the direction of *Salona* as their regional distribution starting point. A third possible cluster of occurrences is provided by the *lader - Aenona* area, with the port of Zaton emerging as a possible redistribution hub, being by far the coastal site with most occurrences. As for the second most numerous ware, Gaulish *sigillata*, a seaborne distribution, perhaps again from the centres of the Upper and mid-Adriatic, would seem probable (Brusić 1999: 32; Borzić, Eterović Borzić 2015: 34). Nevertheless, as has been stressed several times, with all probability Gaulish *sigillata* reached *Pannonia* via the *ripa Danubii*, and not through the Po valley and *Aquileia*, so to avoid double taxation (*quadragesima Galliarum + publicum portorium Illyrici*) (Gabler 2012: 51–54; Gabucci 2017, chap. 9), therefore, it is not inconceivable that these products reached *Dalmatia* through *Pannonia*, that is via the same routes as PGW. The occurrences of the other wares are still too few to allow a more detailed discussion, but it seems probable that all products of supposed Pannonian origin travelled along the same trajectories as PGW. As much as the here delineated scenario(s) seems plausible, especially if we keep in mind other, though still scanty evidence (Migotti 1999–2000), the possibility that the Upper Adriatic ports supplied *Dalmatia* with Pannonian products must, until further data will be available, also be considered plausible (just as it is possible that distribution worked the other way around). The earlier Lyon and south Gaulish TWW should probably be connected with military supply networks, their distribution being so far restricted to legionary camps (Borzić 2020: 84).

Routes and roads through which pottery distribution ran, just as the peculiarities behind the choice of one instead of another, are not dependent on simple logical, geographical or economical factors (Brughmans, Poblome 2015: 272), so we should rather speak of directions, as the amount of finds prevents the set up of a more complex analytical procedure. Nevertheless, if we accept that established urban markets functioned as high demand and highly receptive hubs for internal consumption and redistribution, than the proposed model might be a starting point in our understanding of the commercial activities involving the Adriatic and its hinterland.

PGW was a ware produced from the end of the 1st and into the 3rd c. CE (Adler-Wölfl 2004: 92–94), while its occurrence on the Adriatic seems to be constrained within the 2nd c. (Ožanić Roguljić, Konestra 2017: 458), indicating that in this period Pannonian production managed to reach a supra-regional distribution which included areas to the south and west, some of which had established contacts with *Pannonia*, i.e. *Aquileia* (cf. Zaccaria 1985; Gregoratti 2015; 2021; Migotti 2019: 243–244), others where these are not so evident, such as the eastern Adriatic. The reasons for such an occurrence could be sought within the functioning of Roman fine ware markets in other regions, and would imply, for starters, the emergence of large-scale production within the PGW industry, to which the emergence of large urban centres can be added, as they function as generators of high demand (Brughmans, Poblome 2016: 403). It is, in fact, from the Flavians to Hadrian that *Pannonia* lived an era of intense urbanisation along which the production and possibly highest output of PGW developed (Leleković 2018; Marin 2018: 232–246). Another aspect that should have been present are merchants/institutions active on multiple markets and thus having knowledge of the demand of each (Archibald 2013: 133, 136; Brughmans, Poblome 2016: 403), which in the case of the Upper Adriatic is easily envisaged knowing the role of *Aquileia* in supplying Pannonian markets (e.g. Gabler 1983; Gabucci 2015: 71; Gregoratti 2021; Stella 2018; Marin 2018: 206, 229–230), while in the case of the eastern coast it is again somewhat less evident (Migotti 1999–2000: 200). Indeed, PGW is so far a rare object of trade that links the two regions in a north-south trajectory, but if the factors here considered are correct, than merchants operating the PGW trade must have had connections within eastern Adriatic receptive areas. Gaulish *sigillata* on the other hand, if indeed marketed through the western Adriatic, might have followed the distribution trajectories of the local fine wares, possibly indicating their stability for a period after ITS's major output, as chronology would indicate. If, on the other hand, due to more favourable customs regimes, it travelled along the same routes as PGW, it could signal that with the onset of the 2nd c. old trade connection (and trajectories) started to fade, while new ones developed not only with the wider Mediterranean, but also, though apparently short-lived, with the hinterland.

CONCLUDING REMARKS

The few sherds that sprung the above delineated discussion, although growing in numbers as more studies and publications appear, still fall within the category of sporadic occurrences, or more bluntly within those few sherds that stand out of a generally homogenous, regionally typical site assemblage, often presenting problems of recognition and correct identification. Interestingly, they fall within a chronological timeframe, i.e. the end of the 1st and the 2nd c. CE

(with few possibly earlier or later finds), when the market of the eastern Adriatic was going through a phase of profound change, with certain wares losing ground (ITS, Italic TWW) and others gaining it (ES B, ARS).¹¹ It is perhaps a combination of factors internal to the various wares (larger output, better networking) and others relative to the receptive region, that is the need for an alternative fine ware supply, that opened a small window of opportunity allowing for continental wares to appear on the Adriatic, i.e. having a non-traditional supplier fulfilling a newly generated demand (e.g. Archibald 2013: 139). In a consumption sense, it is so far impossible to delineate a preferential usage of these wares, as it would seem that they entered the bulk of fine ware available on the market, being used in both urban and rural, settlement and funerary settings. Their redistributive potential is perhaps evidenced by harbour assemblages and capillary distribution, while Gaulish *sigillata* in one instance could be interpreted as ship's on-board equipment (Silba - Grebeni, Gluščević 2009). As noted for several other wares and amphorae, military sites tend to present somewhat different assemblages, with more varied proveniences, thus also in the case of the materials dealt with here, a dedicated supply network fulfilling the needs of the legionary camps would seem to have been in place for the Dalmatian camps as well (Borzić 2020: 186–187).

A topic that tentatively emerges from this analysis is that of how did the two pottery markets get to integrate? Were there contacts of other sorts through the circulation of different goods, as B. Migotti suggested (Migotti 1999–2000; 2019), thus facilitating the distribution of pottery by allowing the exchange of information on supply and demand? The presence of a *publicum portorium Illyrici* station at *Senia* (testified by inscriptions found at Vratnik in its hinterland) confirms that a certain amount of goods circulated by road, while a connection of *Senia* and *Siscia* has already been stressed (Glavaš 2010: 14–15). Similar inbound connections should be investigated in the case of other coastal commercial hubs as well. In fact, though *Aquileia* certainly played a major role in commerce with the north and northeast, one branch of inbound trade could have originated on the eastern Adriatic as well, following routes that are so far testified only as means for earlier military penetration (Migotti 1999–2000; Glavaš 2010).

In order to try to resolve these questions much more data should be known on the actual suppliers, let alone more evidence from the consumption side. Data from the internal region of province *Dalmatia*, here evidenced only by the border settlement of Osječenica, could prove fundamental in shedding more light on connections with *Pannonia*. Also, an approach that would combine other data, both historic and relative to other goods and classes of materials¹² could validate the proposed hypotheses and perhaps provide some answers to the delineated questions (Migotti 1999–2000; 2019: 244; Reed, Ožanić Roguljić 2020: 53–54, 56; cf. Rubio-Campillo et al. 2018), just as would a more detailed evaluation of ceramic assemblages that would consider not just the commonest wares, but also those that are uncommon, improbable or simply of problematic identification, as such occur on most systematically excavated sites (e.g. Gabucci 2015: 68). These could, in fact, evidence the relationships between each ware present and shed light on consumption practices (e.g. Archibald 2013: 142–143), as often these outliers allow to build a much more complex picture of connectivity and a more detailed account of marketing, and consumption practices.

ANA KONESTRA
Institute of Archaeology, Zagreb
Jurjevska ulica 15
HR - 10000 Zagreb
ana.konestra@gmail.com

VEDRANA GLAVAŠ
Department of Archaeology
University of Zadar
Obala Kralja Petra Krešimira IV, 2
HR - 23000 Zadar
vedrana.glavas@gmail.com

MARINA UGARKOVIĆ
Institute of Archaeology, Zagreb
Jurjevska ulica 15
HR - 10000 Zagreb
marina.ugarkovic@iarh.hr

11 In parallel, a shift in coarse wares can be envisaged as well (Aegean CW, African CW), but further studies on Italic cooking wares are necessary to better define the chronological frame of their import.

12 For example, the distribution of Istrian Dr. 6B olive oil amphorae seems to favour western and northern regions (Bezecky 2019: Fig.1.5), but is so far sporadic in *Dalmatia*.

BIBLIOGRAPHY

- Adler-Wölfl, K. 2004, *Pannonische Glanztonware aus dem Auxiliarkastell von Carnuntum*, Wien.
- Allé, F. 2010, Travail et identité professionnelle. Analyse lexicographique des métiers du parfum dans l'Occident romain, *L'antiquité classique*, Vol. 79, 199–212 (DOI: <https://doi.org/10.3406/antiq.2010.3774>)
- Archibald, Z. 2013, Joining up the dots: making economic sense of pottery distributions in the Aegean and beyond, in: Tsingarida A., Viviers D. (eds.), *Pottery Markets in the Ancient Greek World (8th - 1st centuries B.C.)*, Proceedings of the International Symposium held at the Université libre de Bruxelles 19-21 June 2008 (Études d'archéologie 5), Bruxelles, 133–157.
- Bekić, L., Višnjić, J. 2008, Južni dio antičke nekropolena položaju Sv. Marko - Baška / Southern part of the Roman necropolis on the Sv. Marko - Baška site, *Vjesnik Arheološkog muzeja u Zagrebu*, Vol. XLI, n. s. 3, 209–258.
- Bezecky, T. 2019, Istria and the amphorae workshops, in: Bezecky T. (ed.) *Amphorae Research in Castrum Villa on Brijuni Island*, Wien, 3–10.
- Biondani 2014, Sigillata orientale B (Eastern sigillata B), in Mazzeo Saracino L. (ed.), *Scavi di Suasa I. I reperti ceramici e vitrei dalla domus dei Coiedii*, Bologna, 225–226.
- Borzić, I. 2013, Antika, in: *Arheološka istraživanja okoliša crkve sv. Križa u Ninu* (exhibition catalogue), Nin, 27–58.
- Borzić, I. 2017, Ceramic Finds, in: *The City of the Dead on the Field of Life: The Necropolis of the Kopila Hillfort on the Island of Korčula*, Fadić, I., Eterović Borzić, A. (eds.), Zadar: Muzej antičkog stakla, 61–85.
- Borzić, I. 2020, *Keramički nalazi iz legijskog logora Burnum*, Šibenik – Puljane.
- Borzić, I., Eterović Borzić, A. 2015, *Terra sigillata* from Roman Asseria - a contribution towards understanding pottery import in Liburnia, *Asseria*, Vol. 13, 11–88.
- Brughmans, T., Poblome, J. 2015, Pots in Space. An Exploratory and Geographical Network Analysis of Roman Pottery Distribution, in: Barker, E., Bouzarovski, S., Pelling, C., Isaksen, L. (eds.), *New Worlds from Old Texts: Revisiting Ancient Space and Place*, Oxford, 255–279.
- Brughmans, T., Poblome, J. 2016, Roman bazaar or market economy? Explaining tableware distributions through computational modelling, *Antiquity*, Vol. 90/350, 393–408.
- Brusić Z. 1999, *Hellenistic and Roman Relief Pottery in Liburnia*, Oxford.
- Brusić, Z. 2006, Il porto liburnico e romano di Aenona (Nin), in: Radić Rossi, I. (ed.), *Archeologia subacquea in Croazia: studi e ricerche*, Venezia, 33–46.
- Busuladžić, A. 2012, Rimska vila na lokalitetu Mlinčići – Podmočilo u selu Tišina kod Zenice/The Roman villa at Mlinčići – Podmočilo in the village of Tišina near Zenica, *Glasnik Zemaljskog muzeja Bosne i Hercegovine u Sarajevu*, Vol. NS 53, 137–244.
- Cambi, N. 2003, Bilješka o japodskim urnama i sarkofazima, *Senjski zbornik*, Vol. 30, 97–108.
- Cipriano, S., Mazzocchin, S. 2010, Un quartiere artigianale a Patavium. La fornace per la produzione di terra sigillata tardo-padana, *Rei Cretariae Romanae Favtorvm Acta*, Vol. 41, 141–153.
- Čelhar, M., Borzić, I. 2016, Gradina u Zemunik Donjem – nalazi željeznog i rimskog doba, in: J. Faričić, Z. Dundović (eds.), *Zemunik u prostoru i vremenu*, Zadar, 69–117.
- De Mitri, C. 2017, Ceramiche fini da mensa di produzione occidentale nell'area ionico-adriatica (II sec. a.C. – II sec. d.C.): presenza e circolazione nella penisola salentina, in: Lipovac Vrkljan G., Šiljeg B., Ožanić Roguljić I., Konestra A. (eds.) *Roman pottery and glass manufactures. Production and trade in the adriatic region. Proceedings of the 3rd archaeological colloquy*, Crikvenica 4-5.11.2014, Crikvenica - Zagreb, 351–360.
- Dobrova, D., Mantovani, V. 2017, Ceramiche fini di produzione dalmata, pannonica, retica e di Treviri ad Aquileia, in: Lipovac Vrkljan G., Šiljeg B., Ožanić Roguljić I., Konestra A. (eds.), *Roman pottery and glass manufactures. Production and trade in the adriatic region. Proceedings of the 3rd archaeological colloquy*, Crikvenica 4–5. 11. 2014, Crikvenica - Zagreb, 225–253.
- Donat, P. 2015, *Terra sigillata* gallica in Italia nordorientale. Dalle collezioni museali alle scoperte recenti, *Quaderni Friulani di archeologia*, Vol. XXVI/1, 39–51.
- Donat, P. 2017, Ceramica fine medioimperiale di incerta produzione, in: Maggi P., Maselli Scotti F., Pesavento Mattioli S., Zulini E. (eds.), *Materiali per Aquileia. Lo scavo di Canale Anfora* (Scavi di Aquileia IV), Trieste, 153–155.
- Gabler, D. 1983, Rapporti commerciali fra Italia e Pannonia in età romana, *Archeologia Classica*, Vol. 35, 88–117.
- Gabler, D. 2012, Sigillate galliche meridionali ad Emona e in Italia, in: Lazar, I., Županek, B. (eds.), *EMONA. Between Aquileia and Pannonia*, Koper, 49–59.
- Gabler, D., Hárshegyi, P., Lassányi, G., Vámos, P. 2009, Eastern Mediterranean import and its influence on local pottery in Aquincum, *Acta Archaeologica Academiae Scientiarum Hungaricae*, Vol. 60, 51–72.
- Gabler, D., Márton, A., Gauthier, E. 2009a, La circulation des sigillées en Pannonie d'après les estampilles sur sigillées lisses de Gaule, de Germanie et de la Région danubienne, *Revue archéologique de l'Est* [Online], Vol. 58, URL : <http://journals.openedition.org/rae/5575> (visited on: 9 May 2020).
- Gabucci, A. 2015, Sigillate galliche nella Cisalpina orientale, in: B. Callegger (ed.), *Studia archaeologica Monika Verzar Bass Dicata*, Trieste, 67–78.
- Gabucci 2017, chap. 9, Altri centri dell'Italia settentrionale, in: *Attraverso le Alpi e lungo il Po: importazione e distribuzione di sigillate galliche nella Cisalpina*, con un contributo di Paola Bordigone [en ligne]. Roma: Publications de l'École française de Rome, 2017 (généré le 19 novembre 2020). Disponible sur Internet : <http://books.openedition.org/efr/3350>. DOI : <https://doi.org/10.4000/books.efr.3350>.
- Glavaš, V. 2010, Prometno i strateško značenje prijevoja

- Vratnik u antici, *Senjski zbornik*, Vol. 37, 5–18.
- Glavaš, V., Borzić, I., in press, Rezultati arheološkog istraživanja ispred župne crkve sv. Jurja u Starigradu, in *Zbornik Starigrad Paklenica*, forthcoming.
- Gluščević, S. 2009, The Roman shipwreck from the 1st Century AD at Grebeni by the island of Silba (preliminary result), *Archaeologia Maritima Mediterranea*, Vol. 6, 69–87.
- Govorčin, P., Borzić, I. 2018, Prilog poznavanju helenističke keramike iz liburnske Aserije, *Asseria*, Vol. 14, 29–66.
- Gregl, Z. 2009, O importu panonske keramike ukrašavane pečatima u Dalmaciju, in: Bekić L. (ed.), *Jurišićev zbornik. Zbornik radova u znak sjećanja na Mariju Jurišića*, Zagreb, 198–205.
- Gregl, Z., Lazar, I. 2008, *Bakar. The glass from the Roman cemetery*, Zagreb.
- Gregoratti, L. 2015, Aquileian Families in Pannonia and Upper Moesia, in Tsetschladze, G.R., Avram, A., Hargrave, J. (eds.), *The Danubian Lands between the Black, Aegean and Adriatic Seas (7th Century BC-10th Century AD). Proceedings of the Fifth International Congress on Black Sea Antiquities*, Oxford, 219–222.
- Hárshegyi, P., Ottományi, K. 2013, Imported and local pottery in late Roman Pannonia, *Late Antique Archaeology*, Vol. 10, 471–528
- Istenič, J. 1999, *Poetovio - zahodna grobišča I. Grobne celote iz Deželnega muzeja Joanneneuma v Gradcu*, Ljubljana.
- Kirigin, B., Katunarić, T., Šešelj, L. 2005, Amfore i fina keramika (od 4. do 1. st. pr. Kr.) iz srednje Dalmacije: preliminarni ekonomski i socijalni pokazatelji, *Vjesnik za arheologiju i povijest dalmatinsku*, Vol. 98, 7–21.
- Konestra, A. 2015, Pottery from the Forum of Municipium Flaviu Fulfinum (Krk Island, Croatia) – research between 2007 and 2013, *Prilozi Instituta za arheologiju u Zagrebu*, Vol. 32, 147–214.
- Konestra, A. 2015a, Ricerche nei musei della Liburnia settentrionale (Quarnero, Croazia): potenzialità, nuove attestazioni e aggiornamenti sulla diffusione di alcune tipologie ceramiche, *Quaderni friulani di archeologia*, Vol. XXV, 117–122.
- Konestra, A. 2016, *Italska terra sigillata i keramika tankih stijenki na području sjeverne Liburnije: tipologija, kronologija, distribucija*, unpublished PhD thesis, University of Zadar, Zadar.
- Konestra, A. 2019, Antičko i kasnoantičko keramičko posuđe, in: Anić, H. (ed.), *Salona iza Porta Andetria. Arheološka istraživanja u ulici Stjepana Radića u Solinu*, Split, 41–62.
- Konestra, A., Lipovac Vrkljan, G. 2018, Pottery workshops in the coastal area of Roman Dalmatia: landscape, spatial organization, ownership, in: Janežič, M., Nadbath, B., Mulh, T., Žižek, I. (eds.), *Nova otkritja med Alpami in Črnim morjem Rezultati raziskav rimskodobnih najdišč v obdobju med leti 2005 in 2015. Zbornik 1. mednarodnega arheološkega simpozija* (Ptuj, 8. in 9. oktober 2015.), Ljubljana, 127–141.
- Konestra, A., Lipovac Vrkljan, G., Šiljeg, B. 2020, Bricks and tiles of Sextus Me(u)tillius Maximus: a pottery workshop at Crikvenica (Croatia) and its assortment of ceramic building materials, *Prilozi Instituta za arheologiju u Zagrebu*, Vol. 37, 73–98.
- Koščević, R., Makjanić, R. 1995, *Siscia, Pannonia Superior. Finds and Metalwork Production. Terra Sigillata*, Oxford.
- Leleković, T. 2018, How were Imitations of Samian Formed?, *Internet Archaeology*, Vol. 50 (<https://doi.org/10.11141/ia.50.18>).
- Ljubić, Š. 1882, Arheološko iskapanje u Bakru, *Vijesnik arheološkog muzeja u Zagrebu*, Vol. IV, 1–9, 48–54, 66–67.
- Makjanić, R. 1987, Plain Italian sigillata on the Northeast Adriatic coast and Sisak, *Rei Cretariae Romanae Favtorvm Acta*, Vol. 25–26, 225–239.
- Makjanić, R. 1988, Note on Later Arretine and “North Italian” Plain Sigillata Supply, *Bulletin of the Institute of Archaeology*, Vol. 25, 55–65.
- Maggi, P. 2006, La distribuzione delle sigillate di produzione orientale nell’arco Adriatico nord-orientale: problemi di metodo, in: Čače, S., Kurilić, A., Tassaux, F. (eds.), *Les routes de l’Adriatique antique : géographie et économie : actes de la Table ronde du 18 au 22 septembre 2001 (Zadar) / Putovi antičkog Jadrana, geografija i gospodarstvo. Radovi s Okruglog stola održanog u Zadru od 18. do 22. rujna 2001.*, Bordeaux – Zadar, 179–194.
- Marin, E. 2018, *Mursa. Hadrijanova kolonija uz limes rimskog carstva*, Mursa Aeterna IV, Zagreb – Osijek.
- Migotti, B. 1999–2000, Prilog poznavanju putova trgovine između Dalmacije i Panonije, *Opuscula archaeologica*, Vol. 23–24, 195–202.
- Migotti, B. 2016, Interaction Between Incomers and Autochthons on Roman Funerary Stones from the Croatian Region of Pannonia (1st–4th Centuries), in: D. Davison, V. Gaffney, P. Miracle, J. Sofaer (eds.), *Croatia at the Crossroads. A Consideration of Archaeological and Historical Connectivity*, Archaeopress, Oxford: 157–167.
- Migotti, B. 2019, Jadranski utjecaj na proizvodnju južnopanonskih stela: Dalmacija ili sjeverni Jadran?, *Prilozi povijesti umjetnosti u Dalmaciji*, Vol. 44, 231–246.
- Miholjek, I., Stojević, I. 2012, Stolno posuđe i glinene svjetiljke iz podmorja Ortope, *Opuscula archaeologica*, Vol. 36, 143–174.
- Mihovilić, K. 2002, Kristina Mihovilić, Grčki i helenistički nalazi u Istri i Kvarneru, in: Cambi, N., Čače, S., Kirigin, B. (eds.) *Grčki utjecajna istočnoj obali Jadrana*, Split, 499–520.
- Mikl Curk, I. 1992, La ceramica italyca e i trasporti verso nord-est, *Rei Cretariae Romanae Favtorvm Acta*, Vol. 31–33, 465–474.
- Miletić Čakširan, I. 2013/2014, Thin-walled pottery from the site “Sv. Kvirin” in Sisak, *Opuscula archaeologica*, Vol. 37/38, 111–160.
- Miše, M. 2015, *Gnathia and related Hellenistic ware on the East Adriatic coast*, Oxford.
- Nagy, A. 2017, *Resatus and the stamped pottery* (Aquincum Studies 1), Budapest.
- Nagy, A. 2018, Marbled Ware in Lágymányos (south of Aquincum), *Rei Cretariae Romanae Favtorvm Acta*, Vol. 45, 611–621.
- Ožanić Roguljić, I. 2011, Terra sigillata i keramika tankih stijenki s lokaliteta Crikvenica - Igralište, in: Lipovac

- Vrkljan G., Šiljeg B., Radić Rossi I. (eds.), *Roman pottery and glass manufactures. Production and trade in the adriatic region. Proceedings of the 1st archaeological colloquy*, Crikvenica 23-24.10.2008, Crikvenica - Zagreb, 31–38.
- Ožanić Roguljić, I. 2019, Thin walled pottery from Žuta Lokva, in: Dolenz, H., Strobel, K. (eds.), *Chronologie und vergleichende Chronologien zum Ausgang der Römischen Republik und zur Frühen Kaiserzeit* (Kärntner Museumsschriften 87), Klagenfurt, 427–435.
- Ožanić Roguljić, I., Konestra, A. 2017, Pannonian slipped ware in Dalmatia, in Lipovac Vrkljan G., Šiljeg B., Ožanić Roguljić I., Konestra A. (eds.), *Roman pottery and glass manufactures. Production and trade in the adriatic region. Proceedings of the 3rd archaeological colloquy*, Crikvenica 4-5.11.2014, Crikvenica - Zagreb, 453–460.
- Paraman, L., Ugarković, M., Scheifinger, J., Rembart, L., Oberndorfer, D., Visković, E., Schintlmeister, L., Klostermann, P., Binder, M., Steskal, M. 2020, Report on New Excavations in Ancient Trogir. The 2018 Croatian-Austrian Mission, *Jahreshefte des Österreichischen Archäologischen Institutes in Wien*, Vol. 88, 387–459.
- Pešić, M. 2017, Antiquity Period Fine Pottery and Oil Lamps from St Nicholas in Zadar, in Bekić L., Vrkić Š., Pešić M., Surić R. (eds), *Saint Nicholas in Zadar. Archaeological Excavations at Zadar's St Nicholas Monastery Complex 2014-2016*, Zadar, 63–73.
- Pešić, M. 2019, Afrički import iz hrvatskog podmorja od I. do V. stoljeća, unpublished PhD thesis, University of Zadar, Zadar.
- Radić Rossi, I. 2006, Kaštel Štafilić - Resnik, *Hrvatski arheološki godišnjak*, 2/2005, 355–356.
- Reed, K., Ožanić Roguljić, I. 2020, The Roman Food System in Southern Pannonia (Croatia) From the 1st–4th Century A.D., *Open Archaeology*, Vol. 6, 38–62.
- Rubio-Campillo, X., Montanier, J.M., Rull, G., Bermúdez Lorenzo, J.M., Moros Díaz, J., Pérez González, J., Remesal Rodríguez, J. 2018, The ecology of Roman trade. Reconstructing provincial connectivity with similarity measures, *Journal of Archaeological Science*, Vol. 92, 37–47.
- Stella, A. 2018, Viminacium coins from Aquileia and Venetia et Histria, in: Ivanišević, V., Borić-Brešković, B., Vojvoda, M. (eds.), *Proceedings of the International Numismatics Symposium Circulation of Antique Coins in Southeastern Europe - Viminacium, Serbia 15-17 September 2017*, Belgrade, 115–129.
- Šešelj, L., Ilkić, M. 2015, Maritime trade in the Pre-Roman Period in the Eastern Adriatic: a preliminary report on a ceramic and numismatic evidence in Liburnia, in: Marion, Y., Tassaux, F. (eds.), *Adri Atlas et l'histoire de l'espace adriatique du vie s. a.C. au viiie s. p.C. Actes du colloque international de Rome (4-6 novembre 2013)*, Bordeaux, 419–433.
- Škoro, I. 2020, Južnoitalska mat slikana keramika iz Zadra: arheološka istraživanja do 1989. godine, *Diadora*, Vol. 33-34, 69–100.
- Šimić Kanaet, Z. 2003, Keramika, in: M. Sanader, M. Doneus, Z. Šimić-Kanaet, T. Šeparović, D. Tončinić, Z. Buljević (eds.), *Tilurium I, Istraživanja 1997. – 2001.*, Zagreb, 109–188
- Šimić Kanaet, Z. 2010, *Tilurium II, Keramika 1997. – 2006.*, Zagreb.
- Topić, M. 2002, Stolno posuđe i glinene svijetiljke iz Augusteuma Narone, *Vijesnik za arheologiju i historiju dalmatinsku*, Vol. 95, 183–344.
- Ugarković, M. 2019, *Geometrija smrti: isejski pogrebni obredi, identiteti i kulturna interakcija. Antička nekropola na Vlaškoj njivi, na otoku Visu / The Geometry of Death: Issa's burial rites, identities and cultural interaction The ancient necropolis at Vlaška njiva on the island of Vis*, I/1-2, Katalozi i monografije Arheološkog muzeja u Splitu 6, Split–Zagreb.
- Ugarković, M., Konestra, A. 2018, Hellenistic and Roman fine-wares from Soline bay on St. Clement island near Hvar, in: M. Ugarković (ed.), *Praetoria longe lateque lucentia. Zbornik radova posvećen Vlasti Begović povodom 65. obljetnice života*, ZIA Vol. 8, Zagreb, 71–107.
- Višnjjić, J., Pamić, S., Bekić, L., 2020, Rezultati arheoloških istraživanja provedenih na trgu Ivana Koblera u Rijeci - tragovi antičke Tarsatike, *Histria Archaeologica*, 87–152.
- von Gonzenbach 1975. Pottery from closed deposits, in: Clairmont, C. W., Auth, S. I-I., von Gonzenbach, V. (Eds) *Excavations at Salona, Yugoslavia, 1969-72*, Park Ridge (NJ), 181–209.
- Zaccaria, C. 1985, Testimonianze epigrafiche dei rapporti tra Aquileia e l'Ilirico in età imperiale romana, *Antichità Altoadriatiche*, Vol. XXVI, 85–127.

SAŽETAK

ROBA SA SJEVERA.

NOVOSTI O KERAMIČKIM VRSTAMA, OBLICIMA I POJAVNOSTI PANONSKOGA I DRUGOGA KONTINENTALNOG FINOG STOLNOG POSUĐA U PROVINCIJI DALMACIJI

Ključne riječi: Panonska keramika s premazom, Galska sigilata, Galska keramika tankih stijenki, mramorizirana keramika, provincija Dalmacija

U radu se daje pregled trenutnoga stanja istraženosti pojavnosti panonske keramike s premazom i drugih vrsta kontinentalnoga finoga stolnog posuđa na obalnome području provincije Dalmacije, temeljeći se na nedavno objavljenom pregledu distribucije panonskih proizvoda i novim prikupljenim podacima. Interpretacijom tih, još uvijek tek preliminarnih podataka, predlažu se razlozi i modaliteti promjena uočenih na tržištu keramike od kraja 1. do ranog 3. st. na području Dalmacije, uzimajući u obzir moguće mreže opskrbe i komunikacijske koridore. Sagledavajući pak širi jadranski prostor moguće je primijetiti kako neki od detektiranih fenomena nisu ograničeni samo na njegov istočni dio, već su moguće utjecali na trendove u korištenju keramičkih proizvoda obiju jadranskih obala.

PANNONISCHE GLANZTONWARE IM NORDWESTEN PANNONIENS – CARNUNTUM UND VINDOBONA, MIT EINER AUSWERTUNG DER WARE IN DER PROVINZ UND IM ALLGEMEINEN

The author deals with several topics in the article: Chapter I, based on the papers published so far, provides a comparative analysis of the PGW of the Northwest Group with an emphasis on material from Carnuntum and Vindobona. A description of ceramics, a range of pottery shapes and printed ornaments are given. Special subchapters deal with findings from Carnuntum and Vindobona concerning these characteristics and possible imports from other parts of Pannonia. In II the chapter gives a general overview of the PGW within the province of Pannonia. In addition to basic data on this type of ceramics, three or four main groups are processed, which are also geographically conditioned - Northeast Group (with the main production centre in Aquincum Northwest Group (Savaria, Carnuntum, Vindobona), Southwest Group (Emona) and Southeast Group (Sirmium) also indicates the possible ways of influence from specific production centers to other centres, including the issue of local production within the Southwestern Group and the question of the origin of PGW in parts of southwestern Pannonia and Dalmatia (today's Croatia).

The III. and the last chapter deals with possible influences and prototypes which could have influenced the origin of PGW, these concerns some praeroman forms and decoration and also the manufacturing technique is similar (various Hellenistic ceramics with printed ornaments, Terra Sigillata, etc.). In addition, examples of the production of ceramics with a glossy coating outside Pannonia, as well as in late antiquity, are briefly cited.

Key words: Pannonian slipped ware, Vindobona, Carnuntum

I. NORDWESTPANNONIEN: EINE AUSWAHL PANNONISCHER GLANZTONWARE AUS VINDOBONA UND CARNUNTUM

Charakteristika, Formenspektrum, Stempelmotive

Pannonische Glanztonware (PGW) liegt aus *Vindobona* und *Carnuntum* in größerer Anzahl vor. Die Veröffentlichung der Funde hat eine lange Tradition und begann noch Ende des 19. Jhs. Sie intensivierte sich in den letzten 30 Jahren. Es seien hier nur die wichtigsten Publikationen genannt.

Für *Vindobona* sind es: PGW aus der *Canabae legionis* (Wien 1): Kronberger 2004 und Pavić 2004, PGW aus dem Legionslager: Adler-Wölfel 2010, PGW aus der Zivilsiedlung im Wiener 3. Bezirk: Berger-Pavić 2021a, Berger-Pavić 2021b.

Für *Carnuntum*: PGW aus dem Legionslager und Umgebung: Grünewald 1979, Grünewald 1983, Gassner 1991, Petznek 2000, PGW aus der Zivilstadt: Petznek, Radbauer 2004, Petznek 2006, Parrer 2007, Berger-Pavić, im Druck.

Das Material aus *Savaria*, *Salla* und weiteren westungarischen Fundorten, die zur NW-Gruppe der PGW gehören, hat É. Maróti in mehreren Arbeiten zusammengestellt und bearbeitet (u.a. 1987a, 1987b, 1990)¹.

Neue Funde werden laufend in den Zeitschriften „Fundort Wien“ und „Carnuntum Jahrbuch“ sowie in den Monographien und Reihen „Wiener Archäologische Studien (WAS)“, „Monografien der Stadtarchäologie Wien“, „Der Römische Limes in

¹ Für weitere Litteratur s. Adler-Wölfel 2004: 96–103.

Österreich (RLÖ)“ und anderen veröffentlicht. Ausgewählte Stücke fanden Aufnahme in den Ausstellungskatalogen des Museum Carnuntinum (Kat. Carnuntum 1992, Kat. Carnuntum 2006).

Die an Terra Sigillata oder Terra Nigra erinnernde Warengruppe wurde orange und grau gebrannt, bzw. in Modus A („oxidierend“) und Modus B („reduzierend“) hergestellt. Während sich in *Vindobona* die Gefäße beider Brennverfahren die Waage halten, ist in der Carnuntiner Zivilstadt eine Prävalenz von „reduzierend“ gebrannten Gefäßen feststellbar. Eine fundbasierte chronologische Differenzierung ist noch ausstehend, doch scheint die dunkle bzw. die schwarze PGW die ursprüngliche zu sein: die ältesten Stempeldekore finden sich in NW-Pannonien auf der Bodeninnenseite von reduzierend gebrannten Gefäßen.

Das Formenspektrum umfasst bis jetzt ca. 109 Formen mit Varianten, die auf den Tafeln 1–8 gegeben sind. Es setzt sich aus Hoch- und Breitgefäßen zusammen: Tellern, Schüsseln, Schalen, Bechern, Töpfen, Deckeln und Gefäßen mit gelochter Einlage („Siebe“). Die Fundorte, die bei den einzelnen Typen/Formbeispielen angeführt sind, dienen der Orientierung und bedeuten nicht, dass eine Form nur an diesem bestimmten Fundort belegt ist. Es ist allerdings festzustellen, dass nicht alle Formen an beiden Orten belegt sind, für das Fundspektrum einzelner Fundorte sind daher die jeweiligen Publikationen heranzuziehen.

Zusammenfassend ist zu den Formen festzuhalten: sie orientieren sich in erster Linie an gallischen Terra Sigillata (TS) Formen (Drag. 18/31, Drag. 33, Drag. 37 etc.) und Dekorstilen. Es kommen aber auch Formen vor, die auf vorrömische Keramiktraditionen hinweisen bzw. zurückgehen, wie der Teller mit ausschwingender Wandung und Standplatte (Te 7), der Teller mit gerundeter Wandung und Standplatte (Te 8; pompejanisch rote Platten), die Schalen und Schüsseln mit abgewinkeltem Rand (Sa/Sü 4.3) und die Töpfe mit eingeschnürter Wandung (Tö 3; s. dazu Kap. III.1)². Genaue oder direkte Vorbilder aufzuzeigen ist diffizil, denn die Gefäßformen wurden möglicherweise nicht unmittelbar vom Original „kopiert“, sondern bereits von einer Kopie/Nachbildung.

Bis dato wurden in NW-Pannonien über 100 unterschiedliche Stempeldekore belegt (Taf. 9–11). Sie kommen als Einzelmotiv oder als Komposition vor, letztere zusammengesetzt aus drei oder vier gleichen Motiven oder aus jeweils Zweier- oder Dreier-Gruppen mit unterschiedlichen Motiven. Der Anteil der Gefäße mit Stempeldekore im PGW-Bestand pro Grabung beträgt 1–9 %. Eine gesicherte Zuweisung einzelner Motive an eine bestimmte Werkstatt kann derzeit noch nicht erfolgen. Ausgehend von Scherbentypen (STypen) und Motiven kann aber eine vorläufige Differenzierung von Importen aus NO-Pannonien und lokalen Produkten NW-Pannoniens vorgeschlagen werden. Die Importe stellen dabei den kleineren Teil der Stempeldekore (s. dazu Kap. I.2). Der verbleibende Großteil der Stempeldekore wahrscheinlich westpannonischer Provenienz besteht in erster Linie aus Palmblatt-Motiven, Rosetten, gerundeten (breit-eiförmigen) Blättern, dreilappigen Blättern und weiteren Blattformen (Taf. 9.–10.I–IV, VI–VIII).³ Alle weiteren Motive (Taf. 10–11, IX–XIX) kommen nur sporadisch vor. Die Palmblätter und Rosetten sind meistens auf der Außenwand von Gefäßen eingestempelt, die gerundeten Blätter auf der Bodeninnenseite, wenn auch dies keinesfalls die Regel darstellt. Auch sind in NW-Pannonien zwar in einer überwiegenden Mehrzahl Gefäße mit Bodeninnenstempelung anzutreffen, dies ist aber ebenfalls nicht die Regel. Namensstempel, als *planta pedis* oder in Kartuschen, sind in NW-Pannonien sehr selten; bei jenen in Kartuschen handelt es sich wahrscheinlich um Importe. In der Regel wurde auf der Bodeninnenseite von Breitformen gestempelt (Teller, Schalen, Schüsseln), während die Außenstempelung auf Hochgefäßen angewandt wurde (hohe Schüssel- und Schalenformen, Becher). Manche Gefäßformen wurden nie oder kaum gestempelt: keine Stempel finden sich auf den Knickwandtellern Te 4, kaum Stempeldekore auf den Tellern Te 7 (Schalen Sa 7 aber schon) und Te 8 (in NO- und in SW-Pannonien ebenso wie in SO-Noricum finden sich auch gestempelte Exemplare). Wir können derzeit nicht nachvollziehen, warum bei übereinstimmendem Form- und Scherbentyp manche Exemplare gestempelt sind, andere wiederum nicht.

Im Unterschied zu den Gefäßformen, die großteils eine klare römische bzw. TS-Prägung aufweisen, sind die meisten Stempeldekore auf Gefäßen NW-Pannoniens ebenso wie ihre Anbringung auf der Bodeninnenseite vorrömischen bzw. italischen, oder generell hellenistischen Ursprungs. Rosetten, Palmblätter und dreilappige Blätter finden sich bereits in der *ceramica a vernice nera*, während andere Motive, wie Tiergestalten (Hirsch) oder Girlande, wahrscheinlich erst aus der jüngeren TS, sei es der italischen, sei es der gallischen, in das Motivspektrum der PGW NW-Pannoniens übernommen wurden (s. dazu Kap. III.1).

2 Für Entsprechungen in anderen Waren und zu den Vorbildern einzelner Formen der PGW s. Berger-Pavić 2021a: Tab. 3.

3 Für Fotos s. <https://stadtarchaologie.at/start/erleben/ausstellungen/schnoerker/schnoerker-3/schnoerker/> Nr. 1–13 (3.10.2020), Gassner 1993, Adler-Wölfl 2004: Abb. 27–30, Pavić 2004, Nagy 2017: Abb. 15, Berger-Pavić 2021a.

Bei den jüngeren (?) Stempelmotiven kam es zur Stilisierung. Manche Gefäße im Nordosten und Südosten Pannoniens sind bereits so mit unterschiedlichen und vielen Motiven überladen, dass die Motive zu Ornamenten wurden. Im Nordwesten ist keine parallele Entwicklung bei den Stempelgefäßen zu beobachten, hier hörte die Verzierung mit Stempeldekoren bereits im Laufe des 2. Jhs. n. Chr. auf (um 160. n. Chr.).

Motiv	Taf.	Vorkommen im NW	Herstellung im NW	Pannonien
I. Palmblätter. Mehrere Varianten und Größen (7)	Taf. 9	in Vindobona sehr häufig, in Carnuntum weniger häufig	Vindobona, Carnuntum?	sehr häufig, überall, bes. im NW und SW
II. Rosetten. Mehrere Varianten und Größen (8)	Taf. 9	sehr häufig	Vindobona; Carnuntum (STyp 5).	sehr häufig, überall
III. Eiförmige Blätter	Taf. 9	sehr häufig	Carnuntum?, Salla, Vindobona	außerhalb vom NW selten bis kaum
IV. Breit-eiförmige Blätter	Taf. 9	häufig	Salla?	nur im NW
V. Palmette oder palmettenähnliches Blatt	Taf. 9	sehr selten	Vindobona oder Carnuntum	selten
VI. Dreilappige Blätter	Taf. 10	mittelhäufig	Vindobona?	mittelhäufig
VII. Verschiedene Blätter	Taf. 10	sehr häufig	Vindobona	sehr häufig
VIII. Spitzblatt. Mehrere Varianten und Größen	Taf. 10	mittelhäufig		häufig
IX. Zapfen	Taf. 10	selten, Vindobona Klosterneuburg	Vindobona?	selten?
X. Herzblatt	Taf. 10	selten	Vindobona?	mittelhäufig
XI. Knospe?	Taf. 10	selten, Carnuntum, Savaria		selten
XII. Doppelblatt/Deltoid /Drachenviereck	Taf. 10	selten	Vindobona?	selten
XIII. Rhombus/Raute	Taf. 11	sehr häufig, Vindobona, Carnuntum, Salla	Carnuntum (STyp 2)? Vindobona?	sehr häufig, viele Varianten
XIV. Kreuzmotive	Taf. 11	selten, Carnuntum	Carnuntum	mittelhäufig NW, NO, SO
XV. Girlande. Zahlreiche Varianten und zwei Größen	Taf. 11	mittelhäufig	Vindobona?	sehr häufig NW, NO, SW, SO
XVI. Lunula mit Öse	Taf. 11	selten	Carnuntum	selten
XVII. Omega-Motiv	Taf. 11	selten, Vindobona, Carnuntum	Vindobona?	selten
XVIII. Figürliche Motive. Tiere	Taf. 11	selten, Vindobona	Vindobona (STyp 26')?	relativ häufig im NO
XIX.1. Namensstempel in <i>planta pedis</i>	Taf. 11	sehr selten, Vindobona, Carnuntum	Carnuntum (CRESCe)?**	selten im NW, SW, im NO, Aquincum dehr häufig
XIX.2. Namensstempel in Kartusche	Taf. 11	sehr selten, Vindobona, Import?		NO, SO
Weitere Motive	Taf. 11	anepigraphisches <i>planta-pedis</i> -Motiv federähnliches Blatt Flaschenkürbisförmiges Motiv		selten häufig im NO, SO selten

Tab. 1 Stempelmotive nach Gruppen (in Klammern die Anzahl der Typen), ihr Vorkommen in NW-Pannonien (*Carnuntum* und *Vindobona*) und ihre Häufigkeit in den vier pannonischen PGW-Gruppen. Tabelle in Arbeit.

* Der STyp 26 aus *Vindobona*, Rennweg 44, ähnelt dem STyp der Gefäße, die in den *Canabae* von *Vindobona* hergestellt wurden (Kronberger 2004).
 ** Gassner 1993: 373; Adler-Wölfl 2004: 97 f.

I.1 VINDOBONA

Lokale Produktion, Formenspektrum, Stempelmotive, Datierung, Importe

Für *Vindobona* liegen zahlreiche Hinweise ebenso wie konkrete Nachweise für lokale Keramikproduktionen vor (Abb. 1),⁴ dazu sind auch die Indizien für eine Herstellung von PGW in den *Canabae* sowie in der Zivilstadt zu zählen. Eine Rekonstruktion der PGW-Produktion am Wiener Neuen Markt/Spiegelgasse anhand der Unterlagen der Altgrabungen wurde von Michaela Kronberger durchgeführt (Kronberger 2004). Die Autorin rekonstruierte für diesen Fundort eine Produktion von Schrägwandschüsseln (Sü 1), Rundwandschüsseln (Sü 2) und Kragenrandschüsseln (Sü 2.7) (Kronberger 2004: Taf. 1–3; hier Taf. 12: Neuer Markt). Weitere Hinweise für PGW-Herstellungen betreffen die Keramiköfen, die am Rennweg, d. h. in der Zivilstadt, festgestellt wurden (Adler-Wölfl 2004: 97–99; Chinelli 2018a: 525–528). Vom Areal der Zivilstadt (Aspangstrasse) stammt auch eine Stempelmatrize mit einem breit-eiförmigem Blatt (Abb. 2).

Die geologischen bzw. petrographischen Analysen legten nahe, dass einige Scherbentypen der PGW aus *Vindobona* in der Zusammensetzung dem lokalem Ton etwa vom Hernalser Tegel im Wiener 17. Bezirk entsprechen (Sauer 2021: 357 f., Petrographischer Scherbentyp RWGT-B und B1). Dabei handelt es sich um die oxidierend gebrannte STypen GT 24 und GT 25 der Grabung Rennweg 44 in der Zivilstadt *Vindobona*. Die bis dato bekannten Gefäßformen dieser zwei STypen aus der Zivilstadt wurden auf Taf. 12 zusammengestellt. Der für Carnuntum festgestellte STyp GT 11 weist große Ähnlichkeit zu dem vindobonensischen STyp GT 25 auf; es muss vorläufig offen bleiben, ob es sich hierbei um zwei ähnliche oder denselben STyp handelt, und ob in letzterem Fall dieser STyp auf eine Wiener oder eine Carnuntiner Produktion verweist.

In zukünftigen Untersuchungen soll das Augenmerk auf einen Vergleich des PGW-Spektrums aus Legionslager, *Canabae* und Zivilstadt gelegt werden, ebenso wie auf eine Gegenüberstellung der Produktionen aus Zivilstadt und den *Canabae*.



Abb. 1 Vindobona. Lageplan der Keramiköfen und der Keramikproduktion. Stand 2018 (© Stadtarchäologie Wien)

⁴ Für die lokale Herstellung der oxidierend gebrannten Gebrauchsware s. Chinelli 2018a und Chinelli 2018b.

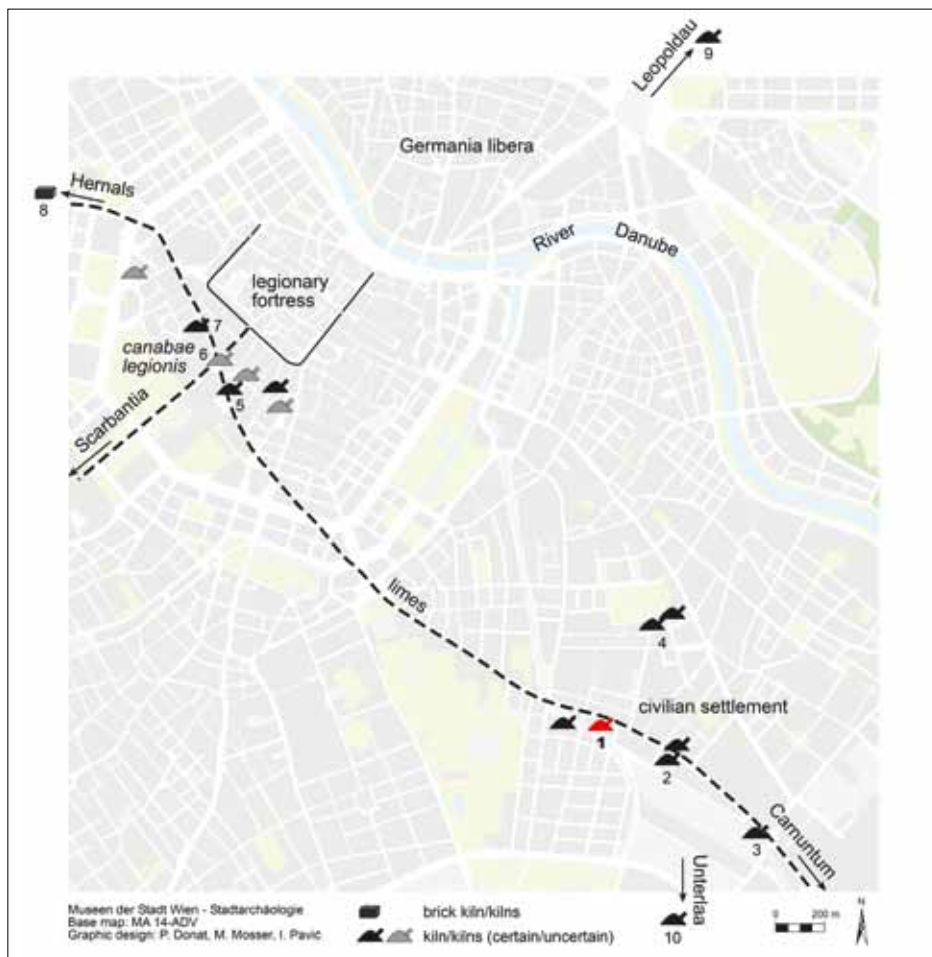

Abb. 2 *Vindobona*. Eine Handpunze aus der Zivilstadt (nach Kronberger 2004: 101 Abb. 14).

1.2 CARNUNTUM

Lokale Produktion, Formenspektrum, Stempelmotive, Datierung, Importe

Wie eingangs erwähnt liegen aus *Carnuntum* tausende Gefäße und Gefäßfragmente der PGW vor. Fehlbrände, Ofenfunde oder Werkstättenbereiche, die eine lokale Herstellung von PGW direkt belegen, fehlen bis jetzt.

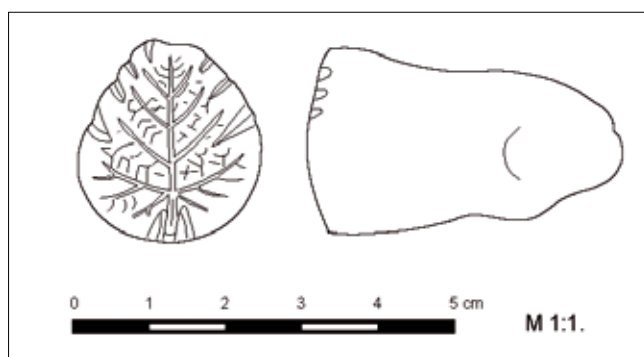
Durch makro- und mikroskopische Untersuchungen sowie petrographische Analysen bzw. Dünnschliffanalysen wurde die Präsenz von mehreren STypen verschiedener Provenienz in der Zivilstadt *Carnuntum* nachgewiesen, von denen einige ausweislich eines Abgleichs mit den in *Carnuntum* oder Umgebung vorhandenen Tonlagerstätten als mögliche lokale STypen angesehen wurden. Auch wurde im Auxiliarkastell die Herstellung von fein- und grobtoniger Gebrauchsware dokumentiert: Aus einer Ofenverfüllung stammen ca. 60 oxidierend gebrannte und ungebrannte Gefäße, darunter Formen der „Legionskeramik“, und andere Gegenstände aus Ton (Gassner et al. 1997). Der Befund ist in das 3. Drittel des 2. Jhs. n. Chr. datiert. Von den fünf festgestellten STypen (A–E) wurde ein STyp in der PGW möglicherweise identifiziert, während die Identifizierung von zwei weiteren STypen fraglich ist (s. weiter unten und Tab. 2).

In der ersten monographischen Behandlung von PGW⁵ wurde das reduzierend gebrannte Material aus dem Auxiliarkastell *Carnuntum* (423 Gefäße) publiziert (Adler-Wöfl 2004). Einige wenige oxidierend gebrannte Stücke, die mitveröffentlicht wurden, stellen Importe dar (s. weiter unten und Abb. 4). Kristina Adler-Wöfl differenzierte durch mikro- und makroskopische sowie petrographische und geologische Analysen – durchgeführt von Roman Sauer – fünf Scherbentypen. Der von ihr festgestellte STyp 2, möglicherweise aber auch die STypen 3 und 5, sind mutmaßlich lokaler Provenienz, da ihre Schwermineralzusammensetzung jener eines Sarmattegels aus dem Raum *Carnuntum* ähnelt (Adler-Wöfl 2004: 20–29, 79). Der erwähnte STyp 2 ist durch 280 Stücke belegt und weist folgendes Formenspektrum auf: Rundwandteller mit eingebogenem Rand (Te 2.4) und mit Horizontalrand (Te 2.5), Teller mit Standfläche und ausschwingender Wandung (Te 7.3), Rundwandschalen mit eingebogenem Rand (Sa 2.4) und mit Horizontalrand (Sa 2.5), Schrägwandschüsseln (Sü 1.2), Rundwandschüsseln (Sü 2.1, Sü 2.2 und Sü 2.3), halbkugelige Schüsseln (Sü 5.2), Ringschüsseln (Sü 6.1 und 6.2) sowie Becher mit Schrägrand (Be 1.4) und Töpfe mit konischem Hals (To 6.1) (Taf. 13) (Adler-Wöfl 2004: 80–83 mit Tab. 7–8).

Für die Zivilstadt konnte die Verfasserin mehr als 20 unterschiedliche Scherbentypen feststellen (Berger-Pavić, im Druck). Zwar sind alle aus dem Auxiliarkastell bekannten STypen auch hier präsent und in der Auswertung ergaben sich zahlreiche Übereinstimmungen in Formen und Datierungen (Berger-Pavić, im Druck), dennoch sind große Unterschiede im Material festzustellen. Neben dem Auftreten von neuen STypen (STypen GT 6–GT 20) und Formen (Te/Sü 4.9, Te 8, Sü 6b.2 mit kurzem Oberteil, Sü 6.5, Sa 2.3, Sa 7.4/5, Sa 9, Be 1c.2, „Siebe“ und Deckel), sind auch Unterschiede in den Belegzahlen zu den einzelnen Gefäßformen und Stypen zu konstatieren. Auch ist der Anteil der stempelverzierten Gefäße in der Zivilstadt viel niedriger.

Typologische Untersuchungen in Kombination mit petrographischen Analysen und unter Einbeziehung der bisherigen Forschungen (Petznek, Radbauer 2004 und Adler-Wöfl 2004: STyp 2.) erlauben sämtliche Ringschüsseln- und schalen jüngerer Ausprägung (Sü/Sa 6b.2), hergestellt in den STypen GT 3.2–3.3, GT 14 und GT 15, als lokal anzusehen (Taf. 14; Berger-Pavić, im Druck). Dabei handelt es sich um reduzierend (STypen GT 3.2–3.3, GT 14) und selten oxidierend (STyp GT 15) gebrannte Gefäße, die durch eine bikonische Wandung gekennzeichnet sind. Der Oberteil ist kurz und verläuft oft senkrecht, der Unterteil nach dem Ring konisch. Ein zwei- oder dreizonales Dekor aus breiten Ratterbändern, angebracht

5 Die Arbeit von L. Nagy blieb ein Manuskript, aus dem später eine Typentafel veröffentlicht wurde.

auf der Außen- und Innenwand, ist für diese Gefäßproduktion charakteristisch. Die Gefäße weisen keine Stempelverzierung auf und der Überzug ist – soweit vorhanden – matt, rau und gelegentlich nur noch im oberen Drittel der Außenwandung vorhanden. Einige Gefäße weisen Glättspuren auf. Bei einigen flachen Exemplaren handelt es sich wahrscheinlich um Deckel. Die Produktion dieser Gefäße erfolgte im späten 3. Jh. n. Chr. (Petznek, Radbauer 2004: 45 f.). Ob und wie lange diese noch im Laufe des 4. Jhs. n. Chr. hergestellt wurden, ist nicht bekannt. Ab ca. 350/375 n. Chr. sollen sie nicht mehr im Umlauf sein (Petznek, Radbauer 2004: 45).



Abb. 3 Carnuntum. Scherbentypen GT 3.1 und GT 3.2.

Zu den lokalen STypen sind weiters die STypen GT 3.1 und GT 16 zu zählen, beide in Modus A gebrannt. STyp GT 3.1 ist die oxidierend gebrannte Variante des STyps GT 3.2–3.3 (entspricht dem Adler-Wölfl STyp 3 aus dem Auxiliarkastell). STyp GT 16.1 ist ähnlich dem STyp C aus dem Ofen in Auxiliarkastell (Gassner et al. 1997: 192; 261 Farbentafel 1.6–7). In diesen STypen wurden die Schüsseln und Schalen mit kragenähnlichem Ring (Sü/Sa 9) und weitere Varianten von Ringschüsseln (Sü 6) hergestellt (Taf. 14).

Als wahrscheinlich lokaler STyp ist auch der STyp GT 11 anzusehen (Berger-Pavić, im Druck). Dieser ist dem STyp GT 25 aus *Vindobona* (s. oben) sehr ähnlich oder gleich. Tonlagerstätten ähnlicher geologischer Herkunft und mineralogischer Zusammensetzung sind an beiden Orten vorhanden (vgl. Sauer 2021: 358, Petrographischer Scherbentyp RWGT-B1, STyp GT 25). In STyp GT 11 wurden Teller (Te 4.9 und Te 2.4), Schalen (Sa 2.4 und Sa 3) sowie halbkugelige Schüsseln (Sü 5), Rundwandschüsseln (Sü 2) und Ringschüsseln (Sü 6) hergestellt (Taf. 14).

Als weiterer möglicherweise lokaler STyp ist der kalkreiche STyp GT 6 anzusprechen, in dem u.a. Schüsseln mit halbkugelige Wandung (Sü/Sa 5; vgl. Drag. 37) und Ratterdekor vorliegen (Taf. 14). Dieser STyp ähnelt STyp GT 24 aus *Vindobona*.

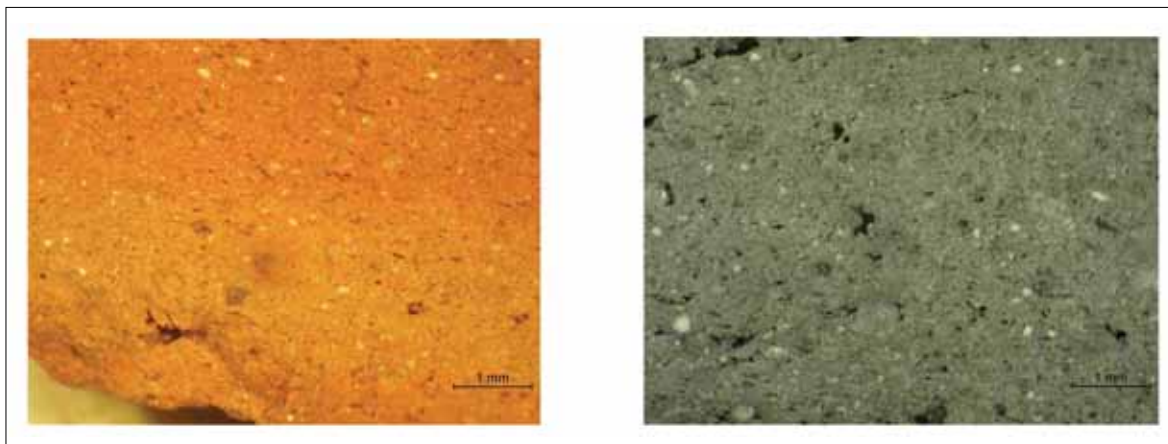
Abschließend konnten auch Proben aus *Carnuntum* und *Vindobona* mit jenen der Resatus-Gefäße aus *Aquincum* verglichen werden. Die letztgenannten stellte dankenderweise Alexandra Nagy (Aquincum Museum) zur Verfügung. Bei mikroskopischen Analysen beobachtete die Verfasserin einen hohen Grad an Ähnlichkeiten zwischen den Resatus-Gefäßen und den STypen 2, 22, 24, 26 und 27 aus *Vindobona* und *Carnuntum* fest. Durch die anschließenden Dünnschliff-Analysen der Stücke und ihre Interpretation durch Roman Sauer wurden aber deutliche Unterschiede zwischen den beiden Gruppen festgestellt. Die Unterschiede betreffen u.a. das Auftreten von spezifischen Foraminiferen (in den Proben von *Aquincum*) sowie auch quantitativen Unterschieden bei den natürlichen Magerungspartikeln (Menge, Korngröße, etc.). Dies bedeutet, dass die angenommene lokale Herkunft der angeführten STypen aus *Vindobona* und *Carnuntum* derzeit aufrecht erhalten bleibt. Analysen von weiteren STypen aus *Carnuntum* (STypen GT 6–20) wurden noch nicht gemacht, so dass diese STypen nicht mit jenen aus *Aquincum* verglichen werden konnten. Außerdem ist mit weiteren STypen aus *Aquincum* zu rechnen.

Vergleichende Untersuchungen des Materials aus dem Legionslager, dem Auxiliarkastell und der Zivilstadt, wurden bis dato nicht durchgeführt. Doch weisen schon die neu dazugekommenen Scherbentypen wie Gefäßformen auf Unterschiede in der Materialzusammensetzung hin. Liegen aus dem Auxiliarkastell und teilweise aus dem Legionslager bzw. seinem Suburbium zahlreiche stempelverzierte Stücke vor, ist ihre Anzahl aus der Zivilstadt viel geringerer. Im Formenspektrum der PGW aus dem Auxiliarkastell sind am häufigsten Teller (Te 2.4; vgl. Drag. 36), Teller mit Standfläche

(Te 7), Rundwandschüsseln (Sü 2) sowie Ringschüsseln (Sü 6) belegt. Auch sind relativ viele Becherformen vertreten (fragmentiert).

In der Zivilstadt überwiegen eindeutig jüngere Formen. Das Formenspektrum ist dennoch breit gefächert: es kommen Teller (Te 2.4, Te 2.5, Te 2.6), Schüsseln (Sü 1, Sü 2, Sü 4, Sü 5, Sü 6), Schalen (Sa 1, Sa 2, Sa 5, Sa 6), Becher (darunter Imitationen mehrerer Feinware-Formen wie Niederbieber 33, mit oder ohne Dellen) sowie in geringerer Anzahl Töpfe, Deckel und „Siebgefäße“ vor.

Gassner 1993	Gr. 4	Gr.1–3				tw.Gr. 1					
Gassner et al. 1997				A?			A?	B?			C
Petznek 2000	P3	P1–P2	P4		P5						
Adler-Wölfl 2004	STyp 2A	STyp 2B	STyp 2C		STyp 3	STyp 5					
Petznek, Radbauer 2004	STyp 1?	STyp 1?	STyp 1?						STyp 2		
Berger-Pavić 2016							D?				
Berger-Pavić, im Druck	GT 2	GT 2	GT 2	GT 3.1	GT 3.2–3	GT 5	GT 6	GT 11	GT 14	GT 15.2	GT 16.1

Tab. 2 Konkordanztabelle der lokalen Scherbentypen aus Carnuntum⁶.

Importstücke aus Vindobona und Carnuntum

Die lokale Herstellung von PGW in Vindobona und Carnuntum ist zum großen Teil noch nicht erschlossen. Auch ist die Trennung der beiden Produktionen aufgrund eines ähnlichen STyps unsicher. Die Ergebnisse bisheriger Untersuchungen ermöglichten aber, die mutmaßlich lokal produzierten von den vermutlich importierten Gefäßen zu unterscheiden. Dabei ist in erster Linie von den STypen auszugehen: die STypen in Wien und Carnuntum sind kalkreich oder kalkgemagert, während alle kalkfreien oder kalkarmen STypen regionale Importe oder Importe aus NO-Pannonien sind (zu diesen gehört beispielsweise ein STyp aus Savaria, sowie ein STyp aus NO-Pannonien - Aquincum?).

Stempeldekore und Gefäßformen spielen in der Feststellung von Importen ebenfalls eine wichtige Rolle, soweit es sich um spezifische Motive oder Dekorkombinationen handelt. Zu den Stempelmotiven, die mit ziemlicher Sicherheit Importe kennzeichnen, gehören in Westpannonien seltene Motive wie der Eierstab, die „Sanduhr“, einige Girlanden-Motive und eventuell auch die in Anlehnung an die Resatus-Blätter aus Aquincum entstandenen „federähnlichen Blätter“. Die mutmaßlichen Importstücke sind zudem durch bestimmte, auf der Außenwand aufgebrachte Motivkombinationen von Eierstab, großen Blättern, Hasen etc. gekennzeichnet, wie sie auf vielen Gefäßen aus Aquincum, Gorsium und Brigetio zu finden sind (Nagy 2017; Bánki 1998; Fényes 2003). Bei anderen seltenen, für NW-Pannonien belegten Motiven, wie die gepunkteten Herzblätter und Kreuz-Motive, ist die Provenienz noch unklar, doch sind die STypen zum Teil lokal.

Eine bessere Identifizierung von Importen aus NO-Pannonien bzw. Aquincum nach Vindobona und Carnuntum ermöglichte die Publikation von Alexandra Nagy (2017) mit einem Katalog mit über 1000 Gefäßen und einigen Hundert einzelner Motiven mit Abbildung. Laut ihrer Aussage lassen sich bei den hier aufgelisteten Stempelmotiven (Abb. 4–6, 8) trotz Ähnlichkeiten nur die Motive Abb. 4 Aquincum und der Resatus-Werkstätte oder dem Kreis um Resatus zuordnen.⁷

Importstücke aus Carnuntum



Abb. 4a-b. Carnuntum, Auxiliarkastell, Halbkugelige Schüsseln Sü 5 mit Außenwandstempelung (Adler-Wölfl 2004: 79 Abb. 30). Das Dekor besteht aus Eierstab, kleinen dreilappigen Blättern und gepunkteten Rauten (Abb. 4a). Importe aus Aquincum⁸. Für die Raute s. Nagy 2017: Tab. 75 U40.

6 Scherbentypen nach: Gassner 1993: 362 f.; Gassner et al. 1997: 191–194, 246–268; Petznek 2000: 97 f.; Adler-Wölfl 2004: 21–29 mit Konkordanztabelle Tab. 3; Petznek, Radbauer 2004: 45–49; Berger-Pavić 2016: STyp D; Berger-Pavić 2021b: STypen 1–23.

7 Freundliche Mitteilung von Alexandra Nagy, Aquincum Museum Budapest, der ich an dieser Stelle herzlich danke.

8 s. dazu Nagy 2017: 15, Anm. 58.

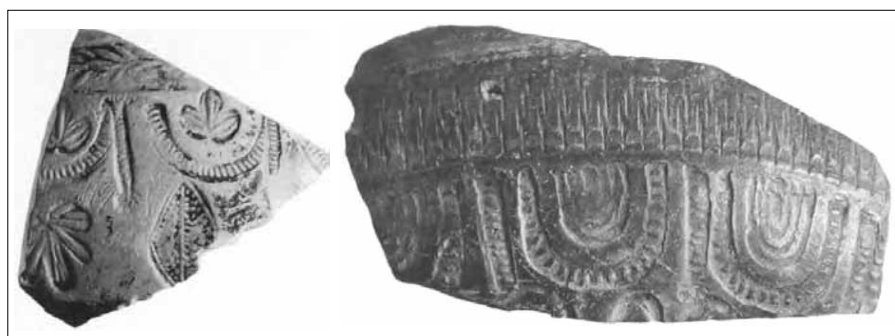

Abb. 5. Carnuntum, Zivilstadt (Haus IV), lokale Herstellung oder Import aus *Vindobona*. Das Dekor besteht aus Omegamotiven, Girlanden, Palmetten und gepunkteten Herzblättern. Ähnliche, aber nicht gleiche Motive liegen aus *Vindobona*, Palais Harrach (unpubl.), *Carnuntum* (Herzblatt und Omega/Lunulamotiv: Gassner 1993: Taf. 4.20), *Gorsium* (gepunktetes Herzblatt: Fitz – Bánki 1974: Taf. 11.2) und eventuell *Salla* (ähnliche Kompositionen⁹) vor. Aufgrund von Ausschlusskriterien (belegte Produktionen und Motive) und vor allem des STypes (GT 25) ist das Gefäß entweder lokal oder – wahrscheinlicher – in *Vindobona* hergestellt worden.



Abb. 6. Kreuz-Motive kommen in *Carnuntum* auf zwei Gefäßen vor. Eines, in Kombination mit Girlanden (Taf. 11.XIV.2), ist möglicherweise lokaler Herstellung, das andere, hier Abb. 6 (Taf. 11.XIV.1), ist ein Import, vielleicht aus Ostpannonien. Kreuzmotive sind aus NO-Pannonien (*Gorsium*: Kocztur 1974: Taf. 22.323, 325; *Aquincum*: Nagy 2017: Taf. 73 T15, Taf. 74 U31 und Taf. 75 U33) und SO-Pannonien (*Sirmium*: Dautova-Ruševljan 1996: Taf. 12.2) bekannt.



Abb. 7. *Carnuntum* (Zivilstadthermen). Die Schüsselform mit tief sitzender Rille auf der Innen- und Außenwand sowie niedrigem Standring, wie für die Resatus-Schüsseln *Aquincumer* Produktion charakteristisch (s. Nagy 2017: Taf. 1.1–2), weist diese Schüssel als möglichen Import aus *Aquincum* aus.

Importstücke aus *Vindobona*

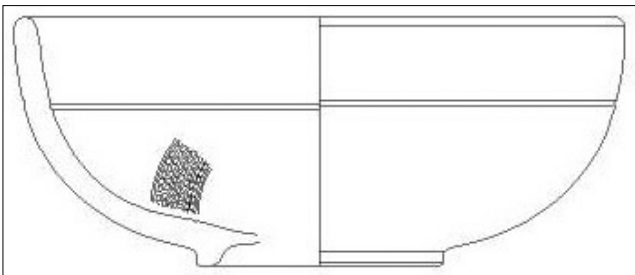

Abb. 8. *Vindobona*, Michaelerplatz, federähnliches Blatt. Ein ähnliches Stempelmotiv ist aus *Gorsium* bekannt (Bánki 1998, Taf. 4.144, Taf. 17.149), aber auch im Südosten der Provinz kommen verwandte Motive vor. Eventuell ist hier mit einem Import aus Ostpannonien zu rechnen.

Zu den weiteren Importen nach *Vindobona* gehören wahrscheinlich auch einige Namensstempel. So ist der Namenstempel vom Michaelerplatz, auf dem noch zwei oder drei Buchstaben sichtbar sind ((I)V.S[...] oder [...]S.A(I): Taf. 11.XIX.2¹⁰) eventuell als *RESATUS FECIT* zu ergänzen (vgl. Nagy, Beszedes 2009: 392 f.) und als Importstück aus *Aquincum* anzusehen.

9 s. Maróti 1987a.

10 Pavić 2004: Taf. 5.8, 12.IX.3, hier jedoch kopfüber abgebildet.

II. PANNONIEN UND DIE PANNONISCHE GLANZTONWARE

II.1 SCHLÜSSELDATEN

Herstellungstechnik: (schnelldrehende) Töpferscheibe. Einzelne Stempeldekore wurden mittels einer Handpunze, wie jene auf Abb. 2, aufgedruckt.¹¹ Ähnlich wie bei Gemmen, wurden Motive auf Handpunzen in zwei Modi geschnitten: in negativ (*intaglio*), wo das Motiv eingetieft ist und in positiv (*kamee*) mit erhaben geschnittenem Motiv. Eine „Negative“-Punze ergab beim Stempeln erhabene Motive und eine „Positive“-Punze eingetiefte Motive bzw. Dekore. In der PGW war vorherrschend die Negativ-Schnitttechnik in Anwendung. Bei den beiden Techniken waren die Schnitte üblicherweise flach und dünn und ergaben Stempelmotive im Flachrelief. An einigen Gefäßen der SW-Gruppe sowie in Dakien (s. Kap. III.2 Dakien) erscheinen die Motive aber im Tiefrelief. Ob diese Dekore mit einer Punze oder mit Hilfe anderer Werkzeuge ausgeführt wurden, wie etwa mit einem Kerbeisen mit dreieckigem Profil oder einem Roller muss vorerst offen bleiben.

Die Frage, ob in Pannonien auch Modeln/Formschüsseln in der Herstellung von PGW-Gefäßen mit laufenden Dekoren zum Einsatz kamen, ist für *Aquincum* zu verneinen¹². Solche Modeln liegen in Pannonien vereinzelt u. a. aus Mursa und Cibalae vor. In größerer Anzahl sind sie für *Aquincum* festzustellen (s. Kuzsinszky 1932: 123–153 Abb. 94–153), wo sie, nach stilistischen Merkmalen zu urteilen, in der Herstellung von TS verwendet wurden. Da jedoch in anderen Provinzen, besonders Gallien, Formschüsseln gefunden wurden¹³, deren Dekore jenen der PGW entsprechen (Palmbblatt- und Rosettenfriese), ist die gestellte Frage nicht abwegig. Dabei würde es sich zwar nicht um gestempelte Gefäße handeln, aber immerhin um Glanztonware.

Herstellung/Brand: die Keramik wurde in zwei Modi, A und B hergestellt (über die Modi s. Picon 2002: bes. 139–147), die konventionell oxidierender (A) und reduzierender (B) Brand genannt werden, sowie in Mischmodus (oxidierend-reduzierend/AB oder *vice versa*).

Dekore: Ratterdekor und Kerbschnitt, Stempeldekor, Barbotinedekor, aufgedruckte Gemmen (?)

Bei der Herstellung von Glanztonware wurden in den meisten Fällen zwei Dekorarten angewandt: Ratterdekor bzw. seltener Kerbschnitt sowie Stempeldekor. Ratterdekor ist auf den meisten Gefäßen zu finden und wenn Stempeldekor angebracht wurde, so in Kombination mit Ratterdekor. Barbotinedekor kommt sehr selten vor und findet sich etwa an den „Tropfen-Bechern“ oder den zylindrischen Bechern mit Barbotinegranulae. Eine „Gemmen-Stempelung“, bekannt aus Italien und Gallien, wurde in Pannonien in Sirmium und eventuell in *Aquincum* angewandt¹⁴. Es ist jedoch unklar, ob die Stempelung mittels Gemmen ausgeführt wurde, oder ob dafür Handpunzen zum Einsatz kamen, die Gemmen in Form und Dekor imitierten.

Oberflächenbehandlung und Überzug: Es kommen verschiedene Arten und Qualitäten von Überzug vor, von einem hochglänzenden Überzug über einen mattglänzenden Überzug bis zum self slip und Gefäßen mit partiell geglätteter Oberfläche sowie jenen ohne jeglichen Überzug.

Die Oberflächenqualität kann auch beim gleichen STyp unterschiedlich sein. Schlechte Witterungsverhältnisse sind vermutlich der Grund, dass die Mehrzahl der PGW-Gefäße aus *Carnuntum* mit abgeriebenem Überzug und sandigem (sandig gewordenem) Ton geborgen wurde. Bei Funden aus Gräbern ist generell mit einem besseren Erhaltungszustand zu rechnen.

Nichtdestotrotz ist für die PGW aus Mursa und Siscia charakteristisch, dass sie eine außerordentlich gute, TS-ähnliche Qualität aufweist. Der Scherben der Stücke aus Siscia ist sehr hell (gelblich?) und jener aus Mursa hellgrau (?) gebrannt.

Ton und Scherbentypen: die Verfasserin hat bisher etwa 30 unterschiedliche STypen in *Vindobona* und *Carnuntum* feststellen können. Auch wenn pro Werkstätte oder Produktionsort mehrere STypen anzunehmen sind, weist dies auf eine größere Anzahl lokaler und regionaler Herstellungsorte bzw. Ateliers hin. Bislang konnten nur wenige STypen einem bestimmten Herstellungsort zugewiesen werden (Zuweisungen gelangen für *Savaria*, vielleicht *Salla*, *Vindobona* und *Carnuntum*). Dabei spielten auch andere Waren/Keramiken eine große Rolle, ebenso wie die Untersuchung von Tonlagerstätten in der Umgebung.

Datierung: Der Produktionsbeginn der PGW ist zwischen 70 und 100 n. Chr. anzusetzen, das Ende im späten 3. Jh. oder 4. Jh. n. Chr.

11 Für Punzen aus *Poetovio* vgl. Tomanič-Jevremov 2004: 19 f. Abb. 27–30.

12 Nagy 2017, 31–33.

13 Vgl. etwa Bourbon-Lancy: Rouvier-Jeanlin 1990: 148 Abb. 65.

14 Vgl. Brukner 1981: Taf. 51.17, Dautova- Ruševljan 1996: Taf. 7.6 (Sirmium); Nagy 2017: Taf. 80 Y1–Y8 und Taf. 76 W1–W4 (*Aquincum*).

Für NW-Pannonien können drei Zeitperioden unterschieden werden:

1. vor 100 – ca. 150 n. Chr. Die meisten Gefäße mit Bodeninnenstempelung gehören dieser Periode an.

2. ca. 150 – ca. 200/230 n. Chr.

3. ca. 230/260 – ca. 360/ n. Chr. In der NW-Gruppe bzw. in *Carnuntum* werden in dieser Zeit fast ausschließlich Ringschüsseln jüngerer Ausprägung hergestellt, überwiegend in Modus B gebrannt. Im Gebrauch sind noch die Teller mit Standfläche und gerundetem, eingebogenem Rand (Te 8b). Es wurden keine gestempelte Gefäße mehr produziert (vereinzelt Altstücke). Der Überzug dieser späten PGW ist matt oder nicht existent. Überall reduziert sich das Formenspektrum auf wenige Formen.

II.2 DIE GRUPPEN, IHRE CHARAKTERISTIKA UND MÖGLICHE WEGE DER ÜBERTRAGUNG

Die Forschung konnte vier Hauptgruppen der PGW festhalten, die ungefähr die vier Vierteln der Provinz Pannonien abdecken: die NW-Gruppe, die NO-Gruppe, die SW-Gruppe¹⁵ und die SO-Gruppe.¹⁶ Diese Gruppen entsprechen dem Wirkungskreis einzelner Werkstätten und es wäre möglicherweise praktikabler, sie nach den führenden Werkstätten zu benennen. Es ist derzeit jedoch noch nicht möglich, alle Charakteristika der Gruppen oder Werkstätten festzuhalten, da das Material, mit Ausnahme von einigen Gebieten, wie NW- und NO-Pannonien nicht ausreichend publiziert oder gegebenenfalls systematisiert ist. Für den NW und SW besteht auch das Problem, dass die Werkstätten zum Teil noch nicht erschlossen sind.

1.NW/Nordwesten – wichtige Fundorte und/oder Produktionsorte: *Vindobona*, *Carnuntum*, *Savaria* und *Salla*. Auch *Poetovio* gehört stilistisch hierher, obwohl es im Südwesten liegt.

Charakteristika: generell meist Stempelung auf der Bodeninnenseite, aber in *Vindobona* wie auch in *Salla* relativ viele Gefäße mit Stempelung der Außenwand

Motive: gerundete (breit-eiförmige) Blätter, Palmblätter, Rosetten, aber auch Rhombus, Girlande und weitere Blattmotive. Sehr selten sind figurale Darstellungen (Tiere) und Namenstempel (als *planta pedis* und in Kartusche). Kein Eierstab.

Gefäßtypen und Formen: Teller, Schüsseln, Schalen, Becher, Töpfe, Deckel, Gefäße mit gelochter Einlage („Siebe“).

Sehr große Varianz an Formen, großteils Nachbildungen von Terra Sigillata, etwa Te/Sa 2.4 (Drag. 36) und Sa/Sü 5 (Drag. 37). Sodann großzügige Imitationen verschiedener TS-Formen wie auch anderer Keramiken/Waren, wie die Schrägwandschalen/schüsseln (Sa/Sü 1), Rundwandschalen- und schüsseln (Sa/Sü 2), Teller mit Horizontalrand und Standring (Te 2.5), Teller mit ausschwingender Wandung und Standplatte (Te 7), Ringschüsseln (Sü 6) sowie Kragenschalen (Sa 9), Becher verschiedener Wandungs- und Randformen wie konischer Becher (Be 9), Becher mit konischem Hals-Rand (Be 6) etc. Wenige Topfformen, darunter in *Vindobona* häufiger Töpfe mit eingeschnürter Wand (To 3).

2.NO/Nordosten – vermutlich die größte Keramikproduktion ganz Pannoniens befand sich in Aquincum; hier ist wohl auch die größte PGW-Produktion der Provinz zu lokalisieren. In Aquincum gab es 18 verschiedene Werkstättenareale, in fünf dieser Werkstätten wurde gestempelte PGW hergestellt: in der sog. Kende Street (Lágymányos; gegründet zwischen 75 und 100 n. Chr., aufgelassen vor dem Beginn des 3. Jhs. n. Chr.), in der Kiscelli-Straße/Bécsi-Straße sowie in der Aranyárok-, Macellum- und Papföld-Werkstätte (Nagy 2014: 124). In NO-Pannonien gab es zudem außerhalb Aquincums weitere PGW-Produktionen u. a. in Brigetio und Gorsium. Derzeit ist es allerdings noch nicht möglich, diese Produktionen näher zu charakterisieren, da im publiziertem Material dieser Fundorte sehr viele Importe aus Aquincum vorhanden sind.

Charakteristika: in diesem Herstellungsgebiet überwiegt zwar die Stempelung der Außenwand, aber die Gefäße mit einer Bodenstempelung sind auch zahlreich vertreten. Die Stempelmotive wie auch die Gefäßformen unterscheiden sich großteils von jenen aus dem NW der Provinz. Es gibt zwar viele ähnliche Stempelmotive, die sich aber beim näheren Betrachten doch als nicht ident zeigen. Aus Aquincum sind auch einige Töpfer bekannt, die ihre Produkte mit einem Namenstempel versehen haben; der Bekannteste ist Resatus. Für die Produkte seiner Werkstätte ist der Resatus-Namenstempel in einer eckigen Kartusche sowie ein Blatt/Baum-Motiv charakteristisch, die beide in mehreren Varianten vorkommen (Nagy 2017: bes. 36–38, Abb. 34, 47–48). Außerdem gab es mehrere ursprünglichen Produktionen mit *Planta-Pedis*-Stempeln sowie andere, durch ihre Namensstempel bekannte Töpfer wie Deuso (Nagy, Beszedes 2009, Nagy 2016, Nagy 2017: 35).

15 Diese Gruppe wird oft als Teil der Süd-Gruppe, oder als Teil der Westgruppe angesehen, doch ist eine SW-Gruppe klar von den beiden genannten Gruppen abgrenzbar.

16 Für eine zusammenfassende Darstellung s. Petznek 2000: 236–244 und Adler-Wölfel 2004: 96–118. Die drei Gruppen hat D. Gabler in die Forschung eingeführt (Gabler, D. 1975 (1976), Der Einfluß der südgallischen Sigillaten auf die pannonischen Töpfereien, *Arheološki vestnik* 26, 148–157, 153 f.).

Gefäßtypen und Formen: meistens wurden verschiedene Teller, Schüsseln, Schalen und Becher hergestellt (vgl. Nagy 2017: Abb. 30–32), aber auch einige seltene Formen (Nagy 2017: Abb. 3–8). Charakteristisch sind Teller ähnlich Consp. 19–21 mit Planta-Pedis-Stempeln, halbrunde und halbkugelige Schalen und Schüsseln (Sa/Sü 2 und 5), tiefe Schüsseln mit eingeschnürter Wandung (Sü 3) und gelegentlich Schüsseln großer Dimensionen. Auffallend sind verdickte Ränder und niedrige Standringe bei allen Formen außer den Schüsseln Sü 5.

Aus Ostpannonien wurde eine beachtliche Menge an PGW-Material vorgelegt, es handelt sich fast immer um stempelverzierte Stücke. Es ist nicht bekannt, ob unter den ungestempelten Gefäßen auch Gefäßtypen vorliegen, die typologisch noch nicht erschlossen sind.

3. SW/Südwesten – dieses Gebiet umfasst ein größeres geographisches Gebiet mit mehreren anzunehmenden Produktionsorten; ein archäologischer Nachweis einer Produktion der PGW liegt aber bislang nur für *Emona* vor (Istenič, Plesničar-Gec 2001). Ob zu dieser Zeit (Ende 1./Anfang 2. Jh. n. Chr.) auch in *Siscia* PGW hergestellt wurde, ist noch ungewiss. Auch steht noch nicht fest, ob die bekannten Gefäße aus *Nevidunum/Drnovo*, *Zagreb-Stenjevec* und *Zaton-Nin* in Dalmatien¹⁷ aus emonensischer/n Werkstätte/n stammen, oder ob es im Südwesten eine weitere Werkstätte gegeben hat (*Siscia*?). Sehr ähnliche oder idente Palmblätter mit doppeltem Mittelnerve und ein bestimmter Rosettentyp auf Gefäßen aus *Emona*, Töpferofen und je einem Gefäß aus *Zagreb-Stenjevec*, *Siscia* und *Zaton-Nin* in Dalmatien weisen auf *Emona* hin (vgl. Taf. 19). Ob die Motive tatsächlich ident sind, kann aber erst eine Autopsie zeigen. In *Siscia*, *Zagreb-Stenjevec* und *Nevidunum* kommen auch andere Palmblatt- und Rosetten-Typen vor, die möglicherweise aus einer anderen Werkstätte stammen.

Eine Besonderheit dieser frühen Gruppe sind die sehr kleinen Palmblätter (ca. 1 cm hoch¹⁸) und die Art der Dekore. Die Dekore sind hier sehr tief und vermutlich mit einer in positiv geschnittener Handpunze (?) aufgedruckt. Für eine händische Ausführung mit Kerb- oder Hohleisen sind die Dekore zu gleichmäßig ausgeführt. Zudem käme aber auch die Anbringung mit Hilfe eines Rollers (Rollrädchens, Rollzylinders?) bei manchen Motiven wie Rosetten in Betracht.

Anhand der wenigen, bislang publizierten Gefäße aus *Siscia*¹⁹ lässt sich feststellen, dass hier neben Gefäßen mit Parallelen in *Emona* auch solche vorliegen, die einige originelle Motive und Kompositionen aufweisen. Zu nennen sind beispielsweise Ringe, die möglicherweise auf TS-Dekore aus Lezoux mit Ringen im Hintergrund zurückgehen (Töpfer Albucius, ca. 140–170 n. Chr.), oder lange, gerade Ketten-Girlanden. Dies spricht zugunsten einer lokaler Produktion von PGW.

4. SO/Südosten – auch dieses Gebiet umfasst ein größeres geographisches Gebiet mit mehreren Produktionszentren wie *Sirmium*, *Singidunum* und wahrscheinlich *Mursa*. Das Motiv- und Formenspektrum ist nicht vollständig erschlossen, aber es scheint, dass die jeweiligen Produktionen einen eigenständigen Stil herausgebildet haben. Dementsprechend weist die PGW aus den genannten Orten ein unterschiedliches Form- und Motivspektrum auf, das teilweise den Produkten der NW- und NO-Gruppe ähnelt, teilweise aber auch eigenständige Motive und Formen beinhaltet.

Anhand des bis jetzt publizierten Materials scheint die Werkstätte in *Mursa* die Bodeninnenstempelung und den Brandmodus B präferiert zu haben (zuletzt Leleković 2018). Dies spricht dafür, dass sie zu den frühen Produktionen der PGW in Pannonien gehörte. Auch die Formtypen, die sich an TS-Formen wie Consp. 45 orientieren, sowie die Motive, die aus der italischen TS mit Appliken übernommen wurden (z. B. das „vierfache Blatt“, s. Leleković 2018: Abb. 3.6), sprechen für eine frühe Produktion (vgl. Taf. 22.d.1²⁰).

Das PGW-Material aus *Sirmium* und Umgebung ist in sehr großen Mengen vorhanden. Aufgrund des publizierten Materials lässt sich sagen, dass in dieser Region beide Stile, die wir aus NW- und NO-Pannonien kennen, präsent sind: Es finden sich sowohl Bodeninnenstempelungen mit Palmblättern und anderen Blättern, Rosetten, Girlanden und anderen Motiven, als auch Außenwandstempelungen mit gleichen oder ähnlichen Motiven (s. Dautova-Ruševljan 1996; Brukner 1981: Taf. 48–52). Beim näheren Betrachten sind auch gewisse eigenständige oder individuelle Stileigenschaften zu beobachten, wie die Stempelverzierung der Ränder bei den Formen mit breiten Rändern (wie Te 8.5 oder Te 2.5) oder Kompositionen aus großen Blättern oder Rauten, umrahmt von großen Girlanden. Auch ein namentlich bekannter Töpfer war hier tätig – falls es sich bei den entsprechenden Stücken nicht um Importe handelt –, dessen Namen (CDESSI) in einer Kartusche angegeben und in Kombination mit einem Rund-Palmblatt mit Öse gestempelt ist (Dautova-Ruševljan 1996:

17 Für weitere PGW-Gefäße aus Dalmatien s. Ožanić Roguljić, Konestra 2017.

18 Einige Palmblätter sind eventuell 1,3 cm hoch.

19 Aus *Siscia* wurden bislang nur wenige Stücke veröffentlicht (s. etwa Bačani et al. 2012: 117 Nr. 58, 60). Im Laufe des Kolloquiums im November 2019 in Zagreb und Sisak konnten weitere unpublizierte Stücke gesichtet werden.

20 s. Makjanić 1995: Abb. 31.31.

Tab. 4.5). Diese Kombination erinnert an die Erzeugnisse des Töpfers Resatus aus Aquincum. Ähnliche Rund-Palmblätter, jedoch ohne Öse, gehören zum Motivrepertoire seiner Werkstatt (Nagy 2017: Tab. 64 K5–K7, K15). Als besondere Verzierung sind Gemmen-Motive oder aufgedruckte Gemmen zu nennen (Dautova-Ruševljan 1996: Taf. 7.6). Bei den gestempelten Formen dominieren flache Schüsseln und flache Teller, sowie Knickwandschalen und kleine Krüge.

Das Material aus Singidunum weist ähnliche stilistische Charakteristika wie jenes aus Sirmium und der Region um Sirmium auf, wobei hier die Bodeninnenstempelung nur noch selten vorkommt. Die meisten verzierten Stücke aus Singidunum liegen in Tellern mit gestempelten Rändern²¹ sowie Schüsseln und Schalen/Bechern, deren Außenwand mit einer dichten Stempelornamentik bedeckt ist, vor (Bojović 1977 Taf. 11.131–135). Zwei Handpunzen aus Singidunum tragen je zwei Motive: zwei gerundete Spitzblätter, eine Rosette und ein gepunktetes *planta-pedis*-Motiv (Bojović 1977: Taf. 11.125–126).



Abb. 9 Die vier PGW-Gruppen mit den wichtigsten Produktionszentren und dem ungefähren Radius ihres Einflusses. Hervorgehoben sind die Bernsteinstraße (rote Linie) und schiffbare Flüsse (blaue Linien) (I. Berger-Pavić).

Es ist derzeit zu früh, über die Einflussgebiete einzelner Produktionszentren zu sprechen, da Materialvorlagen und entsprechende Untersuchungen noch vervollständigt werden müssen. Es lassen sich jedoch einige Beobachtungen anführen. So scheint *Carnuntum* engere wirtschaftliche (?) Beziehungen mit dem Carnuntiner Hinterland, *Savaria* und *Salla* als mit dem näher liegenden *Vindobona* gepflegt zu haben. In *Mursa* sind eher Einflüsse aus *Aquincum* als aus *Sirmium*, das geographisch näher liegt, präsent.

Ob die PGW in Pannonien im größeren Ausmaße gehandelt wurde und wie, muss noch untersucht werden. Diesbezügliche Informationen liegen etwa für *Aquincum* und *Mursa* vor. Die einzelnen PGW-Gefäße aus *Aquincum* in *Carnuntum*-Auxiliarkastell sind vielleicht auf privatem Wege dorthin gelangt (vor ca. 160 n. Chr.). Die Keramiktransporte fanden auf den Flusswegen (*Aquincum* – *Mursa*) wie auch auf den Landwegen statt. Eine Kartierung der Funde einzelner Werkstätten oder Gruppen wäre wünschenswert.

21 Diese Verzierungsart wurde auch in *Aquincum* angewandt (vgl. Nagy 2017: 211 Abb. 11).

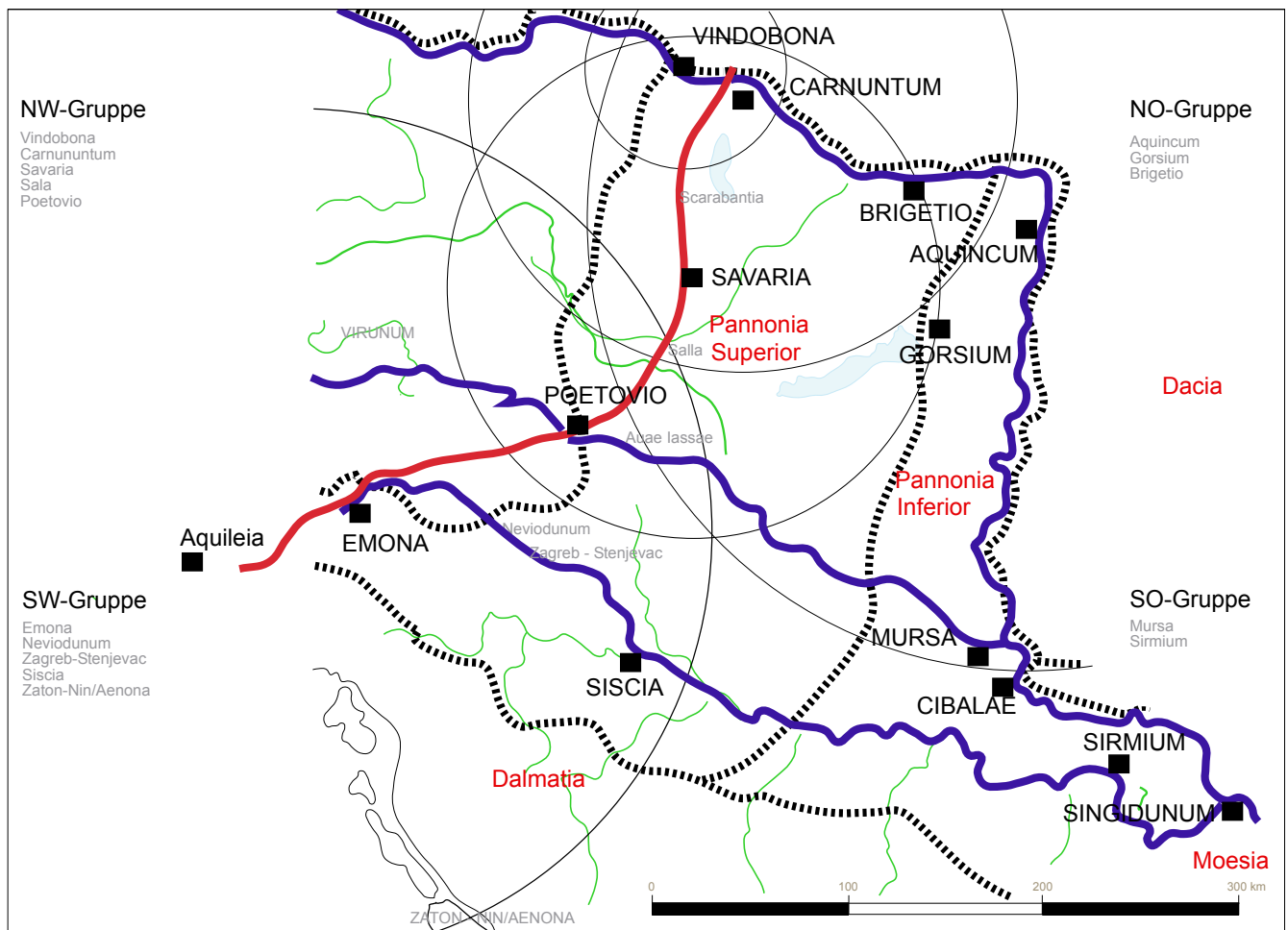
II.3 FORMVERGLEICHE (TAF. 15–18)

Neben der Erschließung des Materials einzelner Fundorte und Produktionen ist eine Publikation mit vergleichenden Untersuchungen zu Gefäßformen und Dekoren als ein Desiderat der PGW-Forschung anzusehen.

Im Folgenden sollen einige charakteristische PGW-Formen aus verschiedenen Gebieten Pannoniens verglichen werden (im nächsten Kapitel folgen einige Stempeldekore). Die festzustellenden Formentsprechungen weisen auf mögliche Beeinflussungen bei der Verbreitung sowie auf die Ausgangsorte bestimmter Formen und Dekore hin. Dabei spielen auch die Transportwege innerhalb der Provinz Pannonien und in den benachbarten Provinzen eine große Rolle.

Rundwandschüssel Sü 2.1²² (Ritterling/Hofheim 8/Consp. 36) in SW-Pannonien und in Dalmatien (Taf. 15)

Der Vergleich von Rundwandschüsseln des Typs Sü 2.1 aus SW-Pannonien (*Neviodunum*, *Poetovio* und Zagreb-Stenjevac) sowie aus *Emona* (*Regio X*) und Dalmatien (Nin-Zaton) zeigt eine große Übereinstimmung in Form und Dekor.²³ Die Schüsseln sind kugelig mit deutlich eingezogenem Randbereich, der Standing ist hoch. Die Verzierung auf der Außenwand besteht zumeist aus zwei Stempelfriesen mit dazwischenliegenden Ratterbändern. Die Stempelmotive, Rosetten und Palmblätter sind kleiner dimensioniert als jene im Nordwesten der Provinz. Nur ein Exemplar aus *Emona* zeigt leichte formale Abweichungen, ein anderes Stück aus *Poetovio* trägt kein Dekor. Für alle diese Gefäße und Produktion/en kann derselbe Zeithorizont angenommen werden, der um das Jahr 100 n. Chr. oder in den ersten Dezennien des 2. Jhs. n. Chr. liegt. Die Untersuchung zeigt, dass eine bestimmte Schüsselform mit einem bestimmten Dekor zu einem bestimmten Zeitpunkt in einem relativ großen Gebiet von *Poetovio* im Norden bis nach Dalmatien (Zaton bei Nin) Verbreitung fand. Kamen alle diese Gefäße aus einer Werkstatt und aus *Emona*? Wie oben angesprochen, ein Teil wurde bestimmt in *Emona* hergestellt, aber ein Teil kann auch aus einem anderen Produktionszentrum stammen.

Rundwandschüssel Sü 2.1 in NW-Pannonien, NO-Pannonien und SO-Pannonien (Taf. 15)

Die Schüssel Sü 2.1 kommt in NW-Pannonien in frühen Fundzusammenhängen vor und hat oft einen Bodeninnenstempeldekor (STyp 1). Die Rundwandschüssel mit verdicktem Rand (Sü 2.2) ist hier aber viel häufiger anzutreffen und gehört zu einer der meistverbreiteten Formen der PGW.

In NO-Pannonien (*Aquincum*) und im Südosten der Provinz (*Mursa*, *Singidunum*) scheint eine etwas flachere Rundwandschüssel (Sü 2) verbreiteter als die tiefe Form zu sein. Auch hier wurde diese Form gerne auf der Bodeninnenseite gestempelt.

Halbkugelige Schüsseln Sü 5 (Drag. 37) von verschiedenen Fundorten Pannoniens (Taf. 16)

Die halbkugelige Schüssel, meistens mit verdicktem Rand (Sü 5.2), ist in *Vindobona* und *Carnuntum* in zahlreichen Varianten vorhanden. Mit gerader Wandung, mit eingezogenem Rand, mit ausladendem Randbereich, mit hoher wie niedriger oberer glatter Zone. Auch die Zwischenformen Sü 1/Sü 5 sind belegt. Verschiedene Varianten sind aus ganz Pannonien bekannt. Wie das Vorbild Drag. 37 trägt sie immer ein Dekor, sei es Ratterdekor, sei es Stempeldekor. Eine nähere Untersuchung einzelner Formvarianten und Dekore und ihre zeitliche Stellung (eventuell mit Hilfe der TS-Vorbilder) wäre wünschenswert. Diese Form hält sich relativ lange, bis um die Mitte des 3. Jhs. n. Chr. Eine Schüssel Sü 5 aus *Emona* (Plesničar-Gec 1972: Taf. 39.6) weist dasselbe Stempelmotiv-Konzept auf, das sich auch auf den Schüsseln Sü 2 präsentiert. Dies lässt darauf schließen, dass beide Formen zumindest zeitweise parallel hergestellt wurden. Die Schüssel Sü 5 liegt in beiden Modi, A und B, vor.

Schrägwandschalen- und schüsseln – Sa/Sü 1 und Varianten (Taf. 17)

Die Schrägwandschalen- und schüsseln gehören in NW-Pannonien zu den meist verbreiteten Formen. Besonders häufig sind sie in *Vindobona* (Michaelerplatz) vertreten, wo sie in vier verschiedenen Ausformungen vorkommen (Pavić 2004, 120–124, Taf. 2, Taf. 9). In *Carnuntum*-Zivilstadt ist ihr Anteil niedrig, im Auxiliarkastell dagegen relativ hoch (Adler-Wölfl 2004: 39 Abb. 4). Während sie in *Vindobona* großteils eine geschwungene Wandung und eine mit Ratterdekor verzierte Außenwand aufweisen, kommen in *Carnuntum*-Auxiliarkastell häufiger Exemplare mit gerader Wandung vor, die neben dem Ratterdekor auf der Außenwand auch mit einem Stempeldekor auf der Bodeninnenseite verziert sind (Adler-Wölfl 2004: Taf. 3.36) und in die 1. Hälfte des 2. Jhs. n. Chr. datieren. In der Formgestaltung der Schrägwandschalen sind offenkundig zwei verschiedene Konzepte präsent. Einer dritten Form, die als Knickwandschale/schüssel Sa/Sü 4 oder als

22 Ausführlicher zu dieser und anderen hier behandelten Formen s. Adler-Wölfl 2004; Pavić 2004; Berger-Pavić 2021a; 2021b; diess., im Druck.

23 Petru 1978: Taf. 53.2 (*Neviodunum*), Tomanič-Jevremov 2004: 40 Nr. 83 (*Poetovio*), Gregl 1999: Taf. 28.4, 14.3, 24.3 (Zagreb-Stenjevac), Istenič, Plesničar Gec 2001: Abb. 7.5 (*Emona*), Gregl 2009: Taf. 2.2–3 (Nin-Zaton).

Mischform 1/4 eingestuft werden könnte, gehören die Schüsseln aus Gleisdorf (Artner 1994: Taf. 43 Grab 27.3; Jeschek 2000: Taf. 137.1) und Zagreb-Stenjevac (Gregl 1999: Taf. 32 Grab 119.3) an. Darüber hinaus existiert eine weitere Formvariante von Schrägwandschüsseln/schalen mit fast senkrechter Wandung, die möglicherweise im Südosten der Provinz heimisch ist (Bojović 1977: Taf. 13.146).²⁴ Eine Herstellung von Schüsseln Sü 1 ist in *Vindobona* in den *Canabae* belegt (Kronberger 2004, 103 Taf. 1; hier Taf. 12). Weitere Ateliers in *Vindobona*, in denen die Sü/Sa 1 mit Stempelverzierung produziert wurde, sind anzunehmen (vgl. Taf. 12).

Teller, Schüsseln und Schalen mit eingeschnürter Wandung – Te/Sü/Sa 3 und Varianten (Consp. 31/Drag. 27) (Taf. 17)

Diese Form ist in der PGW nicht häufig, doch ist sie sowohl als Teller, als auch als Schale und Schüssel belegt, anscheinend mit deutlichen lokalen Präferenzen bei der Formauswahl. So wurde in *Vindobona* und in *Carnuntum*²⁵ sowie im Nordwesten Pannoniens die Tellerform präferiert. Diese Teller wurden aber nach bisherigen Erkenntnissen nicht in *Vindobona* oder *Carnuntum* hergestellt. In *Vindobona* und *Carnuntum* war zudem eine flache Schalenform verbreitet, die auch in *Vindobona* hergestellt wurde (s. Taf. 12).

In *Aquincum*²⁶ zog man die Schüsselform vor und in *Aquae lassae*²⁷ und *Mursa*²⁸ tiefe Schalen.

Nicht selten tragen diese Gefäße Stempeldekor auf der Bodeninnenseite, anscheinend immer nur ein zentral platziertes Motiv. Die Form 3 wird meistens in Modus A gebrannt, aber einige Exemplare in *Aquincum*, *Vindobona* und *Carnuntum* sowie jene im Süden, in *Aquae lassae* und *Mursa*, liegen in Modus B vor. Aus *Mursa* stammt außerdem eine PGW-Schale, hergestellt im Modus B, die der Form Consp. 45 nachgebildet wurde.

Teller mit ausschwingender Wandung und Standfläche – Te 7 (Taf. 18)

Der Teller Te 7, auch in kleineren Ausführung als Schale Sa 7 produziert, gehört zu einer der verbreitetsten und ältesten Formen der PGW²⁹. Er wurde reduzierend wie oxidierend gebrannt, doch scheint die reduzierend gebrannte Variante die ursprüngliche gewesen zu sein. Bei der oxidierend gebrannten Version ist die Wandung stets wenig ausschwingend und gelegentlich gerade verlaufend. Im allgemeinen sind viele Varianten dieser Form festzustellen. Die Unterschiede treten in Bezug auf die Standfläche (Te 7A – mit Standfläche ohne Standleiste, Te 7B – Standfläche mit Standleiste, Te 7C – Standfläche auf niedrigem Standring), auf die Wandung und den Rand auf. So ist eine große Varianz an Randausformungen (Te 7.1 – gerader Rand, Te 7.2 – verdickter Rand, Te 7.3 – ausgebogener Rand, Te 7.4 – eingebogener Rand, Te 7.5 – Horizontalrand, Te 7.6 – Horizontalrand mit Leiste) ebenso wie das Vorkommen von Rändern mit zumeist zwei Griffleisten festzuhalten. Über die Herkunft der Form wurde viel diskutiert³⁰ und es ist denkbar, dass bei der Entstehung mehrere keramische Traditionen ihren Anteil hatten. Denn die Form ist nicht nur im vorrömischen Osten präsent (Sigillata B), sie wurde auch in Italien im (späten) 3. Jh. v. Chr. innerhalb der *ceramica a vernice rossa* hergestellt (Aproso 2003: 158 f. Taf. 25.VR1.1–VR1.1.5, Chiusi - Marciabella; hier Taf. 23). In römischer Zeit war die Form in allen römischen Provinzen, im Osten wie im Westen und Süden verbreitet, wiederum innerhalb unterschiedlicher Keramikgattungen/Waren. Sie findet sich auch bei der sog. Legionsware und wurde in Modus A [als Gebrauchskeramik] im Auxiliarkastell *Carnuntum* zwischen 170 und 200 n. Chr. gebrannt (Gassner et al. 1997: 200–202 Nr. 3, 27–30). Ihre rasante (?) Verbreitung und große Anzahl ist durch ihre Verwendung im militärischen Umfeld und ihre mutmaßliche Verbreitung durch die römischen Soldaten erklärbar.

In Bezug auf die vier pannonischen Gruppen kann folgendes festgehalten werden:

In NW-Pannonien weisen die Teller 7 keine Verzierung auf (weder Stempel- noch Ratterdekore).

In *Aquincum*³¹ und NO-Pannonien kommen zwei Varianten vor: die Teller Te 7 mit eher schräger, kaum ausschwingenden Wandung und Stempelverzierung auf der Bodeninnenseite, sowie kleinere Schalen mit Standring.

In SO-Pannonien sind aus *Mursa* kleinere Exemplare bzw. Schalen Sa 7 in den Varianten A, B und C bekannt (Leleković 2016: 614 Abb. 4.1–4; 2018: Abb. 3.8, 12–14). Aus Singidunum liegen Tellerfragmente mit breiten Stempeldekoren auf der

24 Zu dieser Variante gehören eventuell zwei stempelverzierte Fragmente aus *Carnuntum* (Gassner 1993: Taf. 4.21–24).

25 Maróti 1987b: Abb. 6.7; Pavić 2004: Taf. 5.8, 6; Berger-Pavić 2021a: GW11 (*Vindobona*); Adler-Wöfl 2004: Taf. 2.27 (*Carnuntum*). Für weitere Exemplare im Nordwesten s. Adler-Wöfl 2004: 35 Anm. 87.

26 Nagy 2017: Abb. 49.

27 Vikić-Belančić 1972: Taf. 14.5.

28 Leleković 2018: Abb. 3.9–10.

29 Zur Form: Gassner et al. 1997: 213–215; Adler-Wöfl 2004: 35 f.; Pavić 2004: 137 f.; Gabler et al. 2009: 65–69.

30 vgl. Gassner et al. 1997: 213–215; zur Legionsware ebd. 230–244; Chnelli et al. 2003: 196 Abb. 4.5; Gabler et al. 2009: 65–69; Leleković 2018: Kap. 5 - Cups.

31 Aus *Aquincum* sind freilich viele weitere Formen und Varianten der Te 7 bekannt, jedoch in anderen Waren und vornehmlich oxidierend gebrannt (s. Gabler et al. 2009: Abb. 5).

Innenseite des Randes vor, für die jedoch eine Zuordnung zu den Formen Te 4 oder Te 7 nicht mit Sicherheit erfolgen kann (s. Bojović 1977: Taf. 11.133–134).

II.4 VERGLEICHE ZU STEPELMOTIVEN (TAF. 19–21)

Im Folgenden sollen einige, in ganz Pannonien verbreitete Stempelmotive wie Palmbblätter, Girlanden und Rhomben verglichen werden. Rosetten, die am häufigsten vorkommen, eignen sich wegen ihrer großen Varietät und kleinen Größe weniger für Motivvergleiche (allein in NW-Pannonien sind etwa 15 unterschiedliche Typen bekannt und aus Aquincum selbst sind an die 48 Rosettenformen dokumentiert). Es sei aber erwähnt, dass auf jenem Gefäßfragment aus Siscia (unpubl.), auf dem Palmbblätter gleichen Typs und Größe (?) wie jene aus *Emona* (*Regio X*), Töpferofen vorkommen, ein „neuer“ Rosettentyp³² belegt ist (s. dazu Taf. 19). Rosetten entsprechenden Typs finden sich auf einem Gefäß aus Zaton-Nin und auf einem Stück aus Dalmatien (s. den Beitrag von Konestra et al. in diesem Band).

Palmbblatt (Taf. 19)

Das Palmbblatt-Motiv ist in vielen Varianten und in kleineren und größeren Dimensionen vertreten. Am häufigsten ist das hohe, schlanke Blatt mit gerundetem Abschluss. Weitere Abwandlungen sind das Palmbblatt mit halblangem Stängel (*Vindobona*), mit kurzem gerundetem Stängel, mit auseinander gehendem, zweifachem Stängel („Füßchen“), mit zweifachem Mittelnerv (*Aquincum*, *Siscia*, *Emona*) und mit kantigem, unterem Abschluss (Vorkommen in SW- und SO-Pannonien sowie im SO-Norikum und in *Emona*, aber auch in *Aquincum*). Eine weitere Abwandlung des Palmbblattes stellt das Rund-Palmbblatt dar, das in der Variante mit Öse in *Sirmium* und Umgebung sehr häufig vorkommt. In *Aquincum* wurden ähnliche Rund-Palmbblätter hergestellt.

Girlanden und Lunulae ohne Sporn (Taf. 20)

Girlanden und/oder Lunulae³³ gehören zu den Motiven, die in ganz Pannonien verbreitet waren, wie in *Sirmium*, *Aquincum* (acht oder neun Varianten), *Siscia*, *Salla*, *Savaria*, *Neviodunum* und *Carnuntum*. Es konnten zwar aufgrund von Füllmotiven zwei oder drei Typen festgestellt werden, doch sind sich alle Girlanden sehr ähnlich.

Raute/Rhombus (Taf. 21)

Auch die Raute (Rhombus) gehört zu den Motiven mit einem Vorkommen in ganz Pannonien. Bemerkenswert ist die Vielfalt an Füllmotiven, sodass einige Rauten bestimmten Werkstätten zugeordnet werden können. So ist die Raute mit kleinen Halbmonden nur aus *Vindobona* (Taf. 11.XI.1)³⁴ und vielleicht *Carnuntum* (Adler Wölfl 2004: Abb. 25 M38, STyp 2, Auxiliarkastell; Grünwald 1979: Taf. 17.2, Legionslager) bekannt, und daher vermutlich von lokaler Provenienz. Die gepunkteten Rauten, die auch in einem Einzelstück aus *Carnuntum*-Auxiliarkastell belegt sind, wurden in *Aquincum* produziert (s. Abb. 4). Rauten aus dem SO der Provinz haben als Füllmotive entweder Augen oder Kreuze, jene aus *Salla* Punkte entlang der Mittellinie sowie rechtwinkelige Striche. Aus *Aquincum* sind 16 unterschiedliche Rauten verschiedener Größe bekannt, großteils mit Strichel-Füllungen, Punkten bzw. kleinen Kreisen und nadelförmigen Gebilden, aber auch mit Kreuzornamenten (Nagy 2017: Tab. 73–75).

Omega und Lunula mit Sporn bzw. Öse

Diese beide Motive sind selten. Omega kommt bis jetzt als Stempelmotiv auf der Bodeninnenseite nur in *Carnuntum* und *Vindobona* vor (Abb. 5 und Taf. 11.XVII), während Lunula mit Sporn/Öse auch in *Savaria* (Maróti 1987b: Abb. 6.2) belegt ist.

III. VORBILDER, VORLÄUFER UND MÖGLICHE EINFLÜSSE³⁵ (TAF. 22–23)

III.1 GESTEMPELTE KERAMIK UND RELIEFKERAMIK VOR UND NACH DER PANNONISCHEN GLANZTONWARE

Die Verzierung der Bodeninnenseite mit gestempelten Blättern und Rosetten geht höchstwahrscheinlich auf die hellenistische gestempelte Keramik zurück, wenn auch zur Zeit nicht klar ist, über welche Tradierungslinien der Hiatus zwischen beiden Waren zu überbrücken wäre:

Zu den hellenistischen und republikanisch/frühkaiserzeitlichen Keramiken mit Stempel-, Relief- oder Applikendekoren, deren Motive sich später auch auf der PGW finden, zählen u.a.

32 Viele Rosettenmotive aus Pannonien oder Norikum (*Emona*) sind verkleinert oder schematisch abgebildet, sodass nicht ausgeschlossen ist, dass dieser Rosettentyp doch bereits nachgewiesen wurde (etwa in *Emona*?).

33 Bei den Girlanden und Lunulae handelt es sich zwar um zwei verschiedene Motive, deren Unterscheidung aber nicht immer möglich ist. Eventuell gehören die größeren Motive zu Girlanden und kleinere zu Lunulae.

34 In *Vindobona* zweimal belegt (Pavić 2004: Abb. 5.6, Taf. 12.VII; Nagy 2017: Abb. 15.19).

35 s. dazu auch Adler-Wölfl 2004: 121 f.

- (a) die italische schwarze Glanztonware – *ceramica a vernice nera* (vor allem Campana B und A),
- (b) die hispanische Kuass-Keramik,
- (c) die pergamenische Reliefkeramik,
- (d) die italische TS mit Appliken und
- (e) die gallische TS.

Formen der PGW lassen sich größtenteils auf (d) italische TS, besonders TSTP sowie (e) Gallische TS zurückführen. Zudem sind einige vorrömische Formentsprechungen vorhanden, wie

- (f) auf dem italischen Boden in etruskisch-römischer Keramik mit rotem Überzug (*ceramica a vernice rossa*),
- (g) im ostmediterranen Raum in der Sigillata B,
- (h) in Pannonien und in den Gebieten mit keltischer Bevölkerung in fein gemagerten grauen Ware und latenoiden Keramik.

Wie einige Formentsprechungen zwischen der PGW und

- (i) der Belgischen Ware und
- (j) der Terra Nigra zustande gekommen sind, ist noch nicht klar.

ad a) *Ceramica a vernice nera* (4. Jh. v. Chr. bis ins 1. Jh. n. Chr.)

Zu den in diesem Zusammenhang interessantesten Gefäßen mit Bodeninnenstempelung gehören jene aus dem Atelier „des petites estampilles“³⁶, dessen Produktion im 3. vorchristlichen Jahrhundert anzusetzen ist. Aus diesem Atelier liegen bereits viele Stempelmotive vor, wie wir sie zu späterer Zeit auf der PGW in NW-Pannonien finden: Rosetten, Palmblätter, dreilappige Blätter (Taf. 22). Rosetten gehören zu den beliebtesten Motiven der oberadriatischen Produktionen der *ceramica a vernice nera*, innerhalb der sich auch eine Form findet, die in der PGW (wie in der TS) führend wird: der flache Teller Te 2.4/Drac. 36 (Brecciaroli Taborelli 2000: Taf. 2.2). Weitere Übereinstimmungen zwischen den Formen beider Waren sind derzeit nicht bekannt.

Campana B wurde auch in *Vindobona* (Rochusmarkt bzw. Rasumofskygasse 29–31) durch mehrere Teller-Fragmente des Typs Lamb. 7 (Morel 2272–2274, 2286) nachgewiesen, die sich nach Kristina Adler-Wölfl aufgrund ihres annähernd horizontalen Bodens in die Zeit ab dem zweiten Viertel des 1. Jh v. Chr. bis zum Anfang des 1. Jh n. Chr. datieren lassen.³⁷ Auf einem vollständig erhaltenen Teller sind vier kleine quadratische Stempelmotive aufgedruckt, jedoch keine Palmblätter oder Rosetten.

ad b) Kuass-Keramik. Ähnlich der *ceramica a vernice nera* in Italien, wurde in Hispanien die Kuass-Keramik ab Ende des 4. Jhs. v. Chr. bis um die Mitte des 2. Jhs. v. Chr. hergestellt (Niveau de Villedary y Mariñas 2003). Die Stempelmotiven, die auf der Bodeninnenseite vorkommen, bestehen ausschließlich aus Rosetten und Palmetten. Diese wurden mittels Punzen, die den römerzeitlichen Punzen, etwa jener aus *Vindobona* (hier Abb. 2), entsprechen, aufgetragen (Niveau de Villedary y Mariñas 2003: 131 Abb. 47, Punzen). Die Palmette auf einem PGW-Bodenfragment aus *Carnuntum* (Taf. 9.V) ähnelt einer Palmette auf einem Bodenfragment der Kuass-Keramik (hier Taf. 22.b), aber auch einigen Palmetten auf pergamenischer Keramik und auf italischer TS. Ähnliche Palmetten in der PGW finden sich in Pannonien auch in *Sirmium* (Dautova-Ruševljan 1996: Taf. 7.3). Die Verwendung von Palmettendekore in der Kuass-Keramik und in der PGW zeigt einerseits, dass manche Motive eine sehr lange Tradition hatten, andererseits verweist diese Langlebigkeit von Motiven auf mögliche Existenz von Motivvorlagen, die über Generationen verwendet wurden.

ad c) In Pergamon wurden Dekormotive wie Palmetten, Blätter und Knospen (?) in verschiedenen Keramiken eingesetzt, auf Relief-Glanztonkeramik (Schäfer 1968: bes. Taf. 7, 34–36; hier Taf. 22.c) ebenso wie bei der Bleiglasurkeramik mit Reliefdekor (de Luca, Abb. 2.29–35; hier Taf. 22.c).

ad d) Italische TS mit Appliken (Taf. 22d)

Eine Reihe von Form- und Dekorelementen der PGW wurde entweder direkt aus der italischen TS übernommen oder über den Umweg der gallischen TS-Reliefschüsseln. Auf die italische TS, die TS mit Appliken und TS mit Reliefdekor (Arretina) dürfen folgende Dekore oder Dekorelemente aus der PGW zurückgehen:

- Planta-Pedis-Stempel
- Namensstempel in Kartusche

- Einige Motive wie „Vierteliges Blatt“ (ähnlich in Mursa: Leleković 2018: Abb. 11.4), gepunktete Rosette und Rosette mit Blütenblättern, Palmblatt mit Fuß oder Füßchen (ähnlich in Aquincum: Nagy 2017: Taf. 63 J21 und J24), Girlande/Eierstab (häufiges Vorkommen in Pannonien, in der PGW aber stärker gekrümmt vgl. Aquincum, Nagy 2017: bes. Taf. 50 B37, 51

36 s. dazu Morel 1969, bes. Abb. 5–6.

37 Adler-Wölfl 2015: 22 f., Taf. 1.1.

B39),³⁸ gepunktete Raute (*Aquincum* und *Sirmium* – s. hier Taf. 21), drei- und fünfflappige Blätter, das Omega- bzw. Pelta-Motiv (NW-Pannonien) und vielleicht weitere Rosettentypen.³⁹

ad e) Gallische TS. Der Einfluss der gallischen TS auf die PGW ist hinreichend bekannt (Fényes 2003: bes. 144–152 Abb. 35–44; Adler-Wölfl 2004: 121; Nagy 2014: 120; 2017, 18 f.). Die bedeutendsten Formen und Elemente bzw. Dekore, die auf die gallische TS zurück gehen, sind: Sa/Te 2.4 (Drag. 36), Sa/Sü 5.2 (Drag. 37), Te 4.2 (Drag. 18/31), Sü 6 (Drag. 24, 38, 44), sowie Dekore wie der Eierstab, fünfflappige Blätter und figürliche Motive wie Hirsch, Hase usw. Dazu hat G. Fényes vergleichende Tabellen publiziert (Fényes 2003, wie oben) und A. Nagy Parallelen zwischen den einzelnen Stempelmotiven und bestimmten Werkstätten und Töpfern aufgezeigt (Nagy 2017, 18 f.).

ad f) Etruskisch-römische Keramik mit rotem Überzug (*ceramica a vernice rossa*) (Taf. 23). Dass auf dem italischen Boden die Vorbilder der Sigillata-Formen zu suchen sind, ist einleuchtend. Auch viele Formen der Gebrauchskeramik nahmen hier ihren Ausgang (etwa die pompejanisch-rote Platten). Ebenso die PGW-Teller mit ausschwingender Wandung und Standplatte (Te 7) finden innerhalb der *ceramica a vernice rossa* eine Entsprechung: Am Ende des 3. und im letzten Viertel des 2. Jhs. v. Chr. wurde dieser Tellertyp in mehreren Varianten etwa in Chiusi – Marciannella hergestellt (Aprosio 2003: 158 f. Taf. 25.VRI.1.1–VR.I.1.5).

ad g) Dass Einflüsse aus dem ostmediterranen Raum bei der Entstehung der Teller und Schalen mit ausschwingender Wandung und Standfläche (Sa/Te 7) mitgewirkt haben, wird in der Forschung allgemein akzeptiert und vertreten, wobei entsprechende Impulse über das Militär und Soldaten aus dem ostmediterranen Raum gelaufen sein könnten.⁴⁰ Auch wurde auf einige *Planta-Pedis*-Stempelformen hingewiesen, die ihre Vorbilder in den östlichen TS-Produktionen haben (Nagy 2014: 120).

ad h– i – j) La Tène/keltische Tradition, Belgische Ware und Terra Nigra (Taf. 23)

Mehrere Autoren haben bereits auf lokale, keltische Verwurzelung der PGW hingewiesen⁴¹. Die Meinungen der Autoren divergieren in diesem Punkt allerdings stark. Während einige einen deutlichen bzw. sichtbaren latènoiden Einfluss auf die Formentwicklung und Dekore erkennen, beziehen andere diesen Einfluss auf die herstellungstechnische Ebene, den reduzierenden Brand oder gewisse Tiermotive⁴². Fest steht, dass einige PGW-Formen Analogien in der vorrömischen latènoiden Keramik kennen und dass sich Formenvergleiche zur PGW innerhalb der Belgischen Ware und der Terra Nigra finden. Bei den Letztgenannten ist jedoch unklar, ob es sich hier um Entlehnungen aus diesen Waren handelt oder ob die verschiedenen, zum Teil gleichzeitig produzierten Waren auf die gleichen Vorbilder zurückgreifen.

Zu den Gefäßtypen mit ähnlichen oder entsprechenden Formen in der vorrömischen, latènoiden Keramik oder der Belgischen Ware gehören: Rundwandbecher mit eingezogenem, gewelltem Randbereich (Be 1c) mit einer Entsprechung in Belgischer Keramik (Deru 1996: 134 f. Abb. 58.5), Knickwandschalen und -schüsseln (Sa 4.3 und Sü 4.6) mit Analogien in der vorrömischen Keramik Pannoniens (für die Sa 4.3 s. Eisenmenger 2004), Töpfchen mit eingeschnürter Wandung (To 3) mit ähnlichen Töpfen in der vorrömischen Keramik und in der Belgischen Ware (Deru 1996: 114 f. P30) und rundwandige Becher/Töpfchen mit Steilrand (Be 1.5) mit Entsprechungen in der Terra Nigra Form Vindonissa 96. Ob die Glockenform Sü 1.II und die Kelche in der Belgischen Keramik (Deru Form KL) mehr verbindet als das gemeinsame Vorbild, etwa Drag. 29, muss noch untersucht werden.

Formentsprechungen in der Terra Nigra betreffen Teller (Te 7) (Taf. 7), Knickwandschüsseln (Sü 4.1–2), sowie mehrere Becherformen, nämlich die Becher mit Steilrand (Be 1.5), mit birnenförmiger Wandung (Be 2.1) und mit zylindrischem Hals (Be 6.1/2); bei dem Becher Be 6.3 handelt es sich möglicherweise um ein Terra-Nigra-Stück.

Konkret weisen beispielsweise Exemplare raetischer Terra Nigra (Walke 1965: Taf. 54.12–16, Straubing) Entsprechungen zu einigen Tellern Te 7 aus NW-Pannonien auf. Die Typen analogien der Teller Te 7 in der Belgischen Ware zeichnen sich durch einen niedrigen Standring (Variante 7b und 7c) und eine geringe Gefäßhöhe aus (s. Deru 1996: 36 f. A12.2, 48 f. A39). Jene in der ARS (Hayes 60) sind ebenfalls flach, groß dimensioniert (Platten) und mit stark ausschwingender Wandung ausgestaltet.

In Summa waren bei der Entstehung der PGW, in der Formgebung wie auch im Dekor, die italischen Einflüsse und Keramiktraditionen maßgebend. Es waren wenn nicht italische Töpfer, dann stark romanisierte Handwerker und Künstler, die mit der Herstellung von PGW in Pannonien begannen. Dennoch bleibt festzustellen, dass viele der pannonischen Töpfer einen illyrisch-keltischen oder keltischen Namen trugen, wie der bekannteste PGW-Töpfer Pannoniens *Resatus*.

38 Für die TSTP-Motive s. etwa Makjanić 1995: Abb. 31 Nr. 32b, 33, Abb. 32.

39 Nach: <https://www1.rgzm.de/samian/home/frames.htm> : Raute Nr. 54, Blätter Nr. 44–45, Rosette Nr. 9, (20.8.2020).

40 Zuletzt Nagy 2017: 10 mit dem Hinweis auf die Form Hayes 1985 Nr. 75. s. auch oben Form Te 7 (Taf. 18).

41 u.a. Gassner 1993: 359.

42 Nagy 2017: 7–10.

III.2. GESTEMPELTE GLANZTONKERAMIK AUSSERHALB VON PANNONIEN UND IN DER SPÄTANTIKE⁴³

Glanztonwaren mit Stempelverzierung außerhalb Pannonien finden sich in:

a) Moesien – Hier wurde in mehreren Produktionszentren gestempelte Glanztonware ebenso wie TS hergestellt. Letztere führt in ihrem Motivschatz viele Dekore, die aus PGW bekannt sind, wie Palmblätter, T-Blätter und andere Blattmotive, Rosetten, Rauten, Girlanden, etc. (Bjelajac 1990: Taf. 72–77, Produktionszentrum in *Viminatum/Margum*).

b) Dakien – In Dakien wurde gestempelte Glanztonware an mehreren Produktionsorten und in großen Mengen hergestellt. Als spezifisch für die dakische „PGW“ ist die Art der „Stempelverzierung“ anzuführen: Motive und Dekore sehen aus wie geschnitten (vgl. Nagy 2017: Abb. 18), wie dies bei der pannonischen SW-Gruppe angetroffen wurde (diese Verzierungsart findet sich auch in weiteren Provinzen). Auch einige Gefäßformen können typisch dakisch genannt werden, denn sie wurden in Dakien en Masse hergestellt⁴⁴: Rundwandschüsseln mit ausgebogenem Rand (Sü 2.3) und mit Steilrand (Sü 2.9; s. Gudea, Filip 1997: u.a. Abb. 1–4), sowie Knickwandteller mit ausgebogenem Rand oder Horizontalrand mit Leiste (Te 4.3 und Te 4.6; s. Gudea, Filip 1997: u.a. Abb. 5. Form 1.3.18).

c) Großbritannien – Hier finden sich gestempelte Gefäße sowohl in der Oxfordshire-Ware als auch seltener in der New Forest-Ware⁴⁵; weiters zu erwähnen ist die London-Ware, bei der Motive eingeritzt wurden. Eine echte Glanztonware mit Stempeldekor ist die Parisian-Ware (Elsdon 1982). Bei dieser Keramik handelt es sich um eine graue bis schwarze Glanztonware, die einen eigenen Stil aufweist. Dennoch kommen dieselben Dekormotive wie aus der PGW bekannt zum Einsatz: Rosetten, Palmblätter, Girlanden, Rauten, Kreuze. Die Formen lehnen sich an die TS sowie an die Belgische Ware an. Die Keramik wurde vom Ende des 1. bis ins 3. Jh. n. Chr. hergestellt und war in Lincolnshire, Humberside, in Teilen von Nottinghamshire und South Yorkshire verbreitet.

d) Italien - In Padua/Patavium, Via Montona (Cipriano et al. 2006), wurden Schrägwandschalen und Rundwandschalen mit Stempeldekoren ähnlich der PGW, datiert 100/150 n. Chr., hergestellt. Die Keramik wurde als TS-Imitation bezeichnet.

Als die gestempelte Keramik in Pannonien zum Erliegen kommt, wird die Stempeltechnik in anderen Teilen der Römischen Welt weiter angewandt und es entstehen neue Waren mit entsprechenden Dekoren. In der Spätantike kann von einer Renaissance der gestempelten Keramik gesprochen werden. Zum Teil wurde diese Keramik auch in Modellen hergestellt. Möglicherweise wurden auch die Ritz-, Schnitt- und Kerbtechnik sowie Rollrädchen (Roller) angewandt. Viele der Motive und Ornamente, die jetzt auftreten, sind bereits aus der PGW bekannt.

a) Nordafrika – In der ARS (ca. Mitte 1.–7. Jh. n. Chr.) finden sich neben einigen Formentsprechungen auch viele Motive, die von der PGW Pannoniens bekannt sind, u. a. Palmblätter, Rosetten, Kreuze und Rauten (Hayes 1972: 230–254 Abb. 38–Abb. 47).

b) Gallien – Vom Ende des 4./Anfang des 5. bis ins 6. n. Chr. wurde in Gallien Glanztonware hergestellt, auf der sich Stempeldekore finden und die unter den Namen „*sigillées paléochrétiennes*“ oder als Derivate der *sigillées paléochrétiennes*, kurz D.P.S. oder D.P.S.⁴⁶, firmieren (Rigoir 1968; Rigoir et al. 2001). Zwei Produktionsgebiete im Süden und Südosten Galliens mit mehreren Ateliers wurden festgehalten. Stempeldekore bestehen größtenteils aus Rosetten und Palmblätter sowie Rauten, Kreisen und Girlanden bzw. Bögen. Auch figürliche Motive und Kompositionen, zusammengesetzt aus verschiedenen Motiven, kommen vor. Unter den Motiven findet sich beispielsweise das Rund-Palmblatt mit Öse (Rigoir 1968: Taf. 8.6 Marseille XXII.44), wie wir es aus Sirmium kennen (Taf. 19). Die Formen lehnen sich weniger an die TS, sondern vielmehr an die *sigillée claire* an.

c) Hispanien – Auch die späte hispanische TS, hauptsächlich in Modellen hergestellt, aber auch mittels Handpunzen verziert (Pérez Rodríguez-Aragón 2014: 163), verwendet bereits bekannte Dekore wie Rosetten, Palmblätter und andere.

IZIDA BERGER-PAVIĆ
Gallitzinstraße 77/1/6, 1160 Wien, Österreich
izida.pavic@web.de

43 Zu den spätantiken Glanztonwaren, größtenteils verschiedene Sigillaten, s. Roth-Rubi 1990. Rheinische Ware, die hier aufgelistet wird, wird zwar Glanztonware genannt, sie gehört jedoch nicht der eigentlichen Glanztonware, sondern der Feinware an.

44 Ob die Formen genuin dakisch und vorrömisch sind, muss noch untersucht werden.

45 Fulford 1975, 35.

46 „Derivate“ bezieht sich auf TS bzw. es sind Derivate der TS. „Frühchristlich“ wurde die Keramik genannt, weil die Zeitperiode die frühchristliche (Zeit) ist.

ABKÜRZUNGEN

Fundorte

- CAR AuxK – Carnuntum, Auxiliarkastell
 CAR KB – Carnuntum, Zivilstadt, Kammerbau (ex „Valetudinarium“)
 CAR LL – Carnuntum, Legionslager
 CAR PP – Carnuntum, Zivilstadt, „Parkplatzgrabung“
 CAR PH – Carnuntum, Zivilstadt, Peristylhaus/Villa Urbana
 CAR TH – Carnuntum, Zivilstadt, Thermen
 VIN AH – Vindobona, Am Hof 14
 VIN MP – Vindobona, Michaelerplatz
 VIN RW 44 – Vindobona, Rennweg 44
 VIN RW 93A – Vindobona, Rennweg 93A

Sonstige Abkürzungen

- ARS – African Red Slip
 GT – Glanzton
 Kat. – Katalog
 o.M. – ohne Maßstab
 Gr. – Gruppe
 STyp – Scherbentyp (*fabric*)
 TS – Terra Sigillata
 tw. - teilweise

Typenansprache

- Consp. – Ettliger, E., Hedinger, B., Hoffmann, B., Kenrick, Ph. M., Pucci, G., Roth-Rubi, K., Schneider, G., Schnurbein, S. von, Wells, C., Zabehlicky-Scheffenecker, S., *Conspectus formarum terrae sigillatae Italico modo confectae*, Materialien zur römisch-germanischen Keramik 10, Bonn 1990.
 Hayes – Hayes, J. W. 1972, *Late Roman pottery*, British School at Rome (London).
 Hofheim – Ritterling, E. 1912/1913, *Das frühromische Lager bei Hofheim im Taunus*. *Annalen des Vereins für Altertumskunde und Geschichtsforschung* 40.
 Lamb. – Lamboglia, N. 1952, *Per una classificazione preliminare della ceramica campana*. *Atti del I Congresso Internazionale di Studi Liguri* 1950 (Bordighera 1952) 139–206.
 Morel – Morel, J.-P. 1981, *Céramique campanienne: les formes*, BEFAR 244 (Rom).
 Nb / Niederbieber – Oelmann, F. 1914, *Die Keramik des Kastells Niederbieber*, Materialien zur römisch-germanischen Keramik 1 (Frankfurt a. M.).

LITERATUR

- Adler-Wölfl, K. 2004, *Pannonische Glanztonware aus dem Auxiliarkastell von Carnuntum. Ausgrabungen der Jahre 1977–1988*. Ergänzungshefte zu den Jahresheften des Österreichischen Archäologischen Instituts 7, Wien
- Adler-Wölfl, K. 2010, Keramik, in: Moser, M. et al., *Die römischen Kasernen im Legionslager Vindobona. Die Ausgrabungen am Judenplatz in Wien in den Jahren 1995–1998. Monografien der Stadtarchäologie Wien* 5, Wien, 267–508.
- Adler-Wölfl, Mosser 2015, Adler-Wölfl, K. Mosser, M., *Archäologie am Rochusmarkt – Die Grabungen in Wien* 3, Rasumofskygasse 29–31, *Fundort Wien* 18, 4–49.
- Aprosio, M. 2003, *La ceramica a vernice rossa*, in: Pucci G., Mascione, C. (eds.), *Manifattura ceramica etrusco-romana a Chiusi. Il complesso produttivo di Marcianella*, Bari.
- Artner, W. 1994, *Die Provinzialrömischen Gräber von Gleisdorf in der Oststeiermark. Mit einem Beitrag von Reinhold Wedenig*. *Mitteilungen der Österreichischen Gesellschaft für Ur- und Frühgeschichte* 38/39 (Graz).
- Baćani et al. 2012, Baćani, I., Škrgulja, R., Tomaš Barišić, T., *Zaštitna arheološka istraživanja Gradskeg muzeja Sisak 2000–2010*, Katalog izložbe, Sisak [Archaeological conservation research of the City Museum Sisak since 2000 until 2010].
- Bánki, Zs. 1998, *Forschungen in Gorsium in den Jahren 1990–1997*, *Alba Regia* 27, 237–309.
- Berger-Pavić, I. 2016, *Engobierte Becher und Faltenbecher mit Karniesrand (Hees 2/Stuart 2) und ihre Derivate* aus der Zivilstadt Carnuntum. Importe aus den gallischen und germanischen (?) Provinzen sowie Rätien und lokale und regionale Keramik, in: S. Biegert (ed.) *RCRF Acta* 44 (Bonn) 459–471.
- Berger-Pavić, I. 2021a, *Pannonische und andere Glanztonwaren*, in: Miller, M. et al., *Ein Wohn-, Handwerks- und Verkaufsbereich in der römischen Zivilsiedlung von Vindobona. Die Keramik der Ausgrabungen in Wien* 3, Rennweg 44. *Monografien der Stadtarchäologie Wien* 12, 49–138.
- Berger-Pavić, I. 2021b, *Pannonische Glanztonware*. In: I. Mader et al., *Am Nordostrand der römischen Zivilsiedlung von Vindobona. Teilergebnisse der Ausgrabung in Wien* 3, Rennweg 93A, *Fundort Wien* 24, 138–147.
- Bjelajac, Lj. 1990, *Terra sigillata u Gornjoj Meziji : import i radionice Viminacium-Margum*, Beograd, Arheološki institut, posebna izdanja knj. 23.
- Brecciaroli Taborelli, L. 2000, *La ceramica a vernice nera padana (IV – I secolo a.C.): Aggiornamenti, osservazioni, spunti*, in: G.P. Brogiolo, G. Olcese (Eds.), *Produzione ceramica in area padana tra il II secolo a.C. e il VII secolo d.C.: nuovi dati e prospettive di ricerca*, Convegno Internazionale (Desenzano del Garda 8-10 aprile 1999), Mantova, 11–28.
- Brukner, O. 1981, *Rimska keramika u jugoslovenskom delu provincije Donje Panonije*, *Dissertationes et Monographiae* 24 (Beograd).
- Bojović, D. 1977, *Rimska keramika Singidunuma*, Beograd.
- Chinelli et al. 2003, Chinelli, R., Donat, P., Pavić, I. 2003, *Importazioni dall'Italia ed elementi di tradizione italica nella ceramica romana rinvenuta a Vienna*

- (Austria), con particolare riferimento agli scavi urbani effettuati nel Michaelerplatz (1990/1991), in: *RCRF Akta* 38, 191-200.
- Chinelli, R. 2018a, Vindobona Common Ware production: what the excavation (Rennweg 44) of material from the civilian settlement adds to current research. With the contribution of Roman Sauer, *RCRF Acta* 45 (Bonn), 525-539.
- Chinelli, R. 2018b, Oxidierend gebrannte Gebrauchskeramik: Lokale Produktion, in: Miller, M. (ed.), *Ein Wohn-, Handwerks- und Verkaufsbereich in der römischen Zivilsiedlung von Vindobona. Die Keramik der Ausgrabungen in Wien* 3, Rennweg 44. Monografien der Stadtarchäologie Wien 11 (Wien) 337-372.
- Cipriano, S., Mazzocchin, S., Rossignoli, C. 2006, Un nuovo centro di produzione ceramica a Patavium, in: Menchelli, S., Pasquinucci M. (Eds.), *Territorio e produzioni ceramiche. Paesaggi, economia e società in età romana*. Atti Convegno Pisa 2005. Instrumenta 2 (Pisa) 245-255.
- Dautova-Rusevljan, V. 1996, Prilog proučavanju rimske keramike sa pečatnim ornamentima iz Srema (*Rad muzeja Vojvodine* 37-38, 53-75).
- De Luca, G. 2000, Überlegungen zur Bleiglasurkeramik aus Pergamon, *RCRF Akta* 36, 129-146.
- Eisenmenger, U. 2004, Wege der Formtradierung – Von Latène bis Spätantike (?), *Fundort Wien* 7, 168-187.
- Elsdon, S. M. 1982, *Parisian Ware : A Study of Stamped Wares of the Roman Period in Lincolnshire, Humberside and South Yorkshire*. VORDA Research Series 4 (Highworth).
- Fényes, G. 2003, Untersuchungen zur Keramikproduktion von Brigetio, *Acta Archaeologica Academiae Scientiarum Hungaricae* 54, 2003, 101-163.
- Fitz, J., Bánki, Zs. 1974, Forschungen in Gorsium im Jahre 1972, *Alba Regia* 13, 1972, 195-244.
- Fulford, M.G. 1975, *New Forest Roman Pottery : Manufacture and Distribution, with a Corpus of the Pottery Types*. BAR 17.
- Gabler, D. 1978, Die Keramik von Vindobona, in: Harl O. (ed), *Vindobona – Die Römer im Wiener Raum*. Ausstellungskatalog. Historisches Museum der Stadt Wien (Wien) 118-136; 215-243.
- Gabler, D., Hárshegyi, P., Lassányi, G., Vámos, P. 2009, Eastern mediterranean import and its influence on local pottery in Aquincum, *Acta Archaeologica Hungarica* 60, 51-72.
- Gassner, V. 1993, Pannonische Glanztonware mit Stempelverzierung aus Carnuntum. In: B. Lamut (ed), *Ptujski arheološki zbornik ob 100-letnici muzeja in Muzejskega društva* (Ptuj) 359-383.
- Gassner et al. 1997, Gassner, V., Jilek S., Sauer, R., Der Töpferofen von Carnuntum. In: H. Stiglitz (Hrsg.), *Das Auxiliarkastell Carnuntum 1. Forschungen 1977-1988. Sonderschriften des Österreichischen Archäologischen Instituts* 29 (Wien) 179-268.
- Gregl, Z. 1989, *Rimskodobna nekropola Zagreb-Stenjevec*, Zagreb.
- Gregl, Z. 2009, O importu panonske keramike ukrašavane pečatima u Dalmaciji, in: L. Bekić (ed) *Jurišićev Zbornik*, Zagreb, 206-212, https://icua.hr/images/stories/publikacije/Juriscev_Zbornik.pdf (28.10.2015).
- Grünewald, M. 1979, *Die Gefäßkeramik des Legionslagers Carnuntum*. Der Römische Limes in Österreich 29, Wien.
- Grünewald, M. 1983, *Die Funde aus dem Schutthügel des Legionslagers von Carnuntum (Die Baugrube Pingitzer)*. Der Römische Limes in Österreich 32, Wien.
- Gudea - Filip 1997, Gudea, N., Filip, C. Die gestempelten Gefäße von Porolissum. II. Die gestempelten Gefäße aus dem Kastell auf dem Hügel Pomet. In: N. Gudea (Hrsg.), *Römer und Barbaren an den Grenzen des römischen Dakiens. Acta Musei Porolissensis* 21, Zalău 1997, 9-219.
- Gugl, C., Sauer, R. 1998, Mittelkaiserzeitliche Feinkeramik aus den Wohnterrassen von Teurnia - St. Peter in Holz, Kärnten, *Fundberichte aus Österreich* 37, 213-244.
- Hayes J. W. 1985, Sigillate orientali, in: G. Pugliese-Carratelli (ed), *Atlante delle forme ceramiche II. Ceramica fine romana nel bacino Mediterraneo (trado ellenismo e primo impero)*. *Enciclopedia dell'arte antica classica e orientale*. Roma, 1-96.
- Istenič, J., Plesničar-Gec, Lj. 2001, A pottery kiln at Emona, *RCRF Acta* 37, 141-146.
- Istenič, J. 1999, *Poetovio, zahodna grobišča I. Grobne celote iz Deželnega muzeja Joanneuma v Gradcu/Poetovio*, Graz. Katalogi in Monografije 32 (Ljubljana).
- Jeschek, G. 2000, *Die grautonige Keramik aus dem römischen Vicus von Gleisdorf (Hrsg. T. Lorenz)*. Veröffentlichungen des Institutes für klassische Archäologie der Karl-Franzens-Universität Graz 5, Wien.
- Kat. Carnuntum 1992, Jobst, W. (ed.), *Carnuntum. Das Erbe Roms an der Donau*, Katalog. Archäologisches Museum Carnuntinum (St. Pölten).
- Kat. Carnuntum 2006, Humer, F. (ed.), *Legionsadler und Druidenstab. Vom Legionslager zur Donaumetropole*, Ausstellungskatalog. Archäologisches Museum Carnuntinum, Katalogband. Katalog des Niederösterreichischen Landesmuseums N.F. 462, St. Pölten 2006.
- Kat. Carnuntum 2017, Beutler, F., Farka, C., Gugl, C., Humer, F., Kremer, G., Pollhammer, E. (ed), *Der Adler Roms. Carnuntum und die Armee der Caesaren* (St. Pölten).
- Kocztur, É. 1974, Ausgrabungen im südlichen Stadtviertel von Gorsium (Tác-Margittelep). *Alba Regia* 13, 1972, 69-148.
- Kocztur, É. V. 1991, Kora császárkori temető Solymáron [Frühkaiserzeitliches Gräberfeld in Solymár]. *Studia Comitatensia* 21, 171-334.
- Kronberger, M. 2004, Zu römischen Töpferöfen in den südlichen canabae legionis von Vindobona: Neuer Markt und Umgebung, *Fundort Wien* 7, 82-116.
- Kuzsinszky, B. 1932, A gázgyári római fazekastelep Aquincumban [Das große römische Töpferviertel in Aquincum bei Budapest], *Budapest Régiségei* 11, 1932, 3-423.
- Leleković, T. 2016, Local imitations of imported fine tablewares from southern Pannonia, in: Biegert, S. (ed) *RCRF Acta* 44, Bonn 609-618.
- Leleković, T. 2018, How were Imitations of Samian Formed? *Internet Archaeology* 50, <https://doi.org/10.11141/ia.50.18> (3.7.2019).
- Makjanić, R. 1995, Terra Sigillata / Samian Ware found

- in Siscia (Sisak, Croatia), now at the Archaeological Museum in Zagreb, in: Košćević, R., Makjanić, R., *Siscia, Pannonia Superior. Finds and Metalwork Production*, BAR S621 (Oxford).
- Maróti, É. 1987a, Pecsételt római kerámia Zalalövőről, Gestempelte römische Keramik aus Zalalövő. Közlemények Zala megye közgyűjteményeinek kutatásai, *Zalai Gyűjtemény* 26, 21–36.
- Maróti, É. 1987b, Római kori pecsételt kerámia Nyugat-Pannoniában, Römerzeitliche gestempelte Keramik in Westpannonien, *Zalai Múz.* 1, 1987, 81–103.
- Maróti, É. 1990, Pannonische Glanztonware mit Stempelverzierung von Zalalövő, *Acta Archaeologica Hungarica* 42, 97–110.
- Mócsy, A. 1954, Korarómai sírok Szombathelyről, Frühromische Gräber in Savaria] *Archaeologiai Értésítő* 81, 167–191.
- Morel, J.-P. 1969, Etudes de céramique campanienne, I : L'atelier des petites estampilles. In: *Mélanges d'archéologie et d'histoire* 81.1, 59–117, https://www.persee.fr/doc/mefr_0223-4874_1969_num_81_1_7569 (3.7.2019).
- Nagy, A., Beszédes, J. 2009, Kora császárkori edény bennszülött fazekas nevével Lágymányosról (Budapest XI. kerület), in: Bíró, S. (ed.), *EX OFFICINA... Studia in honorem Dénes Gabler*, Győr, 389–401.
- Nagy, A. 2014, Forging Samian ware in the Pannonian way : the case of stamped pottery, *RCRF Akta* 43, Bonn, 119–127.
- Nagy, A. 2016, Vessels with planta pedis stamp in the area of Aquincum, *Communicationes Archaeologicae Hungariae* 2015–2016, Budapest, 209–234.
- Nagy, A. 2017, *Resatus and the Stamped Pottery*. Aquincum Stud. 1, Budapest.
- Nikolić-Dorđević, S. 2000, Antička keramika Singidunuma – oblici posuda. *Singidunum* 2, 11–244.
- Niveau de Villedary y Mariñas, A. M. 2003, Las cerámicas gaditanas “tipo Kuass”: bases para el análisis de la Bahía de Cádiz en época púnica. *Bibliotheca Archaeologica Hispana* 21, Madrid.
- Ožanić Roguljić, I., Konestra, A. 2017, Pannonian slipped ware in Dalmatia, in: Lipovac-Vrkljan, G., Šiljeg, B., Ožanić Roguljić, I., Konestra, A. (eds.), *Rimske keramičarske i staklarske radionice, proizvodnja i trgovina na jadranskom prostoru, zbornik III. Međunarodnog arheološkog kolokvija*, 4.–5. Studeni 2014, Crikvenica, 453–462.
- Parrer, G. 2008, Pannonische Glanztonware. In: C.-M. Behling/D. Katzjäger/I. Müller/G. Parrer/A. Rauchenwald/S. Stöckl, *Zivilstadt Carnuntum – Fundbericht Haus II. Carnuntum Jahrbuch* 2008, 217–232.
- Pavić, I. 2004, Zum Formenspektrum der pannonischen Glanztonkeramik von Wien I, Michaelerplatz – Grabungen 1990/91. *Fundort Wien* 7, 118–166.
- Plesničar-Gec, Lj. 1972, *Emonske nekropole (odkrite med leti 1635–1960)*. Katalogi in Monografije 7, Ljubljana.
- Petru, S., 1978, *Neviodunum (Drnovo pri Krškem)*, Katalogi in Monografije 15, Ljubljana.
- Pérez Rodríguez-Aragón, F. 2014, Los centros de producción de la terra sigillata hispánica tardía : antiguos y nuevos centros, hornos, estructuras asociadas., *Oppidum*, 10, 147–176.
- Petznek, B. 2000, Römerzeitliche Gebrauchskeramik aus Carnuntum. Teil 3, *Carnuntum Jahrbuch* 1999 (Wien) 193–319.
- Petznek, B. 2006, Ausgewählte Gefäßkeramik aus Haus I in der Zivilstadt Carnuntum, *Carnuntum Jahrbuch* 2006, 135–280.
- Petznek, B., Radbauer, S., 2004, Neue Ergebnisse zur Pannonischen Glanztonware aus dem späten 3. Jahrhundert n. Chr., *Archäologie Österreichs* 15.2, 45–49.
- Picon, M. 2002, Les modes de cuisson, les pâtes et les vernis de la Graufesenque: une mise au point. In: M. Genin/A. Vernhet (éd.), *Céramiques de la Graufesenque et autres productions d'époque romaine: nouvelles recherches*. Arch. Hist. Romaine 7, Montagnac, 139–163.
- Reinfuß, G. 1959, Die Keramik der Jahre 1958/1959, *Carnuntum Jahrbuch*, 74–99.
- Rigoir, J. 1968, Les sigillées paléochrétiennes grises et orangées, *Gallia* 26.1, 177–244.
- Rigoir, Y., Pelletier, J.-P., Poguët, M. 2001, Les Dérivées-Sigillées Paléochrétiennes de Saint-Pierre de Vence (Eyguières, B.-du-Rh.), *Revue archéologique de Narbonnaise* 34, 33–90.
- Roth-Rubi, K. 1990, Spätantike Glanztonkeramik im Westen des römischen Imperiums. Ein Beitrag zur Leistungsfähigkeit der Wirtschaft in der Spätantike, *Bericht der Römisch-Germanischen Kommission* 71, 905–971.
- Rouvier-Jeanlin, M. 1990, Bourbon-Lancy (Saône-et-Loire) : un atelier de figurines en terre cuite gallo-romaines (les fouilles du Breuil 1985–1986), *Documents d'archéologie française* 25, Paris.
- Sauer, R. 2021, Ergebnisse der mineralogisch-petrographischen Analysen an ausgewählten Keramikproben aus Wien 3, Rennweg 44, In: M. Miller et al., *Ein Wohn-, Handwerks- und Verkaufsbereich in der römischen Zivilsiedlung von Vindobona. Die Keramik der Ausgrabungen in Wien* 3, Rennweg 44. Monografien der Stadtarchäologie Wien 12, 351–388
- Schäfer, J. 1968, *Hellenistische Keramik aus Pergamon*, Pergamenische Forschungen 2, Berlin.
- Tomanič-Jevremov, M. 2004, *Obrtniške delavnice rimske Petovione*, Ptuj.
- Vikić-Belančić, B. 1972, Prilog istraživanju antičkog naseobinskog kompleksa u Varaždinskim Toplicama, *Vjesnik Arh. muz. Zagreb*, 3. ser. 6–7, 75–132.
- Vikić-Belančić, B. 1965, Neka obilježja ranocarske keramike u jugozapadnoj Panoniji *Starinar*, n.s. 13–14, 1962–1963, 89–112.
- Walke, N. 1965, *Das römische Donaukastell Straubing-Sorviodurum*. Limesforschungen 3, Berlin.

SAŽETAK

PANONSKA KERAMIKA S PREMAZOM (PANNONISCHE GLANZTONWARE/
PANNONIAN SLIPPED WARE) SJEVEROZAPADNE PANONIJE – KARNUNT I
VINDOBONA.
UZ VREDNOVANJE KERAMIKE UNUTAR PROVINCIJE PANONIJE TE UZ OPĆI
PRIKAZ

Ključne riječi: Panononska keramika s premazom, *Carnuntum*, *Vindobona*

PGW je stolna keramika debljih stijenki (5 -10 mm), koju karakterizira sjajni premaz i pečatni ukras, koji međutim dolazi tek na manje od 10 % svih posuda. PGW može biti redukcijski (crna, smeđa) ili oksidacijski (žuta, narančasta, crvena) pečena. Oblikom se veže uz *Terra Sigillata*, posebno galsku, pa se tako ona svijetle boje češće naziva imitacija *terre sigillate*. U nekim oblicima redukcijski pečene keramike su vjerojatno prisutni i predrimski utjecaji. U sjeverozapadnoj Panoniji je ustanovljeno preko 100 različitih oblika ovog posuđa, pri čemu se najviše proizvodilo tanjure i zdjele, a manje pehare, poklopce, lonce i posude s rešetkom te preko 100 različitih pečatnih motiva, koji dolaze pojedinačno ili u kompoziciji, a najčešći motiv je list. PGW se u Panoniji počinje proizvoditi u zadnjoj trećini 1. st. po Kristu, da bi tijekom 2. stoljeća doživjela procvat i vrhunac. Najpoznatiji i moguće najstariji proizvodni centar je Aquink (Budimpešta), u kojem se u 5 radionica proizvodila PGW. Ostali proizvodni centri su slabije istraženi, ali je proizvodnja ustanovljena i u Emoni, Poetoviju, Brigetiju, Gorsiju, Sirmiju, Mursi (?) i Savariji, dok je recimo za Vindobonu i *Carnuntum* ona indirektno zaključena, na osnovu starijih nalaza peći za keramiku, prisustva gliništa, kemijskih i geološko-petrografskih analiza, tipologije posuda te selekcije fabrikata (*Scherbentyp-a*). Proizvodnja se u nekim radionicama ili centrima nastavlja i u 1. polovici 3. stoljeća, dok je za razdoblje kasnog 3. i 4. stoljeća premalo podataka za opću sliku, ali se za *Carnuntum* pretpostavlja proizvodnja još samo mlađih varijanti zdjela i zdjelica s prstenastim obručem smještenim ispod oboda odnosno u gornjem dijelu posude (*Ringschüssel – Sü 6b*) i mlađih varijanti tanjura s ravnim dnom (Te 8). Te se posude međutim razlikuju od onih iz 2. stoljeća ne samo oblikom, nego i kvalitetom odnosno tehnikom izrade: sjajni premaz je nestao, a na njegovo mjesto je stupilo parcijalno glačanje vanjske površine posuda te ukrasi izvedeni urezima.

Autorica u članku obrađuje nekoliko tema:

U I. poglavlju se na osnovu do sada objavljenih radova daje poredbena analiza PGW-a Sjeverozapadne grupe uz akcent na materijalu iz *Carnuntuma* i *Vindobone*. Daje se opis keramike, spektar oblika posuda te pečatnih ukrasa. U posebnim potpoglavljima se obrađuju nalazi iz *Carnuntuma* i *Vindobone* s obzirom na navedene značajke, te mogući importi iz drugih dijelova Panonije.

U II. poglavlju se daje opći pregled PGW-a unutar provincije Panonije. Uz osnovne podatke o toj vrsti keramike, obrađuju se tri odnosno četiri glavne grupe, koje su i zemljopisno uvjetovane – Sjeveroistočna grupa (s glavnim produkcijskim središtem u Akvinku, Sjeverozapadna grupa (*Savaria*, *Carnuntum*, *Vindobona*), Jugozapadna grupa (*Emona* i *Poetovio*) i jugoistočna grupa (*Sirmium*). Također se na osnovu oblika i pečatnih ukrasa ukazuje na moguće puteve utjecaja iz pojedinih proizvodnih centara prema drugim centrima. Načinje se i pitanje lokalne proizvodnje unutar Jugozapadne grupe i pitanje podrijetla PGW u dijelovima jugozapadne Panonije i Dalmacije (današnje Hrvatske).

U III. i zadnjem poglavlju riječ je o mogućim utjecajima i prototipovima, koji su bilo oblikovno bilo putem ukrasa tj. načina ukrašavanja mogli imati utjecaja na postanak PGW-a, jer su mu kronološki prethodili, a i tehnika izrade je slična (razne helenističke keramike s pečatnim ukrasima, *Terra Sigillata* itd.). Uz to se kratko navode i primjeri proizvodnje Keramike sa sjajnim premazom izvan Panonije, kao i u vrijeme kasne antike.

Taf. 1

Teller	1 GERADER RAND	2 VERDICKTER RAND	3 AUSGEBOGENER RAND
2 GERUNDETE WANDUNG			
3 EINGESCHNÜRTE WANDUNG			
4 WANDUNG MIT WANDKNICK			
7 AUSSCHWINGENDE WANDUNG UND STANDFLÄCHE			
8. GERUNDETE WANDUNG UND STANDFLÄCHE	<p>A</p> <p>B</p>		
0 WANDUNG UND/ ODER BODEN NICHT ERHALTEN			



Taf. 1. Vindobona und Carnuntum. Typentafel Teller 1. M 1:4. Abbildungen/Umzeichnungen nach: Grünewald 1979; Gassner 1993; Adler-Wölfl 2004; Petznek 2000; Pavić 2004; Parrer 2008, Berger-Pavić 2021a, 2021b, " im Druck"). Das Material der Grabungen Carnuntum „Parkplatz“, Carnuntum Haus III wird derzeit durch die Verfasserin bearbeitet.

Taf. 2

Teller	4 NACH UNTEN GEBÜGELTER RAND	5 HORIZONTALRAND	6 HORIZONTALRAND UND RANDLEISTE	9 STEILRAND
2 GERUNDETE WANDUNG				
4 WANDUNG MIT WANDKNICK				
7 AUSSCHWINGENDE WANDUNG UND STANDFLÄCHE				
8 GERUNDETE WANDUNG UND STANDFLÄCHE				
0 WANDUNG UND BODEN NICHT ERHALTEN				

Taf. 2. Vindobona und Carnuntum. Typentafel Teller 2. M 1:4. Abbildungen/Umzeichnungen: wie Taf. 1.

Taf. 3

Schüsseln	1 GERADER RAND	2 VERDICKTER RAND	3 AUSGEBOGENER RAND	5 HORIZONTAL-RAND	6 HORIZONTALRAND UND RANDLEISTE
1.I SCHRÄGE WANDUNG a, b, c, d					
1.II GLOCKENFÖRMIG GESCHWUNGENE WANDUNG					
2 GERUNDETE WANDUNG					
4 WANDUNG MIT WANDKNICK					
5 HALBKUGELIGE WANDUNG					
6 WANDUNG MIT WANDLEISTE (RINGSCHÜSSEL)	<p>a) gerundete Wandung</p> <p>b) straffe Wandung</p>	 			





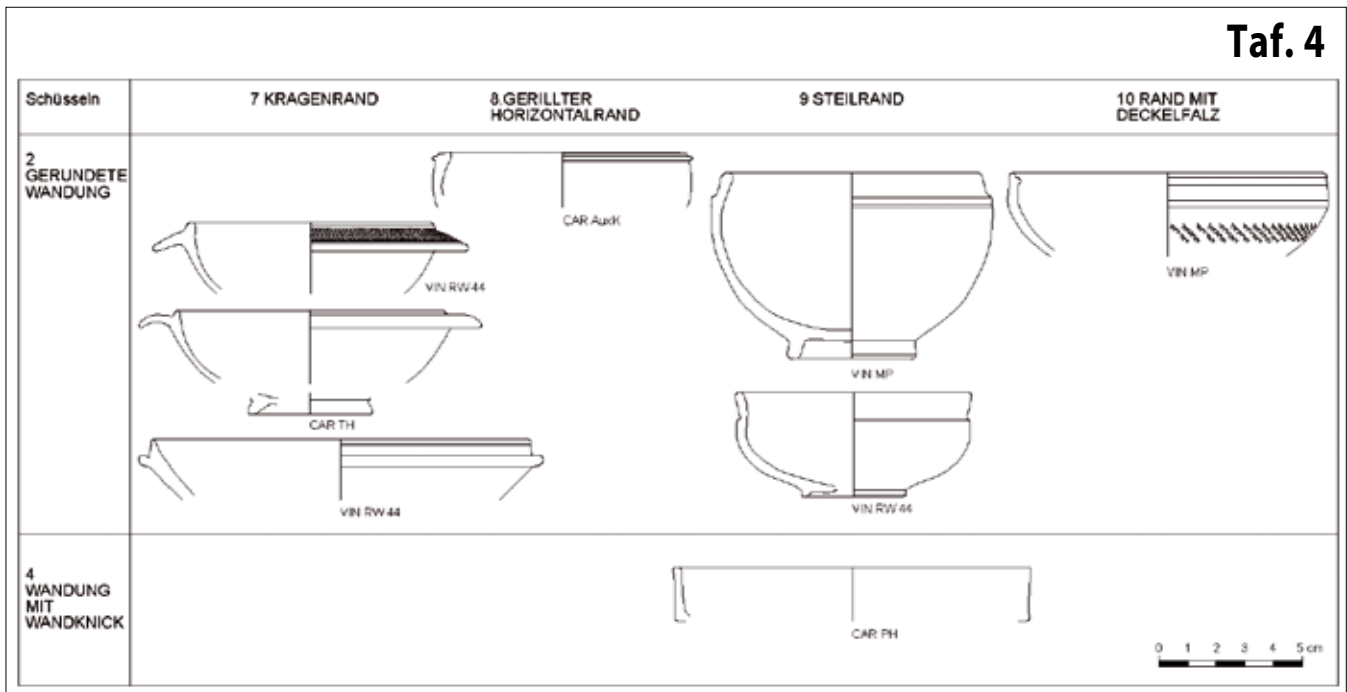

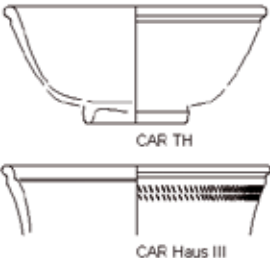

Taf. 3. Vindobona und Carnuntum. Typentafel Schüsseln 1. M 1:5. Abbildungen/Umzeichnungen: wie Taf. 1.

Taf. 4

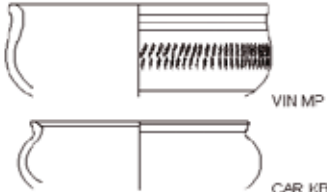



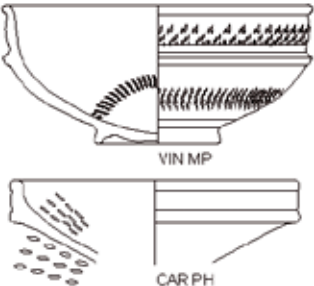
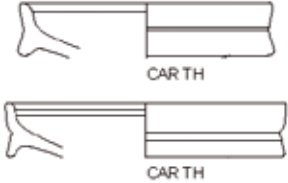







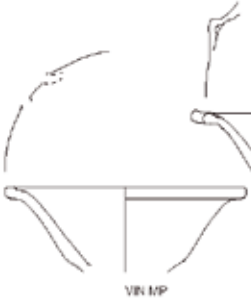
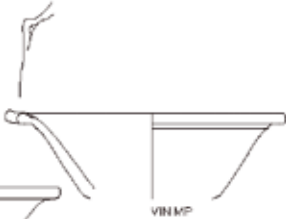



Taf. 4. Vindobona und Carnuntum. Typentafel Schüsseln 2. M 1:4. Abbildungen/Umzeichnungen: wie Taf. 1.

Taf. 5

Schalen	1 GERADER RAND	2 VERDICKTER RAND	3 AUSGEBOGENER RAND
<p>1 SCHRÄGE, WANDUNG</p>			
<p>2 GERUNDETE WANDUNG</p>			
<p>3 EINGESCHNÜRTE WANDUNG</p>			
<p>4 WANDUNG MIT WANDKNICK</p>			
<p>5 HALBKUGELIGE WANDUNG</p>			
<p>6 WANDUNG MIT WANDLEISTE (RINGSCHALEN)</p> <p>a) gerundete Wandung</p> <p>b) straffe Wandung</p>			
<p>9 WANDUNG MIT WANDKRAGEN (KRAGEN- SCHALEN)</p>			

Taf. 5. Vindobona und Carnuntum. Typentafel Schalen 1. M 1:4. Abbildungen/Umzeichnungen: wie Taf. 1.

Taf. 6

Schalen	4 NACH UNTEN GEBOGENER RAND	5 HORIZONTALRAND	6 HORIZONTALRAND UND RANDLEISTE	7 KRAGENRAND	8 STEILRAND
1 SCHRÄGE WANDUNG					
2 GERUNDETE WANDUNG	  	   	 	 	
4 WANDUNG MIT WANDKNICK					
7 AUS- SCHWINGENDE WANDUNG					



0 1 2 3 4 5 cm





Taf. 6. Vindobona und Carnuntum. Typentafel Schalen 2. M 1:4. Abbildungen/Umzeichnungen: wie Taf. 1.

Taf. 7

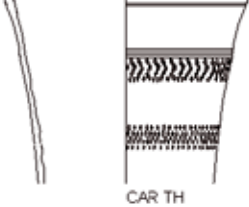
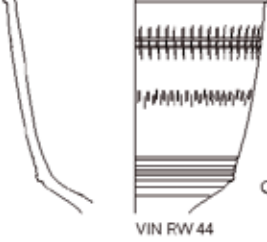
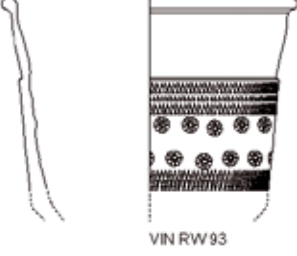
Becher Töpfe	1 GERADER RAND	2 VERDICKTER RAND	3 AUSGEBOGENER RAND	4 SCHRÄGRAND	5 STEILRAND
<p>1 BAUCHIGE WANDUNG</p> <p>a glatt</p> <p>c gewellt</p>					
<p>3 EINGESCHNÜRTE WANDUNG</p>					
<p>4 WANDUNG MIT WANDKNICK</p>					
<p>5 ZYLINDRISCHE WANDUNG</p>					
<p>6 KONISCHER HALS</p> <p>A glatt</p> <p>B gerippt</p>					

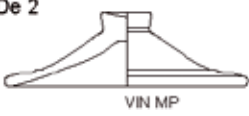
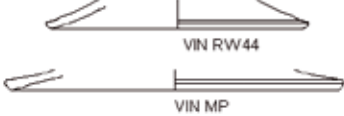
Taf. 7. Vindobona und Carnuntum. Typentafel Becher, Töpfe 1. M 1:4. Abbildungen/Umzeichnungen: wie Taf. 1.

Becher Töpfe	1 GERADER RAND	2 VERDICKTER RAND	3 AUSGEBOGENER RAND
7 ZYLINDRISCHER HALS	 CAR PP	 VIN RW44	
8 SCHRÄG NACH INNEN GEZO- GENER HALS			
9 SCHRÄGE (KONISCHE) WANDUNG	 CAR TH	 VIN RW44	 VIN RW93

Deckel		
De 1  CAR TH	De 2  VIN MP	De 3  VIN RW44 VIN MP
De 4  VIN MP	De 5  VIN MP	De 6  VIN RW44

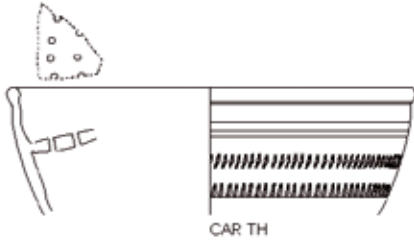
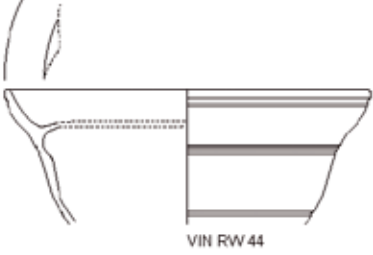
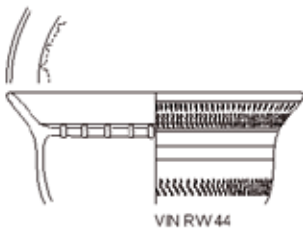
Gefäße mit gelochter Einlage ("Siebe")		
Si 1  CAR TH	Si 2.1  VIN RW44	Si 2.2  VIN RW44

0 1 2 3 4 5 cm

Taf. 8. Vindobona und Carnuntum Typentafel Becher, Töpfe 2, Deckel, „Siebe“. M 1:4. Abbildungen/Umzeichnungen: wie Taf. 1.

Taf. 9

I. Palmblatt-Motive

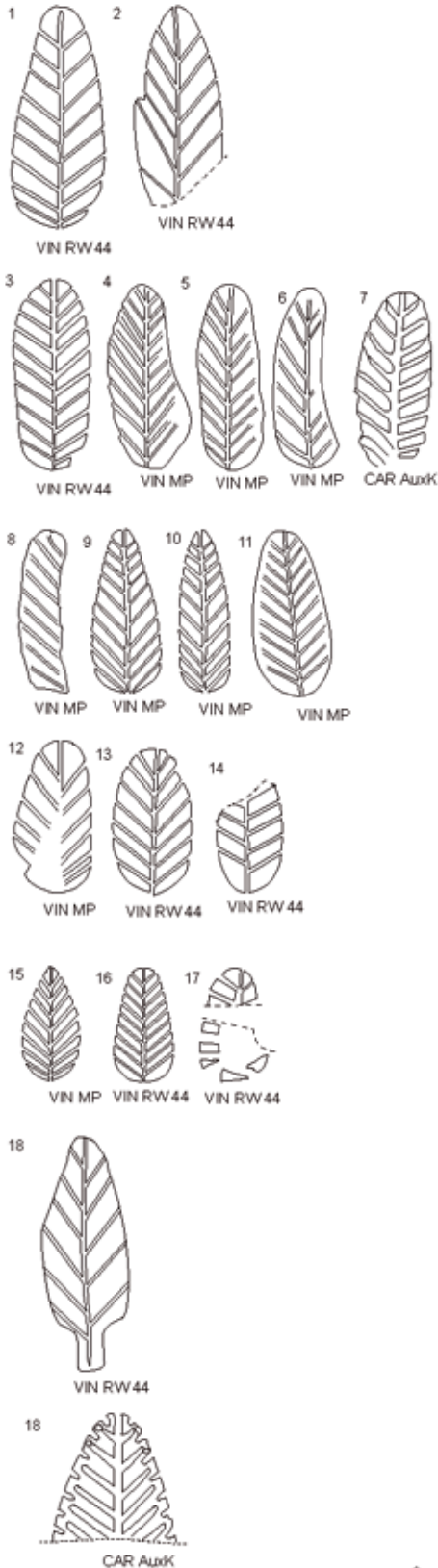

II. Rosetten

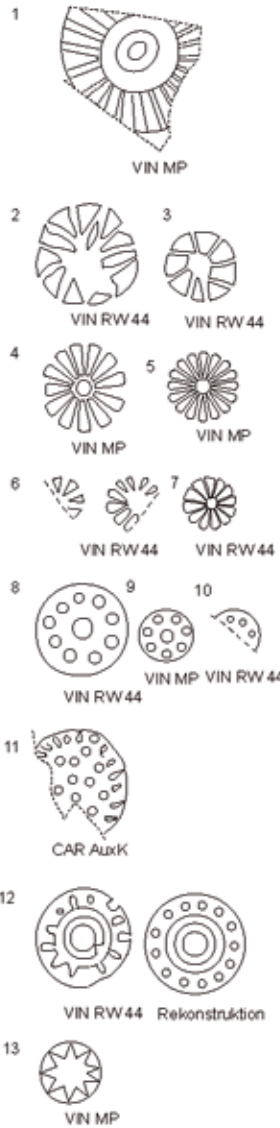

III. Eiförmige Blätter

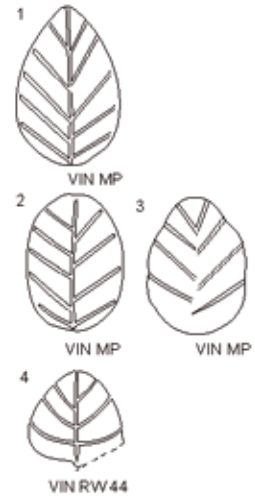

IV. Breit-eiförmige Blätter

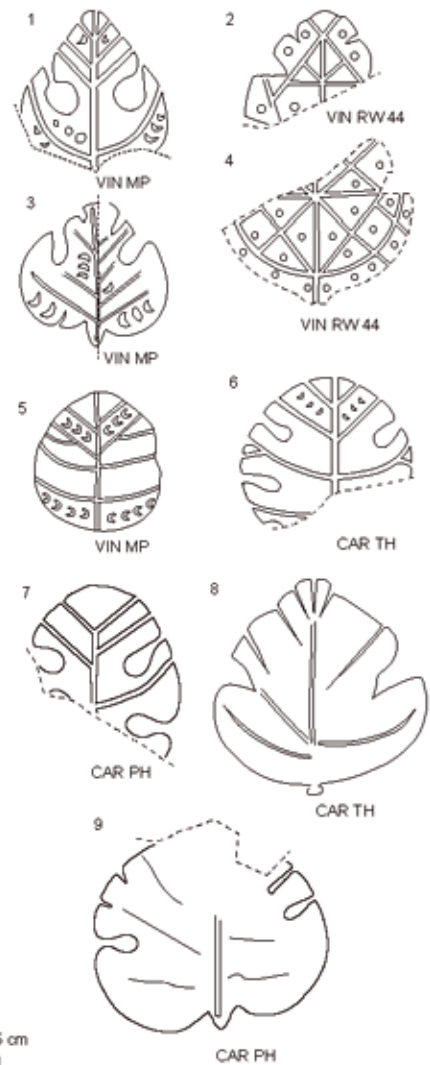

V. Palmette



Taf. 9. Vindobona und Carnuntum. Stempelmotive 1. M 1:1. Abbildungen/Umzeichnungen: wie Taf. 1.

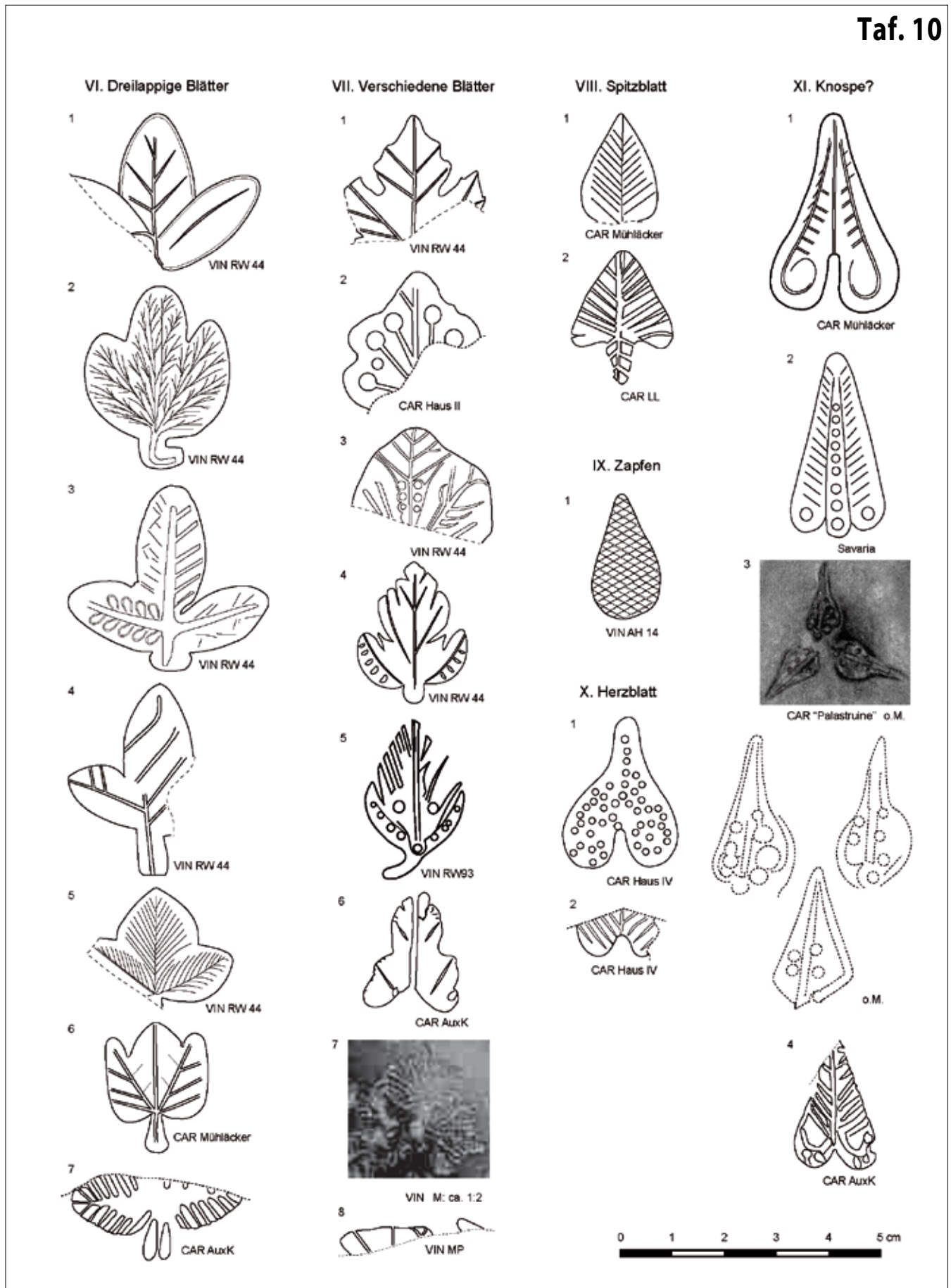

Taf. 10 Vindobona und Carnuntum. Stempelmotive 2. M 1:1. Abbildungen/Umzeichnungen: wie Taf. 1. Fotos aus: Nagy 2017: Abb. 15.16 (Nr. VII.7), Reinfuß 1959: Taf. 7.5 (Nr. X.3).

Taf. 11

XII. Doppelblatt/
Deltoid

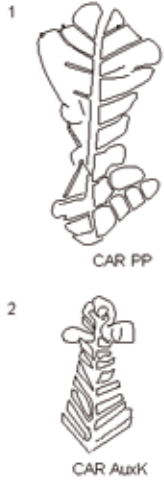

XV. Girlande

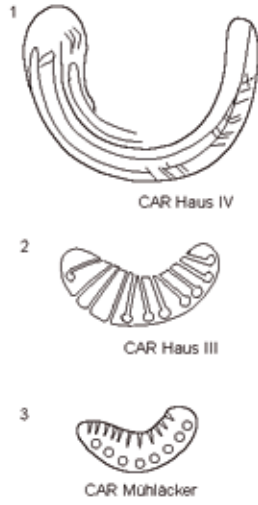

XVIII. Figürliche Motive



Weitere Motive

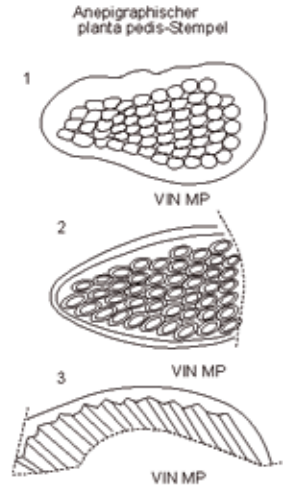

XIII. Raute/Rhombus



XIX. Namensstempel
1. - planta pedis



Federähnliches
Blatt



XVI. Lunula-Motiv



2. - Kartusche

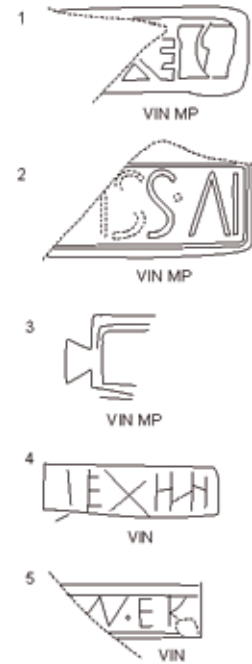

XIV. Kreuz-Motive

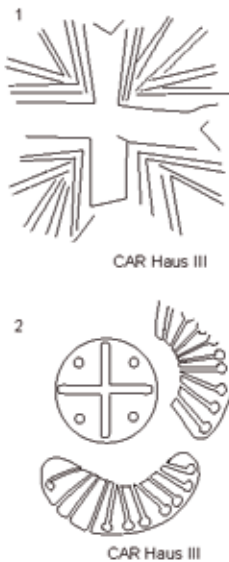

XVII. Omega-Motiv

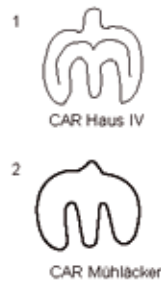

0 1 2 3 4 5 cm

Taf. 11. Vindobona und Carnuntum. Stempelmotive 3. M 1:1. s. Taf. 1. Abbildungen/Umzeichnungen: wie Taf. 1.

Vindobona, Neuer Markt (Spiegelgasse)

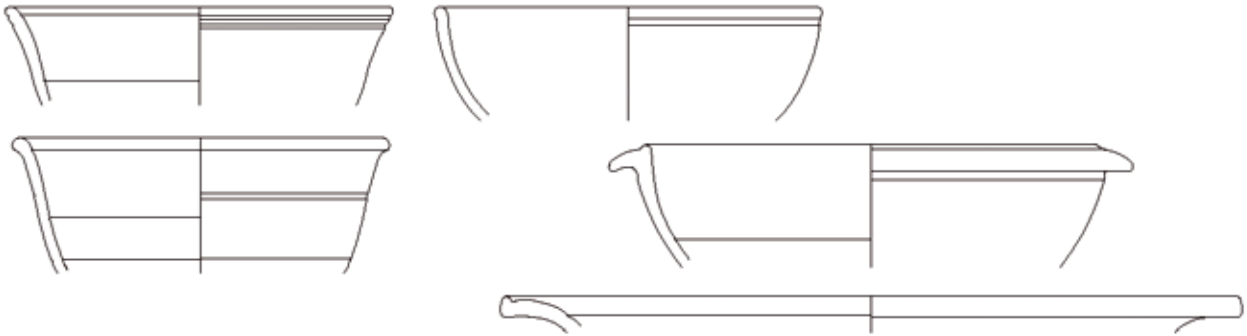

Vindobona, Rennweg 44

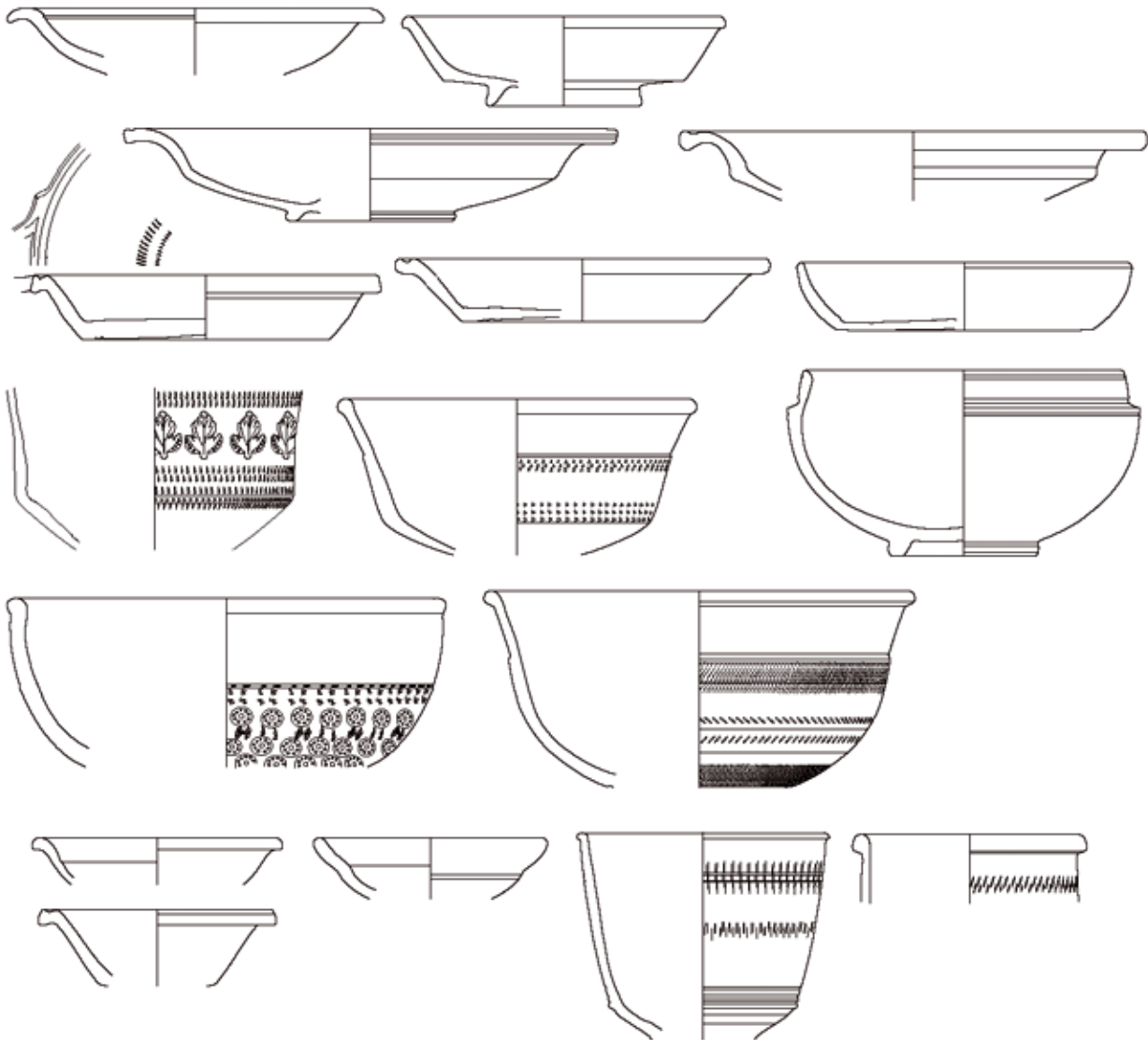

0 1 2 3 4 5 cm

Taf. 12. Vindobona. Angenommene lokale Produktion bzw. Formen. M 1:4. Abbildungen/Umzeichnungen nach: Kronberger 2004: Taf. 1–3; Berger-Pavić 2021a.

Taf. 13

STyp 2

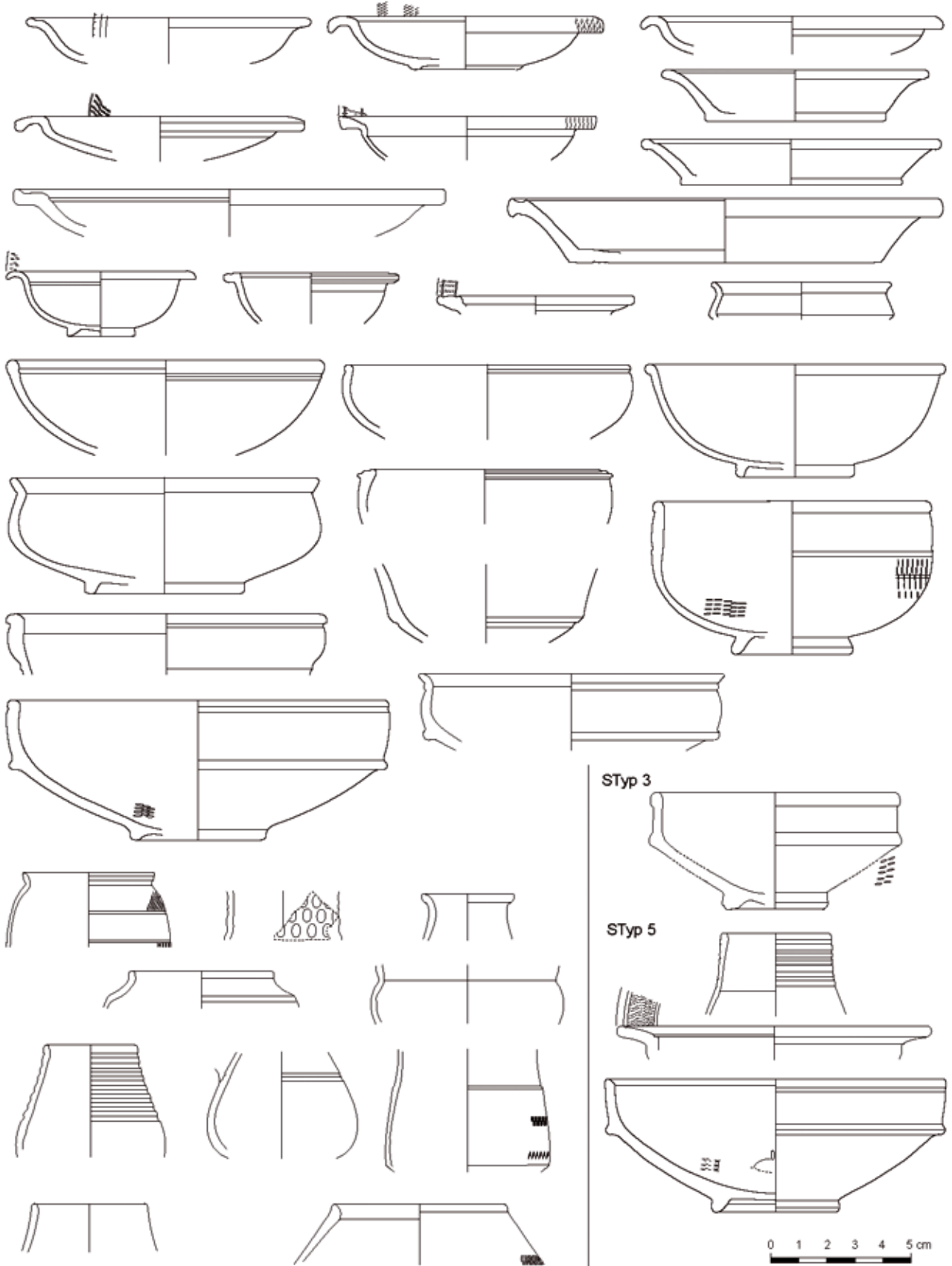

Taf. 13. Carnuntum, Auliarkastell. Lokale Produktion. M 1:4. Abbildungen/Umzeichnungen nach: Adler-Wölfel 2004.

STyp GT 3.2, 3.3

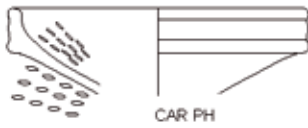

CAR PH

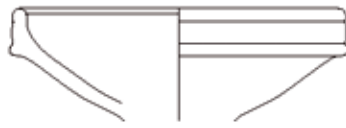

CAR PH



CAR TH



CAR PH



CAR TH



CAR TH



CAR KB

STyp GT 14



CAR TH

STyp GT 3.1



CAR TH



CAR TH



CAR TH



CAR KB



CAR TH

STyp GT 16

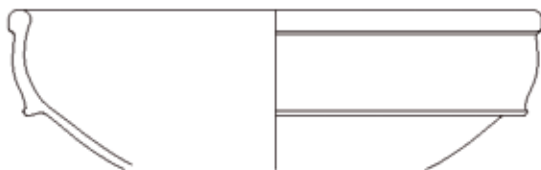

CAR TH



CAR TH

STyp GT 11

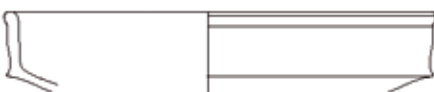

CAR TH



CAR TH



CAR TH



CAR Haus III

STyp GT 6

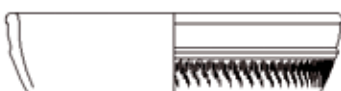

CAR Haus III

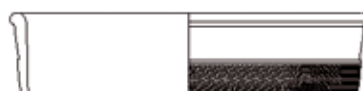

CAR Haus III



Taf. 14. Carnuntum, Zivilstadt. Angenommene lokale Produktion. M 1:4. Abbildungen/Umzeichnungen nach: Berger-Pavić, im Druck. s. auch Taf. 1.

Schüsseln Sü 2.1

Taf. 15

SW-Pannonien und Emona

Emona



Poetovio



Nevidunum



Zagreb-Stenjevec



Dalmatien

Zaton - Nin/Aenona (Iader)



NW-Pannonien
Vindobona

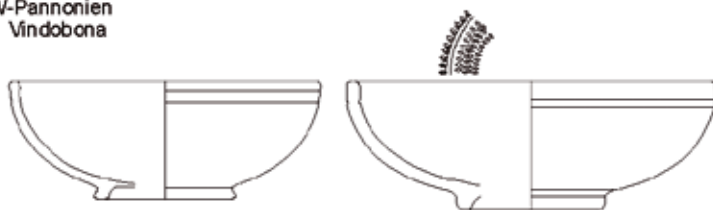

Carnuntum



NO-Pannonien
Aquincum

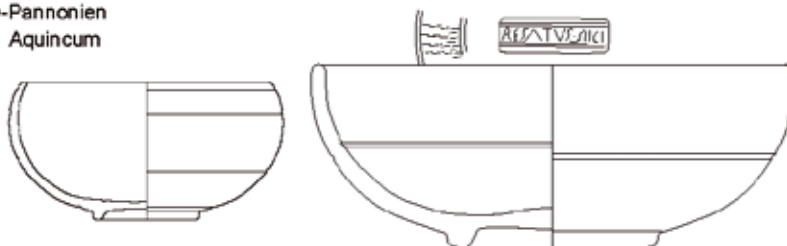

SO-Pannonien

Mursa



Taurinum (Sirmium Umgebung)



Taf. 15. Formvergleiche 1: Rundwandschalen – Sü 2.1 und 2.2 aus Pannonien mit Emona und Dalmatien. Abbildungen/Umzeichnungen nach: Istenič, Plesničar-Gec 2001: Abb. 7.5 (*Emona*), Tomanič-Jevremov 2004: 40 Nr. 83 (*Poetovio*), Petru 1978: Tab. 53.2 (*Nevidunum*), Gregl 1999: Taf. 28.4, 14.3, 24.3 (Zagreb - Stenjevec), Gregl 2009: Taf. 2.2–3 (Zaton – Nin), Nagy 2017: Abb. 30.15 (*Aquincum*), Leleković 2018: Abb. 3.16 (*Mursa*), Brukner 1981: Taf. 50.10 (*Teutoburgium*).

Schüsseln Sü 5 / Drag. 37

Vindobona

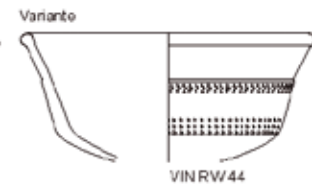
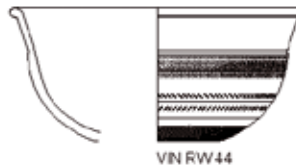
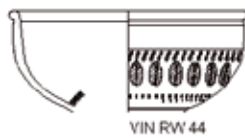
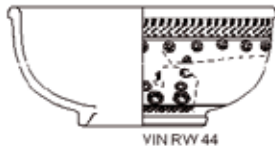
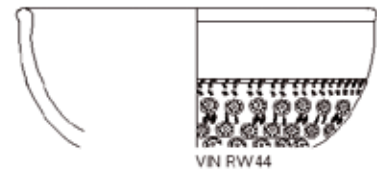
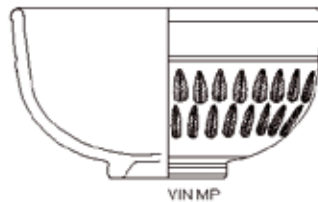
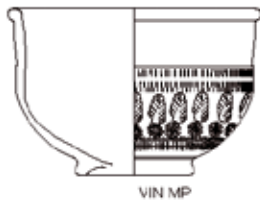

Carnuntum

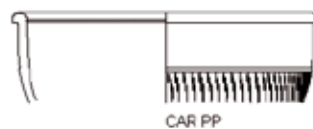
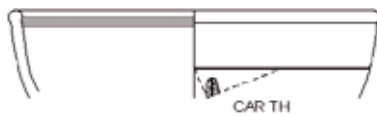
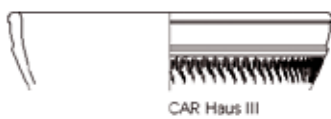

0 1 2 3 4 5 cm

Aquincum

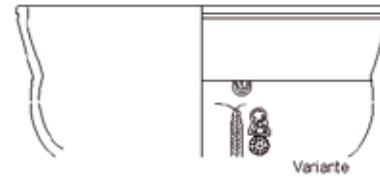
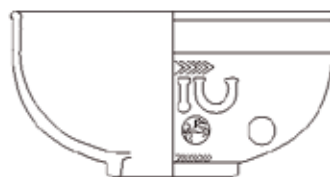
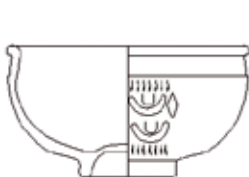

Emona

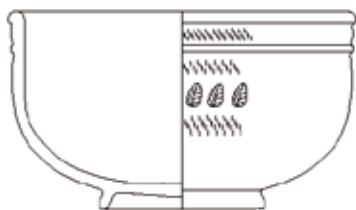

Poetovio

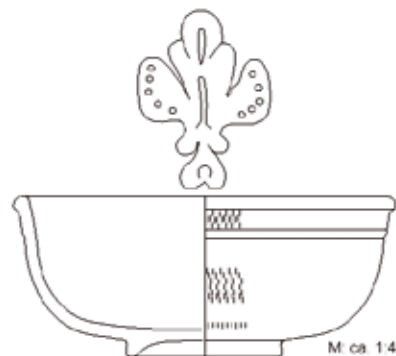

Dalmatien

Zaton - Nin/Aenona



Taf. 16. Formvergleiche 2: Halbkugelige Schüsseln – Sü 5 / Drag. 37. Abbildungen/Umzeichnungen nach: Berger-Pavic 2004, 2021a (Vindobona), Adler-Wölfl 2004: Taf. 5.112 und Berger-Pavic, im Druck (Carnuntum), Plesničar-Gec 1972: Taf. 39 Grab 141.6 (Emona), Gregl 2009: Taf. 2.1 (Zaton-Nin/Aenona) Nagy 2017: Abb. 31.17, 20 (Aquincum), Istenič 1999: Taf. 7 Grab 25.1 (Poetovio).

Taf. 17

Schrägwandschüsseln und -schalen (Glockenschalen/schüsseln) - Sa/Sü 1 und Varianten

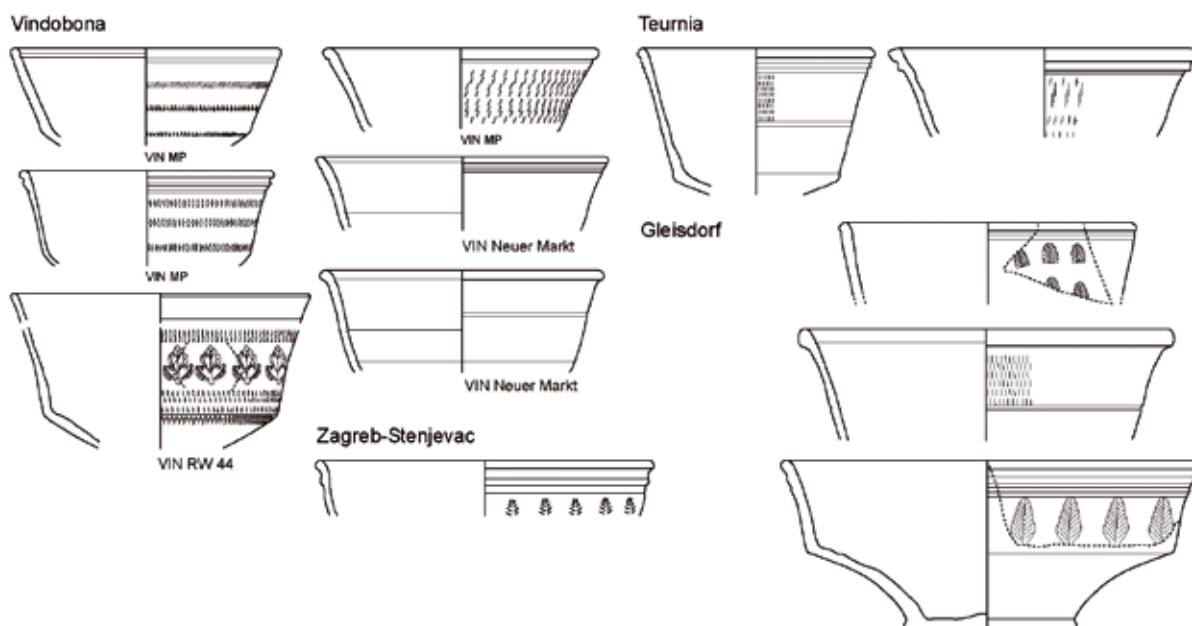

Schüsseln/Schalen mit eingeschnürter Wandung - Sü/Sa/Te 3 und Varianten

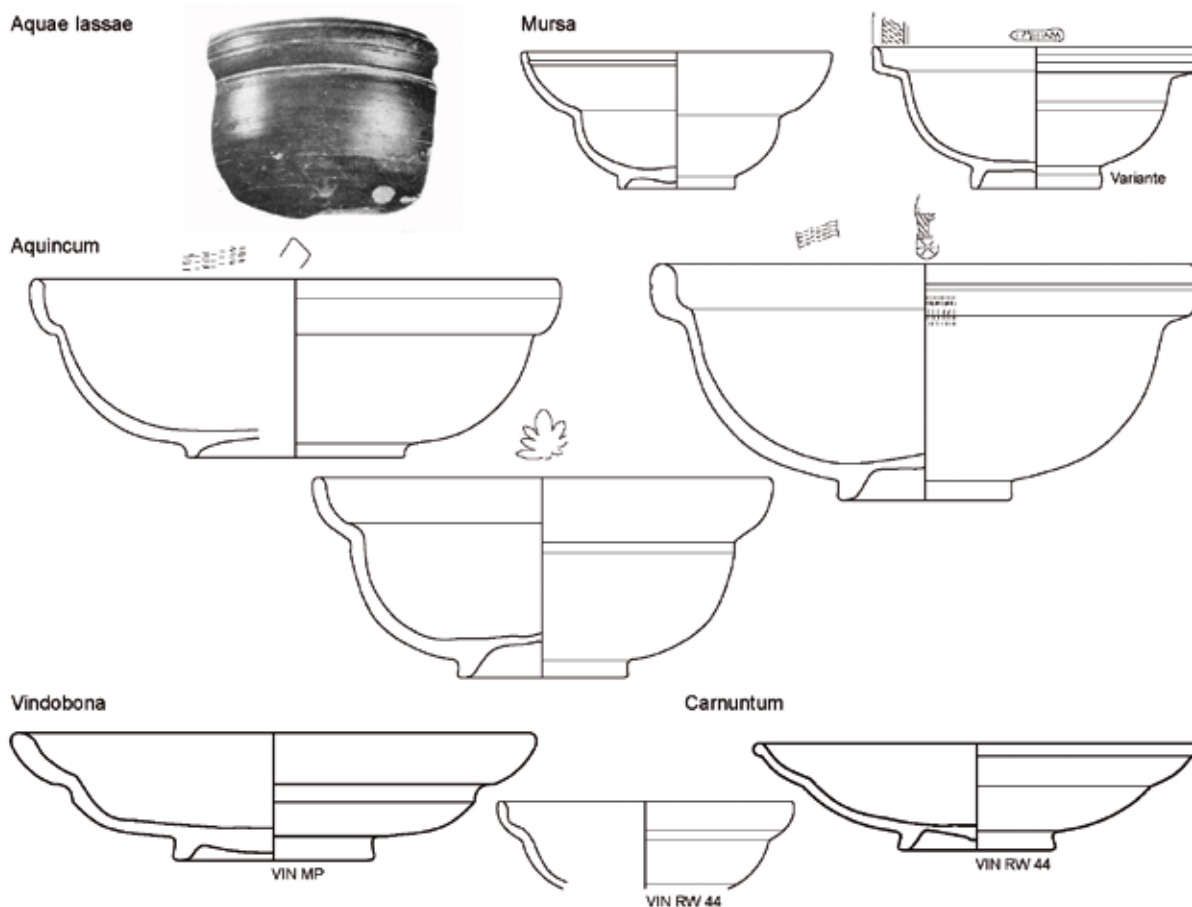

Taf. 17. Formvergleiche 3: Schrägwandschalen und Schüsseln – Sü 1 aus Pannonien und Noricum. Abbildungen/Umzeichnungen nach: Pavić 2004: Taf. 7.22; 2021a (Vindobona, Carnuntum), Gregl 1999: Taf. 32 Grab 119.3 (Zagreb Stenjevac), Jescheck 2000: Taf. 137.1, 3 (Gleisdorf), Gugl 1998: Taf. 2.76–77, 3.88 (Teurnia). Teller, Schüsseln und Schalen mit eingeschnürter Wandung – Te/Sü/Sa 3. Abbildungen/Umzeichnungen nach: Vikić-Belančić 1972: Taf. 14.5 (Aquae lassae), Leleković 2018: Abb. 3.9–10 (Mursa); Nagy 2017: Abb. 49 (Aquincum); Pavić 2004: Taf. 5.8; Berger-Pavić 2021a: GW11 (Vindobona); Adler-Wölfl 2004: Taf. 2.27 (Carnuntum).

Teller und Schalen mit ausschwingender Wandung und Standplatte - Te 7, Sa 7

Taf. 18

Vindobona, canabae

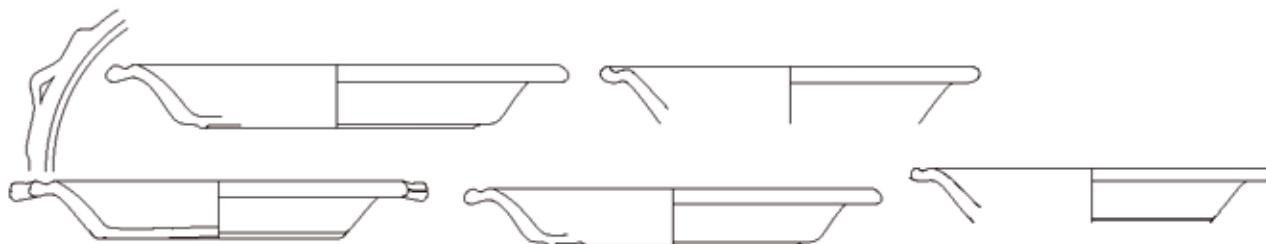

Vindobona, Zivilstadt

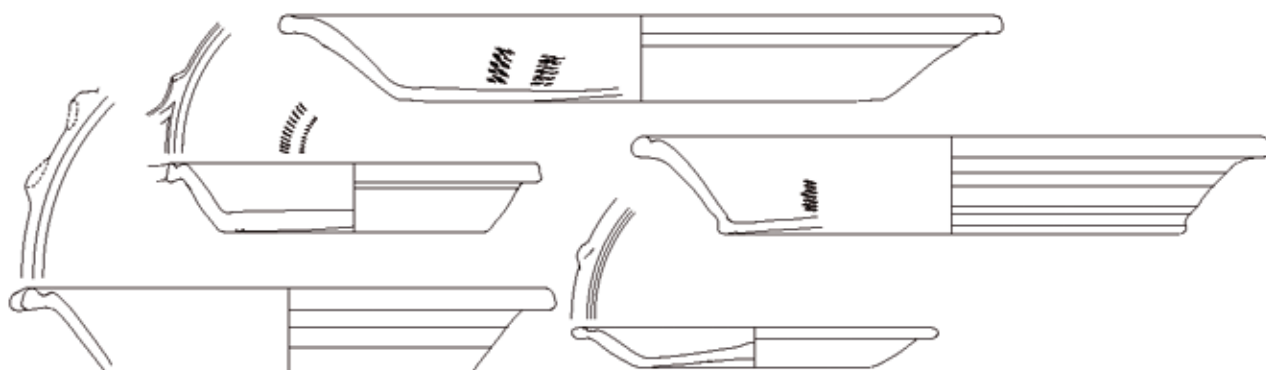

Carnuntum, Zivilstadt



Mursa

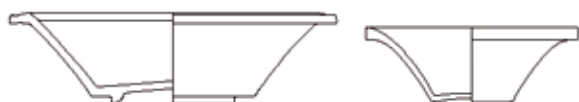

Singidunum



o.M.

Aquincum

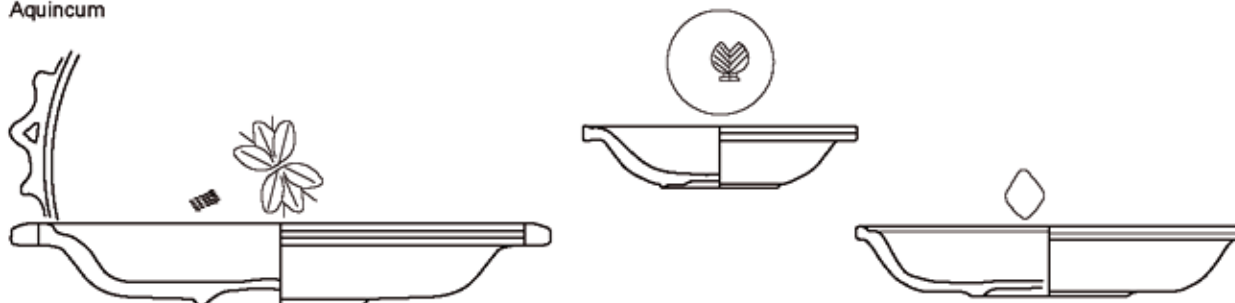

0 1 2 3 4 5 cm

Taf. 18. Formvergleiche 4: Teller mit ausschwingender Wandung und Standplatte - Te 7 sowie Schalen Sa 7. Abbildungen/Umzeichnungen nach: Pavić 2004: Taf. 7; Berger- Pavić 2021a (Vindobona), Berger- Pavić 2021b und Berger- Pavić, im Druck (Carnuntum), Leleković 2018: Abb. 3.8, 14 (Mursa), Nikolić-Đorđević 2000: 101 Tip III/14 (Singidunum), Nagy 2017: Abb. 31.11, 10, 8 (Aquincum)

Taf. 19

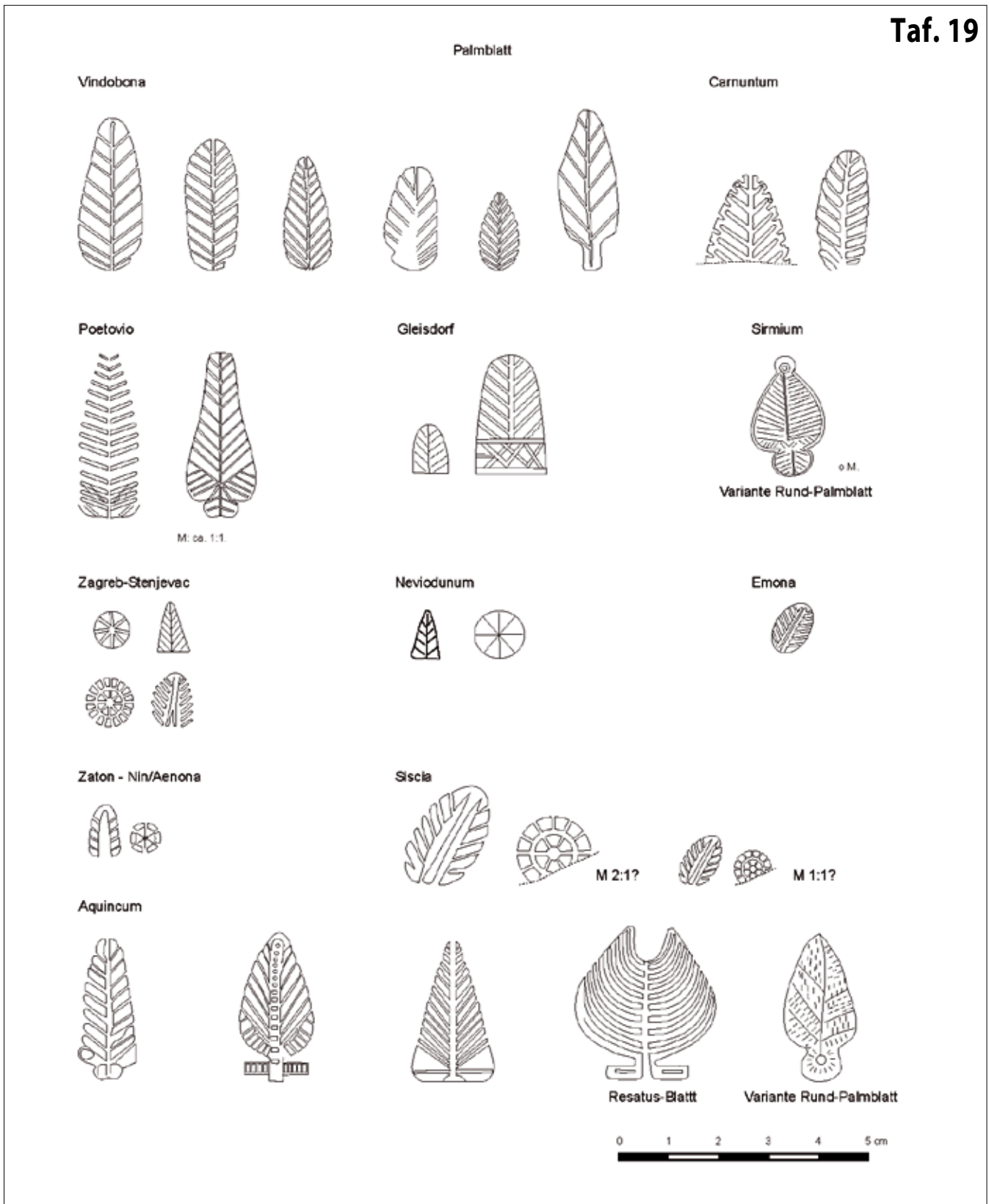

Taf. 19. Stempelmotivvergleiche 1: Palmblatt. M 1:1 (Carnuntum, Vindobona, Poetovio, Gleisdorf, Zagreb-Stenjevac, Neviodunum, Emona, Zaton - Nin, Aquincum) und o.M. (Siscia, Sirmium). Abbildungen/Umzeichnungen nach: Pavić 2004: Taf. 12.1 (Vindobona), Adler-Wölfel 2004: Abb. 25 M19, M23 (Carnuntum), Tomanič-Jevremov 2004: 19 f. Nr. 27–28 (Poetovio), Jeschek 2000: Taf. 137.3; 138.10 (Gleisdorf), Nagy 2017: Abb. 16.1, Vikić-Belančić 1965: 98 Abb. 20 (Zagreb-Stenjevac), Petru 1978: Tab. 53.2 (Neviodunum), Istenič, Plesničar-Gec 2001: Abb. 7.5 (Emona), Gregl 2009: Taf.2.2 (Zaton - Nin), Nagy 2017: Tab. 63. J21, J23, Tab. 67 N4, Tab. 68 N8, Tab. 64 K7 (Aquincum), Dautova-Ruševljan 1996: Taf. 13.6 (Sirmium). Anm. einige Motive sind schematisch und eventuell ungenau wiedergegeben (Poetovio, Neviodunum, Zagreb - Stenjevac). Sie wurden nach Abbildungen und Fotos umgezeichnet.

Girlande

Carnuntum Vindobona?



Savaria



Salla

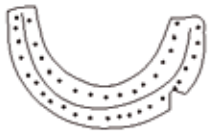

Sirmium



Aquincum



Taf. 20. Stempelmotivenvergleiche 2: Girlande. Abbildungen/Umzeichnungen nach: Gassner 1993: Taf.4.23 (*Carnuntum*), Marótti 1987B: Abb. 6.2 (*Savaria*), Marótti 1987A: Abb. 4.31–32 (*Salla*), Dautova-Ruševljan 1996: Taf. 13.30 (*Sirmium* und Umgebung), Nagy 2017: Taf. 53.B76–77, B80, B82 (*Aquincum*).

Taf. 21

Raute (Rhombus)

Vindobona, Carnuntum? Carnuntum (Import)

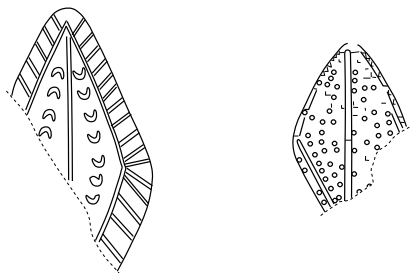

Salla

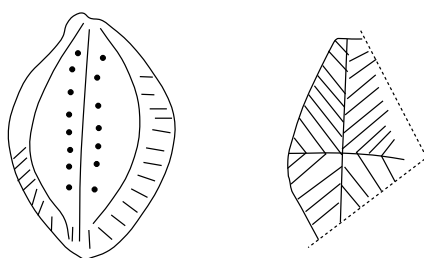

Sirmium

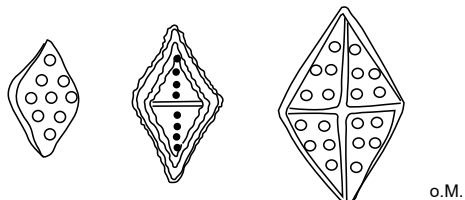

Aquincum

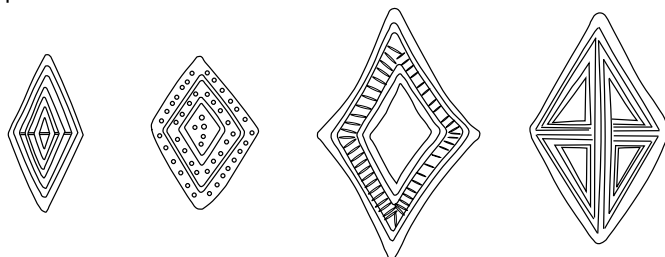

Taf. 21. Stempelmotivenvergleiche 3: Raute. Abbildungen/Umeichnungen nach: Pavić 2004 (*Vindobona*), Marótti 1987a: Abb. 4.28, 30 (*Salla*), Dautova-Ruševljan 1996: Taf. 14.4–6 (*Sirmium* und Umgebung), Nagy 2017: Taf. 73.U13, U16; 74.U19–U20; 75.U40 (*Aquincum*).

a) Keramik mit schwarzem Überzug / *ceramica a vernice nera*

Eine Auswahl an Motiven der Werkstatt "des petites estampilles"



M 1:1.

b) Kuass-Keramik



Palmette. M. ca. 1:1.

c) Reliefkeramik und Bleiglasurkeramik aus Pergamon

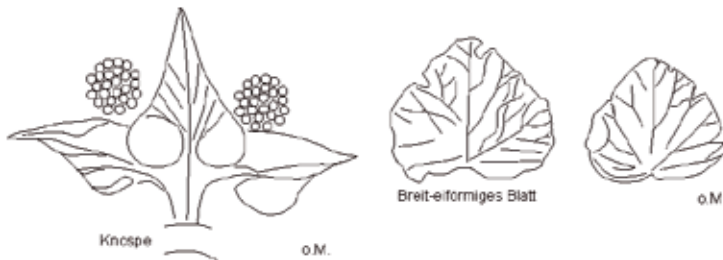

Knospe

o.M.

Breit-eiförmiges Blatt

o.M.

d) Italische Terra Sigillata

Applikenware

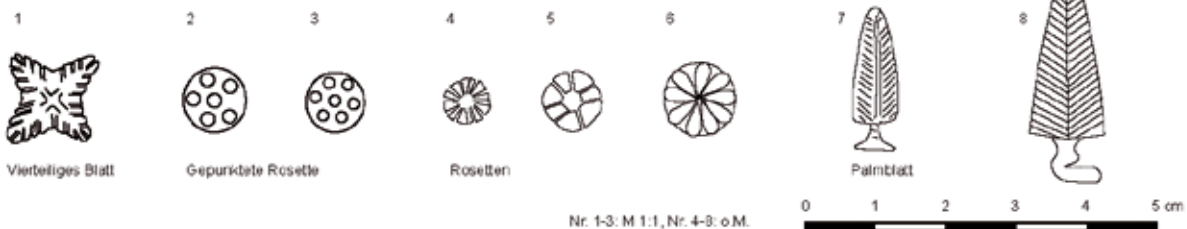

Vierteliges Blatt

Gepunktete Rosette

Rosetten

Palmblatt

Nr. 1-3: M 1:1, Nr. 4-8: o.M.



Reliefkeramik (Aretina)



Raute

o.M.

Taf. 22. Vorläufer, Vorbilder und Einflüsse 1. Hellenistische und republikanisch-frühkaiserzeitliche Reliefkeramik und Applikenware aus verschiedenen Regionen. Abbildungen/Umzeichnungen nach: Morel 1969: Abb. 6 (a - Glanztonkeramik mit schwarzem Überzug – *ceramica a vernice nera*, Motive der Werkstatt „des petites estampilles“), Niveau de Villedary y Mariñas 2003: Taf. 4 (b – Kuass-Keramik), Schäfer 1968: Taf. 34 E67 und De Luca 2000: Abb.2.30 (c – Reliefkeramik und Bleiglasurkeramik aus Pergamon), Makjanić 1995: Abb. 31 (d – italische Terra Sigillata, Applikenware).

Taf. 23

f) Etruskisch-römische Keramik mit rotem Überzug - *ceramica a vernice rossa*

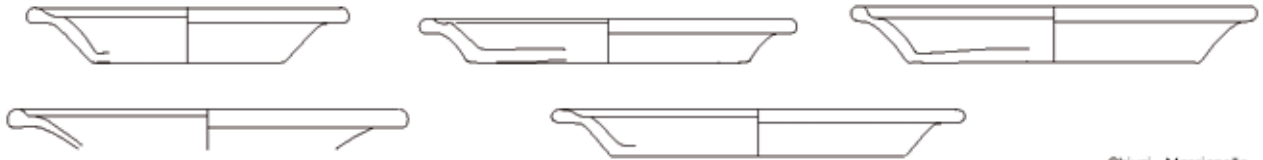

Chiusi - Marcianella

i) Belgische Ware

PGW



VIN RW44

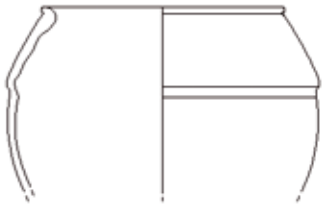

VIN RW44

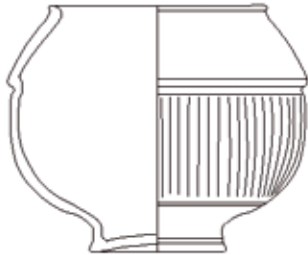

j) Terra Nigra

PGW

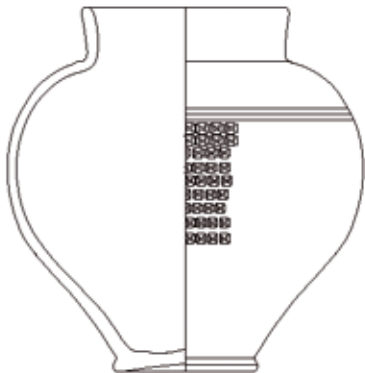

Straubing



CAR AuxK



CAR AuxK



Straubing



Taf. 23. Vorläufer, Vorbilder und Einflüsse 2. Abbildungen/Zeichnungen nach: Aprosio 2003: Taf. 25.VRI.1 – VRI.1.5 (etruskisch-römische Keramik mit rotem Überzug – *ceramica a vernice rossa*, Chiusi-Marcianella), Deru 1996: P30.1–2, Abb. 58.5 (Belgische Keramik), Walke 1965: Taf. 51.11, 54.12–15, 18 (Terra Nigra).

CELEIAN SLIP WARE. PANNONIAN SLIP WARE (PSW) FROM CELEIA: THE EVIDENCE FROM THE MARIBORSKA CESTA SITE IN CELJE, SLOVENIA

The local pottery production in municipium Claudium Celeia (modern Celje, Slovenia), the southernmost municipium in Noricum, began with the onset of the 1st century AD. This beginning has been recorded in Workshop 1 at the Mariborska cesta site, where early imitations of Italian terra sigillata were produced. Celeian Slip Ware production later moved to the potters' quarter at Breg (Workshop 5). Analysing the pottery from Mariborska cesta, we were able to identify the forms and fabrics of Celeian Slip Ware and distinguish them from the imported ones. This slip ware encompasses a wide range of products of both high (very similar to the Italian and Gallic sigillata or Raetian Ware) and low quality similar to those that emerged across the Pannonian provinces and neighbouring regions. The identified production in the 2nd and 3rd centuries AD consisted of vast numbers of large bowls, cups, plates, beakers, mortaria, fineware jars, jugs and commonware plates. Celeian Slip Ware production continued in the 4th and first half of the 5th century.

Keywords: Celje, Celeia, Noricum, Roman period, Celeian Slip Ware, pottery workshop.

INTRODUCTION

The remains of the Roman town *Celeia* stretch under the medieval town and the modern town centre of Celje (Slovenija). *Municipium Claudium Celeia* was founded in Claudian times concurrently with the establishment of *Noricum* as a senatorial province. It received a completely new urban plan, with an orthogonal street grid and a forum built *ex novo*. The town flourished on the *via publica* from Aquileia to Carnuntum (the Emona – Poetovio section) that connected Italy to the limes and traced the prehistoric Amber Route. Prior to the Roman town, the indigenous Norican population inhabited the northern slopes of Miklavški hrib – a hill on the right bank of the Savinja river. It was in the vicinity of this settlement and along the main road to Carnuntum that the first Romans erected their buildings (Bausovac, Krajšek 2020).

The investigations taking place across Celje in the last seventeen years have brought to light an enormous amount of new evidence on the town, also that for a local pottery production in Celeia that has already been researched and also briefly presented.¹ The evidence includes pottery workshops, which have been documented in several areas of the Roman town and its suburbia (Fig. 1).

1 This brief presentation on Celeian pottery production is largely the result of the research that Jure Krajšek conducted as part of his doctoral thesis (Krajšek 2015) and during subsequent work.



Fig. 1 Celje with an outline of the Roman town Celeia and with marked locations of the known pottery workshops or related sites: 1 - Mariborska cesta - Workshop 1, 2 - Levstikova ulica 1, 3 - Mariborska cesta - Workshop 2, 4 - Mariborska cesta - Workshop 3, 5 - Breg - V. Kolšek excavations, 6 - Breg - Workshop 5 (photo B. Plevčak, plan J. Krajšek).

EVIDENCE FROM THE MARIBORSKA CESTA SITE

The excavations conducted in 2003 and 2004 at Mariborska cesta² unearthed a wealth of archaeological remains. They include an ancient river bed of the Voglajna and a Celtic sanctuary on its left bank, near the river crossing, that was gradually covered by Gallo-Roman temples. After constructing the *via publica* from Aquileia to Carnuntum, and probably also a bridge over the river already at the end of the 1st cent. BC, an early Roman settlement grew on both sides of the section of the road excavated at the site. The settlement comprised pottery and metallurgic workshops, different residential buildings and wooden structures (1st and 2nd cent. AD). The site also revealed burials; the few early graves represent the northernmost burials of the northern Celeian necropolis (1st cent. AD) that continued to be used in the Late Roman period (3rd to 5th cent. AD) (Novšak et al. 2004; Gaspari, Krempuš, Novšak 2007a; 2007b).

Many sealed contexts and layers at the site offer a good basis for a typo-chronological analysis of the numerous small finds that have as yet not been fully studied. Among them are vast amounts of imported pottery including Arretine and North Italian sigillata, North Italian thin-walled pottery and Italian Cooking Ware/Pompeian Red Ware in the early layers. We identified the fabrics of *Arretina* A with the variant of the Gellius production, North Italian *Padana* B, *Padana*

² The renovation and enlargement of Mariborska cesta, now the main street towards Maribor, brought about rescue excavations carried out on some 350 m long section covering an area of over 6000 m². Excavations were conducted by the Celje office of the Institute of the Protection of Cultural Heritage of Slovenia and lead by Matjaž Novšak (Arhej d. o. o.) and Andrej Gaspari (University of Ljubljana). The desktop analyses were headed by Ana Plestenjak (Arhej d. o. o.). Jure Krajšek (now curator of Roman collections at the Celje Regional Museum) was in charge of the ceramic finds at the time, with ceramic studies also carried out by Maja Bausovac, Iris Bekljanov Zidanšek and Tina Žerjal.

C, *Tardopadana*, Aco beakers and Sarius cups. Gallic Sigillata, Raetian Ware and similar productions from the northern provinces were also common in the deposits of 2nd and 3rd cent. AD. From the middle or second half of the 1st and first quarter of the 2nd cent. AD, the quantity of imported ware from (North) Italy decreased. At the same time, certain new fabrics and forms point towards newly established regional Norican and Pannonian pottery productions. Most pottery at Mariborska cesta belonged to the local Celeian pottery (Krajšek 2015), also to Celeian Slip Ware (cfr. Krajšek, Beljanov Zidanšek, Žerjal 2019 for thin-walled pottery).

POTTERY WORKSHOP 1 AT MARIBORSKA CESTA AND THE EARLIEST LOCAL IMITATIONS OF ITALIAN *TERRA SIGILLATA*

Three pottery workshops of the local Celeian production were investigated at the Mariborska cesta site.

The largest and earliest is Workshop 1 (Fig. 1: 1), located on the right river bank near the Roman bridge. Only part of the workshop has been investigated, involving 15 to 16 kilns of a rectangular plan (Cuomo di Caprio IIb type) and one of a circular plan (Cuomo di Caprio Ib type). The numerous clay pits and kilns at the site were filled with the same material: clay, ash, ceramic dump and burnt clay with the remains of collapsed vaults or cupolae made of clay mixed with ceramic sherds. The dumped pottery shows that the potters produced tableware and fine tableware in the first half or the first three decades of the 1st cent. AD (Krajšek 2015: 99–102; Krajšek, Bekljanov Zidanšek, Žerjal 2019: 343–347).

The great numbers of sherds, faulty products, cracked and distorted examples reveal an extensive production in Workshop 1, but of a limited array of vessel forms. Some Celeian thin-walled forms imitate Italian sigillata cups. They bear no traces of a slip, although they were dumped before finishing. Conical cups (Fig. 2: 1–2) resemble *Padana* Consp. 22.6 cups from the Middle and especially the Late Augustan period (Conspectus 1990, 90). Celeian conical cups are wheel-thrown, very hard fired and mostly of an oxidised fabric (N 3.1), only one fragment was of a reduced fabric (N 3.2) and found inside the only circular kiln (Krajšek 2015, 163, Form VI.1.2.1). The next form is a derivation of the previous one, with a higher upper part with more vertical walls. The biconical cups with a lower break (Fig. 2: 3) have a reduced fabric (N 3.2) and date to the second and third quarters of the 1st cent. AD (Krajšek 2015, 164, Form VI.1.2.2; Bausovac 2014, Pl. 7: 11, Pl. 10: 8.) according to the associated archaeological contexts (Grave 59, Gallo-Roman temples at Mariborska cesta, the Osrednja knjižnica Celje site).

Other early sigillata imitations are absent among the dumped pottery, but occur in other archaeological layers of the site. The carinated cylindrical cups (Fig. 2: 4) with a small out-turned rim and made in a reduced fabric (N 3.2) resemble the *Padana* Consp. 27 sigillata cups, produced in Central and North Italy from Tiberian times to the second half of the 1st century AD (Conspectus 1990, 100; Zabehlicky-Scheffenecker 1992, 419, 423). They were also found in the necropolis at Šempeter (Kolšek 1977: Grave 18 – Pl. 11: 5, Grave 27 – Pl. 15: 31), at Gubčeva ulica in Celje (Kolšek 1972: Grave 1 – Y 149: 6) and in the habitation layers at Mariborska cesta. The burial contexts date this form to the middle and second half of the 1st century AD (Krajšek 2015: 164–165, Form VI.1.2.3).

A complete plate (Fig. 2: 8) resembling the sigillata Consp. 20.4 form, but with a low foot and a red slip was found in a habitation layer dated to the middle or second half of the 1st cent. AD. Likely the plate originated from nearby Grave 58 (Krajšek 2015: 143, Form III.1.2). A similar plate comes from Grave 22 at Šempeter, dated to the middle or second half of the 1st cent. AD (Kolšek 1977b: Pl. 13: 11).

CERAMIC DUMP AT LEVSTIKOVA ULICA 1

The 1986 excavations at Levstikova ulica 1 unearthed a ceramic dump (Fig. 1: 2). The recovered tableware and fine tableware sherds were of the same fabric as those from Workshop 1 at Mariborska cesta, located 300 m to the north. The wasters could thus either be associated with Workshop 1 or some other workshop (Krajšek 2015, 44). They include a plate (Fig. 2: 5) that resembles the Italian Consp. 18 to 20.4 forms or a Consp. B 2.7 base and only bears a few small patches of a red slip. The context is dated to the second and third quarter of the 1st cent. AD (Krajšek 2015, 142–143, Form III.1.1). A similar complete plate (Fig. 2: 6) is known from Grave 18 of the eastern necropolis at Šempeter, dated to the mid-1st cent. AD (Kolšek 1977: Pl. 11: 8), and a similar base from Grave 51 (second half of the 1st – first half of the 2nd cent.) in the same cemetery (Kolšek 1977: Pl. 22: 23).

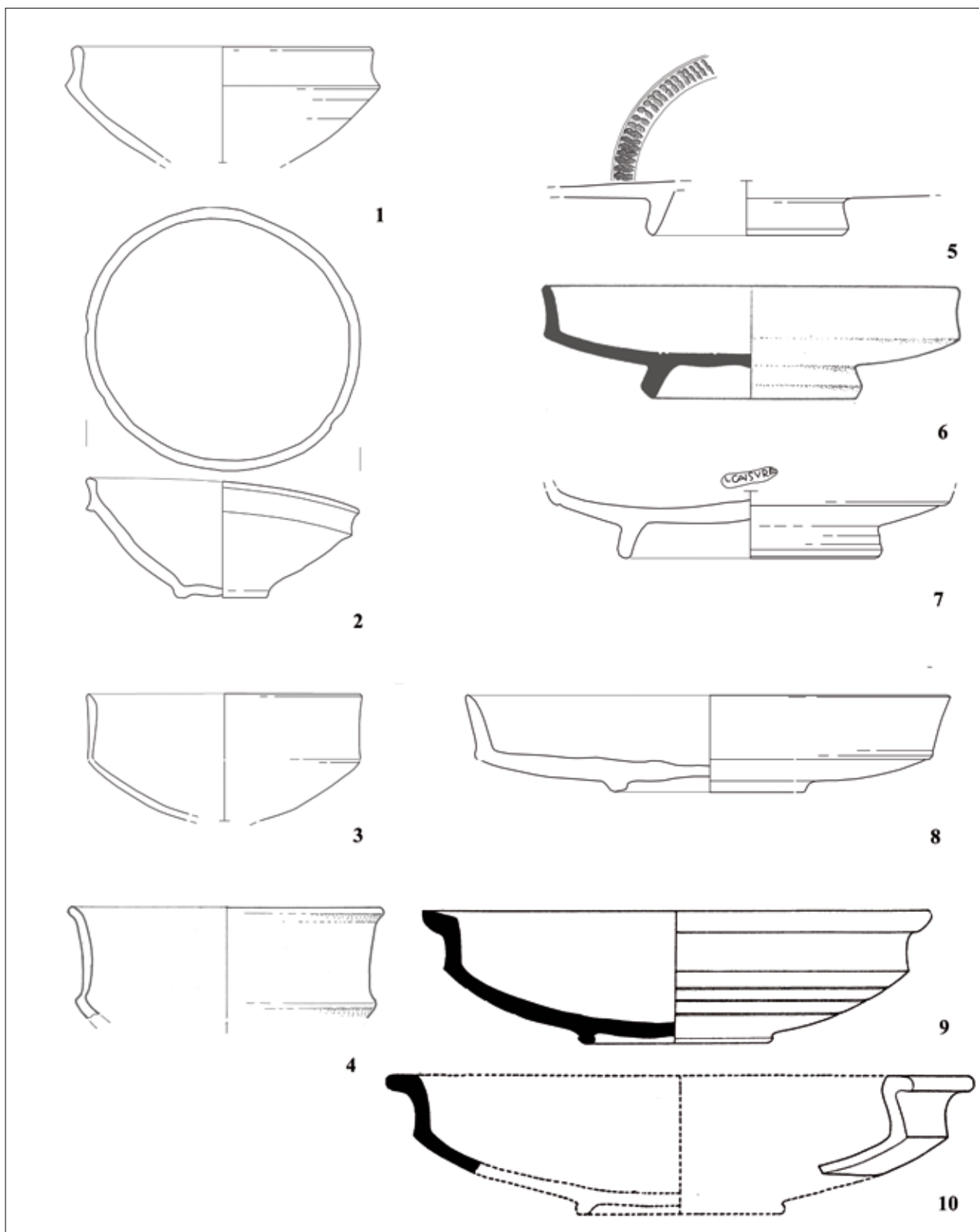

Fig. 2 Celeian Slip Ware. Mariborska cesta: 1–4, 7–8 (Drawings: Andreja Zalokar, Ida Murgelj); Levstikova cesta 1: 5 (Drawing: Maja Bausovac), Šempeter: 6 (Kolšek 1977, T. 11: 8); Gubčeva ulica: 9–10 (Kolšek 1972, Y149: 2,4) M 1:2.

SLIP WARE FORMS DERIVED FROM LATE LA TÈNE VESSELS

Grave 1 from Gubčeva street in Celje held two biconical plates (Fig. 2: 9, 10) with an everted rim, low foot and red slip. The associated goods date the grave to the mid-1st cent. AD (Kolšek 1972: Y149: 2, 4). In form, the plates were modelled on a Late La Tène plate found offered in the late Celtic sanctuary, which was an oxbow hole or a sinkhole pond at Mariborska cesta. It was unearthed in the layers of the early phases of its use dated towards the end of the 1st cent. BC (Krajšek 2015: 144, Form III.2.1).

WORKSHOPS 2 AND 3 AT MARIBORSKA CESTA



Fig. 3 Trefoil stamp for stamped decoration (photo J. Krajšek).

In the first half of the 2nd century, a pottery kiln (Workshop 2) was built at the northern end of the excavated area – some 50 m northeast of Workshop 1 (Fig. 1: 3). It was filled up with ceramic dump – burnt and distorted sherds – at the end of its use. A new workshop (3) with at least one kiln (Fig. 1: 4) was built on top of Workshop 1 in the second half of the 2nd century. A ceramic stamp with a trefoil motif (Fig. 3) was found in the area, in a layer dated to the first half of the 2nd cent. AD. The stamp was never used, but was presumably intended for stamping Celeian Slip Ware. Unfortunately, Workshops 2 and 3 yielded no other data on the slip ware production, suggesting that other types of pottery were being fired here (Krajšek 2015: 50–53).

POTTERS' QUARTER AT BREG

Since the 1950s, Vera Kolšek posited the existence of Roman pottery workshops at Breg, a part of the town on the south bank of the Savinja. Even before any kilns were discovered there, she based her hypothesis on a large dump of locally made pottery (Fig. 1: 5) found during the river engineering works on the Savinja (Bolta 1957; Kolšek 1959).

Pottery kilns came to light during the excavation in 2011, several pottery kilns of smaller dimensions in fact (Workshop 5), as well as a large number of dumped fragments of locally made pottery (Fig. 1: 6). The latter show a uniformity of shapes and fabrics. The workshop mainly produced tableware, slip ware and coarseware in the shapes used in the 2nd and 3rd cent. AD. This dating is confirmed by the radiocarbon analyses of the charcoal from the bottom of a kiln, pointing to the first half of the 2nd cent. AD (Bausovac, Krajšek 2014).

Evidence suggests that the pottery workshops at Breg were the main producers of Celeian Slip Ware, not only because of the number of excavated kilns, but also because of the large amounts of ceramic dumps of this kind of pottery that Vera Kolšek found in the 1950s. The shapes and ornaments here closely resemble most pottery found in the Roman layers of the 2nd and 3rd cent. AD in Celeia and its vicinity. It has also been observed that the emergence and development of new fabrics, ornaments and forms of Celeian Slip Ware is similar to the Pannonian Slip Ware in a wider region.



MACROSCOPIC DESCRIPTION OF THE FABRICS

A macroscopic analysis of the pottery from Mariborska cesta, the workshops at Breg and other archaeological sites in Celje and its vicinity recovered from the contexts of the 2nd and 3rd cent. AD has shown that the majority of the slip ware (plates, dishes, cups, beakers, jugs, tazze, fine ware...) has the same characteristics. This suggests a common, Celeian origin.

Most pots of Celeian Slip Ware were fired in an oxidising atmosphere (as in the case of Emonian Slip Ware). The N2.1 fabric (Fig. 4) is made of refined clay with moderate fine inclusions: fine particles of quartz and iron oxide (up to 0.3 mm in size), very fine (up to 0.1–0.2 mm) particles of carbonate, rare moderate flakes of very fine and fine mica (>0.1–0.2 mm). Rare voids (up

Fig. 4 Cylindrical jar with a red slip. Fabric N2.1 (photo J. Krajšek).



Fig. 5 Bowl with a grey slip. Fabric N2.2 (photo J. Krajšek).

to 0.4 mm in size) are visible. The vessels are hard fired, made on the potter's wheel. A light-coloured ceramic core bears a red slip, the colour of which ranges from orange to dark red and brown. The quality is not equal to the Italian sigillata imports, but very similar to Emonian Slip Ware.

At least a third of the vessels was fired in a reducing atmosphere, with a light to dark grey core and a dark grey slip (Fig. 5). The N2.2 fabric is the reduction variant of N2.1, in which particles are usually rarer and more equally sized.

Similarities with the N1.1 and N1.2 fabrics of the local tableware (without slip) are obvious; as are the similarities between the finer variants of the N3.1 and N3.2 fabrics of the thin-walled pottery.

CHARACTERISTIC CELEIAN SLIP WARE FORMS

In the second half of the 1st cent. AD, North Italian sigillata services – Consp. 39–46 cups and dishes – were still imported in great quantities (Conspectus 1990: 120–136; Zabehlicky-Scheffenecker 1992: 421–422; Schindler-Kaudelka and Groh 1994: 360: second half of the 1st – mid-2nd cent. AD). These forms were rarely reproduced in Celeian Slip Ware, especially Service A with everted rims of the Consp. 39/43 forms (Fig. 6: 2), common from the Flavian times or the late 1st cent. AD to the end of the 2nd cent. AD, in Pannonian Slip Ware unearthed in Emona (Plesničar - Gec 1977: 52), Poetovio (Istenič 1999: 696–699: PTS 7–11), Carnuntum (Adler-Wölfl 2004: 84, Sa 2.4, Te 2.4) and elsewhere in Pannonia (Leleković 2016: 609–610).

It seems that the local potters preferred deeper bowls with everted rims similar to the Gallic prototypes, with rims similar to Drag. 36 bowls. They were common in the 2nd cent. AD. The bowls (Fig. 6: 1) are usually almost undecorated, only bearing rouletting on the bottom interior. Oxidized examples are rare; grey bowls with a dark grey slip fired in a reducing atmosphere are more common. The wasters dump at Breg included distorted examples (Bausovac, Krajšek 2014: 177). Parallels are known across Pannonia and reach to the early 3rd cent. AD (Poetovio: Istenič 1999: 101, PTS varia 42; Emona: Plesničar Gec 1977: 52). Similar and contemporaneous are the bowls with a horizontal rim (Fig. 6: 3–4), which are related to the North Italian sigillata Consp. 40/44 forms, Service B. The rim and outer surfaces often bear rouletting. The later version, of the 4th and 5th cent. AD, resembled the African bowls (Fig. 6A: 1) and mortaria (Fig. 6A: 4) with a horizontal moulded rim in.

From the early 2nd cent. AD, a series of bowls was also modelled on Gallic vessels. These bowls, of the 2nd and 3rd cent. AD, were produced in either an oxidising or reducing atmosphere. The simple hemispherical bowls similar to the Drag. 40 form (Fig. 6: 4), those resembling the Drag. 37 bowls (Fig. 5, 6: 6–11) and examples with a rib resembling the Drag 44 bowls (Fig. 6: 12) could be undecorated or decorated with strips of rouletting in the interior or exterior of the vessel. A new decorative combination emerged on the forms resembling Drag 37 (Fig. 6: 10–11), with strips of rouletting alongside stamped decoration (rosettes, triangular trees, lozenges). The finds from the pottery kiln at Breg include later bowls with a moulded horizontal rim and bowls developed under the influence of the Drag. 36, 37 and 40 forms (Bausovac, Krajšek 2014: 177).

Conical cups (Fig. 7: 2–3) imitate the shape of the Gallic Drag. 33 form. In contrast, the variant without foot, with a plain flat base (Fig. 7: 1) is the result of the local creativity.

Different hemispherical bowls with an intense orange slip (Fig. 6A: 2–3) were found in the Late Roman graves and layers. Some have a flat base, without a foot-ring (Fig. 6A: 3).

Workshop 5 at Breg yielded many sherds that belonged to the local imitations of Raetian Ware. Beakers (Fig. 8, 7: 9) were of different sizes and quality, covered with a red slip and fired in an oxidising atmosphere. Their ornamentation was strongly influenced by Rhaetian models, decorated with rouletting, engraved reticular motifs and barbotine (dots and crescents). These vessels were common in the 2nd and 3rd cent. AD, although forms with different decoration or different slip (even lead-glaze) continued to be produced into the 4th and early 5th cent. AD (Krajšek 2015: 157; Bausovac, Krajšek 2014: 175–176).

There are also cups or beakers with concave or incurved walls (Fig. 9, 7: 10) fired in a reducing atmosphere and covered with a dark grey slip. They were not as popular as the imitations of the Raetian beakers, but do occur in the contexts of the

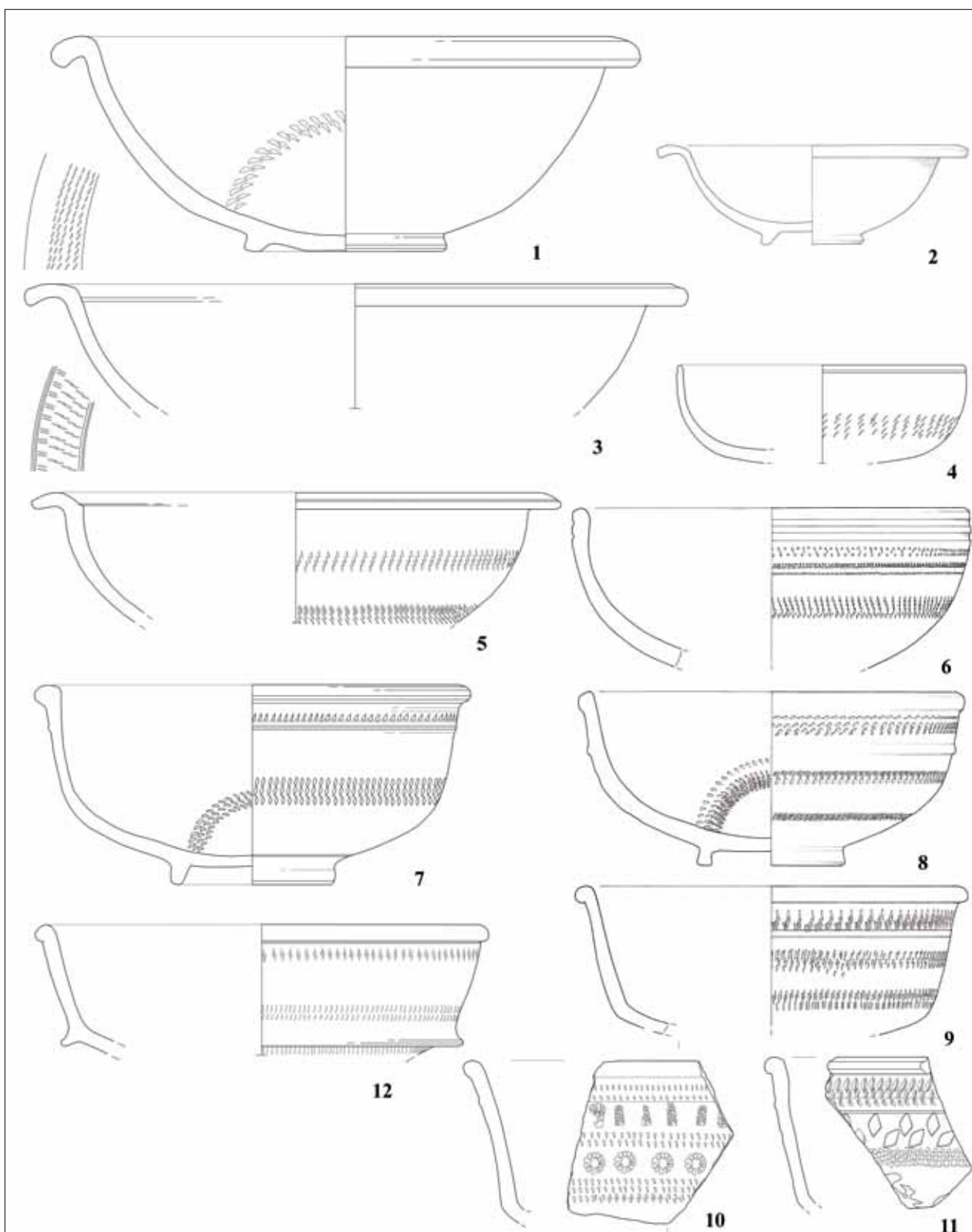

Fig. 6 Celeian Slip Ware. Mariborska cesta: 1, 3–5, 7, 10–12 (Drawings: Andreja Zalokar, Ida Murgelj); Mohorjev atrij: 2, 6, 8–9 (Drawings: Simona Tomažič) M 1:3.

2nd and 3rd cent. AD at most sites in Celje. The earliest context is Workshop 5 at Breg from the first half of the 2nd cent. AD, where a waster has an orange slip on a light coloured ceramic (Bausovac, Krajšek 2014: 176).

Some of the beakers (Fig. 7: 4–5), also present as wasters in Workshop 5 at Breg, are very simple in shape, undecorated and with a red slip only on the exterior (Bausovac, Krajšek 2014).

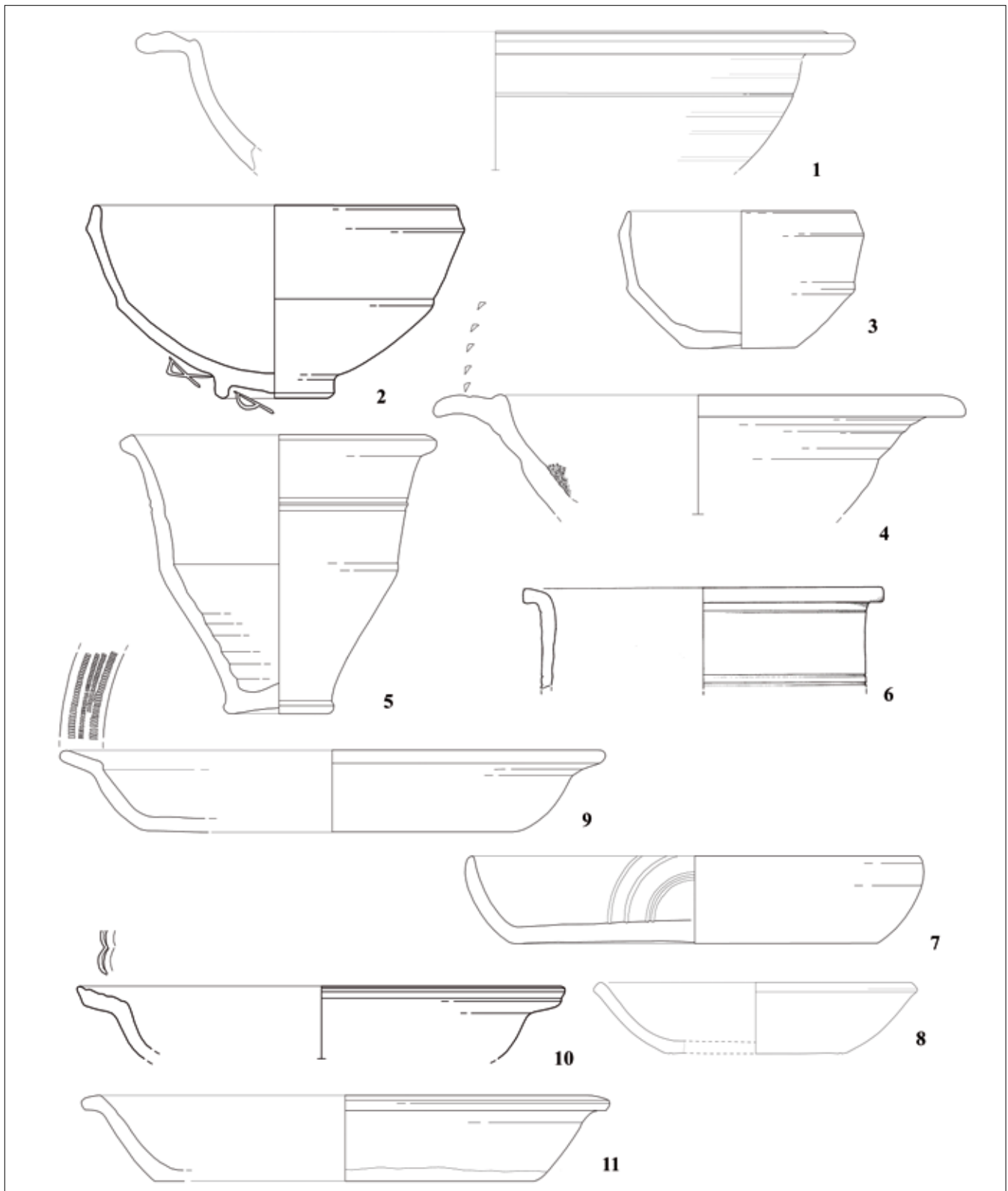

Fig. 6A Celeian Slip Ware. Mariborska cesta: 3–5, 7, 10 (Drawings: Andreja Zalokar, Ida Murgelj); Mohorjev atrij: 6 (Drawings: Simona Tomažič); Breg: 1–2; Osrednja knjižnica Celje: 8; *Evropa* 1979: 9, 11 (Drawings: Maja Bausovac) M 1:3.

Conical beakers (Fig. 7: 6–8) are undoubtedly imitations of the Isings 21 glass beakers with polished decoration from the end of the 1st or the 2nd cent. AD (Isings 1957: 37–38). The Celeian ceramic examples could be undecorated or stamped with circular, lozenge or oval motifs. They were fired in a reducing atmosphere and covered with a grey and very shiny slip in greenish shades. The discarded pottery sherds at Breg yielded parts of such vessels in different sizes.

Cylindrical jars (Fig. 4, 6A: 5–6) are usually light in colour, covered with a red slip, fired in an oxidising atmosphere and found in contexts from the 2nd and 3rd cent. AD.

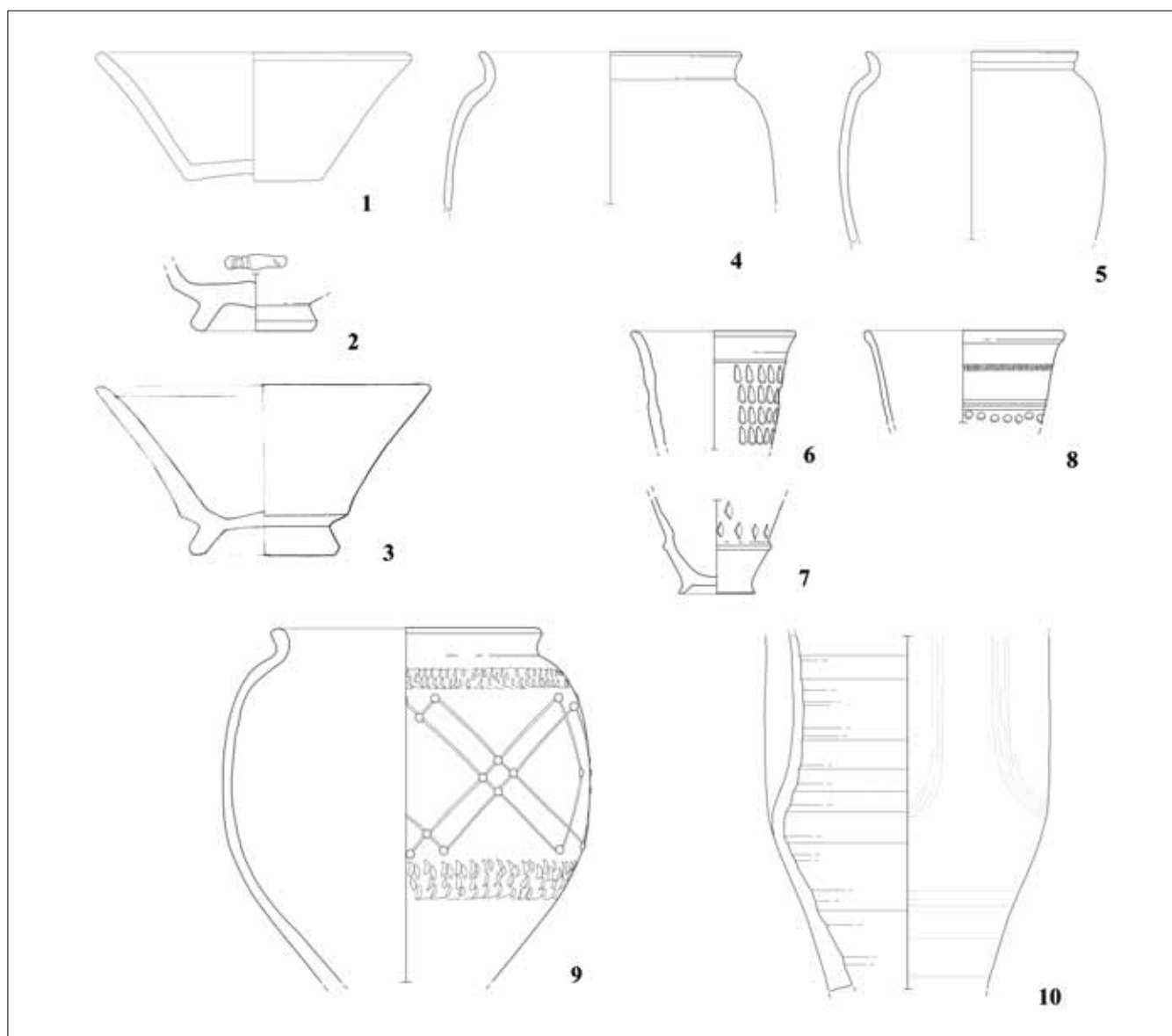

Fig. 7 Celeian Slip Ware. Mariborska cesta: 2–3, 6–9 (Drawings: Andreja Zalokar, Ida Murgelj); Breg: 4–5, 10; Osrednja knjižnica Celje: 1 (Drawings: Maja Bausovac) M 1:3.



More utilitarian is the slip ware production of commonware plates (*Soldatenteller*) (Fig. 6A: 7–8) throughout the Roman period. In the Late Roman levels, commonware plates evolved to imitate the Hayes 58 (Fig. 6A: 11) and Hayes 59 African plates or dishes (Fig. 6A: 9–10), dated to the 4th and early 5th cent. AD.

Even the mortaria (Fig. 7: 4) from the burial and habitation layers of the 2nd, 3rd and 4th cent. AD were covered with a red slip (Krajšek 2015: 140; Krajšek, Bausovac 2014).

Fig. 8 Beaker resembling Raetian Ware (photo J. Krajšek).



Fig. 9 Beaker with indented walls (photo V. Berk).

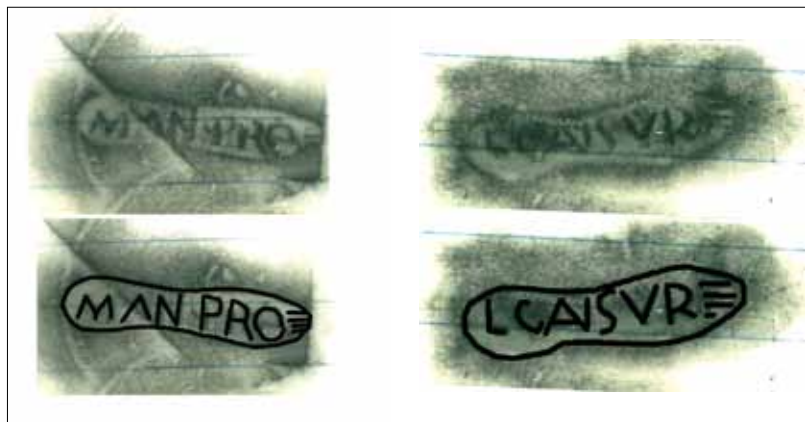

Fig. 10 Stamps on Celeian pottery (author J. Krajšek).

LOCAL POTTERS' STAMPS

Stamps on slip ware reveal the existence of two local potters or workshops from Celeia. Sherds with such stamps were found at Mariborska cesta. On the bottom of a red slip plate or bowl (Fig. 2: 7, 10: A), a unique *in planta pedis* stamp could refer to a Celeian potter; the letters L. CAI[...] SVR[...] are visible. A base fragment of a cup (Fig. 7: 2) that resembles the Drag. 33 Gallic sigillata form with a *planta pedis* stamp was also found, but the fragment is too small for an exact typological identification and only the letter S at the beginning is visible. Two commonware plates (*Soldatenteller*) bear the *planta pedis* stamps of the potter MAN.PRO (Fig. 10: B) (Krajšek 2015).

CONCLUSIONS

The plates similar to the Italian sigillata Consp. 18 to 20 plates, Consp. 22, 26, 27 cups or the forms developed from Late La Tène plates show that the early production of slip ware in Celeia began in the second or third quarter of the 1st century AD.

Even earlier imitations of Italian terra sigillata (Consp. 22), from the first third of the 1st cent. AD, were produced in Workshop 1 at Mariborska cesta, but were without a slip. Workshop 1 was active already before the town was conferred its municipal rights and build *ex novo* in Claudian times. The Italian type kilns, Italian ceramic forms and manufactory type of organisation could not be the result of an indigenous development; rather we can assume that the investment, workers and know-how came from elsewhere, probably with the Roman or Italic newcomers.

TINA ŽERJAL
Arhej d. o. o.,
Drožanjska 23,
8290 Sevnica;
Oddelek za arheologijo
Filozofska fakulteta, Univerze v Ljubljani
Aškerčeva 2, 1000 Ljubljana
tina.zerjal@guest.arnes.si

JURE KRAJŠEK
Trg Celjskih knezov 8
3000 Celje
jurekrajsek@pokmuz-ce.si

From the middle or second half of the 1st and early 2nd cent. AD onwards, the quantity of imported ware from North Italy decreased. The local potters started their own mass production, slip ware (Red or Black Slip Ware) included. The analysis of the pottery from Mariborska cesta has enabled us to identify the forms and fabrics of Celeian Slip Ware and distinguish them from the imported ones. The Celeian pottery productions encompass great numbers of large bowls (similar to the Drag. 37, Drag. 35/36 or Consp. 39, Drag. 40, Drag. 44 forms), cups (similar to Drag. 35/36 or Consp. 43, Drag. 33), dishes, platters or plates (special forms similar to Consp. 18–20; African forms of Hayes 58 and Hayes 59), imitations of Raetian Ware beakers, imitations of glass beakers (Isings 21), mortaria (similar to Raetian mortaria), fine jars, jugs and plates (*Soldatenteller*). Celeian Slip Ware was still produced in the early 5th century.

The term *Pannonische Glanztonware* (PGW) (coined by Adler-Wölfl 2004; latest summary by Leleković 2016) or now Pannonian Slip Ware (PSW) encompasses a huge production ranging from high-quality (very similar to the Italian and Gallic sigillata vessels) to low-quality products that emerged across the Pannonian provinces and neighbouring regions. Similar productions were also observed in the province of Noricum (for example in Celeia) and even *Regio X* in Italy, with the local sigillata or Red Slip Ware at Emona.

BIBLIOGRAPHY

- Adler-Wölfl, K. 2004, *Pannonische Glanztonware aus dem Auxiliarkastell von Carnuntum. Ausgrabungen der Jahre 1977–1988*, Wien.
- Bausovac, M. 2014, *Vivas felix, Celeia, Arheološko najdišče Osrednja knjižnica Celje*, Celje.
- Bausovac, M., Krajšek, J. 2014, Lončarske radionice na Bregu u Celju / Pottery workshops at Breg in Celeia, in: *Rimske keramičarske i staklarske radionice: proizvodnja i trgovina na jadranskom prostoru, zbornik II. međunarodnog arheološkog kolokvija, Crikvenica, 28.-29. listopada 2011.* = *Roman pottery and glass manufactures: production and trade in the Adriatic region: proceedings of the 2nd International Archaeological Colloquium*, Crikvenica (Croatia), 28th–29th October 2011, Lipovac-Vrkljan, G., Konestra, A. (eds.), Zagreb-Crikvenica, 173–190.
- Bausovac, M., Krajšek, J. 2020, *Municipium Claudium Celeia*, Celje.
- Bolta, A. 1957, Rimsko grobišče na Bregu v Celju, *Arheološki vestnik* 8, 317–327.
- Consp. 1990, *Consp. 1990, Conspectus formarum terrae sigillatae italico modo confectae*, Materialien zur römisch-germanischen Keramik 10, Bonn.
- Cuomo di Caprio, N. 1985, *Ceramica in archeologia. Antiche tecniche di lavorazione e moderni metodi di indagine*, Roma.
- Gaspari, A., Krempuš, A., Novšak, M. 2007a, Preliminary report on the discovery of a Late Celtic sanctuary and two Gallo-Roman temples in Celje (Slovenia), in: *L'âge du Fer dans l'arc jurassien et ses marges. Dépôts, lieux sacrés et territorialité à l'âge du Fer. Actes du XXIXe colloque international de l'AFEAF vol. 2*, PH. Barral, A. Daubigney, C. Dunning, G. Kaenel, M.-J. Roulière–Lambert (eds.), Besançon, 835–840.
- Gaspari, A., Krempuš, A., Novšak, M. 2007b, Die Neuen spätkeltischen und frühkaiserzeitlichen Heiligtümer von Celeia, in: *Götterwelten: Tempel, Riten, Religionen in Noricum. Katalog zur Sonderausstellung im Landesmuseum Kärnten*, F. W. Leitner, H. Dolenz (eds.), Klagenfurt, 39–44.
- Isings, C. 1957, *Roman Glass from Dated Finds*, Gröningen, Djakarta.
- Istenič, J. 1999, *Poetovio, zahodna grobišča I: grobne celote iz Deželnega muzeja Joanneum v Gradcu*, Katalogi in monografije 32, Ljubljana.
- Kolšek, V. 1959, Nekaj prispevkov k topografiji rimske Celeje. *Celjski zbornik* 1959, 230–257.
- Kolšek, V. 1972, *Les nécropoles de Celeia et de Šempeter*, Inventaria Archaeologica Jugoslavija 16, Beograd.
- Kolšek, V. 1977, *Vzhodni del antične nekropole v Šempetru*, Katalogi in monografije 14, Ljubljana.
- Krajšek, J. 2015, *Keramika rimske Celeje*, unpublished PhD thesis, University of Ljubljana, Celje.
- Krajšek, J., Bekljanov Zidanšek, I., Žerjal, T. 2019, Thin-walled pottery from Celeia: the evidence from Mariborska cesta excavation, *Chronologie und vergleichende Chronologien zum Ausgang der Römischen Republik und zur Frühen Kaiserzeit*, H. Dolenz, K. Strobel (eds.), Kärntner Museumsschriften Band 87, 333–353.
- Leleković, T. 2016, Local imitations of imported fine tablewares from Southern Pannonia, *Acta Rei Cretariae Romanae Fautores* 44, 609–618.
- Novšak, M., A. Gaspari, R. Krempuš, J. Krajšek 2004, *Mariborska cesta v Celju, III. etapa obnove. Poročilo o izvajanju zavarovalnih arheoloških izkopavanj v letih 2003 in 2004*, unpublished excavation report, archives of the ZVKDS, o.e. Celje, Celje.
- Plesničar Gec, L. 1977, *Keramika emonskih nekropol / The pottery of Emona necropolises*, Dissertationes et monographiae 20, Ljubljana.
- Zabehlicky-Scheffenecker, S. 1992, Terra sigillata tardopadana, *Rei Cretariae Romanae Fautorum Acta* 31–32, 1992, 415–443.

SAŽETAK
CELEJSKA KERAMIKA S PREMAZOM.
PANONSKA KERAMIKA S PREMAZOM (PSW) IZ CELEJE:
NALAZI IZ ISTRAŽIVANJA MARIBORSKE CESTE

Ključne riječi: Celje, Celeia, Noricum, rimsko razdoblje, celejanska keramika s premazom, keramičarska radionica.

U najjužnijem municipiju u Noriku zvanom Municipium Claudium Celeia (danas Celje, Slovenija) lokalna proizvodnja keramike započela je početkom 1. stoljeća nove ere u Radionici 1 na nalazištu Mariborska cesta, gdje su se proizvodile rane imitacije talijanske terra sigillata. Nakon toga proizvodnja celejanske keramike s premazom (Celeian Slipped Ware) seli se u keramičarsku četvrt na Bregu (Radionica 5). Oblici i strukture celejanske keramike s premazom Ware pronađeni prilikom istraživanja Mariborske ceste uspješno su prepoznati i odvojeni od uvezenih. Celejanska keramika s premazom obuhvaća obsežnu proizvodnju od visokokvalitetnih proizvoda (vrlo sličnih talijanskim i galskim sigilatnim posudam ili recijskoj keramici) do posuda i oblika loše kvalitete slične onim, koji su se pojavili kroz panonske provincije i susjedne regije. Prepoznali smo ogroman broj velikih zdjela, šalica, tanjura, čaša, mortarija, finih lonaca, vrčeva i tanjura u kontekstima 2. i 3. stoljeća naše ere. U 4. i početkom 5. stoljeća celejanska keramika s premazom još se uvijek proizvodi.

FINE TABLEWARE OF POETOVIO PRODUCTION: A SHORT SUMMARY

We present a short introduction to state what we already know about Pannonische Glanztonware made in Poetovio from the graves of the western cemeteries. We will add new discoveries about fine tableware of the local production from four different excavation sites in the town area of Ptuj: Vičava and Rabelčja vas.

Key words: Poetovio, Vičava, Rabelčja vas, tableware, Pannonische Glanztonware

INTRODUCTION

All of the four excavation sites are located on the left site of the Drava riverbank of Ptuj in the former town Poetovio. Two of them are in the area of Vičava, the former Military building housing now the Institute for the Protection of Cultural Heritage of Slovenia and the Dominican monastery right around the corner (Fig 1). On both sites, remains of the Roman settlement were found. The other two considered places are situated at Rabelčja vas. There a residential area was unearthed when Ptuj High school was remodelled while under the Retirement home a much more important dig provided one more Roman pottery production site. The western cemetery, published by Janka Istenič is positioned at Zgornja and Spodnja Hajdina (Fig 1).

THE WESTERN CEMETERY

The Western cemetery of Poetovio was detected by an old excavation of the 19th century. Almost 20 years ago, Janka Istenič published the finds (Istenič 1999: 2000). Typology supplemented by chemical analyses and refiring investigations as well as chronology of the Poetovian pottery production offer a sound basis for any further investigation of the colony's material heritage.

Among the tableware, which belongs to the southern class of Pannonische Glanztonware are the most common (<https://www2.rgzm.de/Transformation/Magyarorszag/Glanztonware/GlanztonwareEnglisch.htm>, Consulted November 21st 2020), plates and bowls similar in shapes to Italian Terra Sigillata (Fig. 2) Inspiration from western sigillata can be found only rarely (Istenič 1999: 102). The timeframe in the graveyard covers the span from the 40ies of the 1st century and the end of the 2nd century (Istenič 1999: 91-101).

Locally manufactured thin walled drinking ware present in the graves (Fig. 3) is dated in the 1st and 2nd century, again following the originals from North Italy (Istenič 1999:113-114).

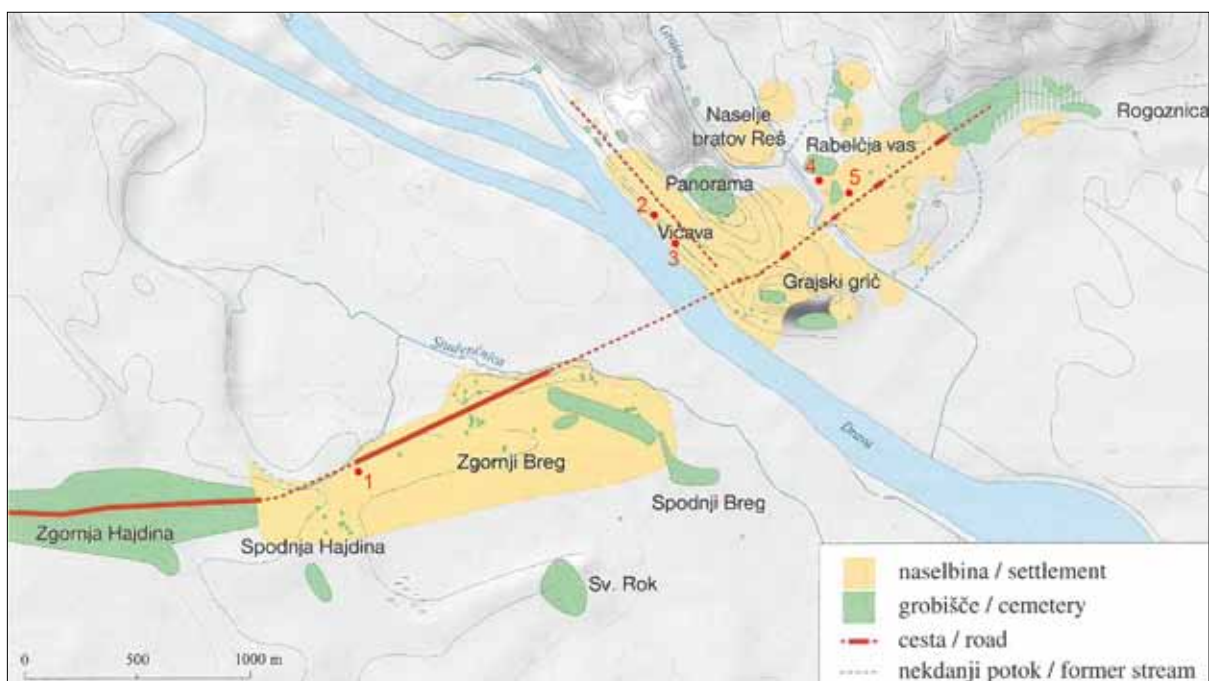

Fig. 1 The excavation sites: 1 – The Western cemeteries, 2 – The Military building, 3 – The Dominican monastery, 4 – The High school, 5 – The Retirement home (Horvat, Dolenc-Vičič 2010, Fig. 2).

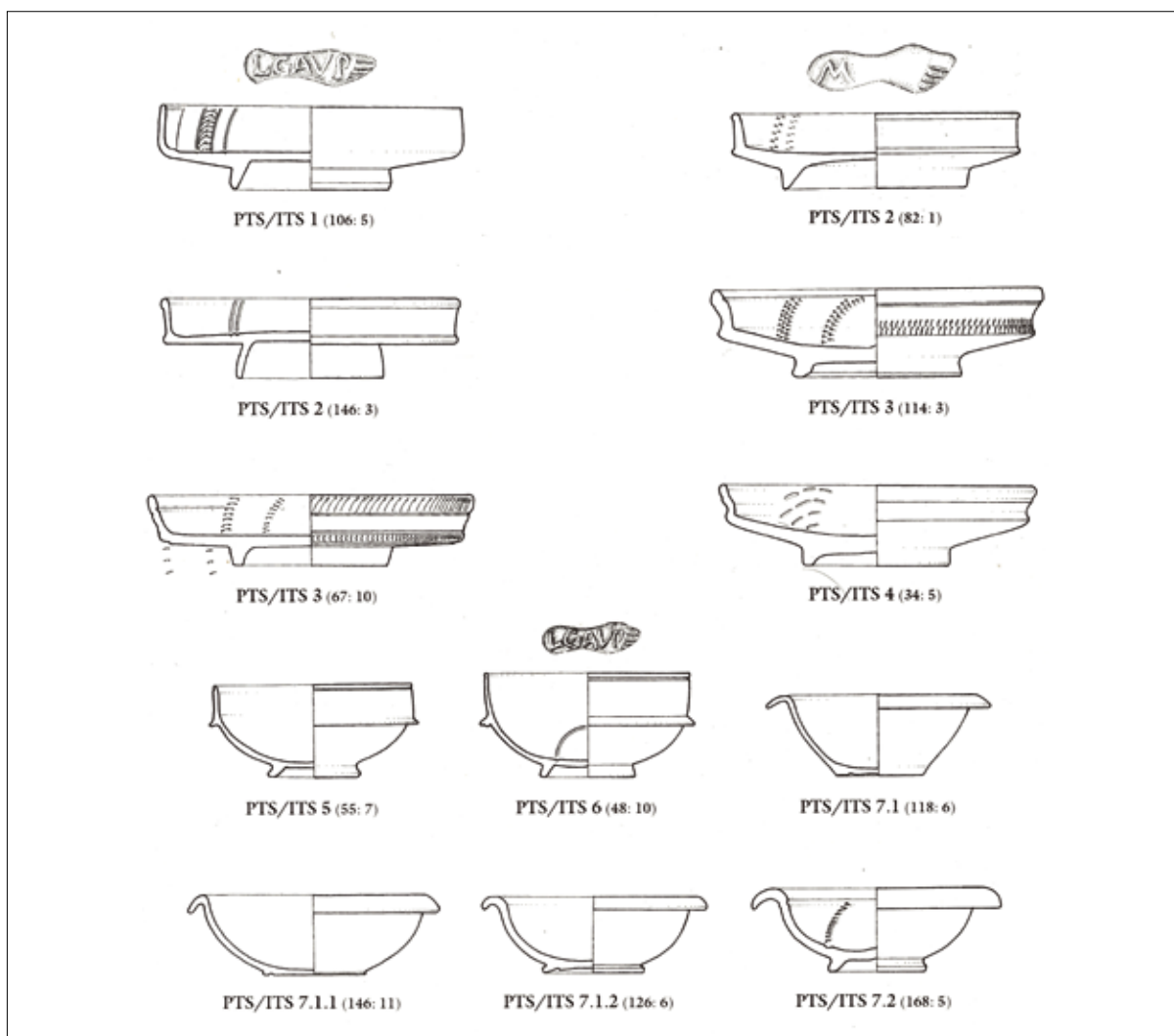

Fig. 2 Imitations of terra sigillata of Poetovian production (Istencič 1999, fig. 79).

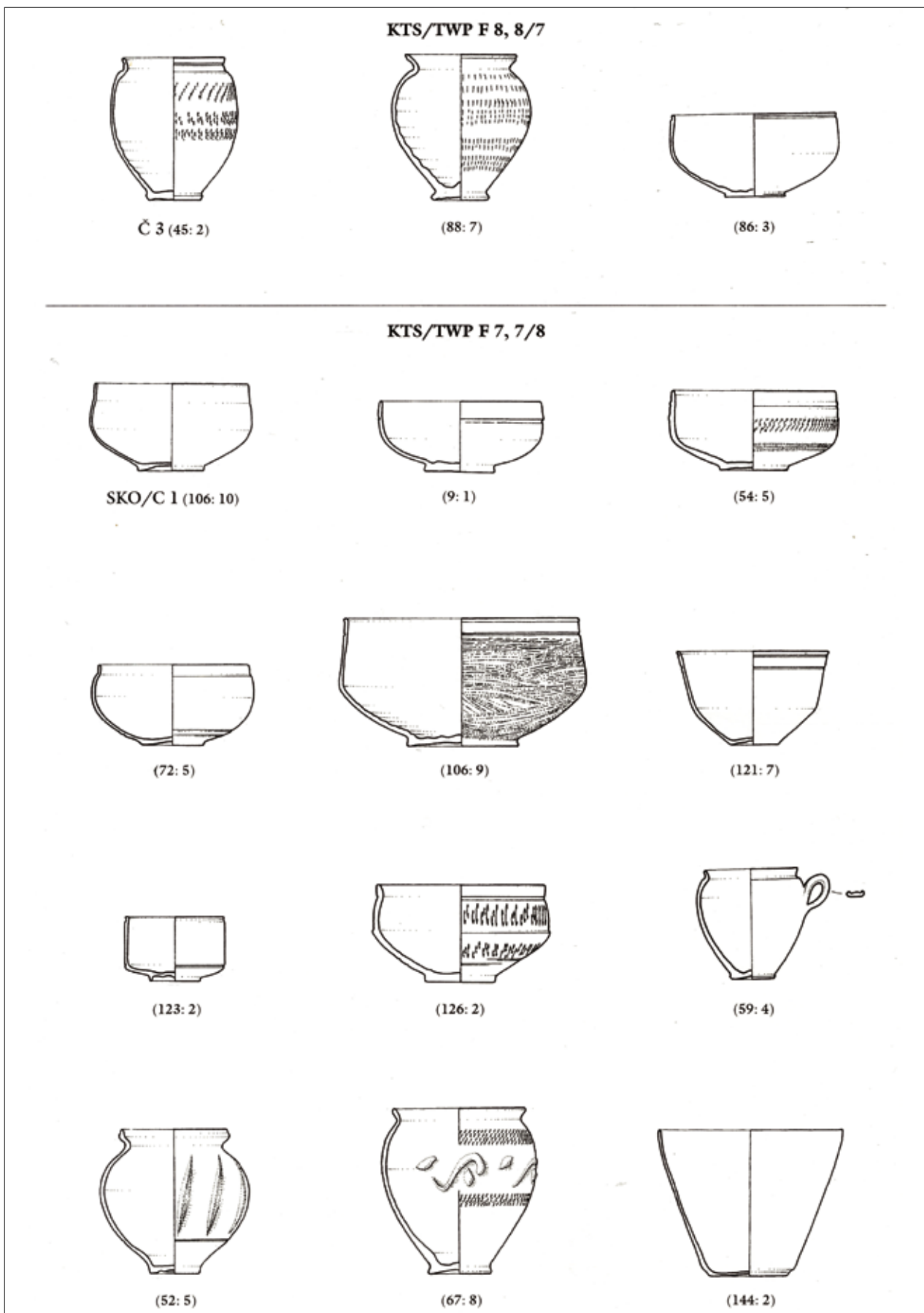

Fig. 3 Poetovian made thin walled pottery (Istenič 1999, fig. 98).

The grave goods included different kinds of locally made drinking cups and beakers and footless plates and platters known as Soldatenteller (Fig. 4). The important number of lamps encompasses both locally made and imports from Italy. Thin walled pottery made mainly in Italy is frequent.

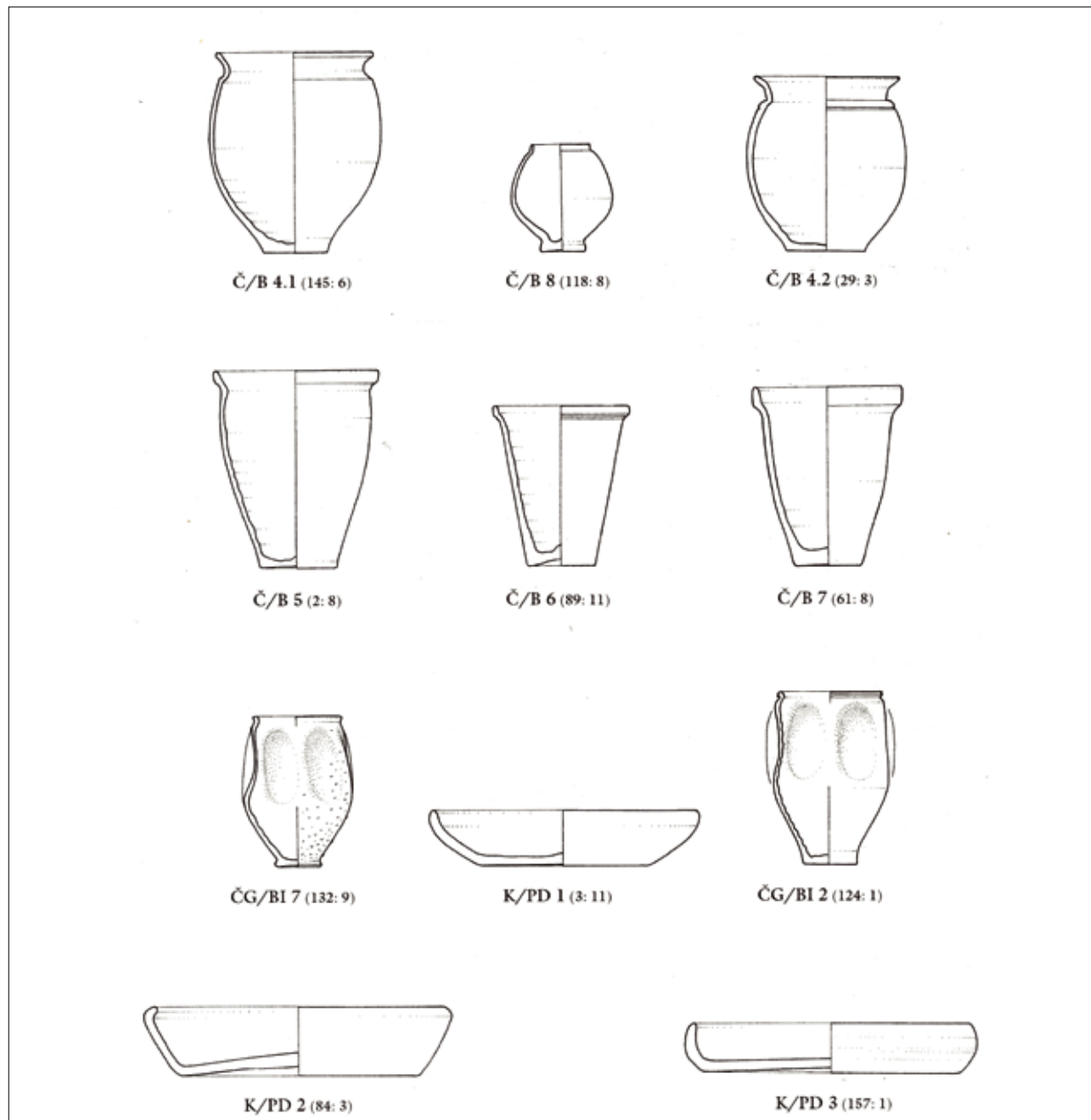

Fig. 4 Poetovian made beakers and plates (Istenič 1999, fig. 102).

Local pottery predominates in graves of all periods, but imported pottery is common in the 1st century and the first half of the 2nd century. The crucial period, when the number of imported artefacts apparently declines, falls approximately at the beginning of the second half of the 2nd century (Istenič 1999: 170).

THE MILITARY BUILDING

The fine tableware from the excavation at the Military building carried out in 2010 and 2011 held a stratigraphy of four separated phases. Some overlapping can be noticed for the phases; however, substantial changes in the fine tableware assemblage can be observed. The first phase of the 2nd quarter of the 1st century (Fig. 5) furnished no fine tableware belonging to local Poetovian production. In the 2nd phase dated from the 2nd quarter of the 1st century until the beginning of the 2nd century (Fig. 5), Poetovio made dinnerware is quite numerous. Nevertheless, it would be difficult to declare that in the first phase distribution of locally made tableware was still weak. The fact could be specific to just this

excavation and needs more evidence. Bowls inspired by the Italian sigillata shapes Consop. 34 and 43 come along with the typical PGW Drag. 37 (Schindler, Janežič 2019: 117-118). The majority of local PGW was found in the third phase covering the end of the 1st century and the second half of the 2nd century (Fig. 5). Typology mostly shows various bowls and plates.

Unlike in phase 2 they are rarely connected any more with Italian sigillata while shapes, not decoration, have a strong link with the role models of South Gaulish Sigillata. Moreover, profiles, but rouletting decoration as well (Fig. 6), take inspiration of African red slipware, perhaps transmitted over Medioadriatica.





	1st PHASE: 2nd quarter or the middle of the 1st century AD	2nd PHASE: 2nd quarter of the 1st and the beginning of the 2nd century AD	3rd PHASE: from the end of the 1st till the second half of the 2nd century AD
BEAKERS	x		
BOWLS	x		
PLATES	x		

Fig. 5 Poetovian fine ware from the excavations at the Military building (drawings: S. Ohman, design: N. Svenšek).

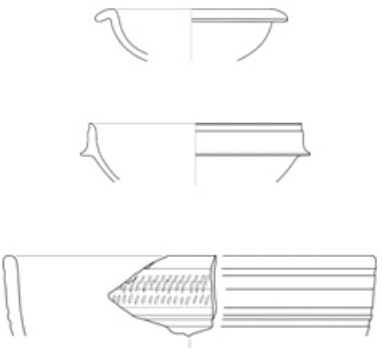
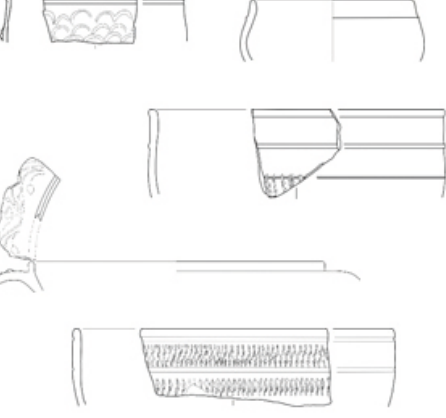

Fig. 6 PGW bowl with rouletting decoration (Photo: S. Pukšič).

Beakers, with even thinner walls than before and sometimes very fine are in the minority. Soldatenteller and some pieces of fine PGW plates where again analogies with African red slip wares can be traced complete the panorama (Schindler, Janežič 2019: 118). The stratigraphic units of fourth phase were damaged during the construction of the military building. They contained substantially less material than other phases and the pottery finds bear no notable difference with the third phase (Schindler, Janežič 2019: 119).

THE HIGH SCHOOL

Excavations at Ptuj High School in 1998 touched part of the mid- Roman settlement which is dated from the second half of the 3rd till the 4th century (Janežič 2008: 57). Locally made fine tableware comes in large numbers, with only slight remains of imported sigillata. Beakers are rare due to the increased use of glassware. Fine tableware as a total seems reduced to PGW bowls in a wide variety of different shapes, sizes and surface treatments (Janežič 2008: 28-32). Similarity with Italian sigillata is gone. In the shapes of bowls and deep dishes inspirations come from ARS (Fig. 7). Eastern Sigillata B did not leave a special mark in the production of Poetovio (Janežič 2008: K 314, K 319, K 372, K 380, K 513, K 576). The same happens with plates and platters, unless one finds allusions to Hayes 59 in some Soldatenteller (Janežič 2008: K 160 – K166, K 402 – 405, K 415).

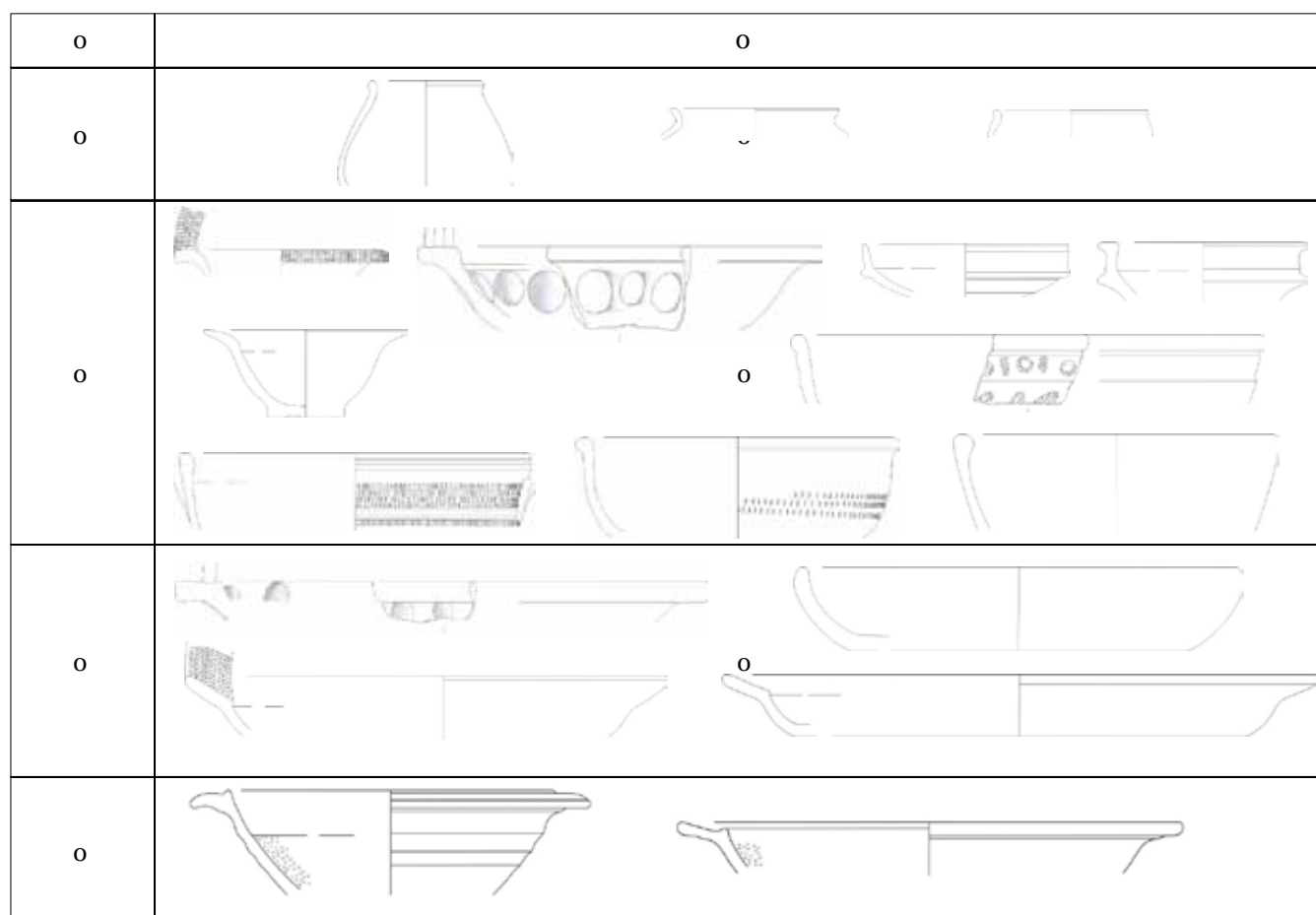

Fig. 7 Poetovian fine ware from the excavations at the High school (drawings: S. Ohman, design: N. Svenšek).

A diversification in the standardization of sizes appears in analogy to the productions of Mediterranean mid to late Roman, not only in Africa but also in Greece, Asia Minor and the Levante. Diversification also covers the surface treatment, with locally made lead-glaze side by side with the usual Glanzton, brush painting as well as some shy polishing. Mortaria with or without glaze applied on the inner side only were all the fashion and used on the dining table. Differences in shape adaptation are evident.

THE DOMINICAN MONASTERY

Excavations at the Dominican monastery carried out in 2012 limited to statically safe depth only, again revealed the Roman settlement (Lazar et al., in print, 17). Remains from the first half of the 2nd century and older were not reached (Lazar et al., in print, 71). The repertoire of Poetovio made tableware (Fig. 8) belongs to the second half of the 2nd century until the 4th century (Lazar et al., in print, 71). High analogies to Ptuj High school levels are visible.

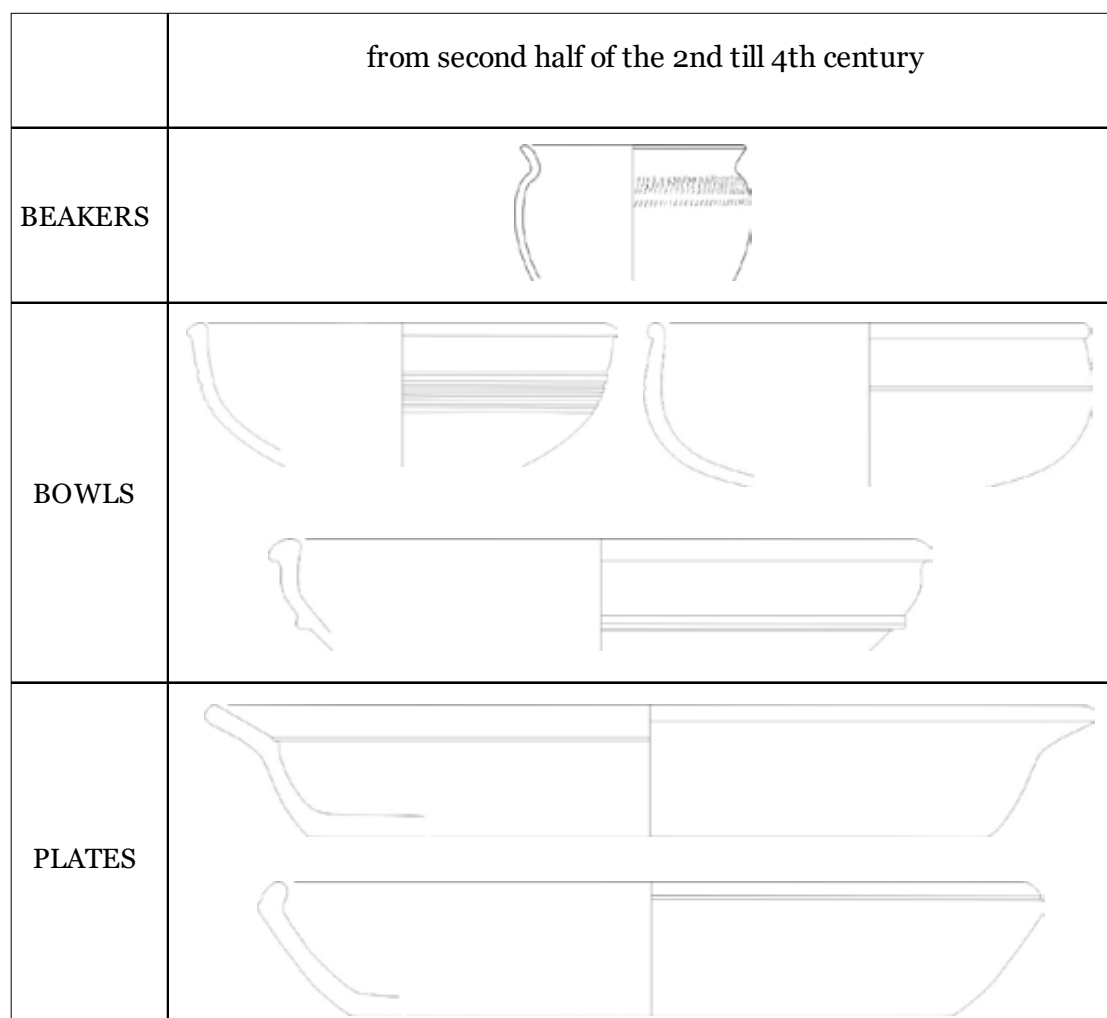

Fig. 8 Poetovian fine ware from the excavations at the Dominican monastery (drawings: S. Ohman, design: N. Svenšek).

The rare drinking vessels of this date can be defined by the typology following Niederbieber but since this is not really remarkable, so international fashion should be sufficient to classify them. Large PGW bowls Drag 37 with or without rouletted zoning sometimes reminiscent of Rheinzabern and Trier are the most common. Ringschüsseln were part of the repertoire of Lezoux, and Poetovio boasts with late derivatives. Late plates definitely inspired by the African role models, typologically close to Hayes 42 and 62 have to be added to what was in use in Poetovio. It still has to be seen whether they circulated out of the town (Fig. 8).

THE RETIREMENT HOME

Excavations in the years 1985, 1992 and 2001 at Ptuj Retirement home revealed the remains of a pottery workshop (Janežič 2019: 62). The finds show a different pattern when compared with the settlements and clearly point to a multi-repertoire workshop where all kinds of pottery were made, from fine tablewares to kitchen implements and storage vessels, and among them of course also PGW (Janežič 2019: Fig. 9). Large painted biconical pots in Neoceltic tradition (Fig. 10) come along with Faltenbecher slipped and sanded and other less trivial drinking vessels influenced by imports of genuine Raetian cups and beakers (Fig. 9). They come in sets with one-handed jugs and bottles all of them quite frequent (Janežič 2019: Fig. 9).



Fig. 9 Beakers from the excavations at the Retirement home (drawings: S. Ohman, design: N. Svenšek).



Fig. 11 Bowl similar to form Ritt. 12 from the excavations at the Retirement home (Photo: D. Ciglar Milosavljević).

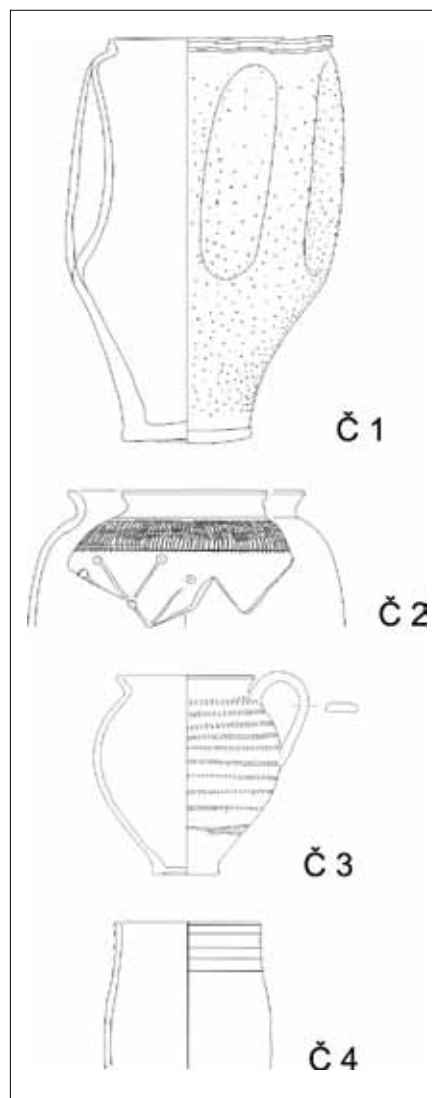

Fig. 10 Large biconical pot with painted decoration from the excavations at the Retirement home (Photo: D. Ciglar Milosavljević).

Soldatenteller look extremely varied, but the slight differences in shape due to hasty handling were not purposely done to let differences appear (Janežič 2019: Fig. 9). PGW abounds in Drag 37 bowls strangely uniform in shape and surface treatment (Janežič 2018, 157). In addition, some of the bowls were inspired by the African bowls Hayes 9 and by Rheinzabern dishes form Lud. Si, Lud. Sm and Ritt. 12 (Fig. 11; Janežič 2018: 155-160). Mortaria (Fig. 12) usually are bare of slip or glaze, while piecrust vessels are always buff and smooth (Janežič 2018: 162-168). The workshop can be dated from the beginning of the 2nd till the middle of the 3rd century (Janežič 2019: 74)

FIRST CONCLUSIONS

The beginning of fine tableware of Poetovio production can be fixed around the middle of the 1st century and the date coincides with the arrival of the Legio XIII from Vindonissa. Four excavations within different sectors of the Roman town in comparison with the extended graveyard lead to some considerations in repertoire and local circulation of the locally manufactured fine tablewares. The thin walled cups and beakers fabricated in Peotovios workshops are influenced by the Italian imports. In the pottery used in the settlement, they played a minor role. Early beakers are similar to small cooking pots (Fig. 13). Cups, plates and bowls took their inspiration from Italic Sigillata while only some rare pieces show



Fig. 12 Mortaria from the excavations at the Retirement home (Photo: D. Ciglar Milosavljević).

features of classical PGW. Among the plates the ever-present Soldatenteller are long living, from the 1st well into the 4th century (Fig. 13). Some of them will later be inspired by ARS and could only very rarely be assimilated to the repertoire of Eastern Sigillata B as could be shown elsewhere. From the end of the 1st and the beginning of the 2nd century, we notice an increasing number of Poetovian tableware (Fig. 13). Beakers with very thin walls give credit to the locals craftspeople. As for shapes and surface treatment they follow international fashion. Among cups and bowls, a rich variety appears, mainly oriented in form with a high influence of South and Central Gaulish Sigillata, but also of Belgian wares.

The floruit of the manufactures takes place to the 2nd and the 3rd century. Tableware is a central feature in the potter's repertoire. *Faltenbecher* seem absent in the first phase of the pottery production (Fig. 13). Just some rare pieces are known

	2nd quarter or the middle of the 1st century AD	2nd quarter of the 1st and the beginning of the 2nd century AD	from the end of the 1st till the second half of the 2nd century AD	from the beginning of the 2nd till the middle of the 3rd century	from the second half of the 3rd till the 4th century
BEAKERS	x				
BOWLS	x				
PLATES	x				

Fig. 13 Summary of the visible change over the time in the five excavation sites (drawings: S. Ohman, design: N. Svenšek).

in graves from the second half of the 1st till the middle of the 2nd century. Based on the settlement finds their major production dates later, between the beginning of the 2nd and the middle of 3rd century. This is also the prime time for the production of large PGW bowls with strong Poetovian character that show prevalent influence from ARS. From the second half of the 3rd till the 4th century PGW is still popular while the number of glazed bowls, *mortaria* and plates is rising (Fig. 13).

Except for the well-studied Western graveyards, up to now, Poetovio provides only limited published access to outline the production contextually and it is a fact that cemeteries are not the perfect place to study ensembles and changes. Iva Mikl Curk's early hypothesis that the main push for the pottery production came with the potters migrating along with the soldiers (Mikl Curk 1997: 51), when the *Legio decima tertia* arrived from *Vindonissa* was confirmed and embedded in a chronological background. Poetovio potters took inspiration from all main imported fine wares – Italic, Eastern, perhaps a bit shy, South and Central Gaulish as well as ARS. Actually, it seems that the potters traveling with the army transferred some of the south Pannonian shapes to *Vindobona*, when the *Legio* was sent there at the end of the 1st century.

BIBLIOGRAPHY

- Horvat, J., Dolenc-Vičič A. 2010, *Arheološka najdišča Ptuja: Rabelčja vas / Archaeological sites of Ptuj: Rabelčja vas*, Opera Instituti Archaeologicae Sloveniae 20, Ljubljana.
- Istenič, J. 1999, *Poetovio, zahodna grobišča I / Poetovio, the Western Cemeteries I*. Katalogi in monografije 32, Ljubljana.
- Istenič, J. 2000, *Poetovio, zahodna grobišča II: katalog / Poetovio, the Western Cemeteries II: catalogue*, Katalogi in monografije 32, Ljubljana.
- Janežič, M. 2008, *Poznorimski naselbinski sklop Ptuj, Gimnazija (sektor II), s podrobnejšo analizo keramičnega zbira*, Diplomski rad, Ljubljana.
- Janežič, M. 2019, *Sledovi lončarske proizvodnje na območju Doma upokojencev Ptuj*, Zbornik Pokrajinskega muzeja Ptuj – Ormož, Ptuj.
- Janežič, M. 2018, *Lončarska obrt v Petovion: Sledovi lončarske proizvodnje in analiza keramičnega gradiva na območju Doma upokojencev Ptuj*, Doktorska disertacija, Koper.
- Lazar, L., Janežič, M., Veršnik, N. in print, *Dominikanski samostan na Ptuj*, Monografije CPA 10, Ljubljana.
- Mikl Curk, I. 1997, Gedanken zur "Legionskeramik" am Beispiel Poetovio, *RCRF Acta* 35, 51-54.
- Schindler Kaudelka, E., Janežič, M. 2019, The Pottery Finds from Excavations in Vičava in Roman Poetovio (Slovenia), in: *Ager Aguntinus* 3, Auer, M. (ed.), Wiesbaden. 115-130

ELECTRONIC SOURCES

<https://www2.rgzm.de/Transformation/Magyarország/Glanztongewerbe/GlanztongewerbeEnglisch.htm> (November 21st 2020).

SAŽETAK

FINO POSUĐE PETOVIJSKE PROIZVODNJE: KRATKI SAŽETAK

Ključne riječi: Poetovio, Vičava, Rabelčja vas, posuđe, Pannonische Glanztonware

Predstavljamo vam kratki uvod kako bismo naveli što već znamo o panonskoj keramici s premazom petovijske proizvodnje iz zapadne nekropole. Dodat ćemo nova otkrića o finom stolnom posuđu lokalne proizvodnje s četiri različita mjesta iskopavanja u gradskom području Ptuja: Vičava i Rabelčja vas.

PANNONIAN SLIPPED WARE IN *SIRMIUM*

More than 60 years of systematic archaeological excavations in Sremska Mitrovica yielded a huge amount of pottery material. Pottery from Sirmium was systematically presented in Brukner's work from 1981. Today in the Museum of Srem we have only working typology of pottery found in Sirmium, consisting of whole or fragmented vessels to show what pottery was used here. This typology of Sirmium was formed in 1970 by Ana Premk. Only lately, pottery, now called Pannonian slipped ware came into the focus of pottery researchers bringing a specific form of bowls, plates, drinking vessels, jugs, and one inkwell covered in glossy or matte slip. There is at this phase of research, 28 forms exist. This pottery group raises many questions in terms of where the centres of production were..

Key words: Roman pottery, Pannonian slipped ware, Sirmium, glossy or matte slip.

INTRODUCTION

This work will present initial research results of Pannonian slipped ware (PSW) in Sirmium. Pannonian slipped ware was produced in the whole Pannonia as a very popular vessel ware and was distributed to other parts of the Empire, like Moesia and Noricum. Workshops produced fine Plateware like bowls, plates, jugs, pots, drinking vessels and in Sirmium, we have one inkwell. The main characteristic of this ware is that forms follow the tradition of terra sigillata forms (sort of imitating) and introduce some new forms (Adler-Wölfel 2004: 89). Colours of slip can vary from red, red-brown, orange, grey and rarely black on vessels that can be produced in reduced or oxidised conditions. Slip can be burnished (glossy) or matte. Sometimes there is decoration, which can be made by rouletting or stamping (Dautova Ruševljan 1995/6; Adler-Wölfel 2004: 9; Nagy 2014; Nagy 2017: 6), or vessels can be decorated with grooves. This specific pottery was produced in many cities of Pannonia. *Sirmium* was one of the places of the local production, but it could happen that some pottery came from other towns in Pannonia through trade. At this stage of research it is difficult to find specifics of different production and separate vessels by the place of production, but some future analyses can provide better understanding of this problem. It is also difficult to find difference between local terra sigillata production and PSW.

SOME REMARKS ON THE HISTORY OF SIRMIUM

Sirmium was a very important and highly developed Roman city in *Pannonia* (figure 1), situated on the left bank of the river Sava. However, *Sirmium's* history¹ starts a long time before Roman conquest, in the neolithic times of Starčevo culture some 7 000 years ago. Romans came to this part of Pannonia around 74 before the new age. Still, *Sirmium*, at this time settlement of Pannonian and Celtic inhabitants, was probably taken in one of two conquests of the Pannonian plane. When the province of Pannonia was established, *Sirmium* became a part of it and quickly, after bringing Italic settlers, gained a status of a colony - *Colonia Flavia Sirmiensis* during the reign of the Flavian dynasty. The second century in *Sirmium* is marked by the famous emperor Marcus Aurelius. There are some indications that he could have died there in 180 A.D. Third century, a very troublesome time for the whole Roman Empire, was for *Sirmium* actually beginning of the

1 Detailed account on history and archeology of *Sirmium* can be studied at Mirković 1971, 5-94; Mirković 2009; Mirković 2017; in ed: *Sirmium* no I, II, III, IV, VIII, XI, XII; Милошевић 2001; Werner 2010; Jeremić 2016; all with additional bibliography on *Sirmium*.

imperial life. There are at least three warrior emperors born in *Sirmium* and its vicinity at that time. The end of 3rd and the first half of the fourth century were for *Sirmium* time of great development under imperial rule. It was a time when they also started producing locally very specific

glazed pottery. The fifth and sixth centuries are marked by very difficult times when the foederati were given the right to rule the city, first the Eastern Goths (Ostrogoths), then the Gepids. With the Avaric conquest in 582. the city practically ceased to exist.

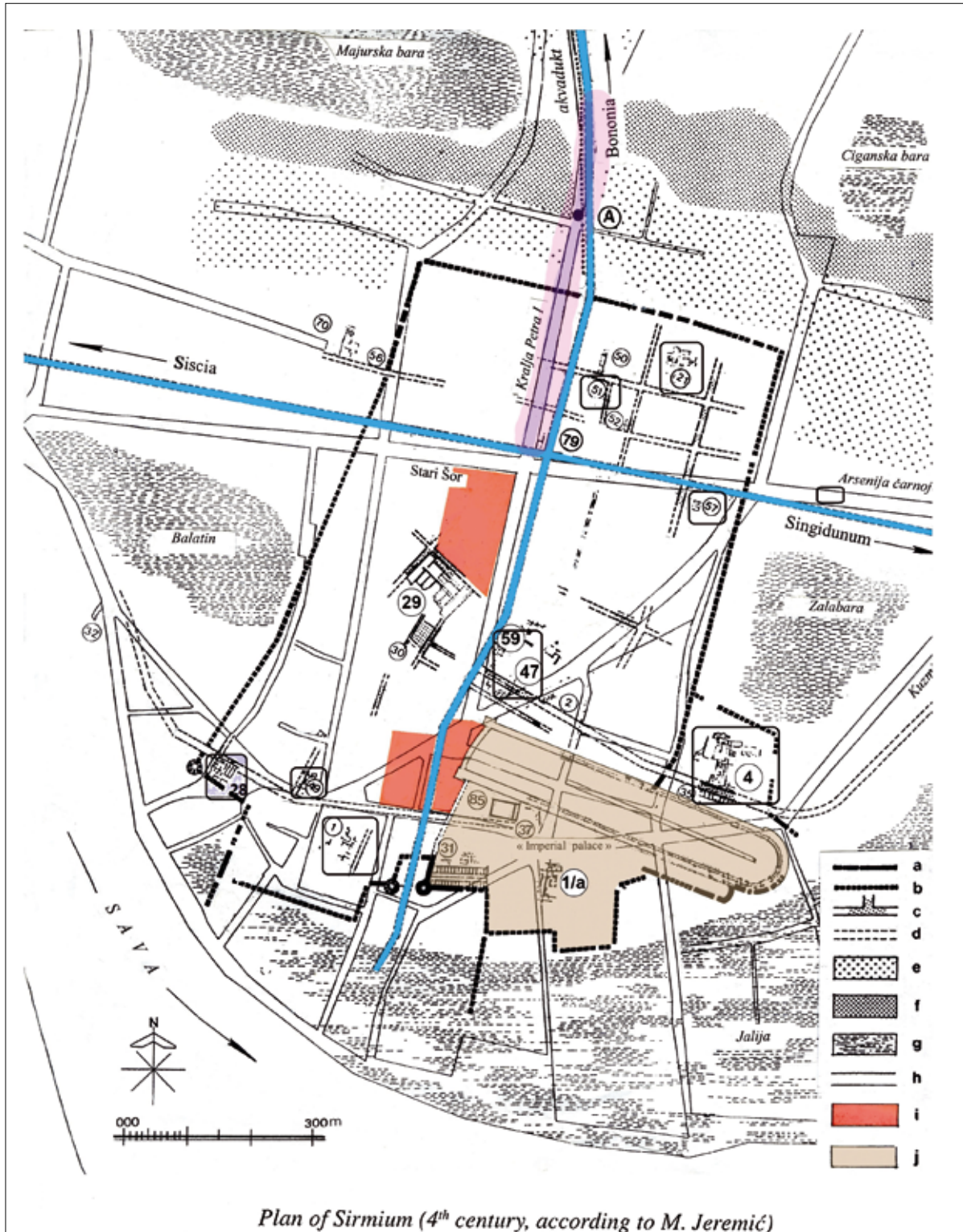

Fig. 1 Plan of Sirmium (4th century according to M. Jeremić)

ON THE RESEARCH OF THE POTTERY IN *SIRMIUM*

This six century-long history of Roman *Sirmium* left an abundance of ceramic material. Interest in research of *Sirmium* existed a long time before archaeologists started with systematic archaeological excavations in 1957 after the chance discovery of the part of the Imperial Palace. Up till now, there are 85 numbered sites and at least ten more done without numeration[1].² The sheer number of pottery fragments on each excavation (usually counts tens of thousands in number) gives a picture of a city with huge pottery production, some import and continuation of local production, especially of the Celtic tribes and local indigenous people; there was also some material connected with Ostrogoths and Gepides' stay in the city. This plethora of material is difficult to be shown in one short paper (not even count), so for this one, only examples from *Sirmium's* typology were analysed and presented.

Provisional pottery analyses of *Sirmium* material (and from other nearby excavated sites) are only done during excavations. Detailed analyses of the pottery was conducted in the publication of Olga Brukner from 1981.³ Some pottery finds from the site 4 (*villa suburbana*) were published by Maja Parović Pešikan in the edition *Sirmium* numbers II (1971) and III (1973). Pottery finds from the Roman period from the site in Mačvanska Mitrovica were published also in edition *Sirmium* number XII (1980). Ana Premk published an exceptional find of a pottery kiln from site 54 of *Sirmium* (Premk 1987: 437-450). Brukner also had work on new finds attributed to workshop 'X' (Brukner 1992: 373-379) and Dautova Ruševljan did work on stamped pottery from Srem (Dautova Ruševljan 1995/6: 53-72). Jasmina Davidović published terra sigillata finds from site 70 of *Sirmium* (Davidović 2009a: 65-93) and also a catalogue for the exhibition *Pottery in Sirmium - Restored pieces of pottery from the Museum of Srem* (Davidović 2009b). Ivana Popović published Premk's analyses of the pottery from the site 31 of *Sirmium* in her article in Zbornik Narodnog muzeja u Beogradu (Popović 2011: 335-372).

ANALYSES OF PANNONIAN SLIPPED WARE IN *SIRMIUM*

The Pannonian slipped ware in *Sirmium* studied here is presented only through types put in the working pottery typology of *Sirmium*. Therefore, all fragments of vessels have numbers used

for them in the working typology that Mr A. Premk, starting from 1970. We do not have a place of finding for some of them, so the location of finding is presented here only when it is known.

To clarify some aspects of Pannonian slipped ware (PSW) *Sirmium's* examples are grouped in two categories, based on the recognition of the Form as being the imitation of terra sigillata vessels or not.

THE PSW IN THE FORMS OF RECOGNISED TERRA SIGILLATA VESSELS

In *Sirmium*, among a huge pottery material, 11 terra sigillata forms are identified as being used as the most popular models for local production of the PSW. There are ten bowls and three plate PSW forms, and they are presented in Table 1.

Terra sigillata form	PSW Type	Decoration
Drag. 37	I/76	Notches
Drag. 40	I/25; I/104; I/105	
Ritt. 9	I/35	
Ritt. 5	I/65	
Drag. 44	I/42	
Drag. 35	I/43	
Drag.33/46	I/44	
Drag. 33	I/77	
Drag. 32	III/3	
Drag. 36 /Consp 39	III/13	Stamped leaves
Drag.36/Consp 40	III/7	Grooves

Table 1 The PSW in the forms of recognised terra sigillata vessels (made by J. Davidović)

2 Not numbered protective excavations were done by the Institute for protection of cultural monuments in Sremska Mitrovica. They did not continue the numbering of the sites in Sremska Mitrovica.

3 Brukner, O. Rimska keramika u jugoslovenskom delu provincije Donje Panonije, Beograd 1981.

1. A hemispherical bowl type I/76 (Plate 1; figure 1a and 1b) (Brukner 1981: 37,38, bowl type 3, T.70 – dated into 2nd and 3rd century) was made in the imitation of the Drag. 37. The outside surface of the bowl is covered in orange or reddish-brown glossy slip, sometimes black. Often is decorated beneath the rim with grooves or stripes with notches. One of the popular forms in *Sirmium*. This type of bowl was found in numerous variants in Carnuntum (Adler-Wölfl 2004: 44), in numerous sites in Hungary (Nagy 2014), in *Siscia* (Miletić Čakširan 2019: prilog 24, p. Z. Tip 7), *Mursa* (Leleković 2018: 6/17,18), in *Cibalae* (Ožanić Roguljić 2016; 41, Z 5), then also in Dalmatia is recognised as PSW type 1 (Ožanić Roguljić, Konestra 2017: 454. fig. 2) and there are examples found in *Singidunum* (Nikolić-Đorđević 2000: 32, bowl type I/33). In *Sirmium*'s typology, there are at least three variants of a vessel very close to terra sigillata from Drag. 40.

2. Type I/25 (Plate 1; Figure 2a and b) is a hemispherical bowl with orange or orange-red slip or grey or black slip that peels off.

3. Type I/104 is a bowl (Plate 1; Figure 3a and b) with orange glossy good quality slip on the inside, while the outside slip is present on the rim forward to the ending of a band of notches in the middle of a vessel. It is published by Brukner as bowl type 26. (1981: T.76/88-95) and dated in the 2nd and 3rd century A.D. This Form is similar to finds from *Carnuntum* (Adler-Wölfl 2004: 40) and *Cibalae* (Ožanić Roguljić 2016). Form of type I/104 can also be found in *Singidunum* (Nikolić-Đorđević 2000: 33, bowl type I/37).

4. Type I/105 (Plate 2; Figure 4a and b) probably also represents imitation of Drag. 40 form. It is a small bowl with the flaky matte slip of orange-red colour. This vessel is also similar to the find from Dalmatia, identified as PSW type 2 (Ožanić Roguljić, Konestra 2017: 456. fig. 2).

5. A small bowl-type I/35 (Plate 2; Figure 5 a and b) (Brukner 1981: 88, bowl type 8, T.72/44) made in the imitation of the form of Ritt. 9 with orange-brown glossy slip on the outer surface, which flakes. This example was found at the site Nova Ciglana of *Sirmium* (well-graves at the New brick plant - A/779), which is dated into the first to the end of the second century. Similar bowls appear in *Carnuntum* (Adler-Wölfl 2004: 38, kat. 40) and in *Singidunum* (Nikolić-Đorđević 2000: 55,56, bowl type I/102).

6. A hemispherical bowl type I/65 (Plate 2; Figure 6a and b) (Brukner 1981: 89, a bowl of type 7, T. 72 / 42,43- dated to the 1st - 2nd century) made in imitation of terra sigillata form Ritt. 5 with the orange glossy slip of good quality. This example was found at the site 50-51 of *Sirmium*.

7. A large, deep bowl type I/42 (Plate 2; Figure 7a and b) (Brukner 1981: 89, bowl type 11, T.73 / 47-55 – dated into the second half of the first century until the end of 3rd century) was made in the imitation of the Drag. 44 and covered in orange-red and sometimes black, glossy or matte slip. It is a frequent find in *Sirmium*. Similar type can be found in *Carnuntum* (Adler-Wölfl 2004: 45-47), in *Cibalae* (Ožanić Roguljić 2016: 41) and *Singidunum* (Nikolić-Đorđević 2000: 18, bowl type I/3).

8. A small hemispherical bowl type I/43 (Plate 2; Figure 8a and b) (Brukner 1981: 88, bowl type 6, T. 72 / 28-41- dated into the 2nd century) was made in the imitation of the Drag. 35. These bowls can have a glossy orange, red, grey or black slip. Fragments of this type were found in Nova Ciglana (A/793, A/1261) and other sites. Similar forms appear in *Carnuntum* (Adler-Wölfl 2004: 38) in *Mursa* (Leleković 2018: 5/1,2,3, 6/4), in *Cibalae* (Ožanić Roguljić 2016: 39, Z 3) and in *Singidunum* (Nikolić-Đorđević 2000: 28-29, bowl type I/26).

9. A deeper bowl type I/44 (Plate 3; Figure 9a and b) (Brukner 1981: 96, bowl type 79, T.90/123,124- dated into second and third centuries) was made as the imitation of the Drag. 33/46. Outside of the bowl is covered in orange, sometimes red or brown slip that can be glossy or matte. This type also appears in *Singidunum* (Nikolić-Đorđević 2000: 56, bowl type I/103).

10. A small conical bowl type I/77 (Plate 3; Figure 10a and b) (Brukner 1981: 90, bowl type I/20, T.74/70.71) was made in the imitation of the Drag. 33 and has a red and orange glossy or matte slip. Often occurs in layers from the second half

of the second century to the mid-third century being one of the favorite forms with finds from many sites of *Sirmium* and surrounding area. Similar form can be found in in *Mursa* (Leleković 2018: 6/12,13,14) and *Singidunum* (Nikolić-Đorđević 2000: 34, bowl type I/39).

11. A shallow plate with a ring-shaped narrowed base type III/3 (Plate 3; Figure 11a and b) (Brukner 1981: 88, plate type 14, T.71/18, 20-23 - Sector VI, trench 153 (A/1971)-dated to the second and third centuries) was made in imitation of terra sigillata form Drag. 32. Outside is covered with matte red or orange-red or glossy black slip. Similar forms can be found in *Cibalae* (Ožanić Roguljić 2016: 39, Z 2), and in *Singidunum* (Nikolić-Đorđević 2000: 96, plate type III/3).

12. A shallow plate type III/13 (Plate 3; Figure 12a and b) (Brukner 1981: 86, plate 4a, T66 / 18-20, T67 / 27-35- Sector VI, site 49) was made in imitation terra sigillata form Drag. 36/Consp. 39 (Ettlinger et al 1990). The rim can be decorated with ornaments of small incisions and the inner surface (base) with stamped floral decorations (here circle of leaves). This is a very favourite form found throughout *Sirmium*. The specimens date from the end of the first to the middle of the second century. Similar plates appear in *Carnuntum* (Adler-Wöfl 2004: 33, kat. 1), in *Siscia* (Miletić Čakširan 2019: 136, Prilog 22 / panonski T.Tip 1), *Mursa* (Leleković 2018: 6/5,6) and in *Singidunum* (Nikolić-Đorđević 2000: 99, plate III / 9).

13. A shallow plate type III/7 (Plate 4; Figure 13a and b) (Brukner 1981: 86, plate type 5, T.66 / 21-23, 26) is made in imitation of Drag. 36/51/Consp. 40 (Ettlinger et al. 1990) of the wide horizontally arched or slightly oblique rim with fluting, short oblique body and flat base. A plate is covered in a red glossy slip of good quality. Similar plates were found in *Carnuntum* (Adler-Wöfl 2004: 35, kat. 26) and in *Singidunum* (Nikolić-Đorđević 2000: 100, plate III/13).

PSW FORMS FOR WHICH IT IS HARD TO DETERMINE A PROTOTYPE

In *Sirmium*, a certain number of PSW vessels cannot be defined as the imitations of the terra sigillata forms. All forms are with the slip of red, orange, brown-red or black colour and burnished (glossy) or matte. They make the second group of forms. The group consist of 15 forms, of which there is eight bowls, three plates, two drinking vessels, one jug with two hands and one inkwell.

Bowls

14. A hemispherical bowl of a bevelled rim type I/22 (Plate 4; Figure 14a and b) (Brukner 1981: 97, type 84 bowl, T.92/146-147 - dated into the second and third centuries) one with orange glossy slip on the outside of good quality slip and the other with black burnished slip from the unknown site of *Sirmium*. This form also appears in *Singidunum* (Nikolić-Đorđević 2000: 48, a bowl of type I/78).

15. A biconical bowl type I/45 (Plate 4; Figure 15a and b) (Brukner 1981: 93, type 54 bowl, T.80 / 36,37- dated to the second and middle of the third century) with wide exterior ribbon-shaped edges decorated with grooves. The outer surface is covered with an orange glossy slip of good quality. There is one sample with a dark brown matte slip. Fragments of this type were found at sites 47 and 56 of *the Sirmium*. They are similar to 'S' profile forms of La Tène origin can be found at *Cibalae* (Ožanić-Roguljić 2016: 43, Z 12).

16. A large, deep biconical bowl type I/57 (Plate 4; Figure 16a and b) (Brukner 1981: 95, bowl tip 70, T.87/96-99- dated into the second and third centuries) covered with red-brown glossy slip. The example is found at site 45. Similar form is present also in *Singidunum* (Nikolić-Đorđević 2000: 65, zdela tip I/132).

17. A small conical bowl with flat base type I/74 (Plate 4; Figure 17a and b) (Brukner 1981: 85, plate type 1, T.65 / 2 - site 31 - dated to the second and third centuries) with a partially glossy outer surface. The bowl represents a variant of plate type III/4.

18. A hemispherical bowl I/60 (Plate 5; Figure 18a and b) with brown-red or orange glossy or matte slip. Below the rim, there are parallel grooves. This example found at site 42 of *Sirmium*. Similar form can be found at *Carnuntum* (Adler-Wöfl 2004: 42, kat.106) and *Singidunum* (Bojović 1977:Taf. 11,129).

19. A biconical bowl type I/63 (Plate 5; Figure 19a and b) (Brukner 1981: 97, bowl type 83, T.92 / 143-149 - site 44- dated into the end of the 1st, second century) covered on the outside with brown-reddish or orange glossy or matte slip. A similar type exists in *Singidunum* (Nikolić-Đorđević 2000, 38, bowl type I/47).

20. A smaller biconical bowl type I/97 (Plate 5; Figure 20a and b), similar to a bowl-type 74 in Brukner's typology (Brukner 1981: 95, bowl type 74, T.88 / 104,106,107 - dated into the end of the second and third centuries) has the orange glossy slip of very good quality.

21. A large, wide hemispherical bowl type I/84 (Plate 5; Figure 21a and b) of horizontally open rim covered in dark red or orange-red glossy and rarely a black matte slip. Fragments of this type were found at sites 56 and 31 of *Sirmium*. Similar forms are known in *Singidunum* (Nikolić-Đorđević 2000: 38, bowl type I/48).

Plates

The most popular plate in *Sirmium* was in our typology, put in two different types (III/4 and III/8), although they both represent a local variants of the so-called Pompeian plate.

22. A shallow plate type III/4 (Plate 5; Figure 22a and b) (Brukner 1981: 86, plate type 3, T.65/12-17-site 45, 49, 51, 53) of a ring-shaped profile of a conical or oblique body with a flat base. These plates have an orange-red, red or grey slip, glossy or matte, sometimes on both surfaces and sometimes only inside and on the rim. The same form can be found in *Singidunum* (Nikolić-Đorđević 2000: 112, plate III/43).

23. A plate type III/8 (Plate 6; Figure 23a and b) is similar but without a ring-shaped rim (Brukner 1981: 85, plate type 1, T.65 / 1,2,6-11 - new brick plant (A/ 326 and site 54) and with orange, red or reddish-slip, glossy or matte done in a similar manner as on the previous plate. Same form can be found in *Singidunum* (Nikolić-Đorđević 2000: 98-99, plate III/ 8). Both types were found at the majority of Roman sites (more information on that you can check in the work of Ožanić Roguljić 2016:49 with all literature). Both plate types were massively produced with different quality of the slip, mostly cracks and flaking occurs; only exceptional examples are of a good, firm, glossy quality of slip.

24. A shallow plate type III/25 (Plate 6; Figure 24a and b) of large dimensions, with a bevelled fluted rim, slightly concave walls and concave base with red-orange matte slip. Similar examples were found in *Carnuntum* (Adler-Wölfl 2004: 35, kat. 29,30), also in *Cibalae* and dated into the 2nd and 3rd century (Brukner 1981, plate type 9, T. 68/42-44) and *Singidunum* (Nikolić-Đorđević 2000: 114, plate III/50).

Drinking vessels

25. Drinking vessel type IX/6 (Plate 6; Figure 25a and b) of prolonged spindle body and concave base with orange glossy slip. Decorated with horizontal grooves from the rim. Found at the site 59 of *Sirmium*. Similar forms present in *Siscia* (Miletić Čakširan 2019: prilog 21, panon. Č. Tip 1) and *Singidunum* (Nikolić-Đorđević 2000: 174, pehar tip IX/45).

26. Drinking vessel type IX/11 (Plate 6; Figure 26a and b) (Brukner 1981: 77, beaker type 18, T.52/27- dated into 3rd century) of the cylindrical body and flat base with orange glossy slip. It is decorated in the upper part with the intermittent stamped pattern of eights and sticks. Found at Nova Ciglana (New brick factory-A/1354).

27. Jug with two hands type VII/39 (Plate 7; Figure 27a and b) (Brukner 1981: T. 52/25- site 31) of the flat, slightly bevelled fluted rim, the cylindrical neck that breaks into a pear-shaped body. The red-orange glossy slip is of good quality but flaky and with cracks at some parts. The neck is decorated with an intermittently placed stamped pattern of eights and sticks.

Inkwell

28. In *Sirmium's* material, there is also important to present an inkwell⁴ type XV/1 (Plate 7; Figure 28a and b) (Brukner 1981: 112, mastionica tip 1, T. 132/6) of cylindrical form with the concave upper part and circle perforation in the centre, and smaller ones on the rim for the stilus. The outside surface is covered in a flaky matte red slip.

4 Unfortunately, this example was stolen in 1995 from the permanent archaeological exhibition at the Museum of Srem.

CONCLUSION

This is the first report on PSW in *Sirmium*. It clearly shows a variety of forms; some of them follow the tradition of the production of terra sigillata forms similar to many other Roman sites in Pannonia. However, there are some new forms for which we need to find a place of production. Detailed future analyses of all fragments found in *the Sirmium* and identified as PSW will probably answer that. Some of the forms published by Brukner in 1981 are not available in the museum at present. Finding and re-analysing these fragments is also one of the goals in the future.

BIBLIOGRAPHY

- Adler-Wolff, K. 2004, *Pannonische Glanztonware aus dem Auxiliarkastell von Carnuntum, Ausgrabungen der Jahre 1977-1988*, Wien.
- Bojović, D. 1977, *Rimska keramika Singidunuma*, Beograd.
- Brukner, O. 1981, *Rimska keramika u jugoslovenskom delu provincije Donje Panonije*, Beograd.
- Брукнер, О. 1992, Нови налази имитације тере сигилате панонске радионице 'X', Зборник Народног музеја XIV-1, Београд, 373-379.
- Давидовић, Ј. 2009а. Тера сигилата са локалитета 70 Сирмијума (Бенефицијарна станица), Зборник Музеја Срема 8, Сремска Митровица, 65-93.
- Давидовић, Ј. 2009б. Керамика Сирмијума, реконструисани експонати Музеја Срема, Сремска Митровица.
- Dautova Ruševljan, V. 1995/1996, Prilog proučavanju rimske keramike sa pečatnim ornamentima iz Srema, *Rad Muzeja Vojvodine* 37-38, Novi Sad, 53-72.
- Ercegovic-Pavlovic, S. 1980, Les necropoles romaines et medievals de Mačvanska Mitrovica, *Sirmium XII*, Beograd.
- Ettlinger et al, 1990, *Conspectus formarum terrae sigillatae Italico modo confectae*, Materialien zur Romisch-Germanischen keramik, heft 10, Bonn.
- Jeremić, M. 2016, *Sirmium - grad na vodi*, Beograd.
- Leleković, T. 2018, How were Imitations of Samian Formed?. *Internet Archaeology*, 50 (1), 18, 20 doi:10.11141/ia.50.18.
- Miletić, Čaksiran, I. 2019, *Tipološko hronološka klasifikacija rimske keramike iz Siscije*, Zagreb, doktorska disertacija.
- Милошевић, П. 2001, *Археологија и историја Сирмијума*, Нови Сад.
- Mirković, M. 1971. Sirmium – its history from the first century AD to 582 AD, *Sirmium I*, Beograd, 5-90.
- Mirković, M. 2009. *Sirmium – istorija rimskog grada od I do VI veka*, Sremska Mitrovica.
- Mirković, M. 2017. *Sirmium – its history from the first century AD to 582 AD*, Novi Sad-Sremska Mitrovica.
- Nagy, A. 2014, Forging Samian Ware in the Pannonian way: The case of Stamped Pottery. Poster for the 28th Congress of the RCRF, Catania, Italy 23-30 September 2012, 119-127.
- Nagy, A. 2017, *Resatus and the stamped pottery*, Aquincum studies 1, Budapest.
- Nikolić-Dorđević, S. 2000, Antička keramika Singidunuma, oblici posuda, *Singidunum 2*, Beograd, 11-244.
- Ožanić Roguljić, I., Konestra. A. 2017, Pannonian slipped ware in Dalmatia, *Zbornik III. Međunarodnog arheološkog kolokvija*, Crikvenica, 453-460.
- Ožanić Roguljić, I. 2016, *Tipologija rimske keramike iz Vinkovaca*, Monographiae Instituti archaeologici 10, Zagreb.
- Поповић, И. 2011, Налази из економског објекта А (локалитет 31) у склопу палатијалног комплекса Сирмијума, Зборник Народног музеја 20/1, Београд, 335-372.
- Parović-Pešikan, M. 1971, Excavations of a Late Roman Villa at Sirmium, *Sirmium II*, Beograd, 15-50.
- Parovic-Peshikan, M. 1973, Excavations of a Late Roman Villa at Sirmium, *Sirmium III*, Beograd, 1-44.
- Premk, A. 1987, Production of Early Roman Pottery in Sirmium, *RFCR Acta XXV / XXVI*, 437-450.
- Werner, M. 2010, *Sirmium, Imperial palace complex*, Sremska Mitrovica.

SAŽETAK

PANONSKA KERAMIKA S PREMAZOM U SIRMIJU

Ključne riječi: Rimska keramika, panonska klizava posuda, sirmijska, sjajan ili mat slip

Više od 60 godina sustavnih arheoloških istraživanja u Srijemskoj Mitrovici dalo je ogromnu količinu keramičkog materijala. Keramika iz Sirmija sustavno je predstavljena u radu O. Brukner iz 1981. Danas u Muzeju Srema imamo samo radnu tipologiju keramike pronađene u Sirmiju, koja se sastoji od cijelih ili fragmentiranih posuda koje pokazuju kakva je keramika korištena. Tipologiju Sirmija 1970. godine formirala je Ana Premk. Tek u posljednje vrijeme u fokus istraživača dolazi keramika koja se danas naziva panonskom keramikom s premazom, iznijevši na svjetlo specifičan oblik zdjela, tanjura, posuda za piće, vrčeva i jedne tintarnice koji su bili prekriveni sjajnim ili mat premazom. U ovoj fazi istraživanja postoji dvadeset i osam postojećih oblika. Ova skupina keramike postavlja mnoga pitanja u smislu gdje su bili centri proizvodnje.

Pl. 1

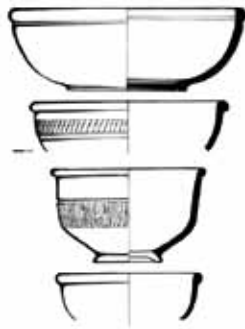

Figure 1a - Type I/76



1



2

Figure 1b - Type I/76

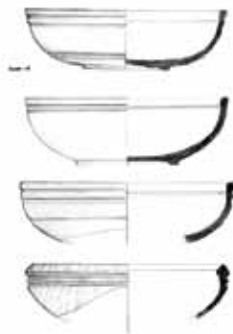

Figure 2a - type I/25



1



2



3



4

Figure 2 b - Type I 25



Figure 3a - type I/104



1

Figure 3b - type I/104

Plate 1 The PSW in the forms of recognised terra sigillata vessels, Type I/76, I/25, I/104 (Drawing and photo A. Premk; modified by IOR)



Figure 4a - type I/105



1

Figure 4b - type I/105



Figure 5a - type I/35



1

Figure 5b I/35



Figure 6a - type I/65



1

Figure 6b - type I/65



Figure 7a - type I/42



1

Figure 7b - type I/42



Figure 8a - type I/43



1



2

Figure 8b - type I/43

Pl. 3



Figure 9a - type I/44



Figure 9b - type I/44



Figure 10a - type I/77



1



2

Figure 10b - type I/77



Figure 11a - III/3



1



2

Figure 11b - III/3



Figure 12a - type III/13



1



2

Figure 12b - type III/13

Plate 3 The PSW in the forms of recognised terra sigillata vessels, Type I/44, I/77, III/3 (Drawing and photo A. Premk; modified by IOR)



Figure 13a - type III/7



Figure 13b - type III/7



Figure 14a - type I/22

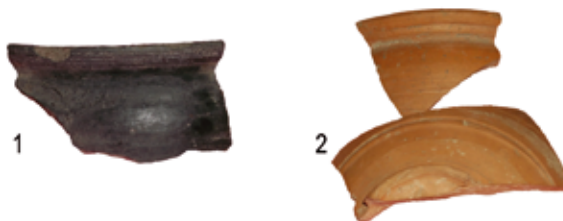

Figure 14b - type I/22



Figure 15a - type I/45



Figure 15b - type I/45



Figure 16a - type I/57



Figure 16b - type I/57



Figure 17a - type I/74



Figure 17b - type I/74

Plate 4 The PSW in the forms of recognised terra sigillata vessels, type III/7; PSW forms for which it is hard to determine a prototype, Type I/22, I/45, I/57, I/74 (Drawing and photo A. Premk; modified by IOR)

Pl. 5



Figure 18a – type I/60



1
Figure 18b - type I/60



Figure 19a – type I/63



1
Figure 19b – type I/63

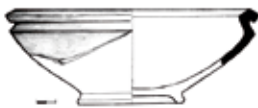

Figure 20a – type I/97



1
Figure 20b – type I/97



Figure 21a – type I/84



1
2
Figure 21b – type I/84



Figure 22a – type III/4



1
Figure 22b - type III/4

Plate 5 PSW forms for which it is hard to determine a prototype, Type I/60, I/63, I/97, I/84, III/4 (Drawing and photo A. Premk; modified by IOR)



Figure 23a – type III/8



1



2

Figure 23b – type III/8



Figure 24a – type III/25



1

Figure 24b – type III/25



Figure 25 – type IX/6

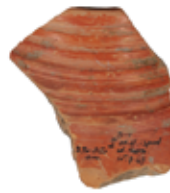

Figure 25b - type IX/6



Figure 26a - type IX/11



1

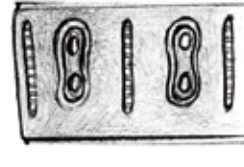

Figure 26b - type IX/11

Pl. 7

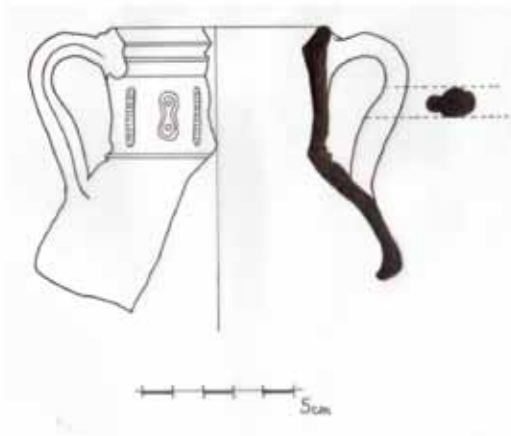

Figure 27a – type VII/39



Figure 27b -- type VII/39

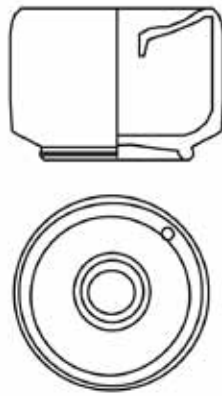

Figure 28a -type XV/1

POTTERY FROM VIMINACIUM – CHARACTERISTICS AND MULTIPURPOSE FUNCTION

Overview of the part of pottery vessels discovered at Viminacium is given in the article. Techniques of making and decorating as well as their multipurpose use are presented. The most common working technique in the treatment of outer surface of vessels are colouring, engraving and stamping. Most of the vessels are dated to the period from the beginning of the second to the end of the third century. Certain forms had a short expiration date, while some underwent several production making changes. These are locally produced vessels intended for everyday use. Among them, according to their decoration, vessels made after the luxury imported models stand out. The research of Viminacium confirmed the role of its pottery-brick production center, which, with its production and distribution, met the needs of both the city itself and the surrounding provinces.¹

Key words: Viminacium, craft center, slip, engraving, stamping, terra sigillata, relief decoration, antiquity.

The archaeological site of Viminacium is located next to the village of Kostolac, in the immediate vicinity of the conflux of the Mlava and Danube rivers. As the capital city of Upper Moesia, it used to be the largest craft center of this province. Among the wide variety of crafts, the most developed one was pottery. Besides the production of bricks, lamps, terracottas etc., the production of vessels was one of the most prolific trades.

One of the craft centers of Viminacium was discovered during the rescue excavations conducted on the area of its southern necropolises. The material obtained there made it possible to determine the shapes, functions and style of its product assortment, while chemical analyses provided the information about the composition of clay, clay pits and the distribution of end products.

The analysis of the ceramic material from the craft center and all the other researched locations showed a very diverse assortment of vessel shapes. The largest portion of locally produced vessels is thin-walled medium-coarse ware made on potter's wheel. The clay these vessels are made of is rich in iron minerals, so most of the vessels are fired red, if they were fired in oxidising atmosphere, or grey to black, if fired in reduction atmosphere. In most cases, their outer surface is slipped with a red coating which rubs off. (Plate 1)

The predominant shapes indicate that these were mostly vessels used in everyday life, for preparing, serving and consuming foods and drinks. (Plate 2: 1) There is also a large number of vessels used for storage or transport. Among the vessels imported to Viminacium, the most common ones are amphorae (Bjelajac 1996: 109-114), and then terra sigillata bowls (Bjelajac 1990: 190).

The vessels discovered in this craft center were mainly fired at temperatures between 850 and 1050 °C (Raičković 2012: 163). Each shape was made of the same clay body, but some specimens are of higher quality than the others. The vessels determined as jugs, produced specifically for the needs of the the necropolis, are of poorest quality.

¹ This paper was created as an activity of the project *Life on the Roman road: communications, trade and identities on Roman roads in Croatia from 1st – 8th CE* (UIP-05-2017-9768) funded by the Croatian Science Foundation.

More than 13500 graves with inhumation and cremation burials have been discovered on the area of the necropolis within which this craft center was found (Korać, Golubović 2009, 12). Most of these graves contained grave goods consisting of ceramic vessels, oil lamps and terracottas. Their number, as well as the specific position in which they were laid, vary among the individual graves. What is common to all of them is that in more than 95% of cases these pottery items were local products.

Besides the necropolis area, the existence of products of local workshops was also confirmed on all the other researched locations in the region of Viminacium, while a portion of its product assortment reached other settlements of the province of Upper Moesia, along the Iron Gate Limes, and was also distributed to the surrounding provinces of Pannonia and Dacia. Surprisingly, the quality of these vessels varies, depending on whether they were intended for the necropolis or discovered in the residential layers, although it is confirmed that they come from the same workshops.

Economic status and social trends can, to a degree, be traced through the ceramic materials. Some forms of vessels (bowls) are characterized by great differences in size and volume, as well as in the quality of clay that certain types are made of, while other forms (jugs) are completely uniform and do not differ across the Empire. The forms used over a long period of time gradually change their basic profilation (the neck of the jugs becomes shorter, or bodies of pots become more elongated). Comparing these local products to other, chronologically equivalent ones, we can notice great discrepancies. It does not have to indicate a change in ethnical terms, but rather in the material culture- that local population retained the details of the autochthonous material culture to a higher or lower degree.

Although the forms and types of vessels are well-known, and the pattern of concentration and distribution of certain product groups established, we should also pay attention to the petrological analyses to confirm the accuracy of current theses and analogies concerning the scope of distribution of this local workshop's products. The problem arises specifically in the case of vessels for everyday use, since the data concerning their style do not yield sufficient information, while, by their nature, they have a wide area of distribution. The proximity of the Danube made the transportation of this craft center's products to other cities much easier.

The most common type of outer surface treatment is simple slipping. (Plate 1) The vessels were mostly slipped in different tones of red paint, not very hard-wearing (since it rubs off).

Besides slipping, varnishing and painting on the inner and outer surface of the vessels, there are also various other types of ornaments. (Plate 2 & 3 : 1-14) The most common ones are grooves and incisions. Incision is most commonly used on cylindrical pots and jugs (Plate 2: 2, 3). This method of decoration probably originated from glass faceting. Incised letters on pots' bodies are the most common form of such decoration. Bowls, pots and jugs were more often decorated with grooves. Ribbed ornamentation is most frequent on the vessels made of sandy, kaolin clay, (Plate 2: 6-9) no matter the type (pots, bowls or jugs). When it comes to stamping, although this type of decoration appears on the vessels from south Pannonia from the end of the 1st to the middle of the 2nd century, this is not the case in Viminacium.

With the appearance of the imitation of terra sigillata vessels, craftsmen begin to apply stamping, besides relief decoration. The find of three smaller clay stamps, fired red, used for vessel decoration within the craft center also confirms this (Raičković 2007: T. XVII/11-13). This type of decoration dates back to pre-Roman traditions, while the technique itself, applied by the provincial craftsmen, reveals the tastes of the local population.

The major portion of stamped ceramics comes from the city and suburban area, from the area of the amphitheatre, thermae and the settlement located east of Viminacium. The rest of them are of funerary character. Among the vessels functioning as grave goods, the ones with stamped decoration are bowls and plates, found in equal proportion in cremation and inhumation burials.

Ornamentation was applied mostly on the outer surfaces of the vessels, except in the case of plates, where stamped decoration appears on the rims or the inner side of the recipient. The production of this type of vessels had two phases in Viminacium. The earlier variant appears during the 2nd century, while the later one encompasses the period from the second half of the 3rd to the middle of the 4th century (Bogdanović 2017: 268).

One of the characteristics is that this type of decoration is only used on luxury tableware. The craftsmen used different combination of stamps for ornamentation, so it is extremely difficult to find analogies. Not a single specimen of a signed stamped vessel has been discovered yet. The vessels belonging to the cultural horizons of the 2nd century are mostly medium-coarse ware, fired red and painted or varnished in red tones. The only exceptions are a few vessels which are fired grey and painted grey or black. These specimens also have polished surfaces, and are characterized by consistency in ornament organization- decoration is arranged in rows, with motifs which repeat or simply occupy the central part of the inner surface of the vessel. The favorite motif is leaf, stylized in different ways, then rosette, sickle motif, but also *planta pedis*. (Plate 5:21)

The earlier phase is characterized by vessel forms made by the example of the imported ones, made in terra sigillata technique and decorated with floral motifs. The characteristics of the later phase are the form of biconical vessels decorated with floral and geometrical motifs, while figural representations appear only in rare cases.

The bell-shaped form of vessels, the local variant of Drag. 29, is predominant in the earlier group. Across the middle part, and often also at the very bottom, they have a simple decoration in one row created by repetition of leaf motifs, (Plate 4) occasionally combined with rosettes. There are only one or two specimens of bowls made by the example of Drag. 35 and Drag. 37 in Viminacium (Bogdanović 2017: T. I-269, II-270, III-272); here, leaf motifs are at the bottom, or their repetition creates a lattice-like rhombuses and stylized egg-and-dart motifs on the outer surface of the vessel. Their analogies are found in Pannonia, among Pannonian grey ware with more elaborate stamped ornamentation, dated to the 2nd century. In Upper Moesia, analogies are found in Singidunum. In the product assortment of Viminacium's workshops, there are three bowl forms with stamped decoration. They all have planta pedis motif, but also leaf motifs, on the inner surface of the vessel, always together with a circular ornament made with a wheel cutter. They were most likely made by the example of Consp. 36 and Consp. 37 forms of Arretine ware (Bogdanović 2017: 270).

Pots with stamped decoration appear extremely infrequently. One of the most common pot forms from Viminacium has two or three handles, a cylindrical neck and ovoid body on a ring-shaped foot. They appear during a wide chronological span from the 2nd to the 4th century, with different profiles. This form of pots is often ornamented with various techniques, like painting, polishing, applications and engraving. One larger pot of this type was discovered and it had three handles and snake applications, (Plate 5:27) so it was classed as a cult vessel. They are considered to be products of Viminacium (Bogdanović 2017: 272). There is only one more stamped pot in Viminacium- a smaller two-handled one with a conical neck and round body. It is decorated with repeated heart-shaped motif across the middle of the body, and with no analogies. (Plate 5:28)

The earlier phase of stamped vessels is also represented with variants Drag. 17, 18 and 36 of local plates. The ornamentation in the form of stylized leaves and planta pedis motif appears on the vessels of all three types, and they are concentrated in the central part of the bottom of the plate. Analogies to these samples are found within Moesian, Pannonian and Dacian workshops, so it can be said that the plates belong to the popular imported forms, after which the local craftsmen made their products in the 2nd and 3rd century. The vessels belonging to the earlier group, from the cultural horizons of the 2nd century, are medium-coarse ware fired red. The surface of these vessels is most commonly painted or varnished in red tones.

The later phase of the vessels with stamped ornamentation is characterized by a smaller number of vessel forms, but much more diverse ornamentation. Besides floral ornaments, there are also geometrical ones, and occasionally even figural representations. The most common form is a biconical bowl. Among the imported forms, the most common one is Consp.33.1.2, the example after which local variants were made (Bogdanović 2017: T. V). The products of local craftsmen are characterized by biconical form and rich floral and geometrical ornamentation, arranged into several horizontal rows or medallions. Analogies have not been found. On the plates from this phase, ornamentation is placed along the rim of the vessel, by alternate repetition of two or more motifs.

The largest portion of the vessels of the later phase is dated to the 2nd half of the 3rd century. They are medium-coarse ware, fired grey or red, and with surfaces painted in red or grey tones.

The differences in quality between the earlier and later group are virtually non-existent, since workmanship was equally good for both. Except for the introduction of new forms, the motif repertoire is enriched, too; likewise, the arrangement of ornaments on the vessels is changed. Three types of motifs- floral, geometrical and figural, are combined, creating unique compositions, with no possibility to find their analogies.

The technique of stamping was accepted by the provincial craftsmen in a short time, so the continuity in production can be traced from the 2nd century, when local potters create the first specimens, all the way to the 2nd half of the 3rd or middle of the 4th century, when the production of stamped vessels ceases. Most likely, vessels with stamped ornaments were produced within the existing workshops. Production of relief and polished terra sigillata in Viminacium was happening along with the appearance of this type of ware in the 2nd century. The increased production of luxury ware diminished the significance of import, which resulted in the decrease in the inflow of vessels from large pottery centers.

The paper presents an overview of the shape, function and structure of ceramic vessels discovered during the decades-long archaeological excavations of Viminacium. These vessels are the product of a local pottery craft complex. The chemical and mineralogical characterization of the pottery production of this workshop suggests the presence of several groups of ceramic clays. Several basic clay masses are distinguished in relation to whether the final product

was intended for preparing food, its consuming, or ritual laying in the grave of an inhumated or cremated deceased. Mineralogical and chemical examinations were conducted over the raw materials and it was determined that besides this pottery craft center, there had to be another one in which was used the clay from the same loan. This conclusion follows the extensive analysis of the product range from this pottery complex, which is compared with the forms discovered on the necropolis itself and in the settlement stratum. Forms that do not appear in the pottery range of this center, but are discovered at necropolises or in settlement stratum with the same chemical index in clay mass, must have been the product of another workshop at Viminacium whose production went parallel with the first one. The specificity of the material of this workshop complex is reflected in the fact that craftsmen who have responded to the needs of pottery use in funerary rituals at the necropolises have made these products in poor quality compared to those distributed to the living part of the population.

BIBLIOGRAPHY / LITERATURA

- Bjelajac, Lj. 1990, *Terra sigillata u Gornjoj Meziji*, Beograd 1990.
- Bjelajac, Lj 1996, *Amfore gornjomezijskog Podunavlja*, Beograd 1996.
- Bogdanović, A. 2017, Keramičke posude sa pečatnim ornamentima iz Viminacijuma, *Zbornik Narodnog muzeja Beograd, XXIII/1*, Beograd 2017.
- Ettlinger, E. et al. 1990, *Conspectus formarum terra sigillatae Italico modo confectae*, *Materialien zur römisch-germanischen Keramik, Heft 10*, Bonn: Dr. Rudolf Habelt GmbH.
- Korać, M., Golubović, S. 2009, *Viminacium, Više grobalja 2*, Beograd 2009.
- Raičković, A. 2007, *Keramičke posude Zanatskog centra iz Viminacijuma*, Beogra 2007.
- Raičković, A. 2012, *Keramičke posude u grobovima tipa Mala Kopašnica Sase, doktorska disertacija*, Filozofski fakultet, Univerzitet u Beogradu 2012.

SAŽETAK

KERAMIKA IZ VIMINACIJA - KARAKTERISTIKE I VIŠENAMJENSKE FUNKCIJE

Ključne riječi: *Viminacium*, zanatski centar, premazivanje, urezivanje, pečatiranje, terra sigillata, reljefni ukras, antika.

U radu je dat pregled dijela keramičkih posuda otkrivenih na Viminaciju. Prikazane su tehnike izrade i ukrašavanja kao i njihova višenamjenska upotreba. Najčešća tehnika obrade vanjske površine posuda je premazivanje, urezivanje i pečatiranje. Najveći dio posuda datiran je u period od početka drugog do kraja trećeg stoljeća. Određene forme su imale kratak rok upotrebe, dok su neke pretrpjele više razvojnih promjena. Radi se o lokalno proizvedenim posudama namijenjenim svakodnevnoj upotrebi. Među njima svojom dekoracijom se ističu posude rađene po uzoru na luksuzne importne posude. Istraživanjem Viminacija je potvrđena uloga njegovog grnčarsko opekarskog centra koji je svojom proizvodnjom i distribucijom podmirivao potrebe kako samog grada tako i okolnih provincija.

Pl. 1

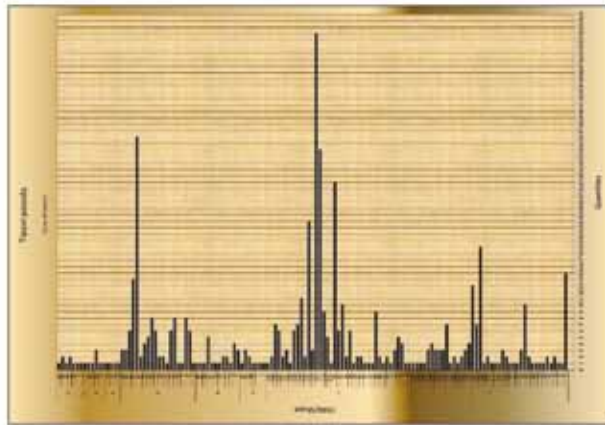

a

spoljna površina/ outer surface

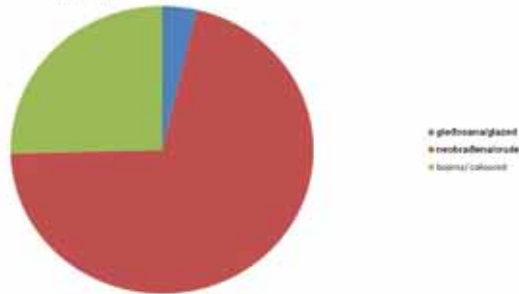

b

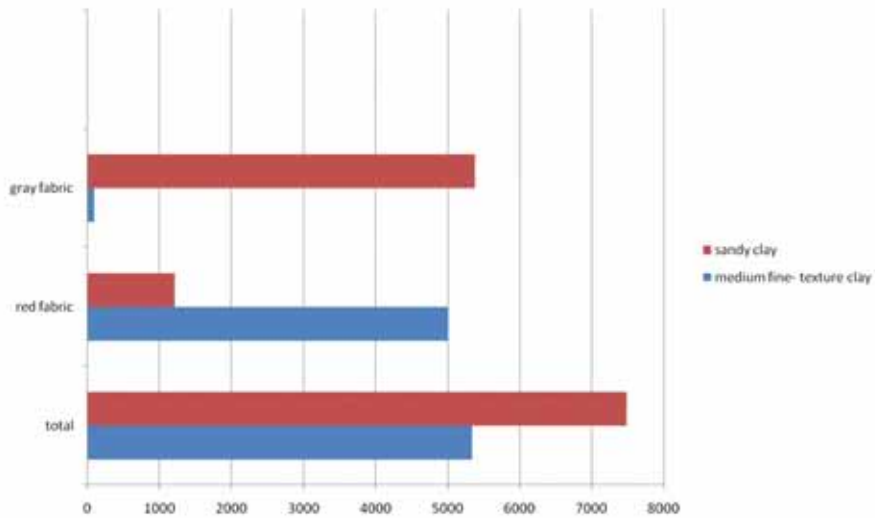

c

Plate 1. Pottery forms (a), outer surface (b), relationship between sandy and medium fine texture clay (c)

Pl. 2



1



2



3



4

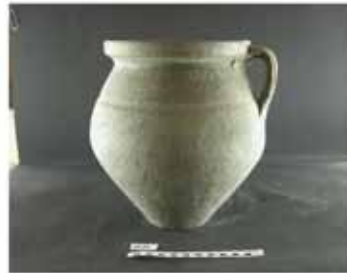

5



6



7



8



9

Plate 2. Predominant shapes of pottery

Pl. 3



10



11



12



13



14

Plate 3. Special decoration techniques

Pl. 4



15



18



16



19



17



20

Plate 4. Stamps

Pl. 5



21



22



23



24



25



26

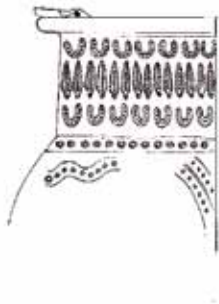

27

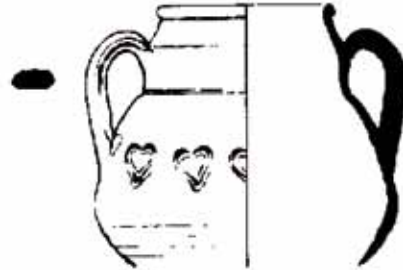

28

Plate 5. Stamps

STAMPED POTTERY IN *AQUINCUM*

The stamped ceramic finds of Aquincum were first systematically examined by Lajos Nagy. Since then, the gathering of the reference material is still in process. On the co-occurrence of different motifs, decorative styles and forms these stamped vessels could be assigned to larger groups.

Key words: Roman stamped pottery, Aquincum

The Aquincum Museum's collections contain thousands of stamped pottery fragments. These vessels differ from terra sigillata not only in terms of production techniques and, therefore, their plasticity. Although their style of rendering and motif patterns are similar, unlike the three-dimensional relief decoration of the terra sigillata, the stamped motifs are outlined, like characters in a comic book. Hence in some cases, the ornaments (especially the animal-shaped and stand-alone floral-geometric ornaments) also reflect the drawing skills and style of the local potters. The few motives which have been precisely adopted from terra sigillatas, from vessels produced in South Gaul (La Graufesenque, Banassac), but they were used individually and were taken out of context (**Fig. 1**). We can call these stamped vessels local ware, not necessarily imitations, as local potters' style is clearly observable; they can be easily distinguished from other pottery types of the Roman Empire. In most cases, motives can be accurately identified (**Fig. 2**). The vessels can be classified primarily according to the motifs, but for now, only those found together can be connected with the same workshop.

Besides the typical 'feet with sandals,' the first and only potter whose name appeared is Deuso (Nagy A. 2016). The spread of *planta pedis* stamped vessels from Lágymányos, the number of the finds and the context they came from implies that this type is to be dated to the end of the 1st century AD or at latest to the first decades of the 2nd century AD.

The Resatus-stamp vessels, the hundreds of connected motifs, as well as those which are very similar in style, belong to the most diverse group (Nagy A. 2017). Their most likely production site – along with that of one of the groups with *planta pedis* stamps – may have been the Lágymányos workshop, but the question has not been resolved yet on account of the variants with relief decorations.

The main conclusions of the earlier publication (Nagy A. 2017) on stamped pottery from *Aquincum* are the following:

1. The forms and decorations of the *pannonische Glanztonware* vessels from *Aquincum* are mostly not of Celtic origin. They exhibit North Italian and South Gaulish influence.
2. The same motifs can appear on the inside or the outside of the vessels. The same stamps appear both on grey and red coloured (even with the name stamp of Resatus), excellent quality and on very worn-out surfaces.
3. Resatus and his workshop did not only produce vessels with his name stamp and some leaf motifs. Hundreds of patterns can be associated with his group.

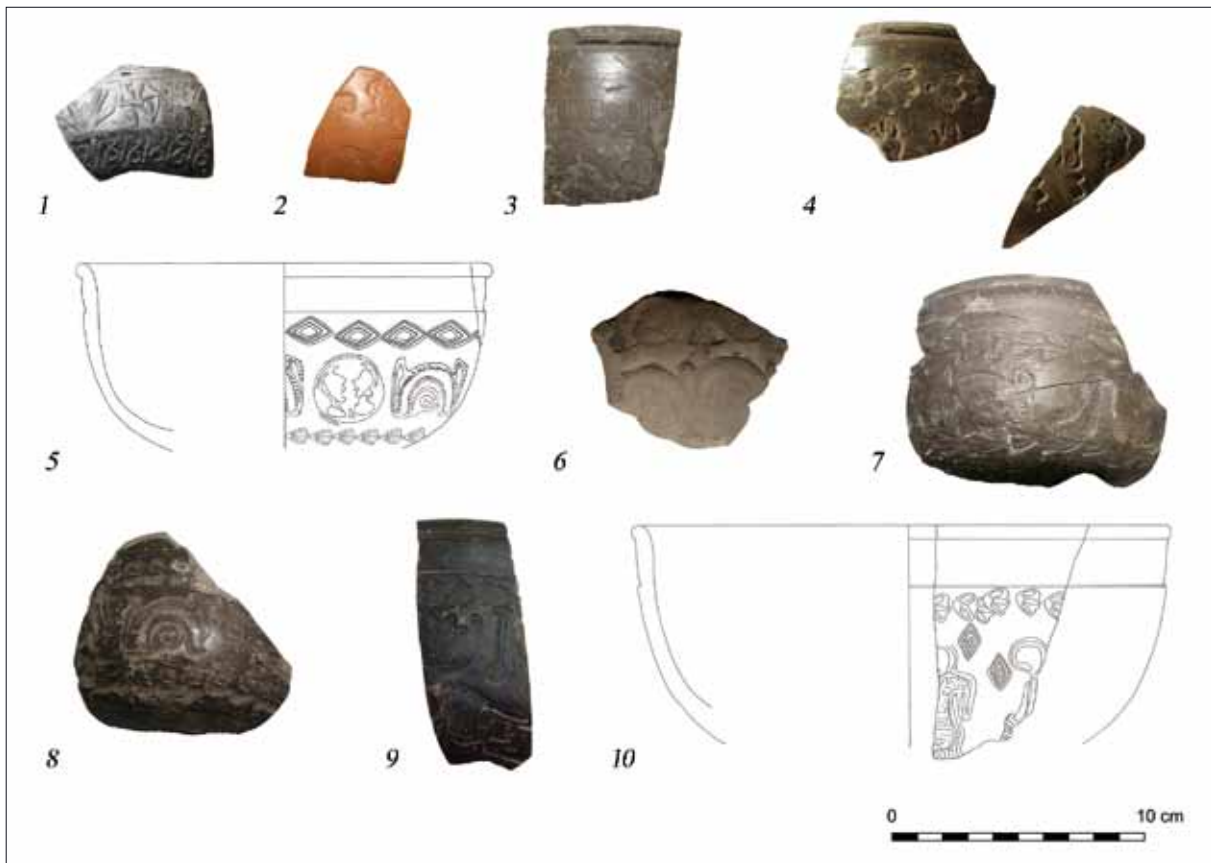

Fig. 1 Terra sigillata motifs on stamped vessels (A. Nagy)

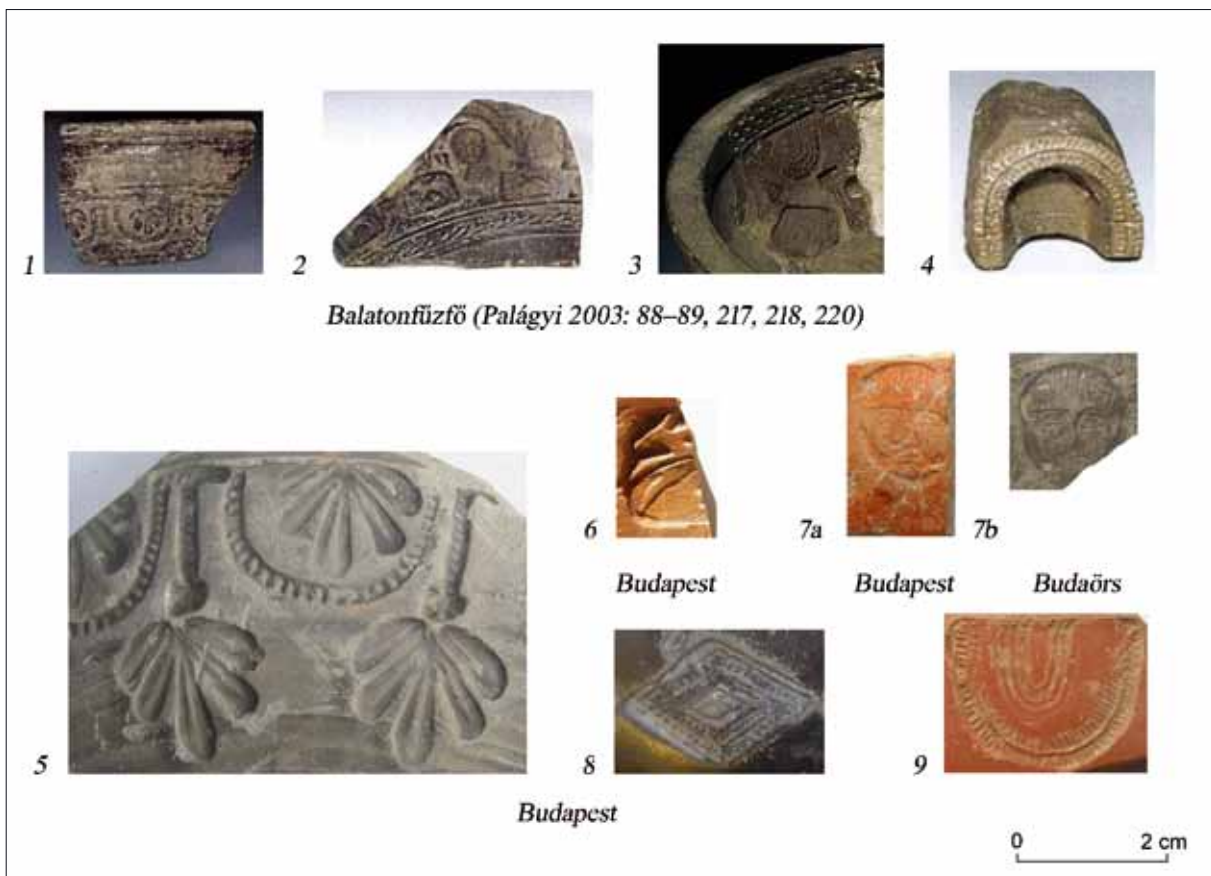

Fig. 2 Similarities between Balatonfűzfő and local motifs (A. Nagy)

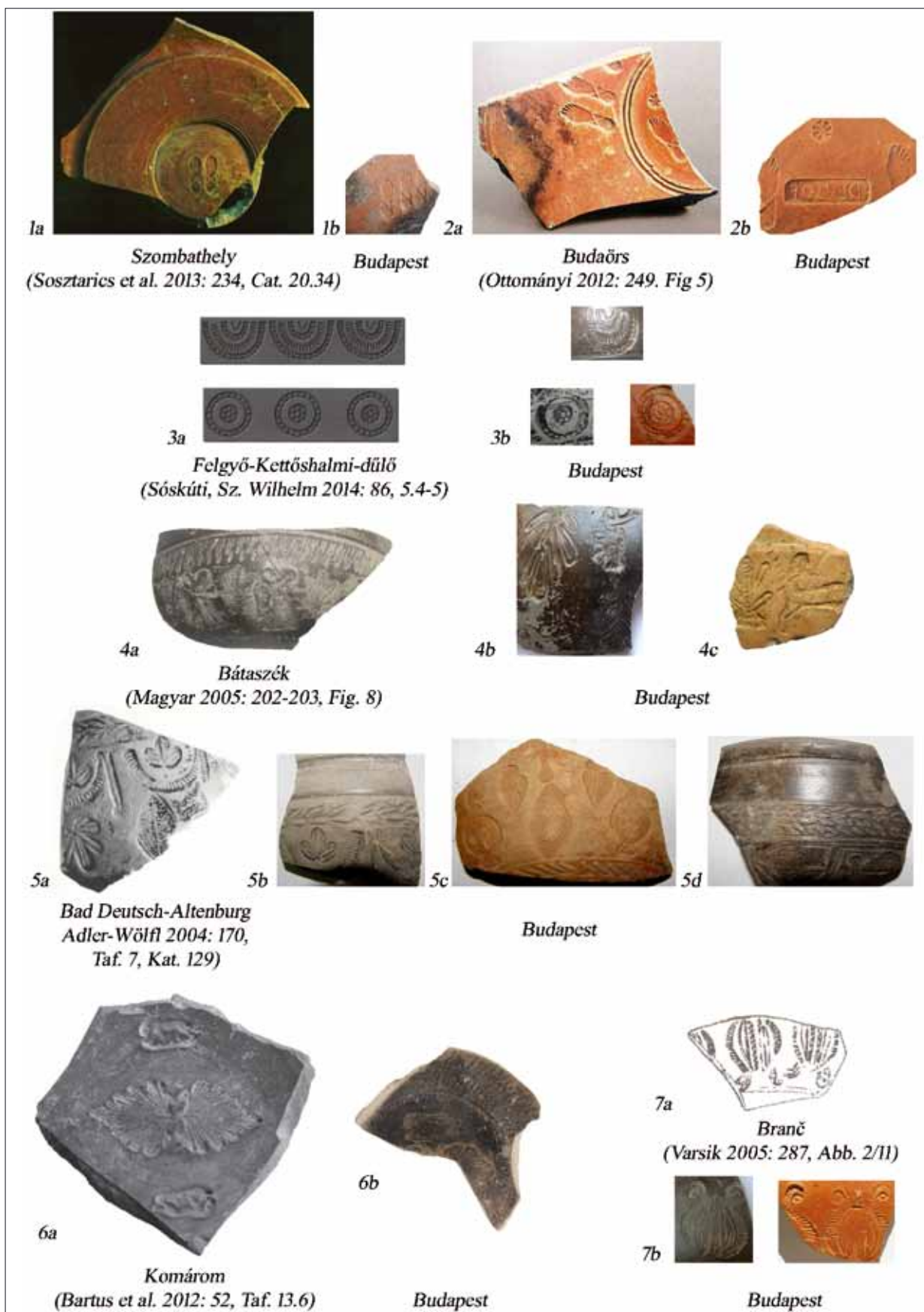

Fig. 3 Identification of motives (A. Nagy)

4. The workshop of Resatus could have been operating from the end of the 1st century AD using an amended collection of motifs.

5. According to the preliminary material analyses, the potential raw material of all analyzed vessels with a Resatus stamp (ten pieces from the Aquincum Museum) is represented by the local, so-called “Kiscell clay”, which was generally mined and used in Aquincum. We can assume that (one of) the workshop of Resatus was situated in the area of Aquincum. The Balatonfűzfő moulds (Palágyi 2003) still suggest that Resatus later moved to Aquincum or that he had multiple workshops – as Lajos Nagy, too (Nagy L. 1931: 54–56), presumed (**Fig. 3**).

The other types consist of smaller groups, which use combinations of a few motifs on the various vessels (**Fig. 4–5**). These include vessels similar in style to South Pannonian, and Singidunum stamped pottery which also make use of combinations of leaf ornaments, rosettes, curved sections and busts (e. g. Bjelajac 1991). Due to the presumably shared origin, similarities can also be found with a few Dacian types; concrete parallels and exact matches in motifs, however, are not yet known (e. g. Rusu-Bolindeț 2001).

The Macellum type I group (Láng, Nagy, Vámos 2014: 47–48) of the stamped vessels is based on the finds of Lajos Nagy, who thought they were the products of the supposed workshop to the south of the *macellum*. The decorations of the type I vessels were made using combinations of the same motifs (**Fig. 6**). A fragment with the characteristic ovolo was found in the cut excavated by Melinda Kaba. The filling of the cut can be dated to the 1st period, i.e. to the first half of the 2nd century, the latest (Láng, Nagy, Vámos 2014: 60).

Most groups can be dated to the late-1st and 2nd centuries. The stamped pottery from Aquincum mostly spread within the territory of the Civitas Eraviscorum, a few items, however, reached further (e.g. to Carnuntum, Bátaszék, modern-day Slovakia, Sarmatian settlements). A group, which differs in both form and decoration style, was produced more likely in the 3rd century and, beyond the Buda side, such vessels are often also found at Sarmatian sites (**Fig. 7**). According to the archaeometrical tests, the raw material of these types is from Aquincum (Korom 2015, 177).

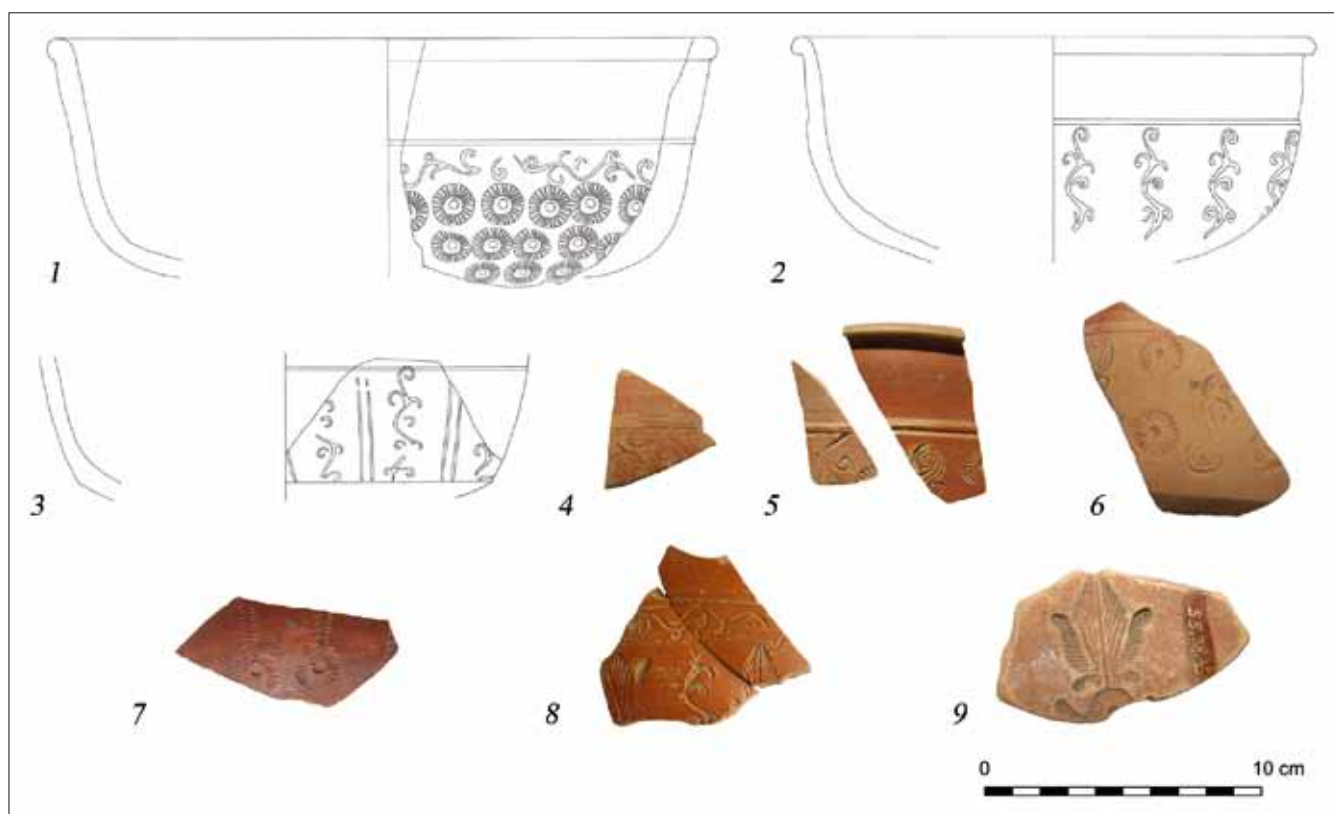

Fig. 4 Example of small group (A. Nagy)

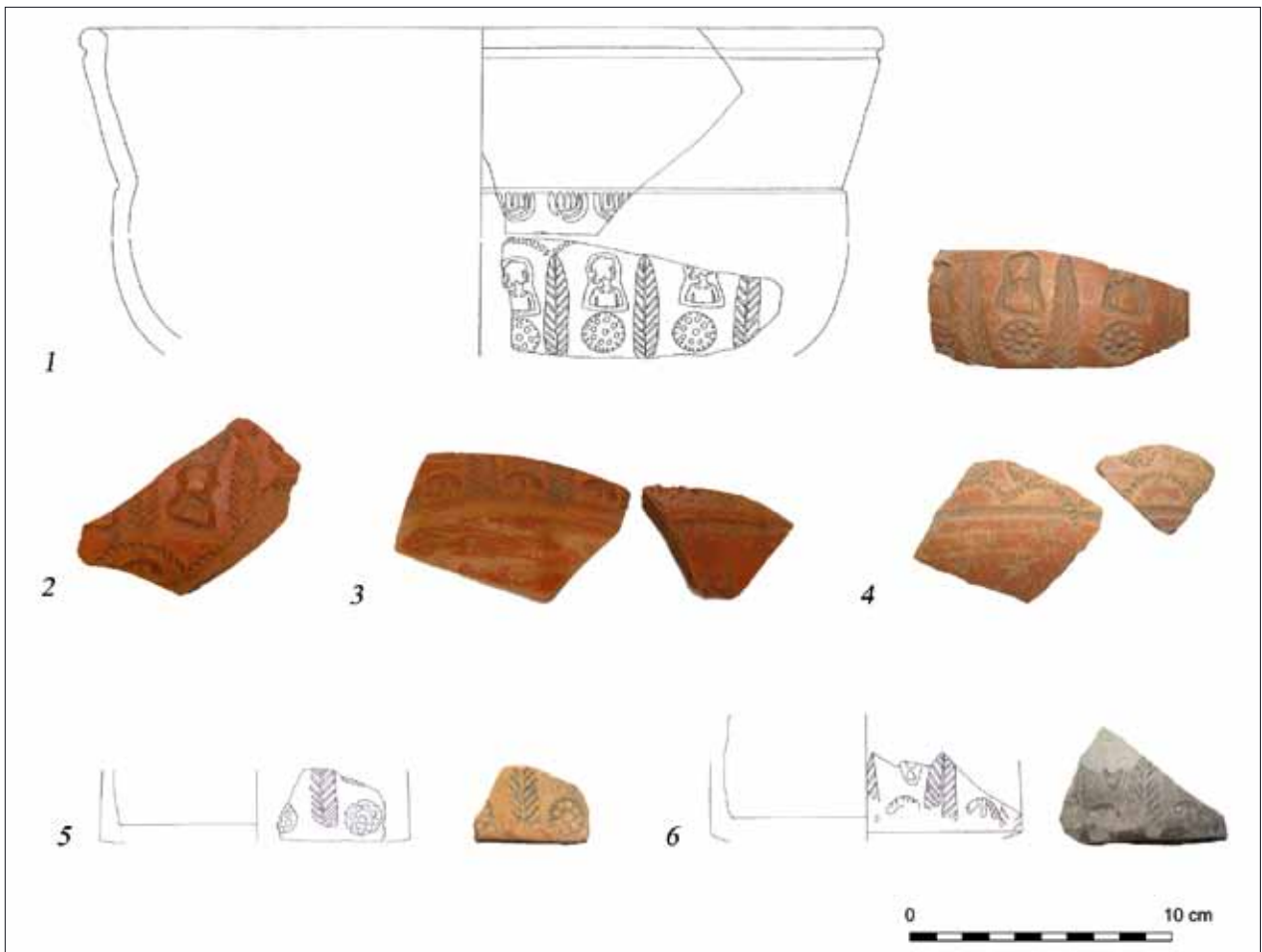

Fig. 5 Example of small group (A. Nagy)

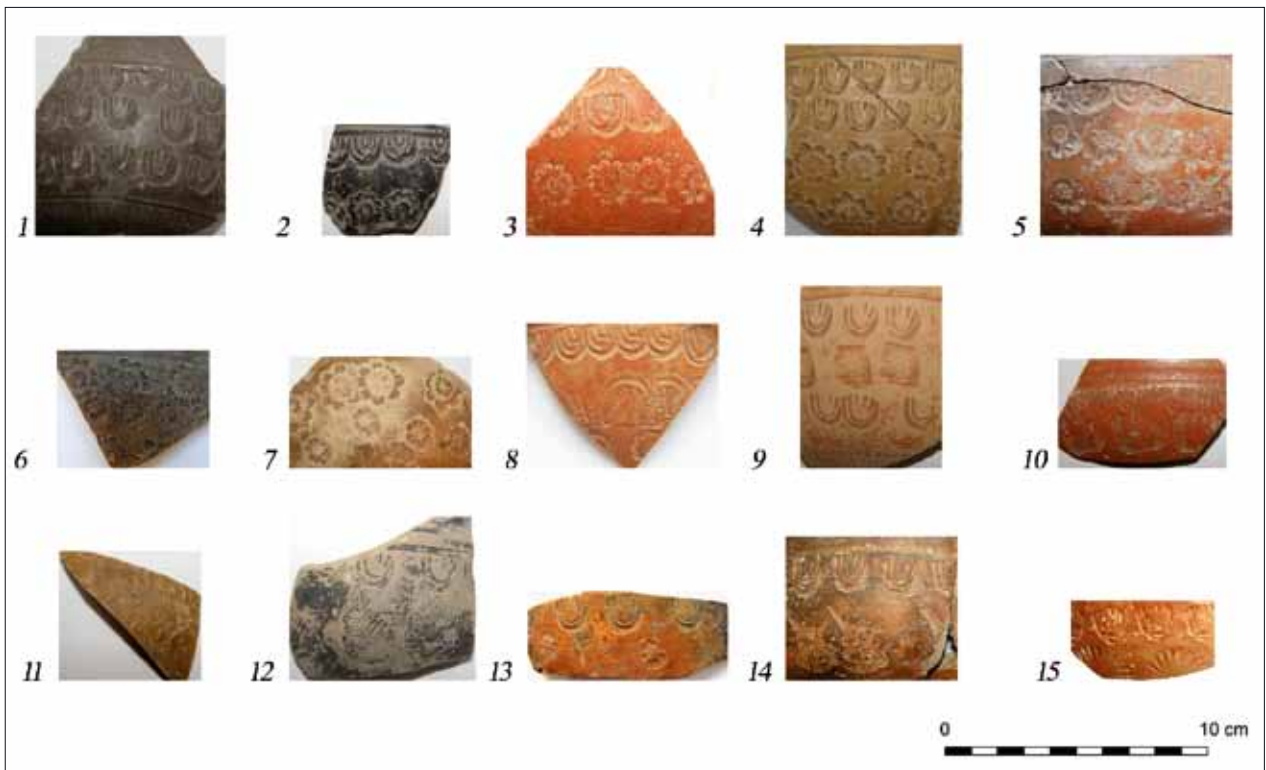

Fig. 6 The so-called Macellum group (A. Nagy)

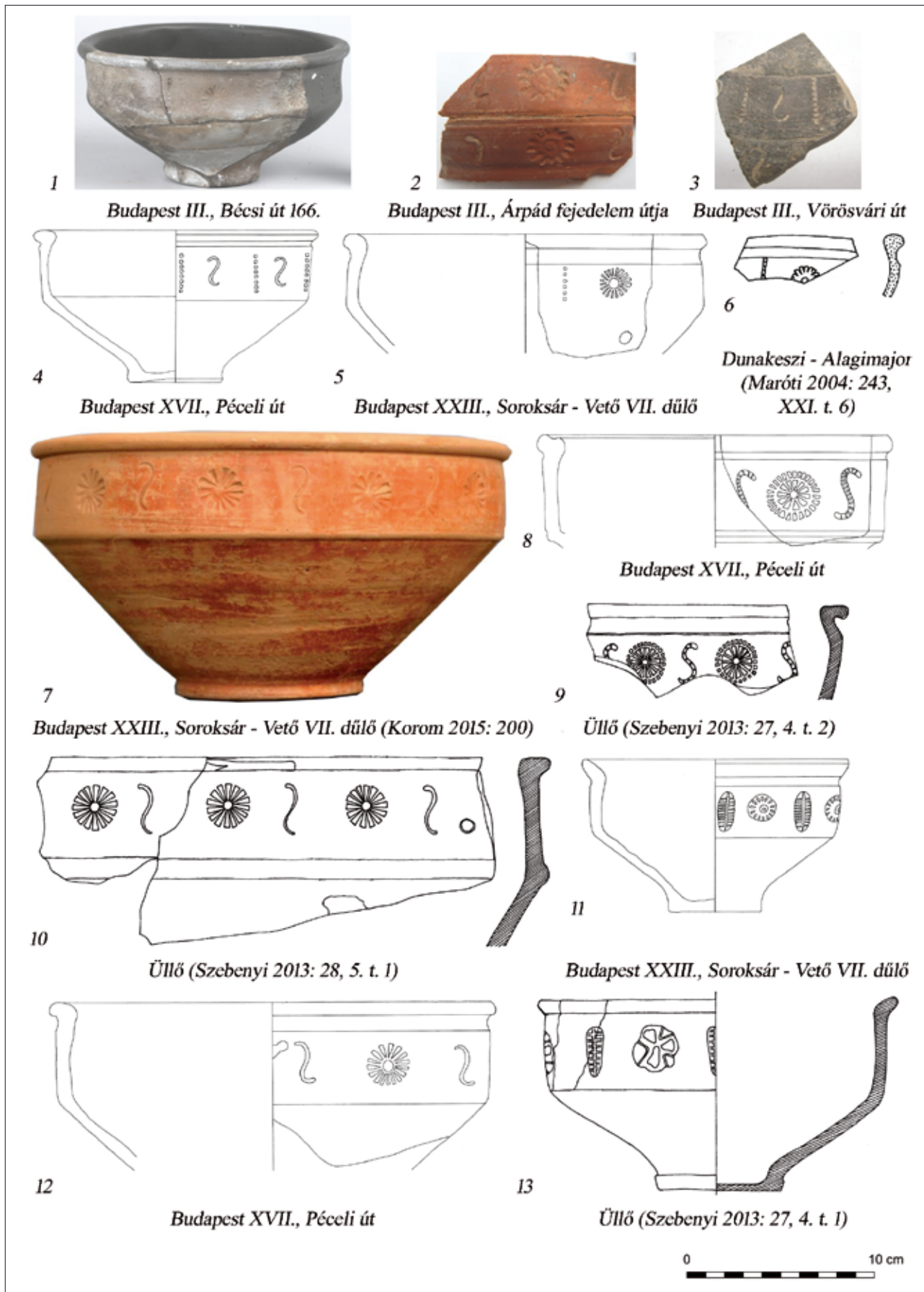

Fig. 7 Stamped vessels from the Buda side and Sarmatian sites (A. Nagy)

It is very important to notice that not only Resatus name stamps occur on vessels with grey slip. RESPECTVS F, NAMI, MARTIALIS, STROBILI, SAVA(?) stamp were also found here so far, but their possible workshops or other motives can not be identified most of the times (Nagy A. 2017: 34). One of the most important is the SAVA(?) stamp (**Fig 8**), which can be seen next to other motives and warns on the fact that several potters worked in the same style and produced *pannonische Glanztonware* vessels.

The number of motifs, which cannot be placed in a group and which only appear once on the vessels, is still high. These can only be placed in big categories (e.g. garlands, rosettes, leaves, animal-shapes, gem ornaments). Stamps can appear not only on bowls and plates but also on beakers, jugs, large ornamental vessels, and other kinds of tableware; hence the similarity in form, too, can give clues concerning classification and dating.

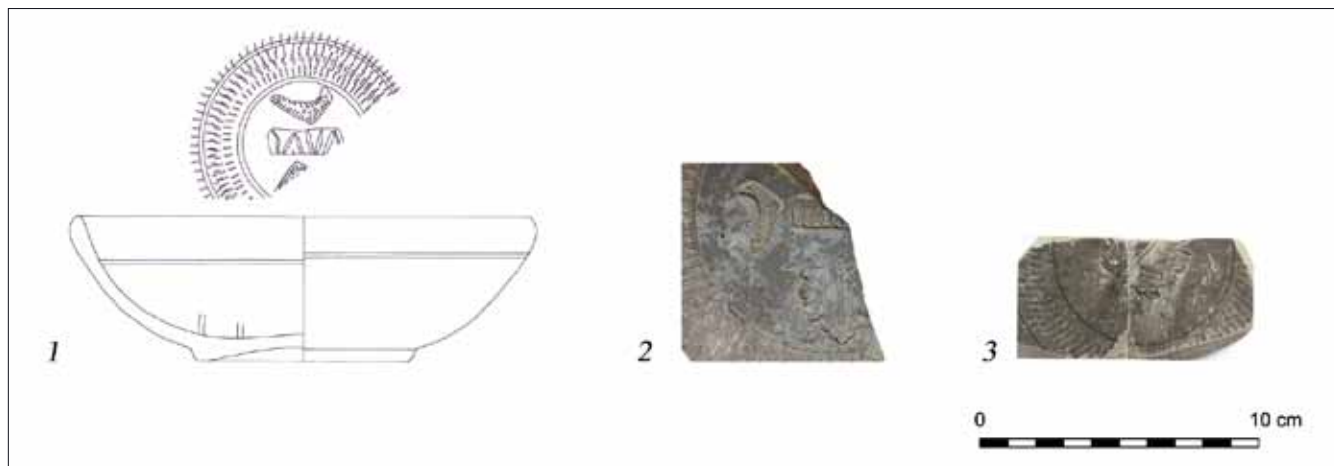

Fig. 8 The SAVA group (A. Nagy)

BIBLIOGRAPHY

- Adler-Wölfl, K. 2004, *Pannonische Glanztonware aus dem Auxiliarkastell von Carnuntum. (Ausgrabungen der Jahre 1977–1988)*, Wien
- Bartus, D., Borhy, L., Dévai, K., Kis, Z., Nagy, A., Sey, N., Számadó E., Szórádi, Zs., Vida I. 2012, Jelentés a Komárom–Szőny, Vásártéren 2010-ben folytatott régészeti feltárások eredményeiről / Bericht über Ergebnisse der in Komárom–Szőny, Vásártér im Jahre 2011 geführten archäologischen Ausgrabungen, *Komárom–Esztergom Megyei Múzeumok Közleményei*, Vol 18, 7–58.
- Bjelajac, Lj. 1991, Pečatna keramika Singidunuma / Singidunum stamped ceramics, *Zbornik narodnog muzeja u Beogradu*, Vol. 14, 419–425.
- Korom, A. 2015, A pesti-síkság barbaricum-i lelőhelyeinek pecsételt kerámiatípusai / Stamped pottery types from the Barbaricum sites of the Pest Plain, *Hadak útján*, Vol. 24, 165–203.
- Láng, O., Nagy, A., Vámos, P. 2014, *The Aquincum macellum*, Aquincum Nostrum, Vol. I.3, Budapest
- Magyar, Zs. 2015, Research in the Late La Tène – Early Roman Settlement at Bátaszék, Körtvélyesi-dűlő. The Early Roman Period, in: *Ländliche Siedlungen der römischen Kaiserzeit im mittleren Donauraum*, Bíró, Sz. – Molnár, A. (Hrsg.), Győr 2015, 197–224.
- Maróti, É. 2004, Újabb római kori pecsételt edénytöredékek Pest megyéből / Neue gestempelte Gefäßfragmente der Römerzeit aus dem Komitat Pest, *Studia Comitatus*, Vol. 28, 199–245.
- Nagy, A. 2016, Vessels with planta pedis stamp in the area of Aquincum, *Communicationes Archaeologicae Hungariae*, 2015–2016, 209–234.
- Nagy, A. 2017, *Resatus and the Stamped Pottery*, Aquincum Studies, Vol. 1, Budapest
- Nagy, L. 1931, *Az óbudai ókeresztény cella trichora a Raktár utcában / Die altchristliche Cella Trichora der Raktárgasse in Óbuda*, Budapest
- Ottományi, K. 2012, Római vicus Budaörsön / Der römische vicus von Budaörs, in: *Római vicus Budaörsön / Der römische vicus von Budaörs*, Ottományi K. (ed.), Budapest
- Palágyi, S. 2003, Római kori fazekastelep Balatonfüzfőn, in: *Térjünk a tárgyra!*, Schleicher, V. – Tóth, G. P. (eds.), Veszprém, 88–89.
- Rusu-Bolindeț, V. 2001, La céramique estampée de Napoca, *RCRF Acta* 37, 177–190.
- Soszarics, O., Balázs, P., Csapláros, A. (eds.) 2013, *A savariai Isis szentély I. Isis savariai otthona – kiállítási katalógus*. Sistrum – Serie A. No. 1.
- Sóskúti, K. – Sz. Wilhelm, G. 2014, Felgyő–Kettőshalmi-dűlőben (20/77, Nr. 85. lelőhely) feltárt szarmata településrészlet római eredetű leletanyaga / Finds of Roman origin from the Felgyő–Kettőshalom Excavation Site. *A Móra Ferenc Múzeum Évkönyve*, Vol. 1, 61–99.
- Szebenyi, T. 2013, Pecsételt kerámia Üllő 5. lelőhely szarmata telepéről / Bowls with stamped ornamentation at site Üllő 5, *Acta Iuvenum Sectio Archaeologica Tomus*, Vol. 1, 9–31.
- Varsik, V. 2005, Die kaiserzeitlichen Siedlungen im Pannonischen Vorfeld (Slowakei) im Lichte des keramischen Imports, in: *Limes XIX. Proceedings of the XIXth International Congress of Roman Frontier Studies*, Visy, Zs. (ed.), Pécs, 281–291.

SAŽETAK

PEČATNA KERAMIKA IZ AKVINKA

Ključne riječi:

Keramičke nalaze s pečatnim ukrasom iz Akvinka prvi je sustavno ispitivao Lajos Nagy. Od tada je prikupljanje referentnog materijala još uvijek u toku. Zbog istodobne pojave različitih motiva, ukrasnih stilova i oblika, posude s pečatnim ukrasom mogu se svrstati u veće skupine.