

# Rimsko selo u provinciji Gornjoj Panoniji: Virovitica Kiškorija Jug

---

**Jelinčić Vučković, Kristina**

**Authored book / Autorska knjiga**

*Publication status / Verzija rada:* **Published version / Objavljena verzija rada (izdavačev PDF)**

*Publication year / Godina izdavanja:* **2015**

*Permanent link / Trajna poveznica:* <https://um.nsk.hr/um:nbn:hr:291:693057>

*Rights / Prava:* [Attribution-NonCommercial 4.0 International/Imenovanje-Nekomercijalno 4.0 međunarodna](#)

*Download date / Datum preuzimanja:* **2024-09-08**

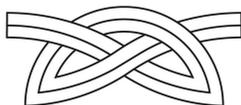

INSTITUT ZA  
ARHEOLOGIJU

*Repository / Repozitorij:*

[RIARH - Repository of the Institute of archaeology](#)



**RIMSKO SELO U PROVINCIJI GORNJOJ PANONIJI:  
VIROVITICA KIŠKORIJA JUG**

**ROMAN VILLAGE IN THE PROVINCE OF UPPER PANNONIA:  
VIROVITICA KIŠKORIJA SOUTH**

**KRISTINA JELINČIĆ VUČKOVIĆ**



**Rimsko selo u provinciji Gornjoj Panoniji:  
Virovitica Kiškorija Jug**  
**Roman Village in the Province of Upper Pannonia:  
Virovitica Kiškorija South**

Kristina Jelinčić Vučković

S priložima suradnika / With contributors:

Anja Bertol  
Karmen Farac  
Josip Halamić  
Ivana Ožanić Roguljić  
Ivan Radman-Livaja  
Siniša Radović  
Tajana Sekelj Ivančan  
Renata Šoštarić  
Tatjana Tkalčec  
Kristina Turkalj

Zagreb, 2015.

Monographiae Instituti archaeologici  
**Monografije Instituta za arheologiju / Monographs of the Institute of Archaeology**  
**MIA**  
**Knjiga 7**

INSTITUT ZA ARHEOLOGIJU / INSTITUTE OF ARCHAEOLOGY  
ZAGREB, 2015

## **IMPRESSUM**

**Monographiae Instituti Archaeologici 7**

**Rimsko selo u provinciji Gornjoj Panoniji: Virovitica Kiškorija Jug**

**Roman Village in the Province of Upper Pannonia: Virovitica Kiškorija South**

**Autorica / Author:**

**Kristina Jelinčić Vučković**

**Suradnici na knjizi / Contributing Associates:**

**Anja Bertol**

**Karmen Farac**

**Josip Halamić**

**Ivana Ožanić Roguljić**

**Ivan Radman-Livaja**

**Siniša Radović**

**Tajana Sekelj Ivančan**

**Renata Šoštarić**

**Tatjana Tkalčec**

**Kristina Turkalj**

**Recenzenti / Reviewers: Zoran Gregl, Angelina Raičković Savić, Lucijana Šešelj**

**ISBN 978-953-6064-13-7**

**CIP zapis je dostupan u računalnome katalogu Nacionalne i sveučilišne knjižnice u Zagrebu pod brojem 000898066.**

**Izdavač / Publisher: Institut za arheologiju / Institute of Archaeology, Ljudevita Gaja 32, HR-10000 Zagreb**

**Glavni urednik / Editor in chief: Marko Dizdar**

**Izvršni urednik / Desk editor: Ivana Ožanić Roguljić**

**Tehnički urednik / Technical editor: Bartul Šiljeg**

**Uredničko vijeće / Editorial committee: Eleni Schindler Kaudelka, Dénes Gabler, Janka Istenič**

**Lektura / Language editor: Ivan Ivančan**

**Prijevod / Translation: Suzana Čule, Siniša Radović, Ivana Ožanić Roguljić**

**Naklada / Circulation: 60**

**Tisak / Printed by: Tiskara Zelina d.d., Sv. I. Zelina**

**Prijelom / Layout: Hrvoje Jambreč**

**Nacrtna dokumentacija / Descriptive documentation: Kristina Turkalj, Maja Šunjić, Kristina Jelinčić Vučković**

**Crteži arheoloških nalaza / Drawings: Miljenka Galić, Suzana Čule, Ivan Valent**

**3D rekonstrukcije / 3D Reconstructions: Krešimir Vučković**

**Autori fotografija / Photos: Damir Doračić, Hrvoje Jambreč, Tatjana Tkalčec, Tajana Sekelj Ivančan, Kristina Jelinčić Vučković, Maja Šunjić, Dalibor Kereša**

**Sponzori i donatori / Sponsors and donors: Privredna banka Zagreb, Hotel Šulentić, BEMING d.o.o., IPZ Uniprojekt d.o.o., IPZ Niskogradnja d.o.o., Jedinstvo – Kartonaža d.o.o.**

## I DIO / PART I

<b>1. Uvod / Introduction</b>	<b>11</b>
<b>2. Arheološka iskopavanja i rezultati / Archaeological excavations and results</b>	<b>17</b>
2.1. Arheološka istraživanja i rezultati / Archaeological research and results	19
2.2. Smještaj lokaliteta i komunikacije / Location of the site and communication routes	23
2.3. Nepokretna arheološka građa / Immovable archaeological material	25
2.3.1. Arheološki kompleksi / Archaeological Complexes	35
2.3.2. Druge arheološke cjeline / Other archaeological units	72
2.3.3. Strukture za pripremu hrane i ognjišta / Food preparation facilities and hearths	88
2.3.4. Slojevi / Layers	95
2.3.5. Vrste objekata / Types of facilities	96

## II DIO / PART II

<b>3. Keramički oblici i njihov prostorni kontekst / Shapes of ceramics and their spatial context</b>	<b>101</b>
3.1. Uvod i slikovni pojmovnik (stručnih naziva korištenih u obradi keramike) / Introduction and pictorial glossary (of scientific vocabulary used in the chapter on ceramics)	103
3.2. Strukture keramičkog posuđa / The fabrics of ceramic dishes	107
3.3. Uporabna keramika lokalne proizvodnje: definicija, problematika proizvodnje i rasprostiranje / The locally made functional pottery: definition, issues related to production and distribution	119
3.3.1. Lonci / Pots	129
3.3.2. Zdjele / Bowls	142
3.3.3. Tanjuri / Plates	146
3.3.4. Poklopci / Lids	151
3.3.5. Tarionici / Mortars	155
3.3.6. Posude za čuvanje hrane i druge vrste posuđa / Vessels for food storage and other types of dishes	160
3.4. Stolno posuđe i posuđe dvostruke funkcije / Table ware and dual function dishes	165
3.5. Usporedba uporabne keramike lokalne proizvodnje s lokaliteta Virovitica Kiškorija Jug s takvom keramikom okolnih mikroregija / Comparing the locally produced functional ceramics from the Virovitica Kiškorija South Site to the similar ceramics produced in neighbouring micro-regions	169
3.6. Keramički utezi i pršljeni / Ceramic loom weights and whorls	181
3.7. Građevinski materijal / Building material	187
3.8. Katalog keramičkih predmeta (posuđe, utezi, pršljenovi i lijep) / Catalogue of ceramic items (dishes, weights, whorls and daub)	193
<b>4. Predmeti od stakla, metala, kamena i novac / Glass, metal and stone items, and coins</b>	<b>235</b>
4.1. Stakleno posuđe i katalog / Glass vessels and the catalogue (Kristina Turkalj)	237
4.2. Nakit od stakla i katalog / Glass jewellery and the catalogue (Kristina Jelinčić Vučković)	243

4.3. Metalni predmeti. Alati, oruđe, posuđe i ukrasni predmeti, katalog / Metal items. Tools, implements, vessels and decorative items, catalogue (Ivan Radman-Livaja, Karmen Farac)	247
4.4. Numizmatički nalazi s lokaliteta Virovitica Kiškorija jug / Numismatic finds from Virovitica Kiškorija south site (Anja Bertol)	257
4.5. Tragovi metalurške djelatnosti / Traces of metallurgical activity (Kristina Jelinčić Vučković)	261
4.6. Predmeti izrađeni od kamena, katalog / Stone items, catalogue (Josip Halamić, Kristina Jelinčić Vučković)	263
4.7. Table pokretne arheološke građe po cjelinama / Tables of movable archaeological findings by units	269

### III DIO / PART III

<b>5. Arheobotanički i arheozoološki nalazi: prehrambene navike; uzgoj biljaka i životinja na lokalitetu Virovitica Kiškorija jug / Archaeobotanical and archaeozoological finds: dietary habits; cultivation of plants and animal husbandry at the site of Virovitica Kiškorija South</b>	<b>299</b>
5.1. Životinjski ostaci iz rimskog i ranosrednjovjekovnog naselja na nalazištu Virovitica Kiškorija Jug / Animal remains from the Roman and early medieval settlements at the Virovitica Kiškorija South (Siniša Radović)	301
5.2. Biljni ostaci iz antičkog i srednjovjekovnog naselja na lokalitetu Virovitica Kiškorija Jug / Plant remains from the Roman and early medieval settlement at the site Virovitica Kiškorija South (Renata Šoštarić)	311
5.3. Interpretacija arheobotaničkih i arheozooloških nalaza iz rimskog konteksta prema povijesnim izvorima / Interpretation of archaeobotanical and archaeozoological finds from Roman contexts according to historical sources (Ivana Ožanić Roguljić)	327
<b>6. Virovitica Kiškorija Jug u ranom srednjem vijeku / Virovitica Kiškorija South during the early Middle ages (Tajana Sekelj Ivančan, Tatjana Tkalčec)</b>	<b>335</b>

### IV DIO / PART IV

<b>7. Virovitica Kiškorija Jug: primjer rimskog sela u Gornjoj Panoniji / Virovitica Kiškorija South: an example of a Roman village in the Upper Pannonia</b>	<b>349</b>
---	------------

### V DIO / PART V

<b>8. Popis literature i antičkih izvora / Bibliography and a list of ancient sources</b>	<b>361</b>
<b>9. Podaci o suradnicima na knjizi / Information on associates</b>	<b>373</b>







I DIO



PART I



1.

Uvod

*Introduction*





# 1.

## Uvod Introduction

Zahvaljujući brojnim zaštitnim arheološkim istraživanjima posljednjih deset godina, saznanja o životu u antici u hrvatskom dijelu rimske provincije Panonije znatno su upotpunjena, a naše je naslijeđe obogaćeno. Jedno takvo zaštitno istraživanje na trasi zapadne obilaznice grada Virovitice 2005. otkrilo je do sada u potpunosti nepoznato rimsko selo na lokalitetu *Virovitica Kiškorija jug*. Istraživanjem je omogućeno bolje poznavanje i interpretacija ruralnog života rimske Panonije na teritoriju Hrvatske. Taj zanemareni dio antike istraživanjem ovog, a kasnije i sličnih lokaliteta, ima veliku važnost, te smo njihovim iskopavanjima i multidisciplinarnim istraživanjima došli korak bliže potpunijem poznavanju antičkog načina života.

U organizaciji Uprave za zaštitu kulturne baštine Ministarstva kulture te uz financijsku potporu Hrvatskih cesta provedena su istraživanja na osam lokaliteta tijekom 2005. i 2006. godine na trasi zapadne obilaznice grada Virovitice. U velikim zaštitnim istraživanjima nužna je bliska suradnja između voditelja istraživanja, njegove institucije, lokalnog muzeja, Konzervatorskog odjela i Ministarstva kulture, kako bi se svi administrativni poslovi, ali i arheološko istraživanje proveli po propisima, u zadanim rokovima i na kvalitetan način. To su svakako omogućili predstavnici spomenutih institucija s kojima je ovom prilikom Institut za arheologiju surađivao: Dubravka Sabolić, Silvija Salajić, Željko Španiček, Viktorija Ciganović te Zoran Wiewegh.

Arheološko istraživanje vodila je Kristina Jelinčić Vučković iz Instituta za arheologiju u Zagrebu. Prilikom tog istraživanja veliku potporu pružili su kolegice i kolege s Instituta za arheologiju: Tajana Sekelj Ivančan, Tatjana Tkalčec, Marko Dizdar, Darija Ložnjak Dizdar, Željko Tomičić, Lida Matijević i Božena Bartol. Njihova pomoć i savjeti bili su vrlo dragocjeni!

U samim arheološkim iskopavanjima, pored voditeljice sudjelovali su: Tajana Sekelj Ivančan, Tatjana Tkalčec, Kristina Turkalj, Maja Šunjić, Ivana Miletić, Nikola Vukosavljević i tadašnji studenti arheologije na Filozofskom fakultetu u Zagrebu: Andreja Kudelić, Dalibor Kereša, Filomena Sirovica, Kristina Grubišić te 20 radnika. Nacrtnu i arheološku dokumentaciju izradile su Kristina Turkalj, Maja Šunjić i Tina Dasović; crteže nalaza Miljenka Galić, Suzana Čule i Ivan Valent, konzervaciju nalaza proveli su Maša Vuković Biruš (keramika) i Damir Doračić (metal i staklo). Pri izradi zračnih fotografija veliku pomoć pružili su nam vatrogasci iz Viro-

As a result of the numerous archaeological rescue excavations conducted during the last ten years, the knowledge about life in ancient times in the Croatian part of the Roman province of Pannonia has been significantly complemented and our heritage enhanced. One of these rescue excavations on the section of the city Virovitica western bypass, in 2005, brought to light a completely unknown Roman village at the *Virovitica Kiškorija South* site. The research enabled a better understanding and interpretation of rural life in Roman Pannonia on the Croatian territory. This neglected part of Antiquity gained great importance after this particular research and later excavations of similar sites. By excavating them and by using multidisciplinary research we came a step closer to a more comprehensive understanding of the ancient way of life.

Excavations were conducted in 2005 and 2006 at eight locations along the planned city bypass, and organized by the Directorate for the Protection of Cultural Heritage at the Ministry of Culture, with the financial support of the Croatian roads. Extensive rescue studies require a close collaboration between the project head, his institution, the local museum, the Conservation Department and the Ministry of Culture, in order to conduct all administrative activities, as well as the archaeological research itself, in accordance with the regulations, within the specified deadlines and in a quality manner. The following representatives of the above mentioned institutions, with which the Institute of Archaeology collaborated on this occasion, made this task possible: Dubravka Sabolić, Silvija Salajić, Željko Španiček, Viktorija Ciganović and Zoran Wiewegh.

Archaeological research was headed by Kristina Jelinčić Vučković from the Institute of Archaeology in Zagreb. The following colleagues provided invaluable support during the research: Tajana Sekelj Ivančan, Tatjana Tkalčec, Marko Dizdar, Darija Ložnjak Dizdar, Željko Tomičić, Lida Matijević and Božena Bartol. Their help and advice have been priceless indeed!

In addition to the project leader, the following colleagues were involved in actual archaeological excavations: Tajana Sekelj Ivančan, Tatjana Tkalčec, Kristina Turkalj, Maja Šunjić, Ivana Miletić, Nikola Vukosavljević, as well as the students of archaeology at the University of Zagreb at that time: Andreja Kudelić, Dalibor Kereša, Filomena Sirovica, Kristina Grubišić, plus twenty workers. Descriptive documentation was drafted by Kristina Turkalj, Maja Šunjić and Tina Dasović; findings were drawn by Miljenka Galić, Suzana Čule and Ivan Valent; conservation of findings was done by Maša Vuković Biruš (ceramics) and Damir Doračić (metal and glass). Fire-fighters from Virovitica, who have always been available, provided great help in aerial imaging.

vitice koji su nam uvijek bili na raspolaganju.

Zaštitnim istraživanjima na lokalitetu Virovitica Kiškorija jug, 2005. g. iskopana je površina od 17946 m<sup>2</sup>, a radovi su trajali od 13. svibnja do 9. srpnja 2005. Na lokalitetu je pronađeno rimsko selo koje se datira od 2. do 5. st., te rano srednjovjekovno naselje datirano od kraja 8. do kraja 10. st. Kolegice s Instituta, Tajana Sekelj Ivančan i Tatjana Tkalčec već su objavile radove o srednjovjekovnom naselju, a u ovoj se knjizi objavljuju nalazi iz rimskog sela i daje interpretacija rimskodobnog lokaliteta. S obzirom da smo prilikom istraživanja pronašli i srednjovjekovno naselje, nismo ga htjeli zaobići unatoč ranijim objavama, pa se donose glavne spoznaje uključujući nove detalje o metalnim nalazima te prehrani.

Istraživanjem je otkriven velik broj stupova koji su pripadali drvenim rimskim kolibama, zatim poluukopani objekti, peći, ostaci ogradna i bunari. Prije istraživanja i gradnje ceste, položaj je bio korišten kao poljoprivredno zemljište za uzgoj kamilice i kukuruza te je intenzivnom obradom tla lokalitet u svom površinskom dijelu oštećen. Nadalje, kiselost zemlje, potvrđena analizama, jako je oštetila sve nalaze i uzorke što je otežalo konzervaciju nalaza i interpretaciju uzoraka. Stratigrafsku čitljivost lokaliteta dodatno je kompliciralo i to što je pored antičkog postojalo i srednjovjekovno naselje koje se također sastojalo od stupova, poluukopanih objekata i jama.

Gustoća pronađenih objekata otežava interpretaciju i prepoznavanje smislenih cjelina. Ipak, analizom nalaza, rasporedom objekata te analogijama iz drugih sela, objavljenih prije svega u današnjoj Mađarskoj i Austriji, bilo je moguće doći do rezultata koji se donose u slijedećim poglavljima.

Među arheološkim nalazima najveću količinu čini loše izrađeno keramičko posuđe lokalne proizvodnje koje je poslužilo autorici kao podloga za izradu doktorske disertacije. U knjizi se uz keramiku lokalne proizvodnje obrađuje i ostalo keramičko posuđe, zatim predmeti od stakla (posuđe i nakit), metalni predmeti (novac, oruđe, nakit) i predmeti od kamena (žrvnjevi, brusovi).

U proteklih desetak godina, tijekom brojnih zaštitnih arheoloških istraživanja otkriveno je više rimskih sela na području južne Panonije. Značaj ove monografije je u tome što je ona prvo sveobuhvatno djelo u kojemu se analiziraju složeni stratigrafski podaci, pokretna arheološka građa i organski ostaci pronađeni u selu na multidisciplinarni način. Rezultat je poznavanje života u ovom selu na više razina i otkrivanje dijela ruralnog života u rimskoj Panoniji. Značaj lokaliteta Virovitica Kiškorija jug leži i u tome što se nalazi u regiji koja je, što se antike tiče, slabo istražena.

Tijekom iskopavanja uzeti su uzorci zemlje koji su flotirani te analizirani kao i životinjske kosti. Rezultati analiza omogućili su da prepoznamo koja su se jela i pića konzumirala.

During the rescue research at the Virovitica Kiškorija-South site in 2005, an area of 17,946 m<sup>2</sup> was excavated in the period from May 13<sup>th</sup> until July 9<sup>th</sup> 2005. A Roman village dating from the 2<sup>nd</sup> to the 5<sup>th</sup> century was discovered on the site as well as an early medieval settlement dating from the late 8<sup>th</sup> to the late 10<sup>th</sup> century. The colleagues from the Institute, Tajana Sekelj Ivančan and Tatjana Tkalčec, already published the papers concerning the medieval settlement, and this book deals with the findings from the Roman village and provides the interpretation of the Roman aspect of the site. Given the fact that during the research we also discovered the medieval settlement, we did not want to leave it out. Regardless of the earlier publications, herewith we present the main discoveries, including some new details on the metal findings and diet.

The excavations revealed a number of columns belonging to the Roman wooden shacks, half buried facilities, furnaces, remains of fences and wells. Prior to the research and the construction of the road, this location was used for growing chamomile and corn. As a result, the surface of the site was damaged due to an intensive agricultural cultivation. Furthermore, the acidity of the soil, confirmed by the analysis, damaged all of the findings and the samples which made them difficult to conserve and interpret. The stratigraphic readability of the site has been further complicated by the fact that next to an ancient there was also a medieval settlement which also consisted of columns, half buried facilities and pits.

Density of retrieved objects further complicates the interpretation and identification of meaningful structures. However, the analysis of the findings, the arrangement of objects and the analogies from other villages, published primarily in the present-day Hungary and Austria, made it possible to arrive at the conclusions presented in the chapters to follow.

Among the archaeological findings, the majority consists of poorly crafted pottery of local production, used by the author of this book as the basis for her doctoral thesis. Apart from the locally made ceramics, the book also deals with other ceramic dishes, as well as with the glassware (pots and jewellery), metal objects (coins, tools, jewellery) and objects made of stone (grindstones, whetstones).

In the past decade, during numerous rescue excavations, a number of Roman villages in southern Pannonia were discovered. The importance of this book lies in the fact that it is the first comprehensive work in which complex stratigraphic data, movable archaeological material and the organic remains found in the village are analyzed in a multidisciplinary way. The result is an understanding of life in this village at different levels as well as revelations of a part of the rural life in Roman Pannonia. The significance of the Virovitica Kiškorija South site lies in the fact that it is located in a region which is, as far as the Antiquity is concerned, poorly researched.

During the excavations, samples of earth, as well as animal bones, were taken, floated and analyzed. The results of the analysis have allowed us to recognize what kind of food and beverages were consumed in this village, with which plants and animals the population was in contact, what they cultivated and what they collected. Some small



mirala u ovom selu, s kojim su biljkama i životinjama bili u kontaktu, što su uzgajali i sakupljali. Pojedini sitni nalazi i uzorci predmet su analize i obrade suradnika (Anja Bertol, Karmen Farac, Josip Halamić, Ivana Ožanić Roguljić, Ivan Radman-Livaja, Siniša Radović, Tajana Sekelj Ivančan, Renata Šoštarić, Tatjana Tkalčec, Kristina Turkalj) kojima se zahvaljujem na sudjelovanju u stvaranju knjige.

Na kraju uvoda, želim se zahvaliti svima koji su sudjelovali u istraživanjima i administraciji, obradi nalaza i izradi dokumentacije, konzervaciji, izradi analiza, uredništvu knjige te sponzorima i donatorima jer su svi na svoj način doprinijeli konačnim rezultatima i objavi ove knjige.

Posebno se zahvaljujem kolegicama i kolegama Suzani Čule, Juraju Belaju, Kristini Turkalj, Bartulu Šiljegu i Ivani Ožanić Roguljić na pomoći i suradnji.

finds and samples have been analyzed and processed by contributing associates (Anja Bertol, Karmen Farac, Josip Halamić, Ivana Ožanić Roguljić, Ivan Radman-Livaja, Siniša Radović, Tajana Sekelj Ivančan, Renata Šoštarić, Tatjana Tkalčec, Kristina Turkalj) whom I would like to thank for taking an active part in the making of this book.

At the end of this introduction, I would like to thank everyone who participated in the research, in administration, in processing of the findings and in preparing of the documentation. My thanks are due to those who did the conservation works, as well as to those who prepared relevant analyses and to those responsible for editing the book. Also, I would like to express my gratitude to the sponsors and donors for their contribution to the final result and the publication of this book.

I would like to thank especially to colleagues Suzana Čule, Juraj Belaj, Kristina Turkalj, Bartul Šiljeg and Ivana Ožanić Roguljić for their help and cooperation.





2.

Arheološka iskopavanja i rezultati

*Archaeological excavations and results*





## 2.1.

### Arheološka iskopavanja i rezultati *Archaeological excavations and results*



Sl. 1 Početak arheoloških radova  
*Fig. 1 The beginning of archaeological works*

Tijekom 2005. godine, prije početka izgradnje zapadne obilaznice grada Virovitice provedeno je nekoliko zaštitnih arheoloških iskopavanja. Tom prigodom istražen je lokalitet Virovitica Kiškorija jug. Smješten je s južne strane Podravske magistrale (sl. 1–3, karte 1–2), na zapadnom ulazu u grad Viroviticu, a istočno od sela Korija.

In 2005, prior to the construction of the Virovitica western bypass, several rescue archaeological excavations were conducted. The Virovitica Kiškorija South was explored at the time. The site is located on the south side of the Podravina Highway (fig. 1–3, map 1–2), at the western entrance to the Virovitica city and east of the village Korija.



Sl. 2 Pogled prema Bilogori s lokaliteta Virovitica Kiškorija jug  
*Fig. 2 A view of the Bilogora from Virovitica Kiškorija South site*



Zaštitna arheološka istraživanja na lokalitetu Virovitica Kiškorija jug izvršena su u razdoblju od 13. svibnja do 9. srpnja 2005. g. Istraženi dio lokaliteta, odnosno trase, pruža se u pravcu sjeverozapad – jugoistok, a iskopana površina iznosi 17946 m<sup>2</sup>. Rekognosciranjem trase na položaju Virovitica Kiškorija jug uočeni su ulomci srednjovjekovne keramike zbog čega se pristupilo zaštitnim istraživanjima prilikom kojih je uočeno da se na ovom mjestu nalazilo i rimsko selo. U ovom rimskom selu se od 2. do sredine 5. st. odvijao vrlo intenzivan život, a srednjovjekovno naselje datira od 8. do 10. st. Veći dio lokaliteta pripada antičkom naselju.

Archaeological rescue excavations at the Virovitica Kiškorija South site were carried out during the period from May 13<sup>th</sup> to July 9<sup>th</sup> 2005. The investigated part of the site, or the route, extends in direction northwest-southeast, and the excavated area covers 17,946 m<sup>2</sup>. During the survey of the route, at the position Virovitica Kiškorija South, fragments of medieval pottery were observed. Rescue excavations were undertaken and it was established that a Roman village was located at this very site. In this Roman village a rather intense life took place from the 2<sup>nd</sup> to mid-5<sup>th</sup> century, and the medieval settlement dates from the 8<sup>th</sup> to the 10<sup>th</sup> century. Most of the site pertains to the antique settlement.

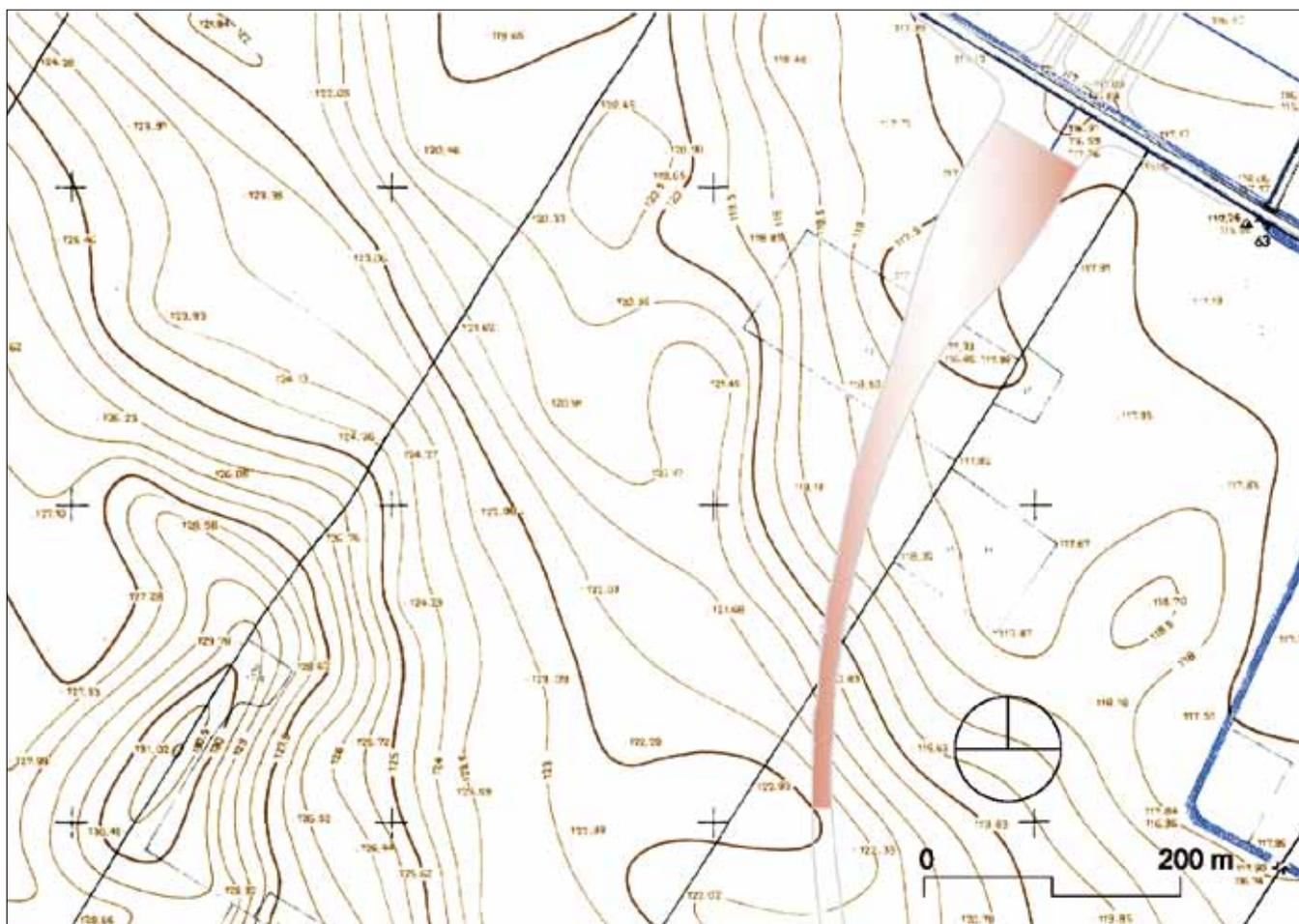

Karta 1 Položaj lokaliteta Virovitica Kiškorija jug na trasi obilaznice  
Map 1 Location of the Virovitica Kiškorija South site along the route of the bypass



Sl. 3 Zračni snimak lokaliteta Virovitica Kiškorija jug, pogled prema sjeveru  
Fig. 3 Aerial photo of the Virovitica Kiškorija South site, view from the north



## 2.2.

### Smještaj lokaliteta i komunikacije *Location of the site and communication routes*

Pod obroncima Bilogore, između dvije važne antičke prometnice - rijeke Drave i ceste koja je spajala velike centre Petovij i Mursu, smjestilo se rimsko selo Virovitica Kiškorija jug nepoznatog rimskog imena. Selo je smješteno u rimskoj provinciji Gornjoj Panoniji, a u kasnoj antici bilo je dio Panonije Savije.

Iako nije bilo smješteno direktno na nijednoj od prometnica, Dravom ili magistralnom cestom, stanovnici ovog sela bili su povezani s više naselja i gradova: u blizini su se nalazili *Bolentio* (Orešac), *Cocconis* na području Špišić Bukovice te *Serota/Sirotis* na području Virovitice. Pored njih, ovim važnim prometnicama selo je bilo povezano i s većim centrima: *Poetovio*, *Iovia* i *Mursa* (*Itinerarium Hierosolymitanum*, 560–63; *Itinerarium Antonini* 129–31), (Lengyel, Radan 1980: 213–215). Pored današnjeg sela Korija, spominje se i postojanje odvojka rimske ceste koji je vodio od glavne prometnice prema Dravi (Schejbal 2003a: 97, 106). Radi prometne povezanosti, očekivao se veći stupanj romanizacije, međutim, analiza nalaza provedena u narednim poglavljima, to je opovrgnula i ukazala na jaku prapovijesnu tradiciju.

Razlozi višestoljetnog zaposjedanja ovog područja u antici vjerojatno su dobra prometna povezanost i prirodna bogatstva Podravine, koja su osiguravala tlo za poljoprivrednu i stočarsku djelatnost. U neposrednoj blizini lokaliteta, prolazi i potok Ođenica što je svakako važan podatak jer je bio je važan argument za osnivanje naselja na ovom položaju. Postojanje naselja iz drugih razdoblja na ovom i bližem području govori o njegovoj pogodnosti za stanovanje (Sabolić 2007).



Karta 2 Položaj lokaliteta Virovitica Kiškorija jug  
Map 2 Position of Virovitica Kiškorija south

At the foot of the Bilogora Mt., between two important ancient routes – the Drava River and the road connecting the major centres *Poetovio* and *Mursa*, lies the Roman village Virovitica Kiškorija south, its Roman name being unknown to us. The village is situated in the Roman province of Upper Pannonia, and in the late Antiquity it was a part of Pannonia Savia.

Although it was not located directly on either of these routes, its residents had access to several towns and cities in its vicinity: *Bolentio* (Orešac), *Cocconis* in the area of Špišić Bukovica and *Serota/Sirotis* in the area of Virovitica. In addition, the village was also connected with the following major centres: *Poetovio*, *Iovia* and *Mursa* (*Itinerarium Hierosolymitanum*, 560–63; *Itinerarium Antonini* 129–31), (Lengyel, Radan 1980: 213–215). Besides the present-day village of Korija, also mentioned is a branch of the Roman road heading towards the Drava River (Schejbal 2003a: 97, 106). These road connections would suggest a larger degree of Romanization, but the analysis of findings presented in the chapters to follow contradicts the above expectations, showing a strong prehistoric tradition.

Good transport connections and natural resources of Podravina, which provided the soil for agriculture and cattle breeding, are probably the reasons of centuries-long colonisation of this area during the Antiquity. In the immediate vicinity of the site there is the Ođenica stream, which is by all means an important information, because it was a prerequisite for setting up a settlement on this position. Existence of settlements from other periods on this and in a neighbouring area offers enough evidence of its liveability (Sabolić 2007).





## Nepokretna arheološka građa *Immovable archaeological material*

Tijekom iskopavanja definirano je 2337 stratigrafskih jedinica datiranih u antiku i srednji vijek. Iz antičkog razdoblja definirana su 33 različita nadzemna objekta, 2 nadzemna objekta s plitko ukopanim dijelom, 8 poluukopanih objekata, 118 jama, 2 strukture za kuhanje, 5 ognjišta, 6 kanala, 896 stupova, 7 slojeva, 3 bunara (samo je jedan sigurno rimski). Selo se sastojalo od poluukopanih objekata i koliba građenih kombinacijom drva i lijepa. Često popravljavanje ili izgradnja novih objekata na istom mjestu rezultiraju velikim brojem stupova, objekata, ograda, poluukopanih objekata nanizanih jedan do drugog što onemogućuje interpretaciju svih stratigrafskih jedinica i razumijevanje njihova odnosa.

Prilikom interpretacije nepokretnih cjelina uzeo se u obzir međusobni odnos pojedinih stratigrafskih jedinica, funkcija i vremenska pripadnost nalaza koji su u njima nađeni kao i <sup>14</sup>C datumi za one cjeline koje su tom metodom datirane. Analizom stratigrafskih jedinica i nalaza, definirano je 9 cjelina koje se sastoje od više stratigrafskih jedinica, nazivamo ih *kompleksi*. Osim njih, opisuju se i veće arheološke cjeline, dok se stupove komentira i opisuje ukoliko su u njima nađeni nalazi koje traže posebnu pažnju.

Objekti su koncentrirani na dva položaja (sl. 4) između kojih je razmak od 54 m na istraženom dijelu lokaliteta, u slučaju i rimskog i srednjovjekovnog naselja. Prostorni diskontinuitet može biti uzrokovan unutarnjom organizacijom naselja, odnosno društvenim ustrojem i nekim drugim razlozima. Takvi su prekidi zabilježeni na nekim rimskim selima u Panoniji (Leleković, Rendić-Miočević 2012: 300). Ipak, u slučaju Virovitice Kiškorije jug, čini se da taj prekid postoji zbog toga što se na prekinutom dijelu teren snižava: na njemu se dugo zadržava voda nakon padalina, a prisutne su i podzemne vode. Tome smo svjedočili i tijekom istraživanja, kada se nakon dvodnevne kiše na tom sniženom dijelu voda zadržala danima. Na karti 1 se može vidjeti kako teren, koliko god se to čini na prvi pogled, ipak nije ravan, već postoje visinske oscilacije. Na južnom i ujedno najvišem dijelu istraženog lokaliteta zabilježena je i najveća koncentracija objekata.

During the excavations a total of 2337 defined stratigraphic units dated from Antiquity to Middle Ages were defined. There are 33 different surface structures dating from the Antiquity, two surface structures with a shallow buried part, eight pit houses, 118 pits, 2 cooking structures, 5 hearths, 6 channels, 896 postholes, 7 layers and 3 wells (only one being positively Roman). The village consisted of pit houses and huts built in combination of wood and daub. The large number of postholes, buildings, fences and half-buried objects, arranged next to each other, is a result of frequent repairs or of the construction of new buildings on the same location, which, ultimately, prevents interpretation of stratigraphic units and understanding their respective relations.

In understanding of immovable units, the relationship of individual stratigraphic units, as well as the function and temporal determination of findings found in them, was taken into account; the <sup>14</sup>C dates for those units which have been dated by this method were also considered. The analysis of stratigraphic units and findings defined nine units consisting of multiple stratigraphic units called *complexes*. Besides them, also described are the larger archaeological units, whereas the postholes are discussed and described only if finds which require special attention are found inside the posthole holes.

The structures are concentrated at two positions (fig. 4), at a distance of 54 m between them, on the excavated part of the site, both in case of the Roman and the medieval settlement alike. This spatial discontinuity might be caused by an internal organization of the settlement, i.e. by social organization and some other reasons. Such discontinuance is recorded in some Roman villages in Pannonia (Leleković, Rendić-Miočević 2012: 300). However, in case of Virovitica Kiškorija south, it seems that this discontinuation was due to a lower terrain in that area and subsequent rainwater retentions, as well as to subterranean waters. This was also observed during the research as well, when, after two days of heavy rain, rainwater retained in that area for days. The map 1 shows that the terrain, as much as it seems to be flat at first glance, is not even, but rather undulated with altitudinal fluctuations. The southern and at the same time the highest part of the excavated site features the highest concentration of structures.

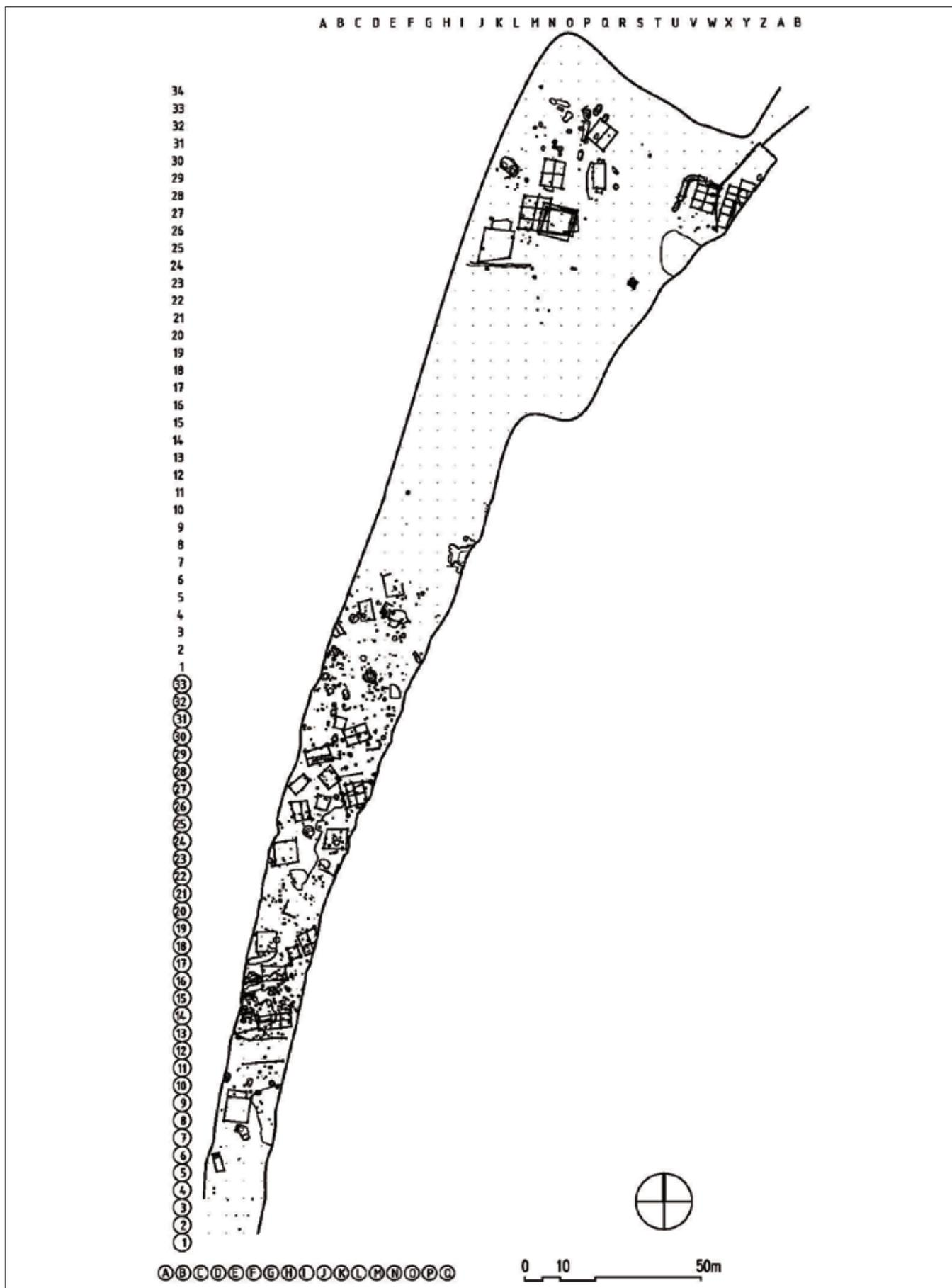

Sl. 4 Tlocrt lokaliteta, sjeverni i južni dio zajedno  
Fig. 4 Layout of the site, the northern and the southern part

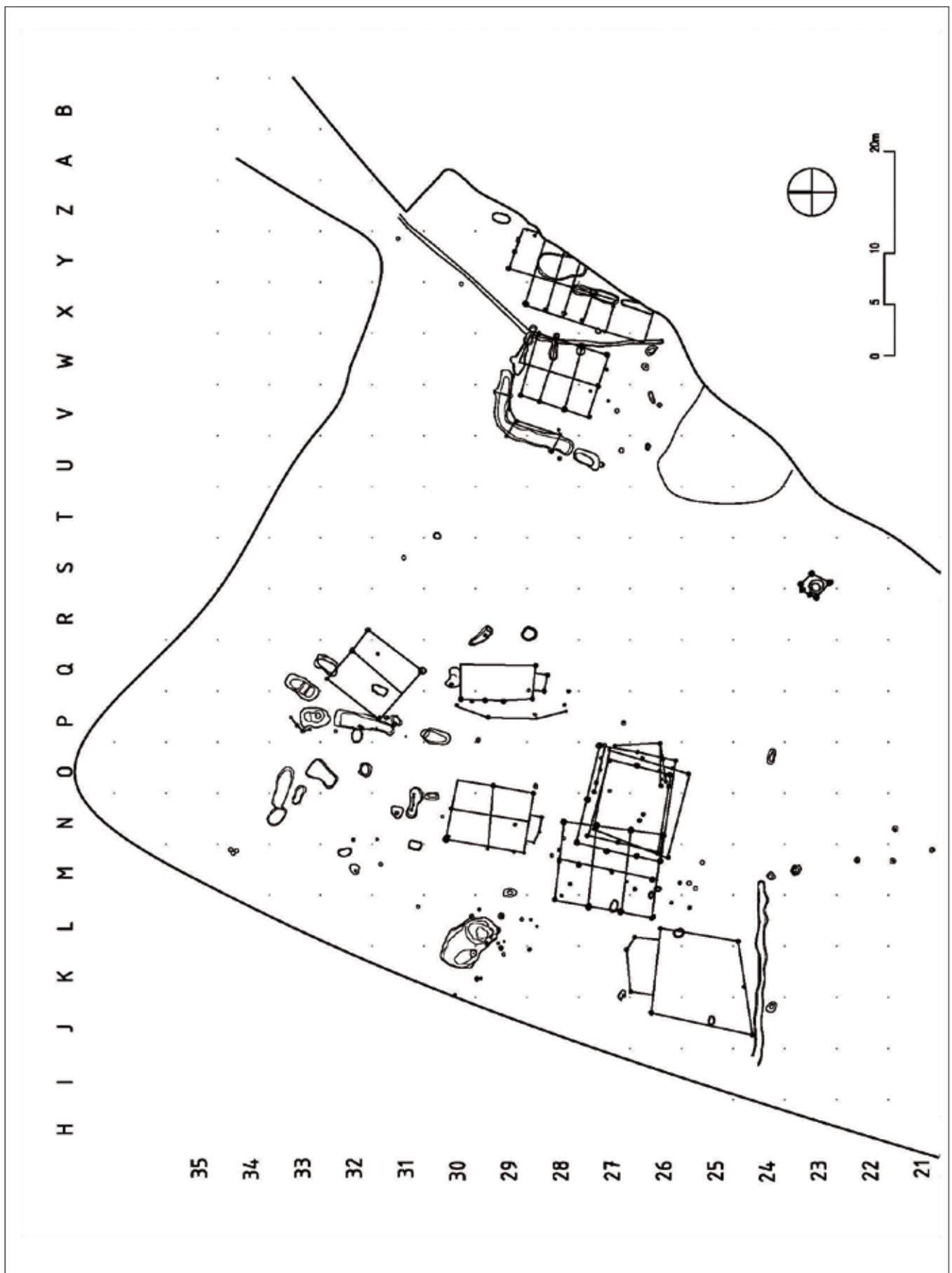

Sl. 5 Tlocrt sjevernog dijela lokaliteta, sektori VI–VIII  
 Fig. 5 Layout of the northern part of the site, sectors VI–VIII





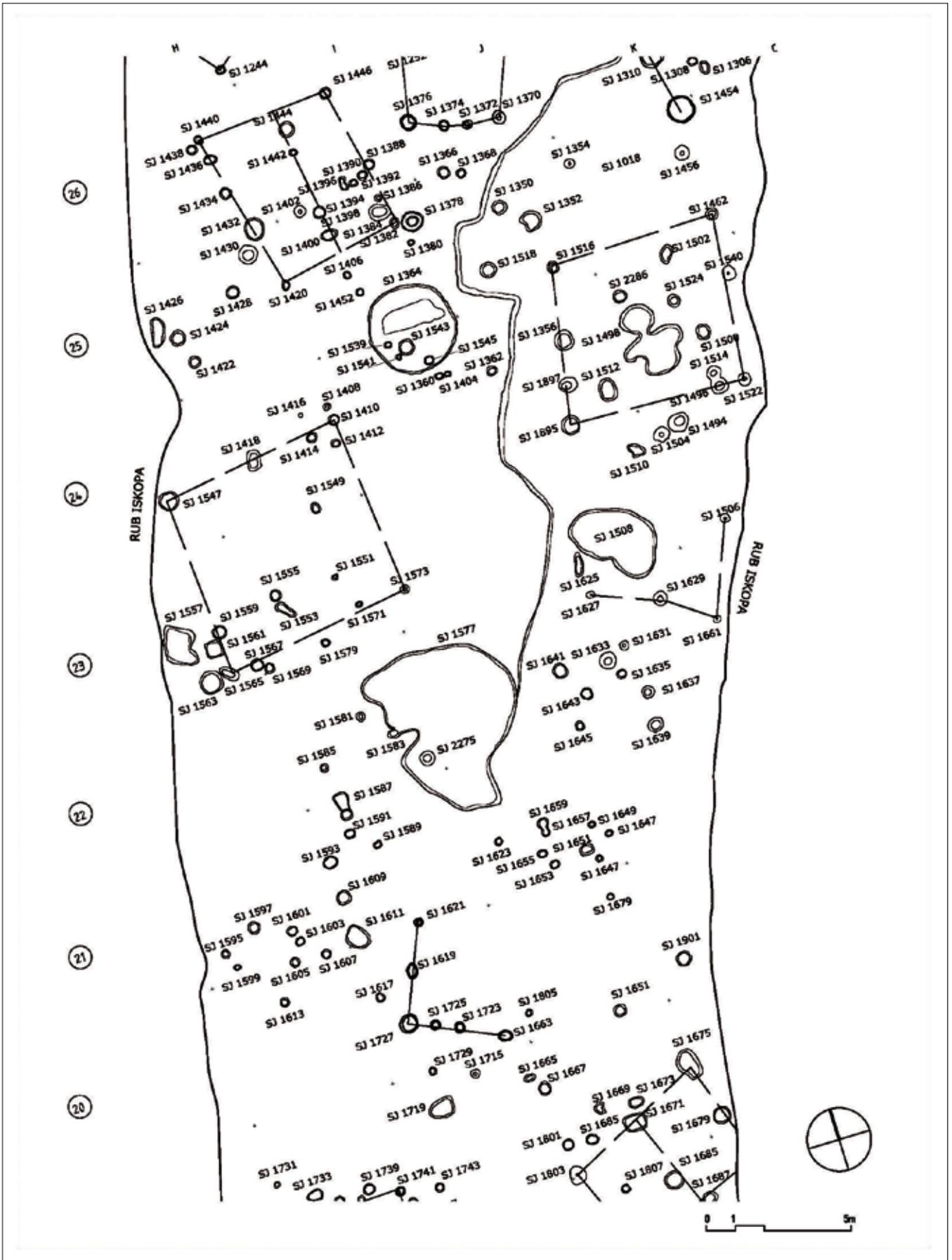

Sl. 8 Tlocrt južnog dijela lokaliteta od sjevera prema jugu 3/7  
 Fig. 8 Layout of the southern part of the site, from the north to the south 3/7

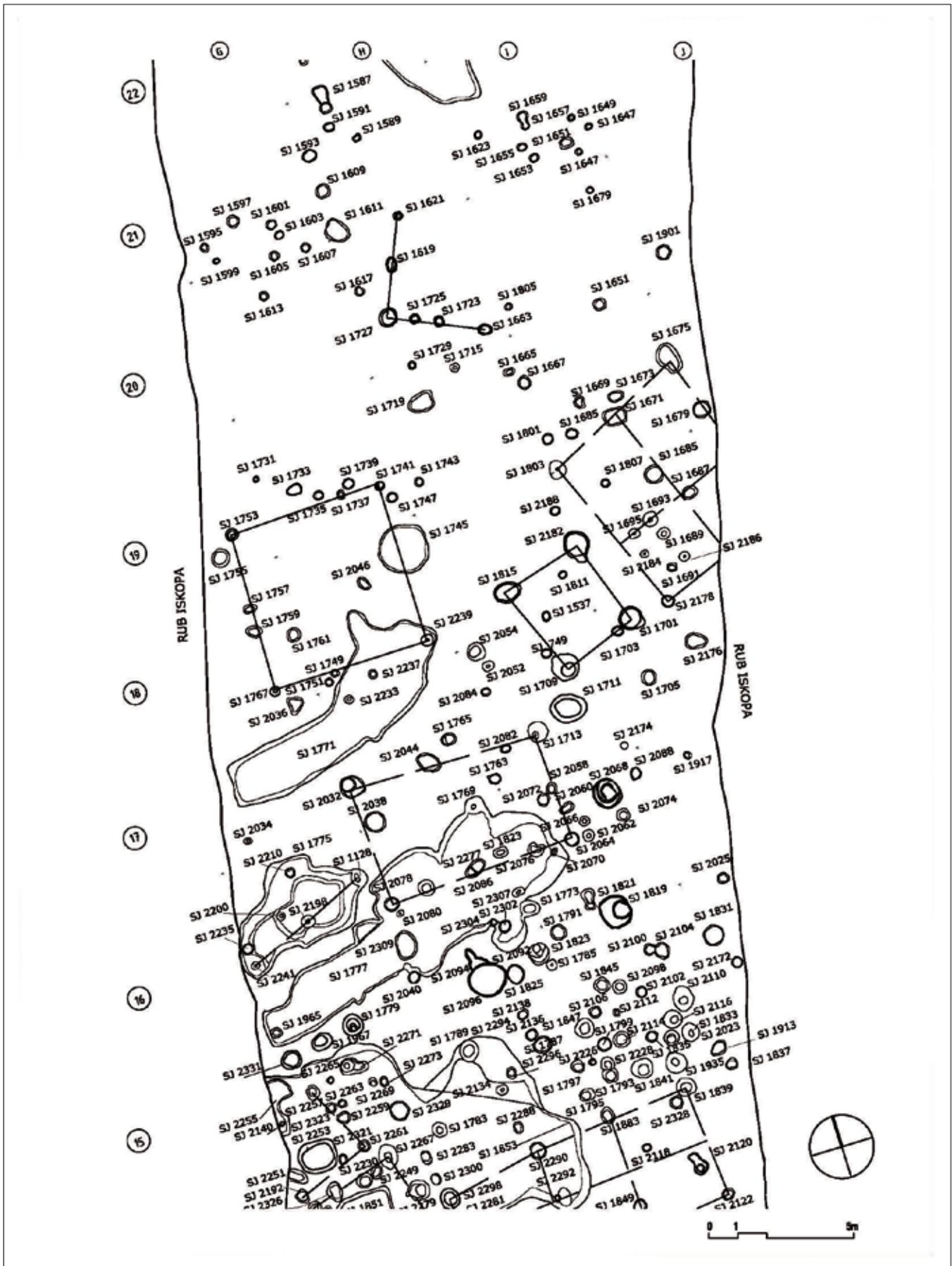

Sli. 9 Tlocrt južnog dijela lokaliteta od sjevera prema jugu 4/7  
 Fig. 9 Layout of the southern part of the site, from the north to the south 4/7



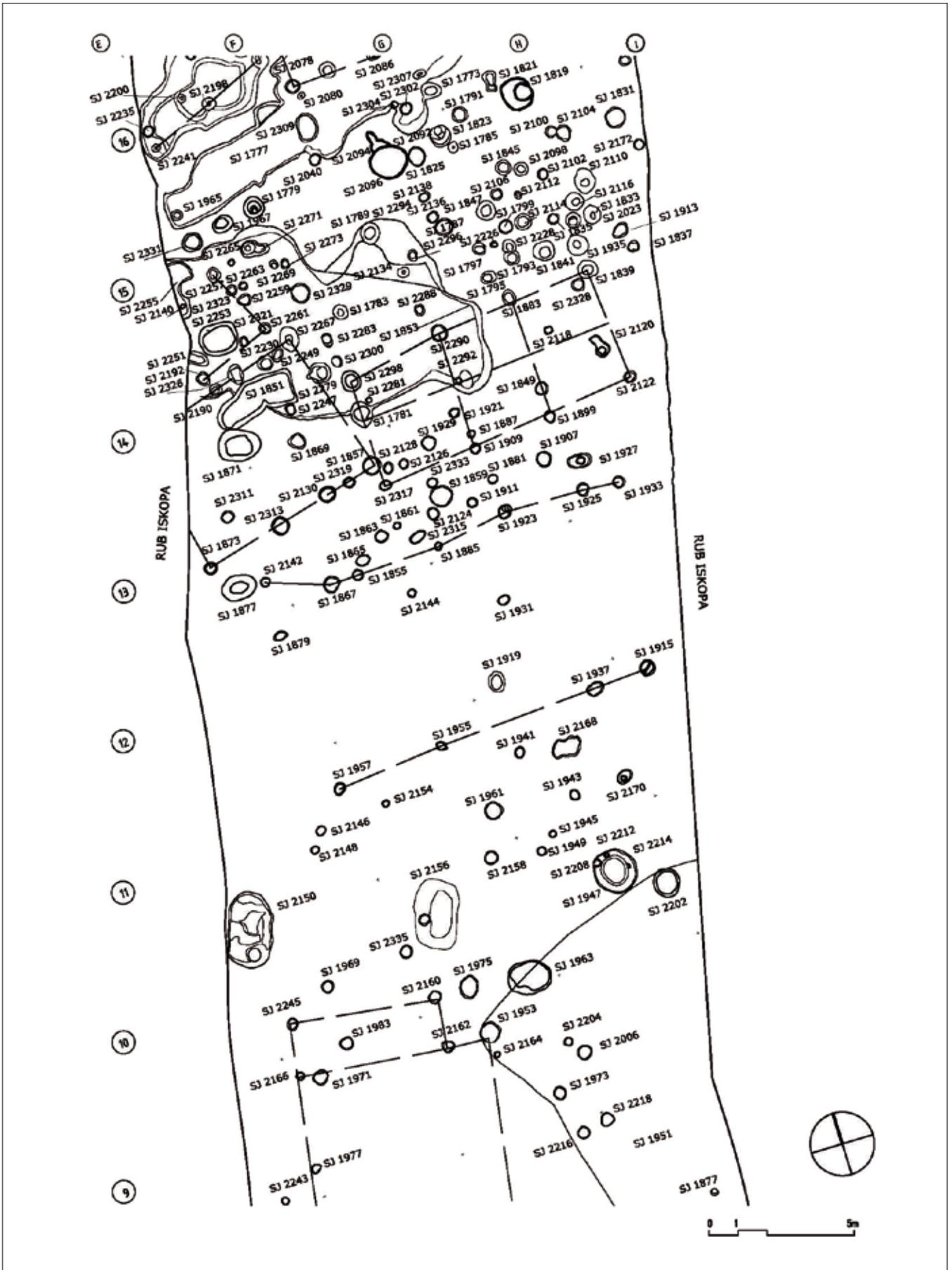

Sl. 10 Tlocrt južnog dijela lokaliteta od sjevera prema jugu 5/7

Fig. 10 Layout of the southern part of the site, from the north to the south 5/7

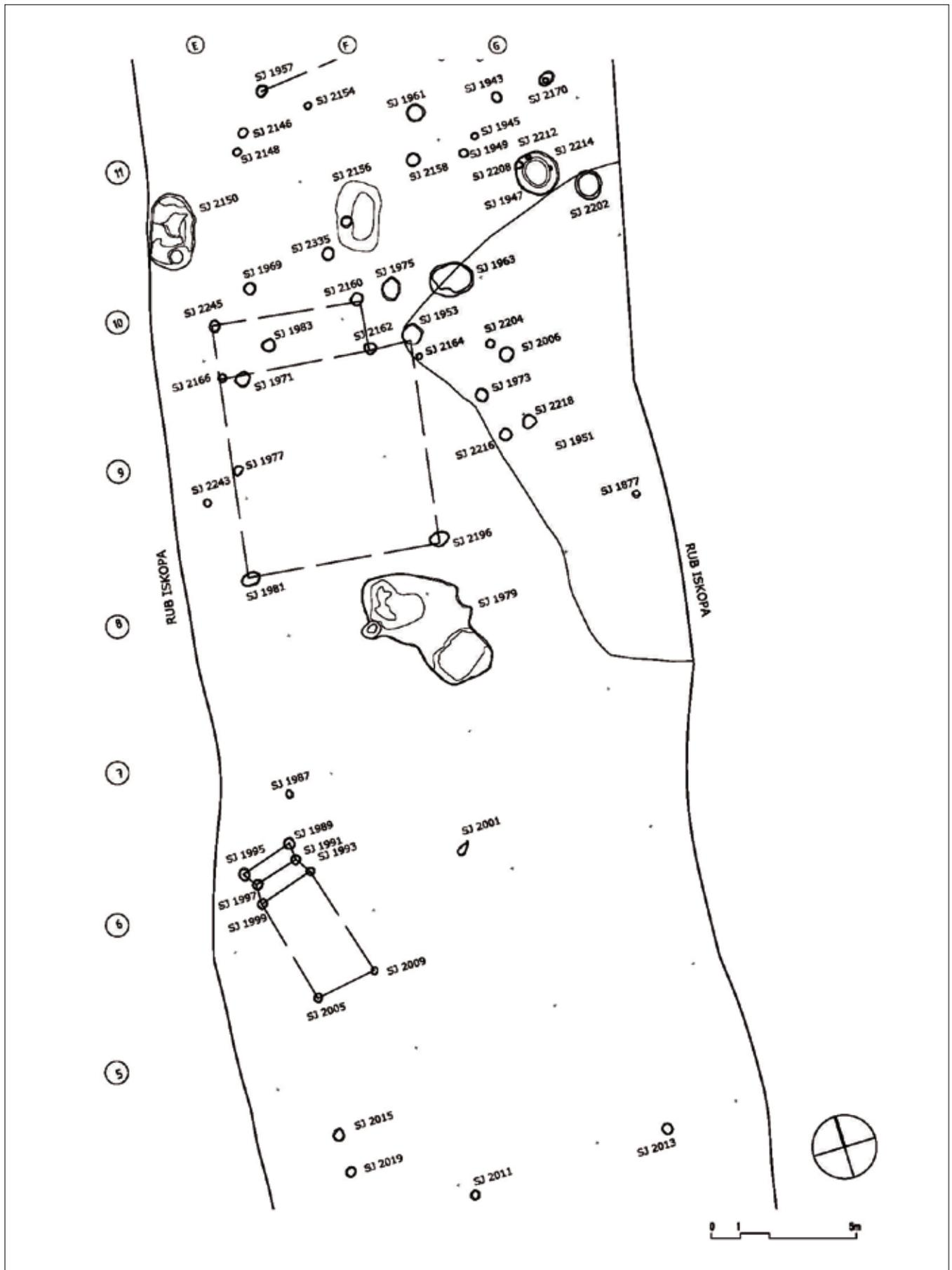

Sl. 11 Tlocrt južnog dijela lokaliteta od sjevera prema jugu 6/7  
 Fig. 11 Layout of the southern part of the site, from the north to the south 6/7

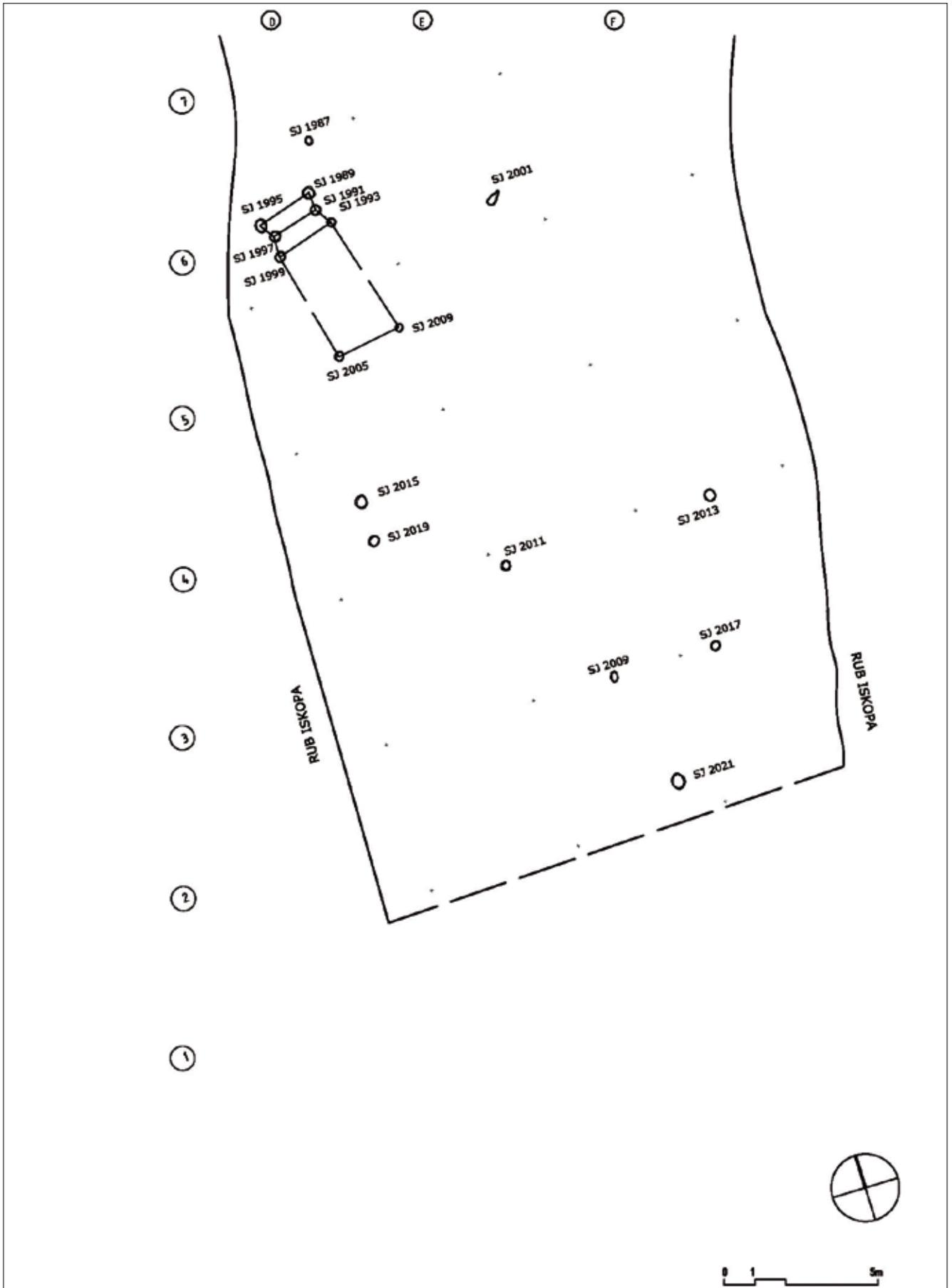

Sl. 12 Tlocrt južnog dijela lokaliteta od sjevera prema jugu 7/7

Fig. 12 Layout of the southern part of the site, from the north to the south 7/7



### 2.3.1. ARHEOLOŠKI KOMPLEKSI

#### Kompleks 1

Prvi kompleks se sastoji od niza jama i objekata te strukture za pripremu hrane: SJ 004/005/+006/031,<sup>1</sup> 007/008, 009/010, 011/012, 013/014, 015/016, 017/018, 021/022, 023/024, 025/026, 027/028, 032/033, 034/035, 036/037, 038/039, 040/041, 042/043, 044/045, 046/047, 050/051, 052/053, 062/063, 064/065, 066/067, 068/069, 070/071, 072/073, 180/181, 128/129, 216/217, 218/219, 248/249 (sl. 5, 13–14)

#### SJ 004/005+006/031 (sl. 14–20)

□ O 32, S–VI<sup>2</sup>

▼ 117,54–117,08

Dimenzije: 1,20 x 1,11 m

*Struktura za pripremu hrane*

Ukop SJ 005 pravokutnog je oblika zaobljenih krajeva. Zapuna SJ 004 je crna zemlja s garom uočena na visini od 117,54 i dnom na 117,49 m. Nalazila se na vrhu ukopa SJ 005 i oko nakupine nabijenog lijepa SJ 006 smještenog u njegovom središnjem dijelu. Riječ je o većim nabijenim komadima lijepa i keramike. U rasporedu lijepa SJ 006 uočeno je da tvori nepravilni četverokut (sl. 16, 19). U središnjem dijelu nalazi se manja koncentracija lijepa. Oko strukture s lijepom, nagorena je keramika grube strukture i zapečena zemlja. U SJ 006 nalaze se pravokutni komadi lijepa, ispod kojih je nađen 36 cm debeli sloj ugljena i gara SJ 031.

U zapunama ukopa SJ 005 pronađeni su ostaci ječma, prosa, drugih žitarica te šljive (vidi poglavlje 5.2, tablica 8/I dio). Prikupljen je velik broj ulomaka keramike lokalne proizvodnje (VKJ 2)<sup>3</sup> u svim zapunama, a od uvezenog posuđa jedan ulomak sigilate (T. 1: 3). Pronađeni su ulomci lonaca L5 (T. 1: 1) i poklopca P1 (T. 1: 2) te lonci tip L1, L2, L3 i L4.<sup>4</sup>

Ovaj ukop predstavlja ostatke strukture za pripremu hrane. Sastojao se od jame iznad koje je bila sagrađena struktura čije je urušenje pronađeno u najvišoj zapuni. Ulomci strukture su brojni, ali nedovoljno očuvani da bi se omogućila njihova točna rekonstrukcija. Vjerojatno se sastojala od jame iznad koje je bila sagrađena struktura od blata i pruća, moguće s ravnom plohom (kao u slučaju SJ 630/631 – kompleks 9). Sama jama nema zapečene stijenke te se zbog toga pretpostavlja da se u njoj nije ložilo, već se samo odlagao pepeo.

1 Prvi broj označava zapunu, drugi ukop, brojevi nakon znaka + označavaju brojeve drugih zapuna ili struktura u istom ukopu. Dio arheoloških kompleksa je u prihvaćen za objavu u radu Collegium Antropologicum (Šošćarić et al.). U tom su radu kompleksi označeni slovima radi uredničkih normi, a isključeni su kompleksi koji nemaju ostataka biljaka i životinjskih kostiju. Ovdje se donose svi kompleksi.

2 □ označava kvadrant, a S sektor.

3 Strukture su detaljno opisane u poglavlju 3.2.

4 Tipološka obrada nalaza slijedi u poglavlju 3.3.1.

### 2.3.1. ARCHAEOLOGICAL COMPLEXES

#### Complex 1

The first complex consists of a series of pits and buildings and a structure for food preparation: SJ 004/005/+006/031,<sup>1</sup> 007/008, 009/010, 011/012, 013/014, 015/016, 017/018, 021/022, 023/024, 025/026, 027/028, 032/033, 034/035, 036/037, 038/039, 040/041, 042/043, 044/045, 046/047, 050/051, 052/053, 062/063, 064/065, 066/067, 068/069, 070/071, 072/073, 180/181, 128/129, 216/217, 218/219, 248/249 (fig. 5, 13–14)

#### SU 004/005+006/031 (fig. 14–20)

□ O 32, A–VI<sup>2</sup>

▼ 117.54–117.08

Dimensions: 1.20 x 1.11 m

*Structure for food preparation*

The cut SU 005 is rectangular in shape, with rounded corners. Backfill SU 004 is black earth with soot observed at a height of 117.54 and with the end at 117.49 m. It was on top of the cut SU 005 and around the clusters of compact daub SU 006 located in its central part. Pieces of daub and ceramics are large and compact. It has been noticed that the diffusion of daub SU 006 forms an irregular quadrangle (fig. 16, 19). In the central part there is a smaller concentration of daub. Around the structure with daub, there are burned coarse ceramics and baked earth. In SU 006, rectangular pieces of daub were found and beneath that a 36 cm thick layer of coal and soot SU 031.

In backfills of cut SU 005 remains of barley, millet, other grains and prunes were found (see chapter 5.2, Table 8 / part I). A large number of fragments of locally produced pottery (VKJ 2)<sup>3</sup> was collected in all of the backfills, as well as one fragment of *sigillata* belonging to imported tableware (Pl. 1: 3). Fragments of pots L5 (Pl. 1: 1) and lids P1 (Pl. 1: 2), as well as pots of the L1, L2, L3 and L4 type were found.<sup>4</sup>

This cut represents the remains of the structure for food preparation. It consisted of a pit above which a structure was built whose ruins were found in the top backfill. Fragments of the structure are numerous, but not well enough preserved to allow their exact reconstruction. The structure probably consisted of a pit above which the structure of mud and twigs was built, possibly with a flat surface (as in the case of SU 630/631 – complex 9). The pit alone has no scorched walls and therefore it is assumed that it was not used for firing, but only for the disposal of ashes.

1 The first number indicates the backfill, the second one indicates the cut, the numbers following the + sign denote numbers of other backfills or structures in the same cut.

2 □ indicates the quadrant and the letter A indicates the area.

3 Fabrics are described in detail in section 3.2.

4 Typological interpretation of the findings follows in section 3.3.1



Sl. 13 Pogled iz zraka na kompleks 1  
Fig. 13 Aerial view of complex 1

**SJ 007/008** (sl. 14, 21–22)

□ P 31/32, S–VI

▼ 117,49–117,35 m

Dimenzije: 5,64 x 1,49 m

*Objekt/kanal nejasne namjene*

Zapuna SJ 007 je svijetlo sive boje s mrvicama ugljena i ulomcima keramike. Veća koncentracija nalaza uočena je na sjevernom dijelu zapune. Kanal je očuvan vrlo plitko, a na dnu su uočeni stupovi SJ 062/063, 070/071 i 072/173.

Ulomci pronađene keramike pripadaju isključivo lokalno proizvedenom posuđu (VKJ 2). Po dataciji se izdvaja ulomak glaziranog tarionika iz 3. i 4. st. (T. 2: 10) dok se ostala keramika (T. 1: 4–9) datira od 1.–4. st. Prisutni su tipovi lonaca L3 (T. 1: 4), L4 (T. 1: 5–6), tanjur T1 (T. 1: 7) i poklopac P2 (T. 1: 8–9).

Arheološke cjeline poput SJ 007/008 izduljenog oblika, interpretiraju se u literaturi (Gabler 1982) kao ukopi u koje su bili položeni temelji za zidove nadzemnih objekata. U zapuni su pronađeni ostaci lijepa koji je mogao pripadati zidovima tog objekta.

**SU 007/008** (fig. 14, 21–22)

□ P 31/32, A–VI

▼ 117,49–117,35 m

Dimensions: 5.64 x 1.49 m

*Structure/channel of undetermined purpose*

Backfill SU 007 is of light gray colour with a hint of coal and fragments of pottery. A higher concentration of findings has been noticed in the northern part of the backfill. The channel is preserved to a small depth, and postholes SU 062/063, 070/071 and 072/073 were observed at its bottom.

Fragments of retrieved pottery belong exclusively to locally produced dishes (VKJ 2). A fragment of a glazed mortar was dated, exceptionally, from the 3<sup>rd</sup> to the 4<sup>th</sup> century (Pl. 2: 10), while other ceramics (Pl. 1: 4–9) date from the 1<sup>st</sup> to the 4<sup>th</sup> century. Also present are pots of L3 (Pl. 1: 4) and L4 (Pl. 1: 5–6) type, a plate of T1 (Pl. 1: 7) type and a lid of P2 type (Pl 1: 8–9).

Archaeological units of elongated shape, such as SU 007/008, are interpreted in the literature (Gabler 1982)





Sl. 15 Zapuna SJ 004 u ukopu SJ 005  
Fig. 15 Backfill SU 004 within the cut SU 005



Sl. 16 Zapune SJ 004 i 006 u ukopu SJ 005  
Fig. 16 Backfills SU 004 and 006 within the cut SU 005



Sl. 17 Presjek ukopa SJ 005  
Fig. 17 Cross-section of cut SU 005

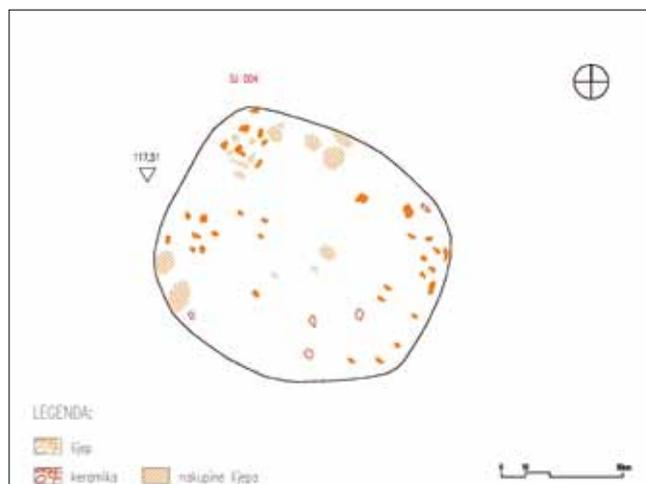

Sl. 18 Tlocrt zapune SJ 004  
Fig. 18 Layout of backfill SU 004

### SJ 013/014, (sl. 14, 23, 25, T. 2: 1–3)

□ P 32/33, S–VI

▼ 117,44–116,57

Dimenzije: 2,80 x 1,90 m

Spremište?

Zapuna SJ 013 nepravilna je oblika, pepeljaste, sive boje s nakupinama ugljena i mrvicama lijepa. Povezana je sa stupovima SJ 040/041, 042/043, 044/045, 046/047.

U zapuni je pronađen ulomak drške staklenog vrča (vidi poglavlje 4.1, kat. br. 1) (T. 2: 3). Keramičko je posuđe lokalne proizvodnje. Veći dio posuda pripada strukturi VKJ 2 i nešto manje kasnoantičkoj strukturi VKJ 29. Nekolicina ulomaka nije izdvojena u zasebne strukture jer se radi o pojedinačnim nalazima: ulomak sivo pečene keramike sa crnim premazom (*Pannonische Glanzton Ware*) koji je presitan za detaljno definiranje i ulomak crveno pečene keramike pročišćene strukture VKJ 9 (3. st.). Pronađen je lonac L4 (3.–5. st.) (T. 2: 1), strukture VKJ 2 i L8 (T. 2: 2) strukture VKJ

as cuts in which the foundations for the walls of above-ground structures had been laid. Remains of daub were found in the backfill that could be a part of the walls of this structure.

### SU 013/014, (fig. 14, 23, 25, Pl. 2: 1–3)

□ P 32/33, A–VI

▼ 117,44–116,57

Dimensions: 2.80 x 1.90 m

Storage?

Backfill SU 013 has an irregular form, ashen gray colour, with clusters of coal and crumbs of daub. It is linked to postholes SU 040/041, 042/043, 044/045, 046/047.

A fragment of a handle of a glass jug was found in the backfill (see chapter 4.1, Cat. No. 1) (Pl. 2: 3). Ceramic pottery was locally produced. Most of the vessels are made of fabric VKJ 2 and the rest of fabric VKJ 29 from the late Antiquity. Several fragments have not been divided into se-

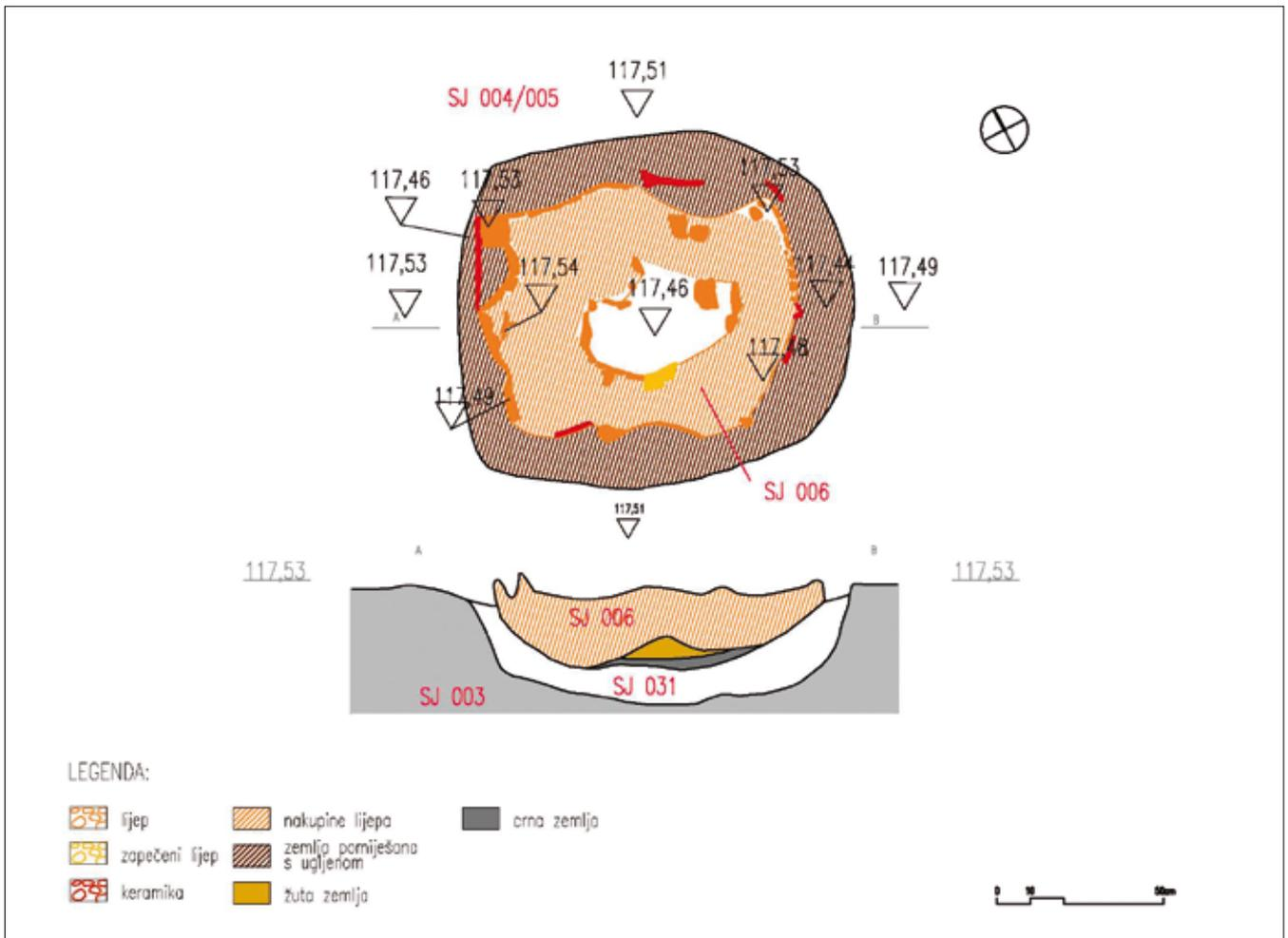

Sl. 19 Tlocrt i presjek zapuna u ukopu SJ 005  
Fig. 19 Layout and cross-section of the backfill in cut SU 005

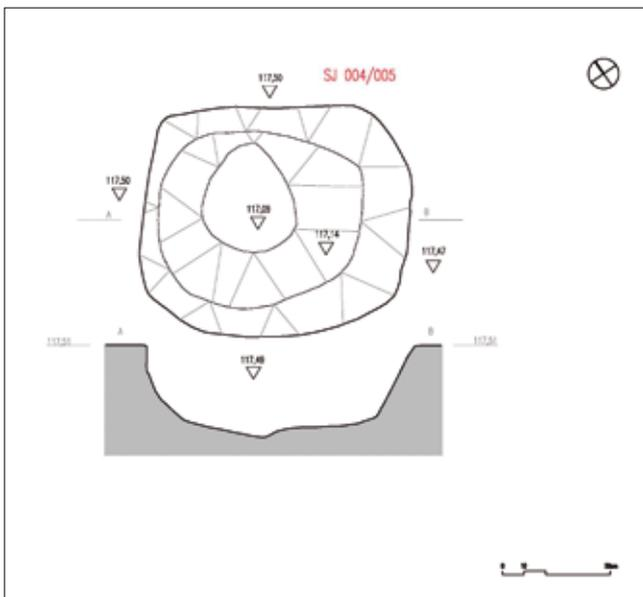

Sl. 20 Tlocrt ukopa SJ 005  
Fig. 20 Layout of cut SU 005

parate fabrics because they are individual finds, i.e.: a fragment of gray fired ceramics with black slip (*Pannonische Glanzton Ware*), which is too small for a detailed definition and a fragment of red fired ceramics of purified fabric VKJ 9 (3<sup>rd</sup> c.). A pot L4 (3<sup>rd</sup>-5<sup>th</sup> c.) (Pl. 2: 1) of fabric VKJ 2 and one L8 (Pl. 2: 2) of fabric VKJ 29 were also found. Remains of bread wheat and blackberries were found in the backfill (see chapter 5.2., Table 8 / part I).

Cut SU 013/014 was probably covered by a roof built of thin beams, some of which might have had a support in postholes located on the west side, and of wicker or straw with a coating of mud which is indicated by the finding of daub in the backfill. This cut is too small for a residential building, so it is possible that it was used for performing work activities or as a food storage as suggested by the finding of plant residues.

**SU 015/016**, (fig. 14, 24–25, Pl. 2: 4)

□ Q 33; A–VI

▼ 117.40–116.86 m

Dimensions: 2.84 x 1.37 m

Storage?





29. U zapuni su pronađeni ostaci krušne pšenice i kupina (vidi poglavlje 5.2., tablica 8 / I dio).

Ukop SJ 013/014 vjerojatno je bio natkriven krovom od tankih greda, od kojih neke imaju uporište u pronađenim stupovima smještenim sa zapadne strane, i šiblja ili slame s premazom od blata na što ukazuje nalaz lijepa u zapuni. Ovaj ukop premali je da bi mogao poslužiti kao stambeni objekt, stoga je moguće da je bio korišten za obavljanje radnih aktivnosti ili kao spremište namirnica na što upućuje nalaz biljnih ostataka.

**SJ 015/016**, (sl. 14, 24–25, T. 2: 4)

□ Q 33; S–VI

▼ 117,40–116,86 m

Dimenzije: 2,84 x 1,37 m

*Spremište?*

Zapuna pravokutnog oblika zaobljenih krajeva, svijetlo sive, pepeljaste boje. Dno središnjeg dijela ukopa bilo je izdignuto.

Pronađen je ulomak tanjura sa zaobljenim i zadebljanim rubom s unutrašnje strane izrađen od pročišćene gline s tragovima crvenog premaza kakvi su česti u Panoniji 1.–4. st. (T. 2: 4), strukture VKJ 13. Svojom oblikom odgovara tanjurima T2 tipa lokalne proizvodnje. U zapuni su pronađeni ulomci keramike lokalne izrade, strukture VKJ 29 (3.–5. st.), VKJ 2, VKJ 11 te VKJ 16 kojoj pripada samo nekoliko manjih ulomaka.

Ovaj je objekt relativno malen i dubok, a silazak u njega čini se dosta nespretnim zbog čega nije bio pogodan za stanovanje i vjerojatno je imao neku drugu svrhu: prostor za rad ili spremanje.

**SJ 025/026**, (sl. 14, 26–27, T. 2: 5–14)

□ N/O 33, S–VI

▼ 117,50–117,07

Dimenzije: 3,96 x 1,39 m

*Jama*

Zapuna svijetlo sive boje, nepravilnog, izduljenog oblika u kojoj je pronađena antička keramika, nešto ulomaka lijepa i tragovi ugljena.

Pronađeno je više lonaca tipa L1 (T. 2: 5–6) VKJ 2 strukture i dna posuda za kuhanje s tragovima gara iste strukture (T. 2: 9, 11). Pronađen je i ulomak lonca ili vrča (T. 2: 12) panonske sive keramike (nedefinirane strukture) i ulomak tanjura pročišćene strukture VKJ 13 s crvenim premazom (T. 2: 13) koji se datira od 1.–4. st., analogan T2 lokalnim tanjurima. Pronađen je i P 2 (VKJ 2 strukture) datiran od 1.–4. st. (T. 2: 8). Ova je jama presjekla jamu SJ 032/033, a mogla je služiti za spremanje.

**SJ 027/028**, (sl. 14, 28)

□ Q 32, S–VI

▼ 117,42–117,29

Dimenzije: 1,87 x 1,34 m



Sl. 21 Pogled s juga na SJ 007/008 i SJ 052/053

Fig. 21 View of SU 007/008 and SU 052/053 from the south

Backfill of a rectangular shape with rounded corners, light gray, ashen colour. The bottom of the central part of the cut was elevated.

A fragment of a plate was found, with rounded and thickened rim, with the inner side made from refined clay with traces of red slip, typical of Pannonia from the 1<sup>st</sup> – the 4<sup>th</sup> century (Pl. 2: 4), made of fabric VKJ 13. Its shape fits locally produced plates of T2 type. In the backfill, locally produced pottery made of fabric VKJ 29 were found (3<sup>rd</sup>–5<sup>th</sup> c.), as well as few small fragments made of VKJ 2, VKJ 11 and 16 VKJ fabric.

This property is relatively small and deep, and the descent into it seems to be quite cumbersome due to which it was not suited for habitation and probably had been used for some other purpose such as workshop or a storage.

**SU 025/026**, (fig. 14, 26–27, Pl. 2: 5–14)

□ N/O 33, A–VI

▼ 117,50–117,07

Dimensions: 3.96 x 1.39 m

*Pit*

A light gray backfill of irregular, elongated shape, in which antique ceramics were found, alongside with some daub fragments and traces of coal.

Several pots of L1 type (Pl. 2: 5–6) made of VKJ 2 fabric were found and few bases of cooking vessels with traces of soot made of the same fabric (Pl. 2: 9, 11). A fragment of

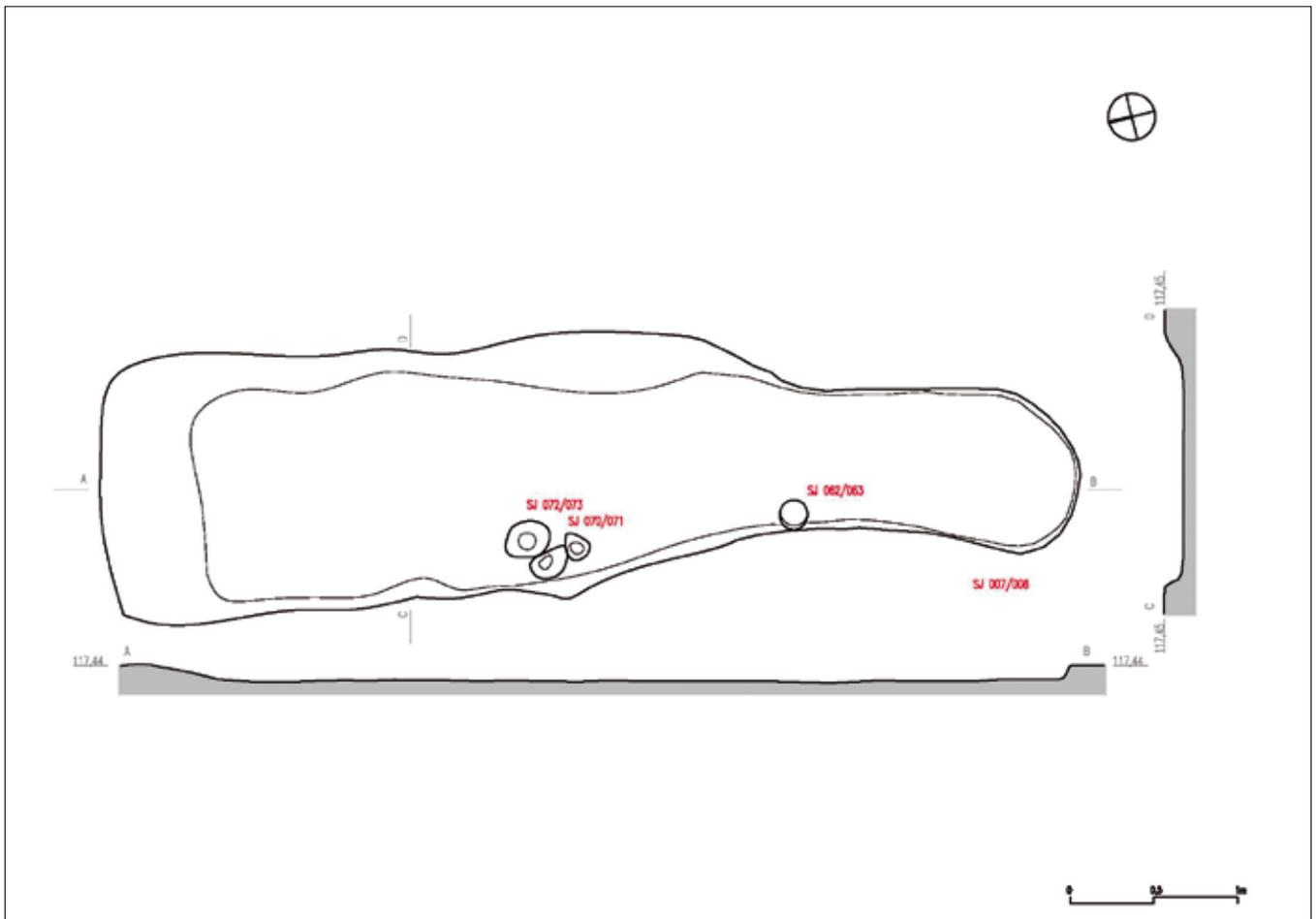

Sl. 22 Tlocrt ukopa SJ 007/008 i stupova pronađenih na dnu  
 Fig. 22 Layout of the cut SU 007/008 and postholes found at the bottom

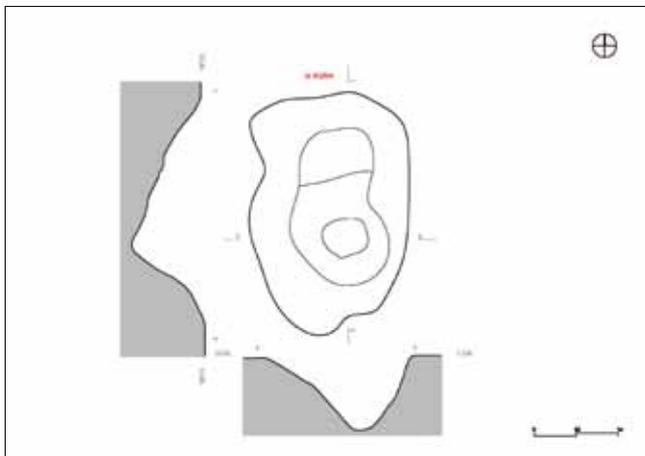

Sl. 23 Tlocrt ukopa SJ 013/014  
 Fig. 23 Layout of the cut SU 013/014

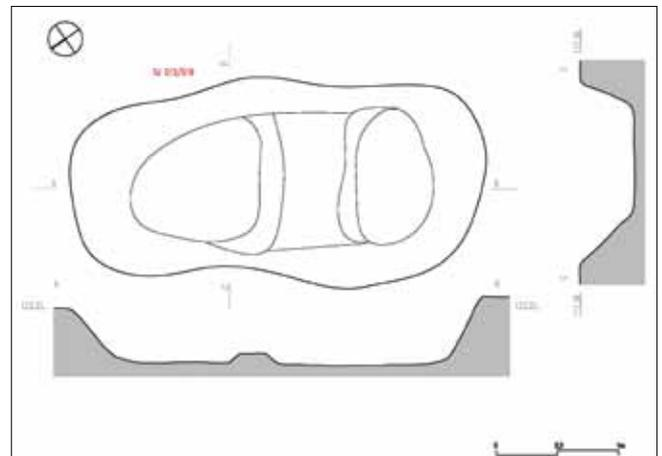

Sl. 24 Tlocrt ukopa SJ 015/016  
 Fig. 24 Layout of the cut SU 015/016

### Jama

Plitka zapuna sive boje, ovalnog oblika. Povezana je sa stupom SJ 248/249 u kojemu su pronađeni ulomci keramike VKJ 29, kasnoantičke strukture. Nalazi keramike malobrojni su i jako usitnjeni.

a pot or a jug (Pl. 2: 12) made of the Pannonian gray ware (undefined fabric) was found as well as a fragment of a plate made of purified fabric VKJ 13 with a red slip (Pl. 2: 13), which dates from the 1<sup>st</sup> to the 4<sup>th</sup> century, analogous to local plates T2. A P2 pot was found (VKJ 2 fabric) dated from the 1<sup>st</sup> to the 4<sup>th</sup> century (Pl. 2: 8). This pit cuts through the



Sl. 25 Pogled iz zraka na SJ 013/014 (sredina) i SJ 015/016 (gore lijevo)

Fig. 25 Aerial view of SU 013/014 (middle) and SU 015/016 (top left)

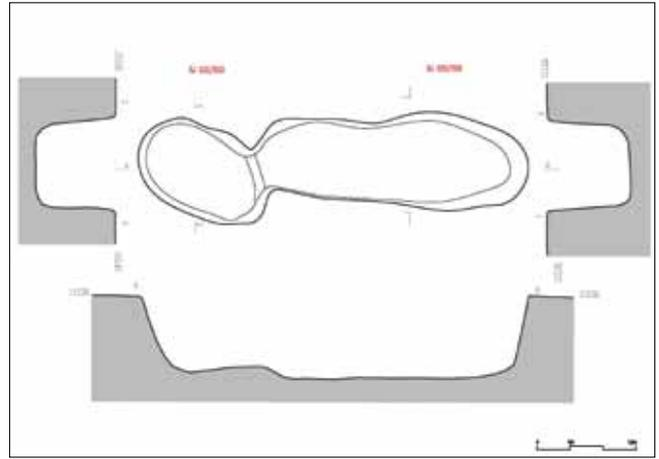

Sl. 26 Tlocrt ukopa SJ 032/033 (lijevo) i SJ 025/026 (desno)

Fig. 26 Layout of the pit SU 032/033 (left) and SU 025/026 (right)



Sl. 27 Ukopi SJ 032/033 (sredina prednji plan), SJ 025/026 i SJ 034/035 (gore, desno)

Fig. 27 Cuts SU 032/033 (middle foreground), SU 025/026 and SU 034/035 (top, right)

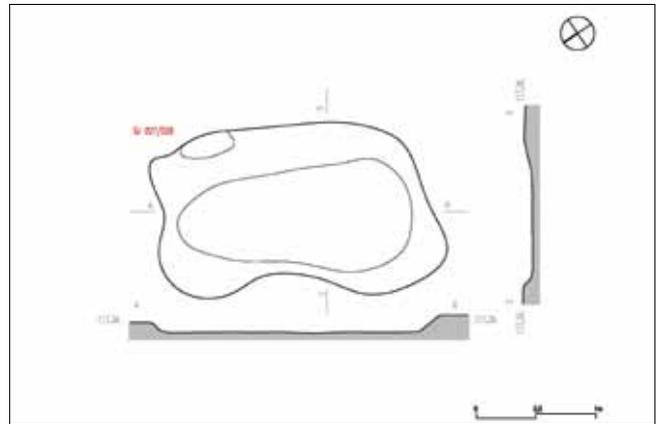

Sl. 28 Tlocrt ukopa SJ 027/028

Fig. 28 Layout of the cut SU 027/028

### SJ 032/033, (sl. 14, 27)

□ N 33, S–VI

▼ 117,49–116,99

Dimenzije: 2,14 x 1,35 m

Jama

Pjeskovita zapuna nepravilnog kružnog oblika svijetlosive boje s mrvicama gara i lijepa. Presječena je na istočnoj strani sa SJ 025/026.

### SJ 034/035, (sl. 14, 27, 29–30, T3)

□ N/O 33, S–VI

▼ 117,50–116,99

Dimenzije: 1,86 x 0,89 m

Jama

Zapuna nepravilnog oblika svijetlo smeđe boje u kojoj su pronađeni tragovi gara i lijepa.

Na dubini 117,13 m pronađen je donji dio velike posude za pohranu namirnica ukopan u zdravicu (T. 3), VKJ 2 strukture. Zapuna posude u potpunosti je flotirana i ana-

pit SU 032/033, and it could have been used for storage.

### SU 027/028, (fig. 14, 28)

□ Q 32, A–VI

▼ 117,42–117,29

Dimensions: 1.87 x 1.34 m

Pit

Shallow gray coloured backfill, oval in shape. It is connected with a posthole SU 248/249 in which fragments of VKJ 29 ceramics from the late Antiquity were found.

### SU 032/033, (fig. 14, 27)

□ N 33, A–VI

▼ 117,49–116,99

Dimensions: 2.14 x 1.35 m

Pit

Sandy backfill of an irregular round shape, light gray coloured with crumbles of soot and daub. It is cut through on the east side by SU 025/026.

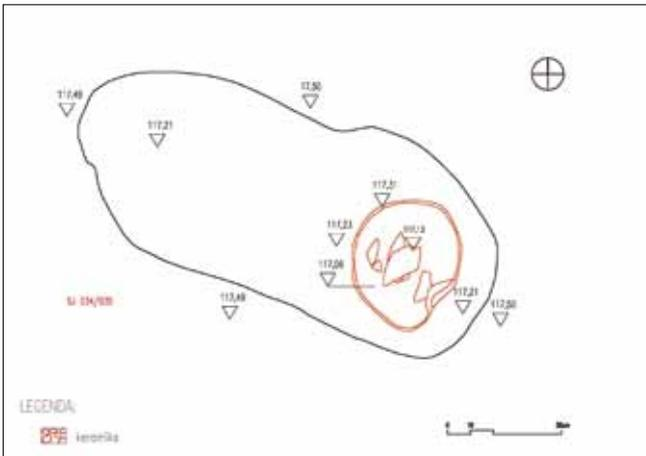

Sl. 29 Tlocrt ukopa SJ 034/035 s posudom za spremanje hrane *in situ*  
 Fig. 29 Layout of the cut SU 034/035 with a vessel for food storage *in situ*

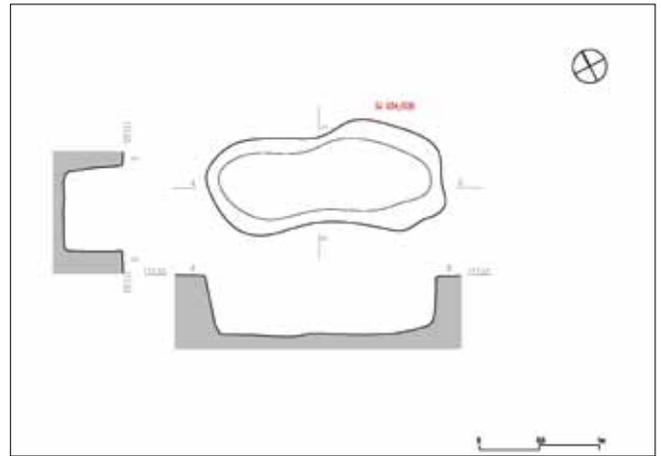

Sl. 30 Tlocrt ukopa SJ 034/035  
 Fig. 30 Layout of the cut SU 034/035

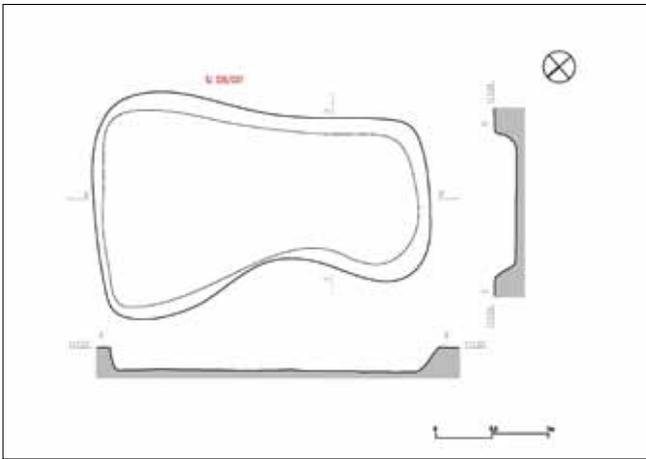

Sl. 31 Tlocrt ukopa SJ 036/037  
 Fig. 31 Layout of the cut SU 036/037

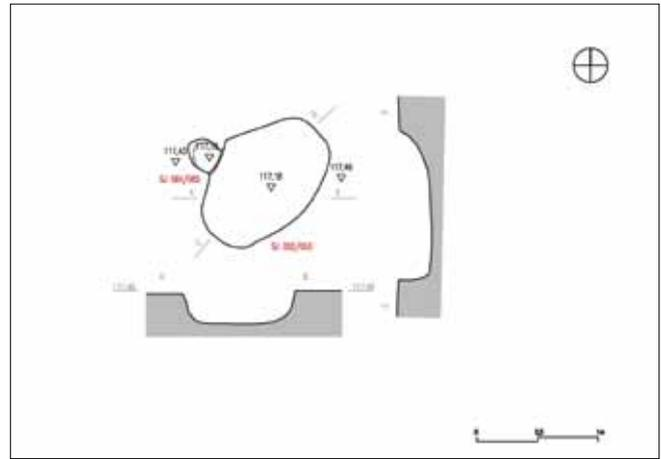

Sl. 32 Ukop SJ 052/053  
 Fig. 32 Cut SU 052/053

lizirana, te su prepoznati ostaci žitarica (vidi poglavlje 5.2, Tablica 8 / II dio). Pored lonca za pohranu hrane pronađeni su ulomci keramike VKJ 2 strukture druge posude.

Ova cjelina služila je kao jama za pohranu namirnica.

#### **SJ 036/037**, (sl. 14, 31)

□ O 33/32; S–VI

▼ 117,54–117,31

Dimenzije: 2,98 x 1,72 m

*Jama*

Plitka jama sa stupom, zapune svijetlo smeđe boje, nejasne namjene.

#### **SJ 052/053**, (sl. 14, 21, 32–33, T. 2: 14)

□ P 31; S–VI;

▼ 117,4–117,18 m;

Dimenzije: 1,24 x 0,73 m

*Jama*

Zapuna smeđe boje nepravilna oblika s mrvicama

#### **SU 034/035**, (fig. 14, 27, 29–30, Pl. 3)

□ N/O 33, A–VI

▼ 117.50–116.99

Dimensions: 1.86 x 0.89 m

*Pit*

Irregularly shaped light brown backfill in which traces of soot and daub were found.

At the depth of 117.13 m, the lower part of a large container for food storage made of VKJ 2 fabric was found buried in a sterile soil (Pl. 3). Backfill of the vessel was fully flotated and analyzed, and the remains of cereals were identified (see chapter 5.2, Table 8 / part II). Alongside of the pot for food storage, fragments of other vessel made of VKJ 2 fabric were found.

This unit was used as a pit for food storage.

#### **SU 036/037**, (fig. 14, 31)

□ O 33/32; A–VI

▼ 117.54–117.31



ugljena i keramike. Nalazi se jugoistočno od SJ 007/008 (T. 2: 14), uz stup SJ 064/065.

U zapuni su se nalazili tragovi lijepa i gara te jako usitnjene keramike, kasnoantičke perle od crnog stakla od kojih su neke poluproizvod (poglavlje 4.2). U Panoniji je nakit od crnog stakla čest. Stanje objavljenosti možda upućuje na drukčiji zaključak, ali uvid u muzejske depoe, daje potpuno novu sliku. Upravo zbog toga, proizvodnja takvog nakita u Panoniji (to već znači više mjesta) ne može se isključiti.

Nalaz poluproizvoda na Kiškoriji ne govori odmah o proizvodnji nakita na ovom mjestu, jer bi za to morali postojati i neki drugi čimbenici. Pored ovih perli od crnog stakla, pronađene su i dvije perle crvene boje. Mjesto u zapuni gdje su bile perle bilo je znatno rahlije od ostatka zapune. Pronađene su i vrlo usitnjene životinjske kosti koje se ne mogu pobliže definirati (Vidi poglavlje 5.1, tablica 5)

#### SJ 216/217, (sl. 14, 34)

□ P/Q 31; S–VI

▼ 117,44–117,32 m

Dimenzije: 1,57 x 0,80 m

Jama

Svijetlo siva zemlja s garom, lijepom i keramikom. Nalazi se istočno od SJ 007/008.

#### SJ 218/219, (sl. 14, 35)

□ P 32, S–VI

▼ 119,31–119,10

Dimenzije: 1,33 x 1,02 m

Jama

Zapuna sive boje s malo lijepa. Nalazi se zapadno od SJ 007/008.

U prvom kompleksu arheoloških cjelina nalazi se i nekoliko stupova koji su mogli činiti nadzemni objekt (sl. 14). Ostale cjeline iz ovog kompleksa još su manje od gore prikazanih i većinu čine stupovi s vrlo usitnjenim keramičkim

Dimensions: 2.98 x 1.72 m

Pit

Shallow pit with a posthole and light brown backfill; undetermined purpose.

#### SU 052/053, (fig. 14, 21, 32–33, Pl. 2: 14)

□ P 31; A–VI;

▼ 117.4–117.18 m;

Dimensions: 1.24 x 0.73 m

Pit

Irregularly shaped brown backfill with crumbles of coal and pottery. It is located southeast from SU 007/008 (Pl. 2: 14), next to posthole SU 064/065.

The backfill contained traces of soot and daub and very fragmented pottery, late antique black glass beads, some of which are semi-finished (chapter 4.2). Jewellery made of black glass is widespread in Pannonia. State of publication may refer to a different conclusion, but an insight into the museum storerooms, shows a completely new picture. Because of this, the production of such jewellery in Pannonia (meaning on more than one location) cannot be excluded.

Findings of semi-finished products at Kiškorija does not necessarily indicate the production of jewellery on this location, because some other factors would have to be present. In addition to these black glass beads, two red beads were found. Position within the backfill where they were found was much softer than the rest of it. Very fragmented animal bones that cannot be closely defined were also found (see chapter 5.1, table 5).

#### SU 216/217, (fig. 14, 34)

□ P/Q 31; A–VI

▼ 117.44–117.32 m

Dimensions: 1.57 x 0.80 m

Pit

Light gray earth with soot, daub and pottery. Located east of SU 007/008.



Sl. 33 Ukop SJ 052/053  
Fig. 33 Cut SU 052/053

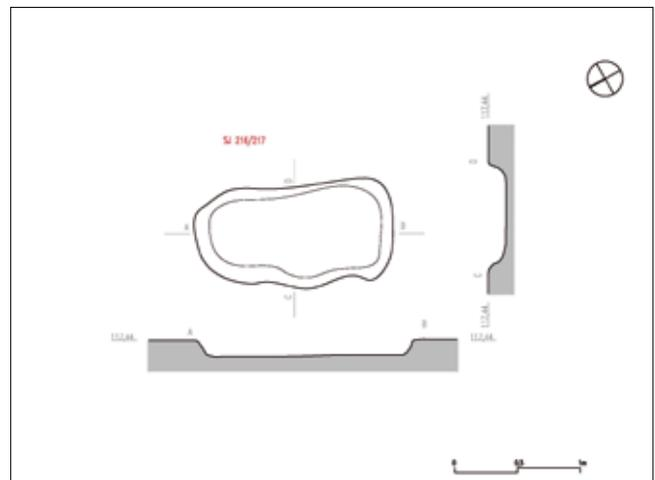

Sl. 34 Ukop SJ 216/217  
Fig. 34 Cut SU 216/217



nalazima ili mrvicama lijepa i gara koje nije moguće sigurno interpretirati. Vjerojatno su činili dio ograde ili nadzemnog objekta kojeg nije moguće prepoznati. Pretpostavlja se da je kanal SJ 007/008 negativ temelja zida kuće od drva i lijepa, a drugi ukopi čine radne prostore, otpadne jame i spremnice. Izvan objekta nalazila se i struktura za pripremu hrane unutar koje su pronađeni urušeni elementi njeke konstrukcije, posuđe i ostaci biljaka.

Većina nalaza koji su pronađeni u ovom kompleksu (T. 1–3) široko se datiraju, od 1.–4. st. Nešto užu dataciju pruža dno tarionika sa zeleno maslinastom glazurom iz 3.–4. st. (SJ 007/008) i lonac s dvije ručke L5 (SJ 004/005/031/005) te L8 (SJ 013/014). Struktura lonca L8 je VKJ 29 što također govori o dataciji u 3.–4. st.

### Kompleks 2 (sl. 5, 36, T. 4–8)

Drugi kompleks sastoji se od kolibe koju čine stupovi i duguljaste jame, te od ostataka ognjišta i ukopa nejasne namjene.

#### Koliba

**SJ 096/097, SJ 110/111, 112/113, 114/115, 120/121, 132/133, 134/135, 136/137, 138/139, 140/141, 144/145, 362/363, 538/539, 540/541** (sl. 5, 10, T. 4–7)

□ V/W/X 27/28/29, S–VI

Dimenzije: 6,8 m, s nadstrešnicom 8 m, širina 6,3 m

#### SJ 110/111, (sl. 36–37)

□ W 28; S–VI

▼ 117,10–117,00 m

Dimenzije: 2,65 x 0,60 m

*Ukop za polaganje temelja kolibe*

Zapuna sive boje, izduljenog oblika čiji je ukop mogao služiti za polaganje temelja. S desne se strane nalazi stup SJ 138/139, pronađen na dnu ukopa. SJ 110/111 presječen je ukopom SJ 108/109 koji pripada kompleksu 3.

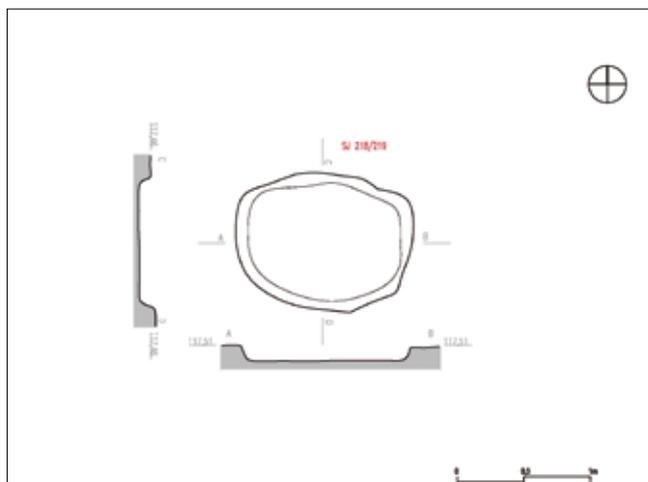

Sl. 35 Ukop SJ 218/219  
Fig. 35 Cut SU 218/219

#### SU 218/219, (fig. 14, 35)

□ P 32, A–VI

▼ 119.31–119.10

Dimensions: 1.33 x 1.02 m

*Pit*

Gray backfill with a hint of daub. Located west of SU 007/008.

In the first complex of archaeological units, there are several postholes which could have formed an above-ground object (fig. 14). Other units in this complex are even smaller than those shown above, and they mostly consist of postholes with finely triturated findings of pottery or crumbs of daub and soot which cannot be interpreted with certainty. They probably formed a part of the fence or of the over-ground structure which cannot be defined. It is assumed that the channel SU 007/008 is a negative of the foundations of the wall of the house made of wood and daub, while other cuts present workspaces, waste pits and storage rooms. Outside of the structure there was a facility for preparing food inside which collapsed elements of its construction were found, as well as the dishes and plant residues.

Most of the findings found in this complex (Pl. 1–3) can be roughly dated from the 1<sup>st</sup> to the 4<sup>th</sup> century. The base of a mortar with olive green glaze from 3<sup>rd</sup>–4<sup>th</sup> century provides a somewhat narrower dating (SU 007/008) as well as the pot with two handles L5 (SU 004/005/031/005) and L8 (SU 013/014). Fabric of the pot L8 is VKJ 29 which also affirms dating to the 3<sup>rd</sup>–4<sup>th</sup> century.

#### Complex 2 (fig. 5, 36, Pl. 4–8)

The second complex consists of a hut made of postholes and elongated pits, and of remains of the hearth and cuts of undetermined purpose.

#### Hut

**SU 096/097, SJ 110/111, 112/113, 114/115, 120/121, 132/133, 134/135, 136/137, 138/139, 140/141, 144/145, 362/363, 538/539, 540/541** (fig. 5, 10, Pl. 4–7)

□ V/W/X 27/28/29, A–VI

Dimensions: 6.8 m, with a canopy together with the shed, 8 m, width 6.3 m

#### SU 110/111, (fig. 36–37)

□ W 28; A VI

▼ 117.10–117.00 m

Dimensions: 2.65 x 0.60 m

*Cut for the foundations of the hut*

Gray backfill, of elongated form, a cut of which could have been used for laying of the foundation. On the right side there is a posthole SU 138/139, found at the bottom of the cut. SU 110/111 is cut through by the cut SU 108/109 which belongs to the complex 3.

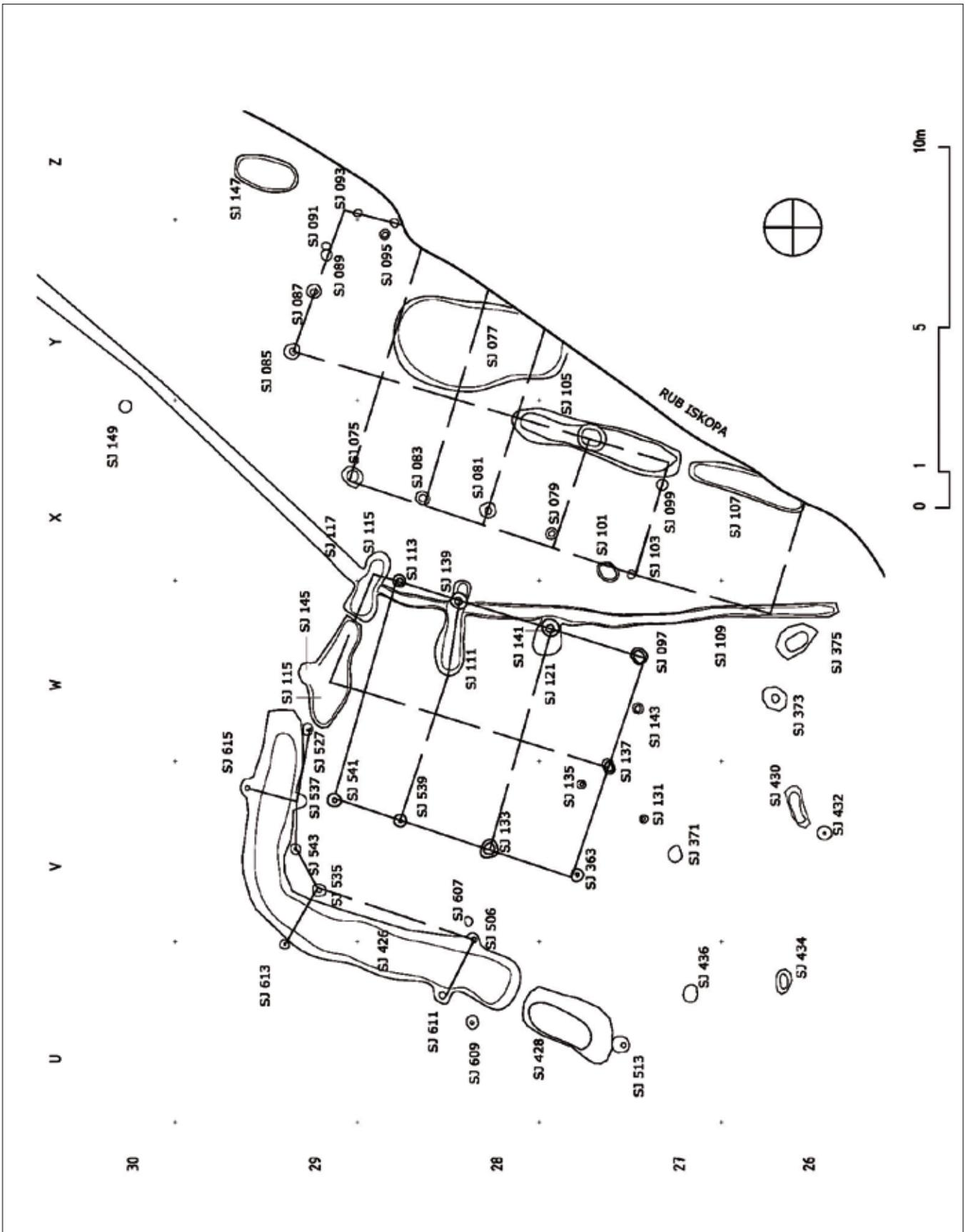

Sl. 36 Tlocrt istočnog dijela sektora VI i VII s kompleksima 2 i 3  
 Fig. 36 Layout of the eastern part of the Area VI and VII with complexes 2 and 3

**SJ 114/115**, (sl. 5, 36, 38, T. 4: 1–2)

- W/X 28; S–VI
- ▼ 117,16–116,95

Dimenzije: 3,25 x 1,40 m

*Ukop za polaganje temelja kolibe*

Zapuna nepravilnog izduženog oblika, sive boje. Sa sjeverne strane nađen je stup SJ 144/145 čija je zapuna po boji i sastavu bila ista kao SJ 114/115.

Među pronađenom keramikom može se izdvojiti lonac tipa L2 (T. 4: 1) i čep poklopca VKJ 2 strukture (T. 4: 2). Pronađeno je i nekoliko ulomaka veće nedefinirane posude VKJ 14 kasnoantičke strukture te amorfni ulomak željeza (vidi poglavlje 4.3, kat. br. 2). Unutar ove cjeline pronađeni su ostaci goveda (vidi poglavlje 5.1, tablica 5).

Ovaj je objekt kao i SJ 110/111 mogao služiti za polaganje grede odnosno za temeljenje zida.

**SJ 132/133**, (sl. 36)

- V 28; S–VI
- ▼ 117,06–116,89

$d = 0,56$  m

*Stup*

Zapadni stup kolibe sa zapunom sive boje. Pronađen je ulomak L8 lonca, VKJ 24 strukture.

**SJ 136/137**, (sl. 36)

- V 27; S–VI
- ▼ 117,20–116,89

Dimenzije: 0,40 x 0,26 m

*Stup*

Ovo je južni, središnji stup kolibe. U zapuni su pronađeni ulomci lijepa i nedefinirani keramički oblici, struktura VKJ 1 i 2.

**SJ 362/363**, (sl. 36)

- W 2; S–VI
  - ▼ 117,10–116,96 m
- $d = 0,39$  cm

**SU 114/115**, (fig. 5, 36, 38, Pl. 4: 1–2)

- W/X 28; A–VI
- ▼ 117,16–116,95

Dimensions: 3.25 x 1.40 m

*Cut for the foundations of the hut*

Irregular elongated gray backfill. On the north side a posthole SU 144/145 was found, with a backfill of same colour and composition as in SU 114/115.

Among the found ceramics, a pot L2 (Pl. 4: 1) and a lid handle of VKJ 2 fabric (Pl. 4: 2) can be distinguished. Several fragments of a larger undefined vessel of VKJ 14 late antique fabric was also found and an amorphous iron fragment (see chapter 4.3, Cat. No. 2). Inside this unit, the remains of a cow were discovered (see chapter 5.1, Table 5).

This structure, as well as SU 110/111, could have served for laying a beam, or a foundation of a wall.

**SU 132/133**, (fig. 36)

- V 28; A–VI
- ▼ 117,06–116,89

$d = 0.56$  m

*Posthole*

Western posthole of the hut with a gray backfill. A fragment of a pot L8 of VKJ 24 fabric found within it.

**SU 136/137**, (fig. 36)

- V 27; A–VI
- ▼ 117,20–116,89

Dimensions: 0.40 x 0.26 m

*Posthole*

This is the southern, central posthole of the hut. Fragments of daub and undefined ceramic shapes of VKJ 1 and 2 fabrics were discovered in the backfill.

**SU 362/363**, (fig. 36)

- W 2; A–VI
  - ▼ 117,10–116,96 m
- $d = 0.39$  cm

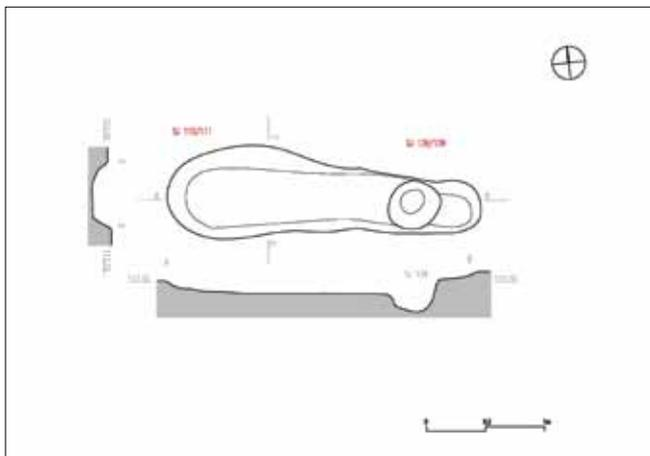

Sl. 37 Tlocrt ukopa SJ 110/111 sa stupom SJ 138/139  
Fig. 37 Layout of the cut SU 110/111 with a posthole SU 138/139

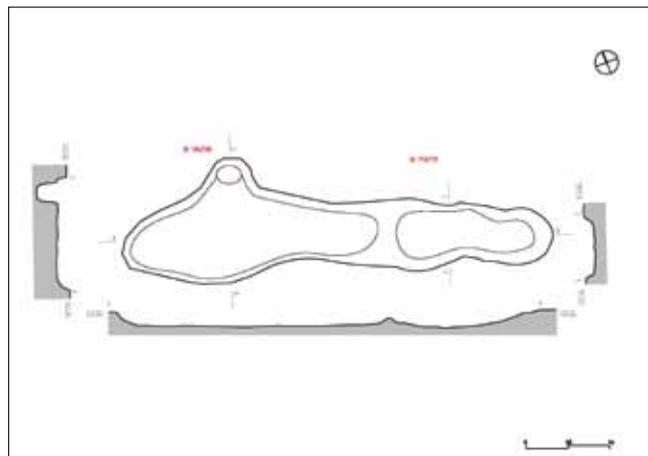

Sl. 38 Ukop SJ 114/115 i ukop stupa SJ 144/145  
Fig. 38 Cut SU 114/115 and a posthole cut SU 144/145





### Stup

Jugozapadni stup kolibe. Zapuna je sive, pepeljaste boje s ugljenom i lijepom te nekoliko ulomaka keramike.

Pronađeni lonac koso izvijenog oboda pripada strukturi VKJ 2 (T. 4: 3), a lonac tipa L8 (T. 4: 4) strukturi 1. Pronađeni su i sitni ulomci keramike struktura VKJ 1, VKJ 2 i VKJ 29.

Kolibu su činila 4 para bočnih stupova. Zbog širine objekta pretpostavlja se da su južni stup SJ 136/137 i sjeverni SJ 144/145 morali imati i odgovarajuće stupove u sredini kako bi objekt mogao nositi krovnu konstrukciju. Cje-line SJ 114/115, 110/111 i 120/121 su vjerojatno ostaci ukopa za temelje zidova.

Južno od kolibe nalaze se stupovi SJ 142/143, 370/371, 372/373, 429/430, 431/432, 433/434, 435/436 i jama SJ 374/375. Njihova funkcija nije u potpunosti jasna, jedna od mogućnosti je da su stupovi činili ogradu.

#### **SJ 372/373**, (sl. 36)

□ W 26; S-VI

▼ 117,21–116,96

*d* – 0,70 m

#### *Jama*

Manja jama kružnog oblika. Od keramike je pronađen ulomak VKJ 2 i dva ulomka VKJ 29 strukture.

#### **SJ 374/375**, (sl. 36)

□ X 26; S-VI

▼ 117,16–117,0

Dimenzije: 1,20 x 0,77 m

#### *Jama*

Plitka jama svijetlo sive zapune s garom i lijepom. Pronađeno je nekoliko ulomaka keramike VKJ 2 strukture i tanjur T2 (T. 4: 5).

#### **SJ 429/430**, (sl. 36)

□ V 26; S-VII

▼ 117,17–117,09

Dimenzije: 1,2 x 0,38 m

#### *Jama*

Zapuna od sive zemlje s keramikom, lijepom i garom. Keramika uglavnom pripada VKJ 2 strukturi, a pronađen je i ulomak VKJ 14 strukture.

#### **SJ 425/426**, (sl. 36, 39, T. 4: 6–14, T. 5–7)

□ V 28/29; W 29; S-VI

▼ 117,05–116,61

Dimenzije: S–J 7,89 m, I–Z 5,66 m, širina 1,40 m

#### *Radni prostor s nadstrešnicom (?)*

Zapuna u obliku slova L SJ 425/426 činila je cjelinu zajedno sa stupovima SJ 505/506, 526/527, 534/535, 536/537, 542/543, 606/607, 608/609, 610/611, 612/613, 614/615. Zapuna SJ 425 crne je boje s jako puno ugljena, lijepa i keramike.

Među lijepom pronađeni su dosta veliki komadi s negativima tankih daski (T. 6; T. 7: 1–5), (vidi poglavlje 3.7).

### Posthole

South-western posthole of the hut. Backfill is ashen gray, with coal and daub, and several fragments of pottery.

A pot with an obliquely protruding rim which was found in the backfill is of VKJ 2 fabric (Pl. 4: 3), and a pot of the L8 type (Pl. 4: 4) is of fabric VKJ 1. Also found are small fragments of pottery of VKJ 1, VKJ 2 and VKJ 29 fabric.

The hut consisted of four pairs of lateral postholes. Due to the overall width of the object it is assumed that the south posthole SU 136/137 and the north one SU 144/145 must have had the corresponding postholes in the middle so that the structure could carry the roof construction. Units SU 114/115, 110/111 and 120/121 are probably the remains of the cut for the foundation of the walls.

South of the huts are the postholes SU 142/143, 370/371, 372/373, 429/430, 431/432, 433/434, 435/436 and a pit SU 374/375. Their function is not entirely clear, one of the possibilities is that these postholes formed a fence.

#### **SU 372/373**, (fig. 36)

□ W 26; A-VI

▼ 117.21–116.96

*d* – 0.70 m

#### *Pit*

Round pit of small dimensions. Findings consist of one fragment of VKJ 2 fabric and two fragments of VKJ 29 fabric.

#### **SU 374/375**, (fig. 36)

□ X 26; A-VI

▼ 117.16–117.0

Dimensions: 1.20 x 0.77 m

#### *Pit*

Shallow pit with light gray backfill with soot and daub. Few fragments of pottery of VKJ 2 fabric were found as well as a plate T2 (Pl. 4: 5).

#### **SU 429/430**, (fig. 36)

□ V 26; A-VII

▼ 117.17–117.09

Dimensions: 1.2 x 0.38 m

#### *Pit*

Backfill of gray earth with pottery, daub and soot. Ceramics are mostly of VKJ 2 fabric, and a fragment of VKJ 14 fabric was also found.

#### **SU 425/426**, (fig. 36, 39, Pl. 4: 6–14, Pl. 5–7)

□ V 28/29; W 29; A-VI

▼ 117.05–116.61

Dimensions: N–S 7.89 m, E–W 5.66 m, width 1.40 m

#### *Working area with a shed (?)*

L-shaped backfill SU 425/426 constituted a unit, together with postholes SU 505/506, 526/527, 534/535, 536/537,



Također, pronađeni su i komadi koji oblikom upućuju na to da pripadaju uglu objekta obližnje kolibe (T. 7: 1). Veća koncentracija lijepa nalazila se u sjevernom kraku kanala gdje je zapuna bila vrlo tamna s puno ugljena. U zapadnom dijelu sjevernog kraka ima dosta ulomaka keramike, koncentriranih na jednom mjestu, dok ih drugdje ima manje. Zapuna se u sjevernom kraku ukopa podvlači pod bočne stranice dok to u kraku ukopa koji se pruža u smjeru sjever-jug nije zabilježeno.

U dijelu kanala koji se pruža u smjeru sjever-jug, zapuna je tamnosive boje i pri dnu se miješa sa zdravicom. Tu je nađeno dosta keramike. Lijepa ima malo i manjih je dimenzija od ulomaka pronađenih u sjevernom kraku.

Većinu keramike čini lokalno proizvedena (VKJ 2) keramika. Prevladavaju lonci tipa L4 (T. 4: 10–13) VKJ 2 strukture, a prisutni su i lonci L1 (T. 4: 6) VKJ 1 strukture, lonci L3 (T. 4: 7–9) i L8 VKJ 2 strukture. Od iste strukture izrađene su: zdjela (T. 5: 3), posuda (T. 5: 1–2), tava (T. 4: 14) i ručke vrčeva (T. 5: 5–6). Bočne stijenke nedefiniranih oblika izrađene su od pročišćene strukture, vjerojatno uvozne proizvodnje (T. 5: 7–9). U ovaj zapuni pronađeni su i ostaci goveda.

Tu je također pronađena i željezna češljagija, tj. strugačica/grebalica za stoku (T. 5: 10a–10b), (vidi poglavlje 4.3, kat. br. 1).

Da je ovaj prostor služio u radne svrhe govori i pronađeni nalaz kamenog kružnog žrvnja (T. 7: 6), (vidi poglavlje 4.6, kat. br. 1).

U SJ 425/426 pronađena su dva tipa novca: PN 26 s Faustinom II i drugi novac PN 29 koji se može pripisati Gordijanu III ili Galijenu (vidi poglavlje 4.4, kat. br. 1–2) i datira objekt u sredinu 3. st. (T. 5: 11–12), unatoč dataciji dobivenoj <sup>14</sup>C analizom (Tablica 1), lako je nađen ovaj novac, objekt je potrebno smjestiti u mlađe razdoblje, u 3. st.

Ova cjelina definirana je kao radni prostor. Na tlocrtu je oblikovana u obliku slova L, a na njenim rubovima, nalaze se stupovi jedan nasuprot drugog (1,81 m udaljenosti) zbog čega je zaključeno kako se iznad ovog kanala nalazila nadstrešnica koju su nosili pronađeni stupovi.

Pronađena količina lijepa vjerojatno je pripadala kolibi koja se nalazi istočno od kanala. Osim toga imamo i duguljaste jame u koje su mogle biti položene vodoravne grede za temeljenje. Sve upućuje na to da je koliba bila izgrađena od greda, daskaka i obilnog nanosa blata koji se u nekom požaru pretvorio u lijep te je rušenjem i stradanjem tog objekta završio u kanalu SJ 425/426.

Negativi su većim dijelom od pravokutnih daski što nam govori o načinu gradnje objekta i upotrebi obrađenih pravokutnih daski uz šiblje i granje prikupljeno u prirodi. S obzirom na očuvane negative u lijepu (negativ daski) naslućujemo da je taj objekt (koliba) bio građen kombinacijom drvenih stupova, povezanih isprepletenim šibljem i granjem, koje je bilo obloženo blatom i dodatno učvršćeno obrađenim daskama. Krov je vjerojatno bio prekriven slamom budući da tegule nisu pronađene.

542/543, 606/607, 608/609, 610/611, 612 / 613, 614/615. Backfill SU 425 is black with a lot of coal, daub and pottery.

Considerably large pieces with negative imprints of thin planks were found among the daub (Pl. 6, Pl. 7: 1–5) (see chapter 3.7). Also found were pieces indicating by their shape that they were part of a corner of the nearby hut (Pl. 7: 1). A higher concentration of daub was found within the northern part of the channel where the backfill was very dark with a lot of coal. In the western part of the northern branch there were plenty of pottery fragments, concentrated in one place; elsewhere the concentration was not that high. Backfill in the eastern part of the cut goes under the side walls, unlike in the branch of the cut which extends in the north-south direction.

In the part of the channel extending in the north-south direction, backfill is dark gray and at the bottom it is combined with sterile soil. A lot of pottery is found at that particular spot. There is some daub but in chunks smaller than the fragments found in the northern part.

Most of the pottery was locally produced (VKJ 2) ceramics. The predominant type are pots L4 (Pl. 4: 10–13) of VKJ 2 fabric, but there are also pots L1 (T. 4: 6) of VKJ 1 fabric and pots L3 (Pl. 4: 7–9) and L8 of VKJ 2 fabric. Of the same fabric are the following items: bowl (Pl. 5: 3), vessels (Pl. 5: 1–2), pan (Pl. 4: 14) and handles of bowls (Pl. 5: 5–6). The side walls of undefined shapes are made of the refined fabric, probably of imported production (Pl. 5: 7–9). In this backfill the remains of a cow were also discovered.

An iron curry-comb was also found on this location, i.e. a scraper/comb for livestock (Pl. 5: 10a–10b), (see chapter 4.3, Cat. No. 1).

The discovery of a circular whetstone confirms that this space was used for work (Pl. 7: 6) (see chapter 4.6, Cat. No. 1).

In SU 425/426 two types of money were found: SF 26 with *Faustina* II and SF 29, which may be attributed to *Gordianus* III or *Gallienus* (see chapter 4.4, Cat. Nos. 1–2) and which dates the structure to the mid-3<sup>rd</sup> century (Pl. 5: 11–12) despite datation obtained from <sup>14</sup>C analysis (Table 1). Although this money is found in it, the structure should be dated to the later period, i.e. to the 3<sup>rd</sup> century.

This unit is defined as a workspace. It has a L-shaped layout, and at its edges there are postholes facing each other (on a 1.81 m distance) for which it was concluded that over this channel there was a shed, carried by postholes found on the location.

The amount of daub found was probably a part of the hut located east of the channel. In addition, we also have elongated pits in which horizontal beam could have been laid as the foundations. Everything points to the fact that the hut was built of beams, planks and abundant layers of mud which turned into daub as a result of fire and ending up in the channel SU 425/426.



SJ/SU	Radiocarbon Age	Calibrated Age	One Sigma Range	Two Sigma Range
425/426	1863 ± 24	cal AD 130	cal AD 90 - 99 (7.6 %) 126 - 178 (42.1 %) 190 - 213 (18.6 %)	cal AD 82 - 226 (95.4 %)
510/405	BP 1746 ± 24	cal AD 259, 282, 289, 299, 321	cal AD 245 - 263 (16.2 %) 276 - 308 (31.8 %) 315 - 338 (20.3 %)	cal AD 239 - 361 (90.6 %) 368 - 381 (4.8 %)
802/803	1808 ± 29	cal AD 236	cal AD 134 - 161 (17.8 %) 169 - 198 (20.5 %) 208 - 244 (30.1 %)	cal AD 130 - 258 (84.9 %) 282 - 290 (1.9 %) 298 - 321 (8.6 %)
1363/1364	BP 1604 ± 23	cal AD 429	cal AD 419 - 441 (24.6 %) 449 - 467 (14.3 %) 483 - 492 (y 6.8 %) 498 - 512 (10.9 %) 516 - 529 (11.6 %)	cal AD 412 - 534 (95.4 %)
1852/1853	BP 1760 ± 40	cal AD 250	cal AD 230-330 (68 %)	cal AD 140-390 (95 %)

Tablica 1 Prikaz <sup>14</sup>C datuma antičkih cjelina  
Table 1 A display of <sup>14</sup>C dates of antique units

### SJ 427/428+511, (sl. 5, 36, 40, T. 8)

□ U 27/28; S-VI

▼ 117,12-116,95

Dimenzije: 2,72 x 1,43 m

Ognjište?

Zapuna SJ 427 sastojala se od crne zemlje s puno ugljena, lijepa, keramike i nabijene strukture od usitnjenog lijepa SJ 511. Zapuna je nepravilnog oblika, orijentirana u smjeru sjever-jug.

Pronađeni su lonci L4 (T. 8: 6), VKJ 2 strukture, L5 (VKJ 2) (T. 8: 1-3), L8 (VKJ 1, 24) (T. 8: 4-5), T2 tanjur (VKJ 2) (T. 8:

The negatives are mostly of rectangular planks, which tells us about the way of the construction and use of refined rectangular boards together with shrubs and twigs collected in nature. Given the negatives preserved in daub (negative planks) we can assume that the structure (hut) was built by a combination of wooden postholes connected by intertwined branches and brushwood, covered with mud and additionally secured by refined planks. The roof was probably covered with straw since *tegulae* were not found.

### SU 427/428+511, (fig. 5, 36, 40, Pl. 8)

□ U 27/28; A-VI

▼ 117.12-116.95

Dimensions: 2.72 x 1.43 m

Hearth?

Backfill SU 427 consisted of black earth with a lot of coal, daub, ceramics and compact fragmented daub SU 511. Backfill is irregularly shaped, oriented north-south.

Among the findings there are pots L4 (Pl. 8: 6) of VKJ 2



Sl. 39 Presjek kanala SJ 425/426  
Fig. 39 Cross-section of channel SU 425/426



Sl. 40 SJ 511, ostatak ognjišta  
Fig. 40 SU 511, remains of a hearth



7), poklopac P1 (VKJ 2), (T. 8: 9), dna različitih posuda (VKJ 2, 24), (T. 8: 10–11), pompejanski tanjuri koji nisu lokalne proizvodne (VKJ 13), (T. 8: 12–13), ali odgovaraju lokalnom tipu T2. Pored ulomaka prikazanih na T8, pronađeni su i drugi ulomci izrađeni od struktura 2, 13 i 24 koji možda pripadaju gore spomenutim posudama. Također je pronađena neukrašena narukvica od crnog stakla PN 34, tip A2 koja se datira od 3.–7. st. (T. 8: 14) (vidi poglavlje 4.2). Nalazi lonaca (T. 8: 4–5) srodni su posudama iz jame SJ 437/438. U zapuni SJ 427 pronađeni su i ostaci goveda i boba (vidi poglavlje 5.1. tablica 5, i poglavlje 5.2. tablica 8 / III dio).

SJ 511 (sl. 40) je struktura od nabijenog lijepa unutar ukopa SJ 428. Nalazi se na istočnoj strani i na južnom dijelu ukopa SJ 428. S obzirom na veću količinu ugljena i strukturu, moguće da je riječ o ostacima ognjišta. Struktura se nalazi samo u južnom dijelu ukopa. Nalazi datiraju ovu cjelinu u kasnu antiku.

Dimenzije kolibe u ovom kompleksu su 8,2 x 6,3 m. Tragovi središnjih stupova nisu pronađeni, ali morali su postojati kako bi građevina ovih dimenzija mogla nositi krovnu konstrukciju. Južno od kolibe pretpostavljamo da se nalazila ograda, zapadno radni prostor s nadstrešnicom u obliku slova L, a u njegovom produžetku plitka jama s blago zapečenom zemljom i puno nabijenog lijepa koncentriranog na dijelu koji je vjerojatno ostatak ognjišta. Ovaj kompleks tj. njegovi stupovi i jame SJ 120/121, 140/141, 110/111, 138/139 presječeni su kanalom SJ 108/109 i stariji su od 3. kompleksa.

### Kompleks 3 (sl. 5, 36, T. 9)

Treći kompleks se sastoji od kolibe, ograde i jame. Koliibu su činili poluukopani objekt i stupovi: SJ 074/075, 076/77, 078/079, 080/081, 082/083, 084/085, 086/087, 088/089, 090/091, 092/093, 094/095, 098/099, 102/103, 146/147. Kompleks još sačinjavaju jame SJ 100/101, 146/147 (sl. 41), stupovi, 148/149, 150/151 te ograda 108/109, 116/117 koja sječe ukope kompleksa B.

#### **SJ 074/075, 078/079, 080/081, 082/083, 084/085, 086/087, 088/089, 090/091, 092/093, 094/095, 098/099, 102/103**

□ W/X/Y/Z 26/27/28/29/30; S–VI

Dimenzije: dužina 12,12, s nadstrešnicom 14,6, širina u rekonstrukciji 10,6 m

#### *Koliba*

Za ovu kolibu se pretpostavlja da je mogla imati nadstrešnicu na sjevernom dijelu. Koliba je vjerojatno bila djelomično ukopana s obzirom na središnji dio s plićim ukopima SJ 076/077, SJ 104/105 i 106/107. Ti su ukopi mogli činiti mjesto na kojemu je bila položena središnja greda. Na njoj su se nalazili nosivi stupovi za dodatno rasterećivanje svoda budući da je riječ o većoj kući.

fabric, L5 (VKJ 2) (Pl. 8: 1–3), L8 (VKJ 1, 24) (Pl. 8: 4–5), plate T2 (VKJ 2) (Pl. 8: 7), lid P1 (VKJ 2), (Pl. 8: 9), bases of different vessels (VKJ 2, 24), (Pl. 8: 10–11) and Pompeian plates which are not locally produced (VKJ 13), (Pl. 8: 12–13), but do match local type T2. In addition to the fragments shown on Pl. 8, fragments made of fabrics 2, 13 and 24 were found, which might belong to the above-mentioned vessels. An undecorated black glass bracelet SF 34, type A 2, which dates from the 3<sup>rd</sup> to the 7<sup>th</sup> century, was found as well (Pl. 8: 14) (see chapter 4.2). Findings of pots (Pl. 8: 4–5) are similar to vessels from the pit SU 437/438. In the backfill SU 427 the remains of a cow and broad beans were found (see chapter 5.1. table 5 and chapter 5.2. table 8 / part III).

SJ 511 (fig. 40) is a structure of compact daub within cut SU 428. It is located on the eastern side and on the southern part of cut SU 428. With regard to a larger amount of coal and the structure, it is possible that these are the remains of a hearth. The structure is located only in the southern part of the cut. Findings date this unit to the late Antiquity.

Dimensions of the hut in this complex are 8.2 x 6.3 m. Traces of the central postholes were not found, but they had to be present so a building of this size could carry the roof construction. We assume that there was a fence south of the hut, a workspace with a L-shaped shed on the west, and in its extension a shallow pit with slightly burnt earth and a lot of compact daub concentrated in the area that is likely to be residual of the hearth. This complex, i.e. its postholes and pits SU 120/121, 140/141, 110/111, 138/139 have been intersected by channel SU 108/109 and are older than complex 3.

### Complex 3 (fig. 5, 36, Pl. 9)

Complex 3 consists of a hut, a fence and a pit. The hut is composed of a pit house and postholes: SU 074/075, 076/77, 078/079, 080/081, 082/083, 084/085, 086/087, 088/089, 090/091, 092/093, 094/095, 098/099, 102/103, 146/147. Other parts of the complex are pits SU 100/101, 146/147 (fig. 41), postholes SU 148/149, 150/151 and a fence SU 108/109, 116/117 which intersects the cuts of the complex B.

#### **SU 074/075, 078/079, 080/081, 082/083, 084/085, 086/087, 088/089, 090/091, 092/093, 094/095, 098/099, 102/103**

□ W/X/Y/Z 26/27/28/29/30; A–VI

Dimensions: length 12.12, with a shed 14.6, width of the reconstruction 10.6 m

#### *Hut*

The northern edge of this pithouse consisted presumably of a shed. The hut was probably partially buried if we consider the central part with its shallow cuts SU 076/077, SU 104/105 and SU 106/107. These cuts could have formed the place where the central beam was laid. It held the sup-

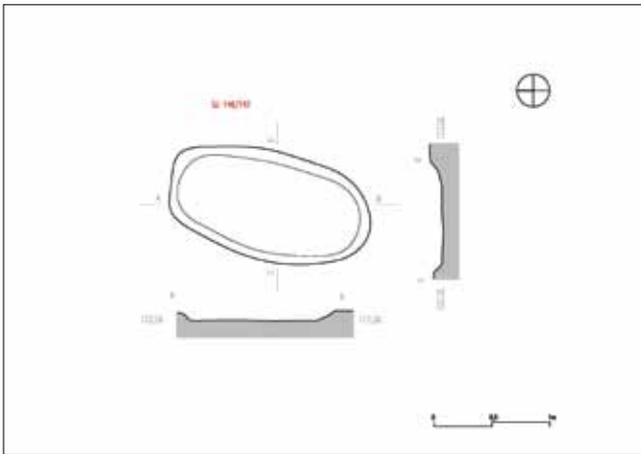

Sl. 41 Tlocrt ukopa SJ 146/147  
Fig. 41 Layout of the cut SU 146/147



Sl. 42 Nalaz *in situ* noža i keramičke posude  
Fig. 42 Finding of the knife *in situ* and a ceramic vessel

**SJ 076/077**, (sl. 36, 42–43)

□ Y 28; S–VI

▼ 117,24–117,12

Dimenzije: 2,33 x 4,50 m

*Koliba – poluukopani dio*

Zapuna se sastoji od crne zemlje s puno ugljena i sušene opeke te velikih komada lijepa.

U sredini zapune pronađen je željezni nož (T. 9: 6), (vidi poglavlje 4.3, kat. br. 3, sl. 42) uz zdjelu Z1 (T. 9: 4), ulomci posuda lokalne izrade, lonac tipa L2 (T. 9: 1) te ulomak koji bi mogao biti L5 (T. 9: 2). Izrađeni su od VKJ 2 strukture. Pronađeno je dno veće posude grube izrade (T. 9: 5) koja je mogla služiti za čuvanje namirnica, izrađena od strukture VKJ 22 (koja se još nalazi samo u objektu SJ 1363/1364 iz 5. st.). Od biljnih ostataka tu su pronađeni ostaci koro-va, krušne pšenice (vidi poglavlje 5.2 tablica 8/II dio) i životinjskih kostiju (vidi poglavlje 5.1, tablica 5).

**SJ 104/105**, (sl. 36, 44, T. 7–10)

□ X 27; S–VI

▼ 117,25–116,87

Dimenzije: 1 x 4,78 m

*Ukop za polaganje temelja kolibe*

Jama izduljenog oblika. U središnjem dijelu nalazi se stup. Zapuna je sivo pepeljasta na južnom dijelu, a na sjevernom je tamnija. Vjerojatno je tu bila položena vodoravna greda za temeljenje središnjeg zida kolibe i jedan nosivi stup.

U jami je pronađena keramika: lonac L3 (T. 9: 7), dno posude i ulomci lijepa s negativima drvene konstrukcije kolibe (T. 9: 8–9) s jedne strane, dok su s druge strane zaglađeni. Pronađen je željezni predmet, vjerojatno dio ručke kovčežića (T. 9: 10) (vidi poglavlje 4.3, kat. br. 4). Pronađeni su i životinjski ostaci (vidi poglavlje 5.1).

**SJ 106/107**, (sl. 36, 45)

□ X 27/26; S–VI

porting postholes for further relieving of the vault since this was a large house.

**SU 076/077**, (fig. 36, 42–43)

□ Y 28; A–VI

▼ 117,24–117,12

Dimensions: 2.33 x 4.50 m

*Hut – a half-buried segment*

Backfill consists of black earth with lots of coal and adobe bricks, and large pieces of daub.

In the middle of the backfill an iron knife was found (Pl. 9: 6), (see chapter 4.3, Cat No. 3, fig. 42) with a bowl Z1 (Pl. 9: 4), fragments of a locally made vessel, pot of the L2 type (Pl. 9: 1) and a fragment which could be L5 (Pl. 9: 2). All are made of VKJ 2 fabric. The base of a larger coarse vessel was also found (Pl. 9: 5) which could have been used for food storage, and was made of VKJ 22 fabric (apart from this structure, found only in structure SU 1363/1364 from the 5<sup>th</sup> century). The plant remains that have been found are those of weeds and bread wheat (see chapter 5.2, Table 8 / part II) together with animal bones (see chapter 5.1, Table 5).

**SU 104/105**, (fig. 36, 44, Pl. 7–10)

□ X 27; A–VI

▼ 117,25–116,87

Dimensions: 1 x 4.78 m

*Cut for the foundations of the hut*

Elongated pit with a posthole in its central part. Backfill is ashen gray on the south, and darker on the north. Probably there was a horizontal beam laid here as a foundation of the central wall of the hut and one bearing posthole.

The following ceramics were found in the pit: pot L3 (Pl. 9: 7), the base of a vessel and fragments of daub with imprint of the wooden structure of the hut (Pl. 9: 8–9) on one side, while the other side is smoothed. An iron item was found, probably a part of a casket handle (Pl. 9: 10) (see

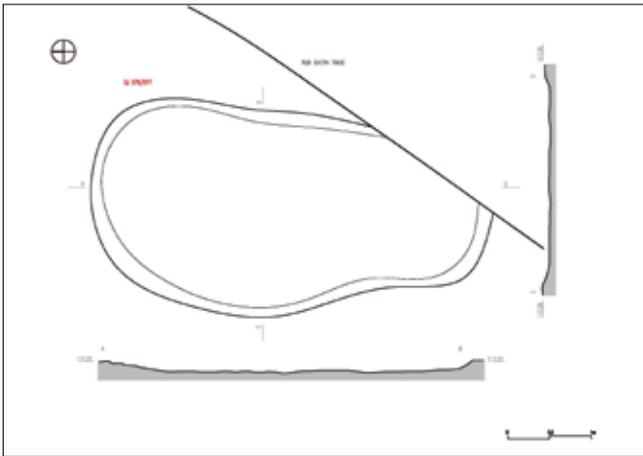

Sl. 43 Tlocrt ukopa SJ 076/077  
Fig. 43 Layout of the cut SU 076/077

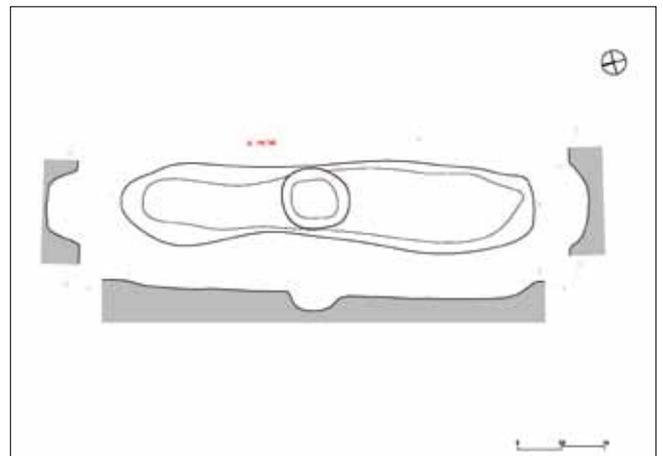

Sl. 44 Tlocrt ukopa SJ 104/105 sa stupom otkrivenim na dnu ukopa  
Fig. 44 Layout of the cut SU 104/105 with the posthole discovered at the bottom of the cut

▼ 117,22–116,99

Dimenzije: 3,22 x 0,72 m

Ukop za polaganje temelja

Ukop izduljenog oblika u produžetku SJ 104/105 s vjerojatno istom funkcijom. Zapuna je sive, pepeljaste boje s većim komadima lijepa i ugljena.

Pronađen je ulomak L4 lonca VKJ 2 strukture i ulomak dna koji mu vjerojatno pripada (T. 9: 11 a–b), ulomci različitog posuđa iste strukture te ulomci crveno slikane keramike (T. 9: 12 a–b).

**SJ 116/117**, (sl. 36)

□ W/X 28/29; S–VI

▼ 117,20–116,95 m

Ograda

Zapuna je sive boje, u njoj je pronađeno malo lokalno proizvedene keramike (VKJ 2).

Nalazi pronađeni u ovom kompleksu ukazuju na dataciju od 2 do 4. st. Odnos ograde trećeg kompleksa prema

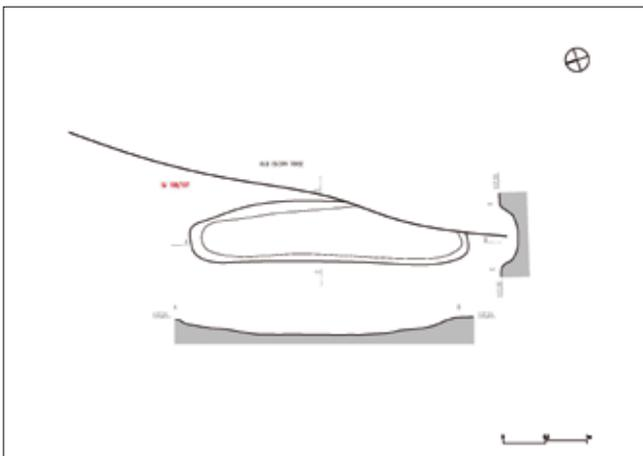

Sl. 45 Tlocrt ukopa SJ 104/105  
Fig. 45 Layout of the cut SU 104/105

chapter 4.3, Cat. No. 4). The structure contained animal bones (see chapter 5.1).

**SU 106/107**, (fig. 36, 45)

□ X 27/26; A–VI

▼ 117,22–116,99

Dimensions: 3.22 x 0.72 m

Cut for the foundations

Elongated cut in the extension of SU 104/105 and probably of the same function. Backfill is ashen gray, with large pieces of daub and coal.

A fragment of L4 pot of VKJ 2 fabric was found and a fragment of a base probably belonging to the pot (Pl. 9: 11 a–b) as well as fragments of various dishes of the same fabric and fragments of red painted pottery (Pl. 9: 12 a–b).

**SU 116/117**, (fig. 36)

□ W/X 28/29, A VI

▼ 117,20–116,95 m

Fence

Gray backfill with some locally made ceramics (VKJ 2).

The findings found in this complex indicate to a dating from the 2<sup>nd</sup> to the 4<sup>th</sup> century. The fence of complex 3 and the hut in complex 2 narrows this dating since this fence intersected a part of a cut in complex 2. Complex 2 is dated to the middle of the 3<sup>rd</sup> century by <sup>14</sup>C dating of coal and findings, and was probably in use for some time; thus, according to that, complex 3 dates to the second half or the end of the 3<sup>rd</sup> and the beginning of the 4<sup>th</sup> century at the earliest. Part of the complex extends beyond the excavated surface so that it is not fully examined. The findings indicate the residential character of this unit rather than pointing towards an area of economic or technological nature.





kolibi iz kompleksa 2 sužava tu dataciju budući da je ta ograda presjekla dio ukopa iz kompleksa 2. Kompleks 2 datiran je u sredinu 3. st. prema <sup>14</sup>C dataciji ugljena i nalazima, a vjerojatno je bio u upotrebi neko vrijeme, prema čemu se kompleks 3 datira najranije u drugu polovinu ili kraj 3. te u početak 4. st. Dio kompleksa izlazi iz trase te nije u cijelosti istražen. Nalazi upućuju na stambeni karakter ove cjeline više nego na prostor gospodarske ili tehnološke prirode.

#### Kompleks 4

Kompleks se sastoji od poluukopanog objekta, jama i stupova koji su možda dio ograde.

#### SJ 404/405+501+499/509/510/500+497/498,

(sl. 5, 46–49, T. 10–13)

□ K/L 29/30; S–VII

▼ 117,52–116,51

Dimenzije: 5,74 x 3,6 m

*Stambeni objekt*

Zapuna SJ 404 je sive do crne boje. Ispod zapune SJ 404 nalaze se dva ukopa koji su sastavni dio većeg ukopa SJ 405: SJ 497/498 na sjeverozapadnom i 499/500+509+510 na jugoistočnom dijelu. U središnjem dijelu, između ukopa, a ispod SJ 404, nalazila se zapuna SJ 501, sive boje.

Zapuna SJ 497 tamnosive je do crne boje s ugljenom i keramikom. U tom se dijelu nalazi i veća količina lijepa, a pronađen je i ulomak sitnije životinje, ovce ili koze (Vidi poglavlje 5.1, tablica 5). Zapuna SJ 499 crne je boje sa jako puno ugljena i velikim komadima keramike. Pri dnu zemlja postaje pjeskovitija i miješa se sa zdravicom. Zapuna je rahla i pepeljasta

Zapuna SJ 509 siva je zemlja s malo nalaza, a ispod nje je pronađena zapuna SJ 510 s puno ugljena.

SJ 404/405: u objektu je pronađena velika količina raznolikih nalaza: keramika lokalne proizvodnje (T. 10–11), uvozna keramika (T. 12: 1–7), noževi (vidi poglavlje 4.3. kat. br. 5–13), (T. 12: 11, 12, 17), željezna igla (T. 12: 16), šilo (T. 12: 18), strugač (T. 12: 13), ulomak brončane posude (T. 12: 19) i ulomci stakla (vidi poglavlje 4.1, kat. br. 2–3), (T. 12: 9–10). U SJ 510 otkriveni su i veliki komadi lijepa (T. 13), (vidi poglavlje 3.7).

Životinjske kosti i tragovi biljnih ostataka pronađeni su u zapuni SJ 404 (ostaci žitarica i krušne pšenice), SJ 497 (životinjske kosti krupne stoke, ekvida i svinje, od biljnih ostataka pronađeni su raži i pravi pir) te u zapuni SJ 510 (životinjske kosti, borovnica, proso i druge kultivirane biljke) (vidi poglavlja 5.1–5.2, tablice 5 i 8/III).

Pronađeni su i amorfnji željezni fragmenti (T. 12: 14–15) koji, uz trosku koja se nalazila u ovom objektu, govore o metalurškoj aktivnosti na ovom dijelu lokaliteta (vidi poglavlje 4.5).

Od brojnih keramičkih ulomaka izdvajaju se lonci L2 (T. 10: 1–7), L3 (T. 10: 8–11), L4 (T. 10: 12), L5 (T. 10: 13–16), nedefinirani tip lonca (T. 11: 1), tanjuri T1 i T2 (T. 11: 2–3), poklopci

#### Complex 4

Complex consists of a pit house, pits and postholes which could be a part of a fence.

#### SU 404/405+501+499/509/510/500+497/498,

(fig. 5, 46–49, Pl. 10–13)

□ K/L 29/30; A–VII

▼ 117.52–116.51

Dimensions: 5.74 x 3.6 m

*Residential facility*

Backfill SU 404 is gray to black. Underneath there are SU 404 backfill, there are two cuts which are an integral part of a larger cut SU 405: SU 497/498 on the northwest and SU 499/500+509+510 in the southeast part. In the central part, between the cuts, and under SU 404, there was gray backfill SU 501.

Backfill SU 497 is dark gray to black with coal and pottery. In this part, there is a larger amount of daub; a fragment of a small animal, a sheep or a goat, was found as well (see chapter 5.1, Table 5). Backfill SU 499 is black with a lot of coal and large fragments of pottery. At the bottom the earth becomes more sandy and it blends with sterile soil. Backfill is loose and ashen.

Backfill SU 509 is gray with scarce findings, and beneath it backfill SU 510 with a lot of coal was discovered.

SU 404/405: SU 404/405 contained an unusually large number of finds locally produced ceramics (Pl. 10–11), imported ceramics (Pl. 12: 1–7), knives (see chapter 4.3. Cat Nos. 5–13), (Pl. 12: 11, 12, 17), an iron needle (Pl. 12: 16), an awl (Pl. 12: 18), a scraper (Pl. 12: 13), a fragment of a bronze vessel (Pl. 12: 19) and fragments of glass (see chapter 4.1, Cat. Nos. 2–3), (Pl. 12: 9–10). In SU 510 large pieces of daub were discovered (Pl. 13) (see chapter 3.7).

Animal bones and traces of plant remains were found in the backfill SU 404 (remains of cereals and bread wheat), SU 497 (cattle, *equidae* and pig bones, rye and spelt residue) and in backfill SU 510 (animal bones, blueberry, millet and other cultivated plants) (see chapter 5.1–5.2, table 5:08 / III).

Amorphous iron fragments were also found (Pl. 12: 14–15) which, along with the slag which was in the same object, indicate metallurgical activities on this part of the site (see chapter 4.5).

Of the numerous pottery fragments we can single out pots L2 (Pl. 10: 1–7), L3 (Pl. 10: 8–11), L4 (Pl. 10: 12), L5 (Pl. 10: 13–16), undefined type of a pot (Pl. 11: 1), plates T1 and T2 (Pl. 11: 2–3), lids P1–3 (Pl. 11: 4–6), glazed bowl Z3 (Pl. 11: 7), undefined shape of vessel (Pl. 11: 8). Glazed mortars Tr3 and other fragments of undefined shape (Pl. 12: 2–4), a fragment of a large jug or table amphora (Pl. 12: 5), and tableware made of gray fired clay (Pl. 12: 6–7) are not locally produced.

Among the ceramic material, late antique glazed bowl and glazed mortars provide good dating evidence and



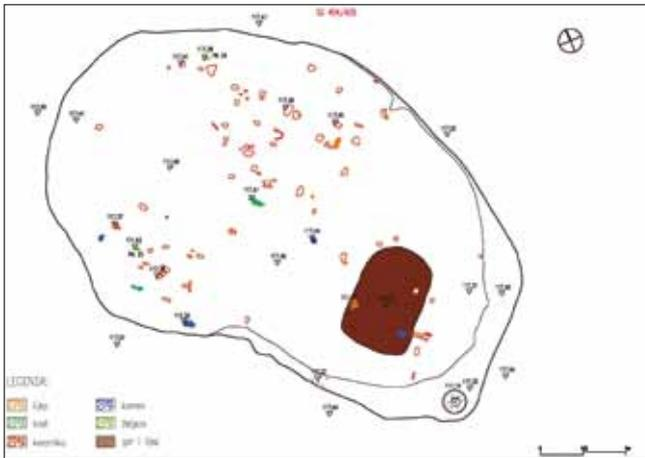

Sl. 47 Tlocrt zapune SJ 405  
Fig. 47 Layout of the backfill SU 405

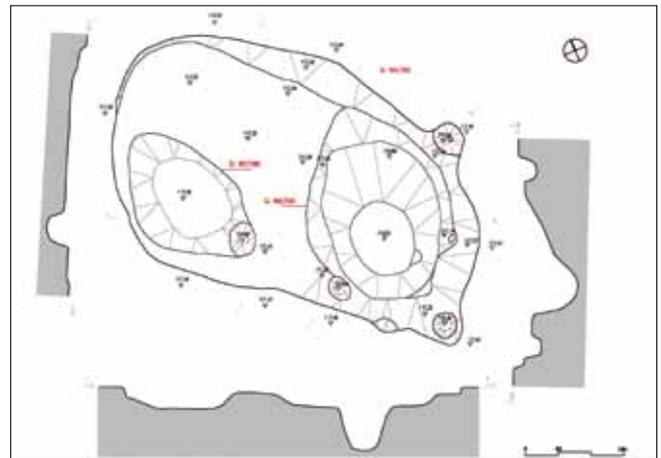

Sl. 48 Tlocrt ukopa SJ 405 nakon pražnjenja zapuna  
Fig. 48 Layout of the cut SU 405 after the removal of the backfill



Sl. 49 Objekt nakon pražnjenja, pogled istok-zapad  
Fig. 49 The structure after the removal of the backfill, east-west view

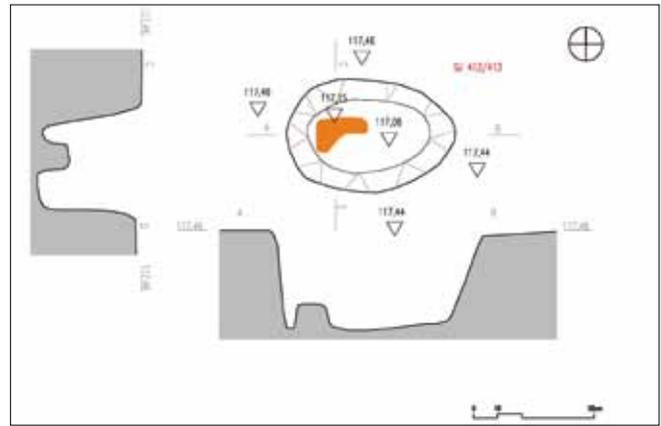

Sl. 50 Tlocrt SJ 412/413 s lijepom  
Fig. 50 Layout of SU 412/413 with daub

P1-3 (T. 11: 4-6), glazirana zdjela Z3 (T. 11: 7), nedefinirani oblik posude (T. 11: 8). Lokalnoj proizvodnji ne pripadaju glazirani tarionici Tr3 i drugi ulomci nedefiniranih oblika (T. 12: 2-4), ulomak velikog vrča ili stolne amfore (T. 12: 5) te stolnog posuđa od sivo pečene gline (T. 12: 6-7).

Od keramičkog materijala, za dataciju su osjetljivi kasnoantička glazirana zdjela te glazirani tarionici koji ranije dobivenu dataciju  $^{14}\text{C}$  analize potvrđuju (tablica 1). U takav vremenski okvir uklapaju se i ulomci staklene čaše (vidi poglavlje 4.1) te ulomak brončane zdjele (vidi poglavlje 4.3). U objektu (ukop SJ 405), pronađeno je najviše životinjskih ostataka na lokalitetu (poglavlje 5.1). Objekt SJ 404/405 datiran je u 3/4. st.  $^{14}\text{C}$  analizom, a dodatna analiza arheoloških nalaza to dodatno sužava. Iz najdoljnje zapune SJ 510 analiziran je uzorak ugljena  $^{14}\text{C}$ , a dobivena datacija smješta ga, s najvećim postotkom sigurnosti, u drugu polovinu 3. i prvu polovinu 4. st. (tablica 1).

Lako se može pretpostaviti kako su ukopi SJ 500 i 498, unutar SJ 405 bili natkriveni daskom čime se iznivelira-

have been used to confirm dates previously obtained by  $^{14}\text{C}$  analysis (Table 1). Fragments of a glass cup (see chapter 4.1) and a fragment of a bronze bowl (see chapter 4.3) fit in the same time-frame. The largest part of animal remains was found in this structure (cut SU 405) (see chapter 5.1). Structure SU 404/405 is dated to the 3<sup>rd</sup>/4<sup>th</sup> century using the  $^{14}\text{C}$  analysis, and the additional analysis of archaeological finds further narrows the margins. From the lowermost backfill SU 510 a sample of coal was analyzed by  $^{14}\text{C}$ , and the results date it, with the highest percentage of security, to the second half of the 3<sup>rd</sup> and the first half of the 4<sup>th</sup> century (Table 1).

It can easily be assumed that cuts SU 500 and 498, within SU 405 were covered with a plank in order to level the walking surface of the facility, while the space under the lid served as a space for storing groceries. In cuts within SU 405 a significant quantity of coal was discovered (perhaps the remains of planks) and various finds, food re-



la hodna površina objekta, a prostor ispod tog pokrova je služio kao prostor za skladištenje namirnica. U ukopima unutar SJ 405 pronađena je znatna količina ugljena (možda ostatci dasaka) i raznovrsnih nalaza, ostaci hrane, oruđa i pribora.

Oko ukopa SJ 405 pronađeno je više stupova koji su vjerojatno povezani s njim: SJ 246/247, 304/305, 406/407, 408/409, 412/413, 414/415, 418/419, 420/421, 422/423, 483/484, 485/486. Prema rasporedu stupova koji su očuvani, čini se kako je ovaj objekt bio natkriven. Ulaz se vjerojatno nalazio s bočne, jugozapadne strane na što ukazuju stupovi. Stranice objekta su bile zazidane šibljem i blatom s obzirom da je unutar objekta pronađena veća količina lijepa.

Oblik objekta, nalazi, raspored stupova govore u prilog činjenici kako je ovdje riječ o stambenom objektu koji je imao poluukopani dio za spremanje namirnica.

#### **SJ 238/239**, (sl. 46)

□ L/M 29; S–VII

▼ 117,517–117,25

Dimenzije: 1,15 x 0,8 m

*Jama*

Jama sa zapunom od crnosive zemlje s dosta gara i lije-pa. Nalazi se istočno od ukopa SJ 405.

Pored narukvice (T. 12: 8), (vidi poglavlje 4.2. kat. br. 4), pronađena je keramika, najvećim dijelom lokalne proizvodnje (VKJ 2), a manje uvozna keramika (VKJ 14 i 4).

#### **SJ 412/413**, (sl. 46, 50–51)

□ L 29; S–VII

▼ 117,50–117,03

Dimenzije: 0,59 x 0,45 m

*Stup/Jama*

Pronađeni su ulomci lijepa, lokalno proizvedene keramike (VKJ 2, 24) u većem stupu ili manjoj jami, istočno od SJ 404/405, a zapadno od SJ 238/239.

### **Kompleks 5**

Peti kompleks čine stupovi (ostaci kuće) i nekoliko jama koje su ostaci radnih prostorija i objekata nejasne namjene (sl. 52–53). Početna visina je u prosjeku na 117,5 cm, a ukopi stupova su duboki oko 20 cm, promjera otprilike isto toliko.

#### **SJ 192/193, 202/203, 210/211, 212/213, 228/229, 230/231, 232/233, 234/235, 236/237, 240/241, 242/243 244/245**, (sl. 46)

□ M/N/O 28/29/30/31; S–VII

Dimenzije: 6 x 7,5, s nadstrešnicom 6 x 8,7 m

*Koliba*

Stupovi koji su činili kuću su SJ 192/193, 202/203, 210/211, 212/213, 228/229, 230/231, 232/233, 234/235, 236/237, 240/241, 242/243, 244/245. Kuća je zbog velikih dimenzija morala

mains, tools and utensils.

Around cut SU 405, several postholes, probably associated with it, were found: SU 246/247, 304/305, 406/407, 408/409, 412/413, 414/415, 418/419, 420/421, 422/423, 483/484, 485/486. According to the layout of preserved postholes, it would appear that this object had a roof. The entrance was probably located on the lateral, southwest side which is indicated by postholes. Walls of the object were paved with wattle and mud since a large amount of daub was found inside it.

The shape of the object, findings, the arrangement of postholes, they all speak in favour of the fact that this is a residential building which had a half-buried part used for food storage.

#### **SU 238/239**, (fig. 46)

□ L/M 29; A–VII

▼ 117.517–117.25

Dimensions: 1.15 x 0.8 m

*Pit*

Pit with greyish black earth backfill with plenty of coal and daub. It is located east of the cut SU 405.

In addition to a bracelet (Pl. 12: 8) (see chapter 4.2. Cat. No. 4), mostly locally produced pottery was found (VKJ 2), and only a few pieces of imported ceramics (VKJ 14 and 4).

#### **SU 412/413**, (fig. 46, 50–51)

□ L 29; A–VII

▼ 117.50–117.03

Dimensions: 0.59 x 0.45 m

*Posthole/Pit*

In a larger posthole or in a smaller pit east of SU 404/405 and west of SU 238/239, fragments of daub and locally produced ceramics were found.

### **Complex 5**

Complex 5 consists of postholes (remnants of the house) and a few pits that are remnants of work premises and facilities of undetermined purpose (fig. 52–53). The initial average height was 117.5 cm, and posthole cuts are approximately 20 cm deep, the same diameter.

#### **SU 192/193, 202/203, 210/211, 212/213, 228/229, 230/231, 232/233, 234/235, 236/237, 240/241, 242/243 244/245**, (fig. 46)

□ M/N/O 28/29/30/31; A–VII

Dimensions: 6 x 7.5, with a shed 6 x 8.7 m

*Hut*

Postholes which form a house are as follows: SU 192/193, 202/203, 210/211, 212/213, 228/229, 230/231, 232/233, 234/235, 236/237, 240/241, 242/243, 244/245. Due to its large size, the house should have had a central row of postholes such as SU 192/193 and 236/237 to carry the roof. On the south side there are three postholes that could have carri-

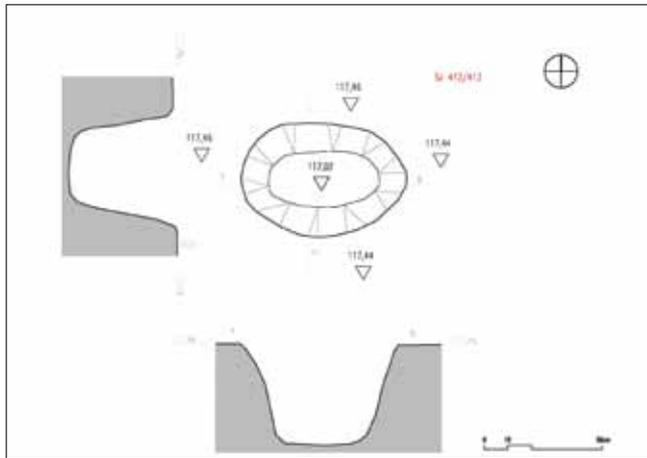

Sl. 51 Tlocrt ukopa SJ 412/413  
Fig. 51 Layout of the cut SU 412/413



Sl. 52 Zapuna SJ 188/189  
Fig. 52 Backfill SU 188/189

imati središnji red stupova kao što su SJ 192/193 i 236/237 radi nosivosti krova. S južne strane nalaze se tri stupa koja su mogla nositi nadstrešnicu pa se pretpostavlja da je ulaz u kolibu bio s južne strane. Sjeverno od kuće, nalazi se nekoliko jama za koje se smatra da su dio radnih prostorija. Očuvane su samo plitke jame, bez stupova pa je teško reći kako su bile natkrivene. Tu je pronađeno dno posude *in situ* i keramički pršljen pa možemo govoriti o tome kako je ova zona služila za skladištenje hrane i izradu vune za potrebe domaćinstva. Većina nalaza pronađena je u cjelinama sjeverno od kuće, što je i logično budući da su od kuće preostali samo plitki stupovi.

#### SJ 244/245, (sl. 46)

□ N 28; S-VII  
▼ 117,41–117,25  
*d* – 0,24 m

#### Stup

Stup kolibe sa zapunom od sivosmeđe zemlje s mrvicama gara i lijepa. Pronađena je keramika lokalne proizvodnje i ulomak zdjele (T. 14: 1) strukture VKJ 13.

#### SJ 188/189, (sl. 52–54)

□ N/O 31; S-VII  
▼ 117,47–117,32  
Dimenzije: 3,02 x 0,72/1,33 m

#### Ukop nejasne namjene

Siva zapuna s lijepom i garom, nepravilnog izduženog oblika. Zapadni dio zapune je od tamnije, crne zemlje. U središnjem dijelu pronađena su četiri plitka stupa.

#### SJ 194/195, (sl. 46)

□ N 30; S-VII  
▼ 117,48–117,36  
Dimenzije: 1,35 x 0,63 m

#### Radni prostor

Zapuna sive boje s lijepom i garom. Na vrhu zapune

ed the shed so that it is assumed that the entrance to the hut was on that side. North of the house a number of pits form the working space. Only shallow pits without postholes are preserved making it impossible to tell how these premises were roofed. The base of a vessel was found here *in situ* as well as a ceramic whorl, so we can say that this area was used for food storage and production of wool for domestic purposes. Most of the findings were found in the units north of the house, which seems logical since only the shallow postholes are preserved.

#### SU 244/245, (fig. 46)

□ N 28; A-VII  
▼ 117.41–117.25  
*d* – 0.24 m  
*Posthole*

A posthole of the hut with greyish brown earth backfill with crumbles of soot and daub. Locally produced pottery and a fragment of a bowl (Pl. 14: 1) of VKJ 13 fabric were found.

#### SU 188/189, (fig. 52–54)

□ N/O 31; A-VII  
▼ 117.47–117.32  
Dimensions: 3.02 x 0.72/1.33 m  
*Cut of an undetermined purpose*

Gray backfill with daub and soot of an irregular elongated shape. Western part of the backfill consists of darker, black earth. In the central part four shallow postholes were found.

#### SU 194/195, (fig. 46)

□ N 30; A-VII  
▼ 117.48–117.36  
Dimensions: 1.35 x 0.63 m  
*Working premises*

Gray backfill with daub and soot. At the top of the

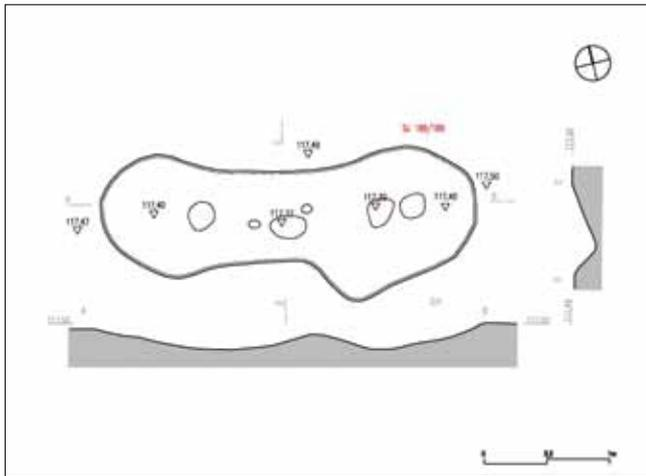

Sl. 53 Tlocrt SJ 188/189  
Fig. 53 Layout of SU 188/189



Sl. 54 Ukop SJ 188/189 sa zapunama stupova na dnu  
Fig. 54 Cut SU 188/189 with posthole backfills at the bottom

pronađena je manja koncentracija keramike i lijepa.

Također je pronađen ulomak zdjelice vrlo blage S profilacije kat br. 102 (T. 14: 4) te ulomak poklopca P1 (T. 14: 3). Od nalaza tu su još kamen i ostaci žitarica (vidi poglavlje 5.2, tablica 8/II dio) i nešto spaljenih životinjskih kostiju. Pri vrhu zapune nalazi se i pršljen PN 15 (T. 14: 2).

#### **SJ 196/197**, (sl. 46, 55–56)

□ N 31; S–VII

▼ 117,51–117,41

Dimenzije: 1,17 x 1,06 m

*Jama za pohranu namirnica*

Zapuna od sive zemlje s lijepom i garom. U ovoj maloj jami pronađeni su ulomci dna dvaju lonaca lokalne proizvodnje (T. 14: 5–6), VKJ 2 strukture. Jedan od njih je pronađen *in situ*.

#### **SJ 198/199**, (sl. 57)

□ M/N 31; S–VII

▼ 117,51–116,66

Dimenzije: 1,24 x 0,85 m

*Jama*

Zapuna crvene boje, pomiješana s pješčenjakom i lijepom.

Pronađen je samo jedan ulomak keramike i ostaci žitarica (vidi poglavlje 5.2, tablica 8 / II dio).

Nalazi koji su pronađeni u cjelinama ovog kompleksa datiraju ga u 3. i 4. st. Riječ je o kolibi koja je na južnoj strani imala ulaz s nadstrešnicom, a sa sjeverne strane radne prostore.

#### **Kompleks 6** (sl. 46, 67)

Kompleks se sastoji od kolibe i vjerojatno ograde, a sastoji se od slijedećih cjelina: SJ 154/155; 156/157, 158/159, 160/161, 162/163, 164/165, 170/171, 176/177, 178/179; 166/167, 184/185, 214/215, 220/221, 222/223, 224/225, 226/227; 152/153;

backfill a small concentration of pottery and daub was found.

Also found is a fragment of a bowl with a shallow s-shaped profile Cat. No. 102 (Pl. 14: 4) and a fragment of a lid P1 (Pl. 14: 3). Among the findings there is also stone and remains of cereals (see chapter 5.2, Table 8 / part II) and some burned animal bones. At the top of the backfill there was a whorl SF 15 (Pl. 14: 2).

#### **SU 196/197**, (fig. 46, 55–56)

□ N 31; A–VII

▼ 117.51–117.41

Dimensions: 1.17 x 1.06 m

*Pit for food storage*

Gray earth backfill with daub and soot. In this small pit stood the fragmented bases of two pots made in the local VKJ2 fabric, one of them *in situ*.

#### **SU 198/199**, (fig. 57)

□ M/N 31; A–VII

▼ 117.51–116.66

Dimensions: 1.24 x 0.85 m

*Pit*

Red coloured backfill, mixed with sandstone and daub.

Only one fragment of pottery is found and remains of cereals (see chapter 5.2, Table 8 / part II).

Findings found in units of this complex date it to 3<sup>rd</sup> and the 4<sup>th</sup> century. This is a hut which had an entrance with a shed on its south side, and working premises on the north side.

#### **Complex 6** (fig. 46, 67)

The complex consists of a hut and probably a fence which are composed of the following units: SU 154/155; 156/157, 158/159, 160/161, 162/163, 164/165, 170/171, 176/177, 178/179; 166/167, 184/185, 214/215, 220/221, 222/223, 224/225,

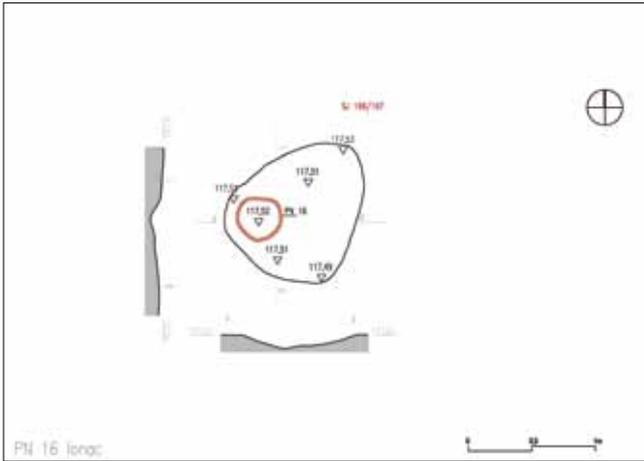

Sl. 55 Tlocrt SJ 196/197 s posudom *in situ*  
Fig. 55 Layout of SU 196/197 with a vessel *in situ*



Sl. 56 SJ 196/197 tijekom istraživanja  
Fig. 56 SU 196/197 during the excavations

168/169; 190/191; 174/175

**SJ 154/155, 156/157, 158/159, 160/161,  
162/163, 164/165, 170/171, 176/177, 178/179**

□ O/R 28/31; S–VII

Dimenzije: 7 x 3,1; s nadstrešnicom: 8,2 x 3,1 m

*Koliba*

Navedeni stupovi čine kolibu koja vjerojatno nije imala središnji red stupova. U zapunama stupova pronađeni su sitni ostaci ugljena, lijepa i keramike koju nije moguće detaljno definirati osim toga da je izrađena od lokalne VKJ 2 strukture.

**SJ 166/167, 184/185, 214/215, 220/221,  
222/223, 224/225, 226/227**

*Ograda*

Zapadno od stupova kolibe nalazi se nekoliko stupova koji mogu pripadati ogradi ili nekom ranijem objektu. Početna visina stupova ograde je na 117,3 cm, a relativne su dubine oko 10 cm i pliće od stupova kopanih za kolibu.

**SJ 226/227, (sl. 46)**

□ P 28; S–VII

▼ 117,30–117,13

*d* – 0,21 m

Dva ulomka lokalno izrađene keramike, VKJ 2 i VKJ 29 strukture (koja se javlja u cjelinama iz 3.–4. st.).

**SJ 152/153, (sl. 46, 58–60)**

□ R 28/29; S–VII

▼ 117,34–117,06

*d* 1,30 m

*Jama*

Zapuna sive boje, kružnog oblika s komadićima lijepa.

U ovoj otpadnoj jami pronađeno je nekoliko amorfnih ulomaka lokalno proizvedene keramike (VKJ 2), ali i jedan

226/227; 152/153; 168/169; 190/191; 174/175

**SU 154/155, 156/157, 158/159, 160/161,  
162/163, 164/165, 170/171, 176/177, 178/179**

□ O/R 28/31; A–VII

Dimensions: 7 x 3.1; with a shed: 8.2 x 3.1 m

*Hut*

The above mentioned postholes form a hut that probably did not have a central row of postholes. Tiny remnants of coal, daub and ceramics that cannot be precisely defined, except that they are made of local VKJ 2 fabric, were found in the backfill of postholes.

**SU 166/167, 184/185, 214/215, 220/221,  
222/223, 224/225, 226/227**

*Fence*

West of the postholes of the hut there are several postholes which may belong to the fence or an earlier building. The initial height of the postholes of the fence is 117.3 cm, and relative depths are approximately 10 cm which is shallower than the postholes dug for the hut.

**SU 226/227, (fig. 46)**

□ P 28; A–VII

▼ 117.30–117.13

*d* – 0.21 m

Two fragments of locally produced pottery, of VKJ 2 and VKJ 29 fabric (which appears in units from the 3<sup>rd</sup> and the 4<sup>th</sup> century).

**SU 152/153, (fig. 46, 58–60)**

□ R 28/29; A–VII

▼ 117.34–117.06

*d* - 1.30 m

*Pit*

Round gray backfill with fragments of daub.

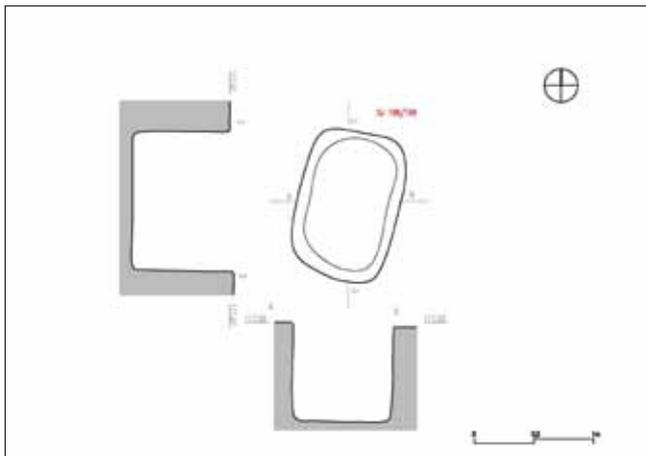

Sl. 57 Ukop SJ 198/199  
Fig. 57 Cut SU 198/199

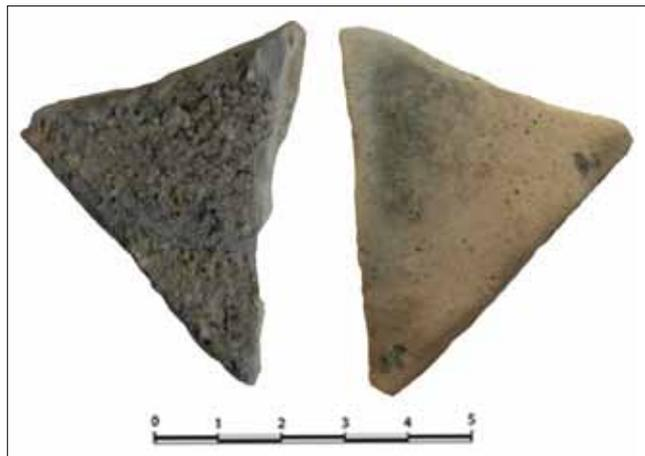

Sl. 58 Ulomak glaziranog tarionika iz SJ 152/153  
Fig. 58 Fragment of a glazed mortar from SU 152/153



Sl. 59 Ukop SJ 152/153 nakon pražnjenja  
Fig. 59 Cut SU 152/153 after emptying

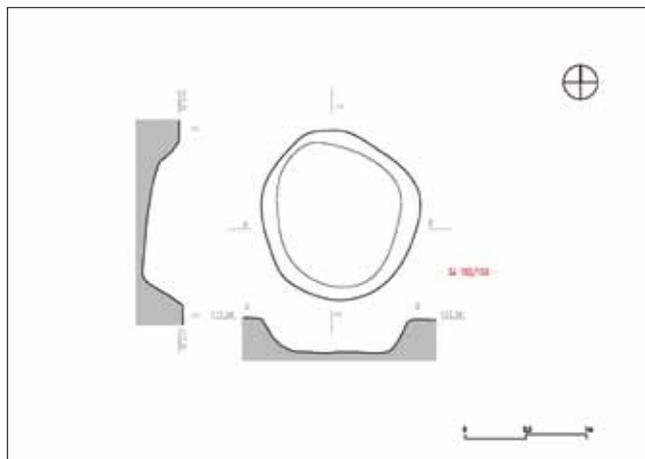

Sl. 60 Tlocrt ukopa SJ 152/153  
Fig. 60 Layout of the cut SU 152/153

ulomak zeleno glaziranog tarionika iz 3.–4. st. (VKJ 13).

**SJ 168/169**, (sl. 46, 61)

□ N 32; S–VII

▼ 117,37–117,08

Dimenzije: 1,98 x 1/1,33 m

*Ostatak radnog prostora*

Zapuna sivkaste boje, nepravilnog oblika.

Pronađeno je svega nekoliko loše očuvanih ulomaka lokalno proizvedene keramike i dva ulomka vrata posude s vodoravnim žlijebovima (T. 14: 8). Ti su ulomci izrađeni od strukture koja nije pronađena na terenu u drugim cjelinama, a ovakvo oblikovanje također nije prisutno. Takvi oblici javljaju se u zapadnoj Panoniji i Noriku. Pored keramike tu je pronađen manji željezni nakovanj (T. 14: 7) (vidi poglavlje 4.3, kat. br. 14) što govori u prilog kako je ovaj dio kompleksa služio kao radni. Na dnu ukopa, na zapadnoj strani, nalazi se stup, koji je možda pripadao nekoj nosivoj konstrukciji ovog radnog prostora.

In this waste-pit, several shapeless fragments of locally produced ceramics (VKJ 2) were found, as well as a fragment of green glazed mortar from the 3<sup>rd</sup>–4<sup>th</sup> century (VKJ 13).

**SU 168/169**, (fig. 46, 61)

□ N 32; A–VII

▼ 117.37–117.08

Dimensions: 1.98 x 1/1.33 m

*Remains of the working premises*

Greyish irregularly shaped backfill.

Only a few poorly preserved fragments of locally produced pottery and two fragments of the neck of a vessel with horizontal channels were found (Pl. 14: 8). These fragments are designed and made of fabric not found in any other unit on the site. Such forms occur in western Panonia and in Noricum. In addition to the pottery, a small iron anvil was found (Pl. 14: 7) (see chapter 4.3, Cat. No. 14), which speaks in favour of this part of the complex being



Sl. 61 SJ 168/169 nakon čišćenja  
Fig. 61 SU 168/169 after emptying

**SJ 174/175;** (sl. 46, 62–63)

□ R 29/30; S–VII

▼ 117,31–116,89

Dimenzije: 1,98 x 2,7/0,93 m

*Ostatak radnog prostora?*

Zapuna izduženog oblika od sive zemlje s lijepom. Na dnu, u sredini i na jugoistočnom dijelu pronađeni su stupovi, vjerojatno dio nosive konstrukcije.

**SJ 190/191,** (sl. 46, 64–65)

□ P 30; S–VII

▼ 117,45–117,21

Dimenzije: 2,94 x 1,50 m

*Ostatak radnog prostora/Spremište?*



Sl. 62 SJ 175 nakon čišćenja  
Fig. 62 SU 175 after the cleanup

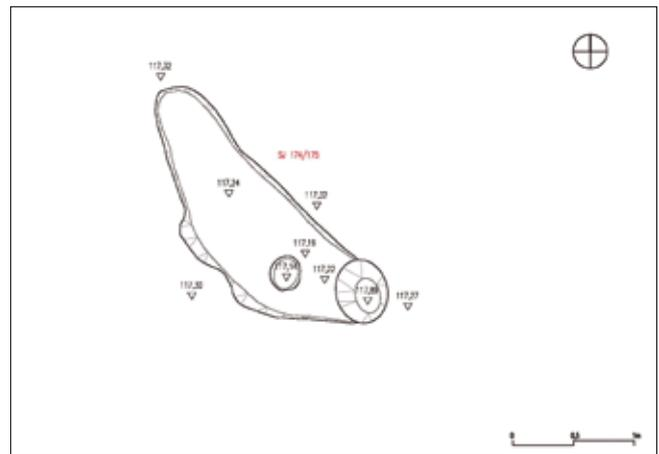

Sl. 63 Tlocrt ukopa SJ 174/175  
Fig. 63 Layout of the cut SU 174/175

used as the work area. At the bottom of the cut, on the west side, there is a posthole, which possibly belonged to a bearing structure of this workspace.

**SU 174/175;** (fig. 46, 62–63)

□ R 29/30; A–VII

▼ 117.31–116.89

Dimensions: 1.98 x 2.7/0.93 m

*Remains of the working premises?*



Sl. 64 SJ190/191, pogled prema sjeveru  
Fig. 64 SU 190/191, view to the north



Zapuna je pjeskovita s malo gara i lijepa, sive boje.

Pronađena je veća količina ulomaka posuđa lokalne proizvodnje (VKJ 2). Izdvajaju se ulomak lonca (T. 14: 9), poklopca P2 (T. 14: 10) i dno (T. 14: 11). Od biljnih ostataka pronađeni su proso, žitarice i razni korovi (vidi poglavlje 5.2, tablica 8 / II dio).

Kompleks 6 (sl. 66), slično kao i prethodni, sastoji se od stupova koji su činili kolibu i nekoliko manjih jama za otpad i dijelova radnih prostorija. Koliba nije imala središnji red stupova, a njezin krov bio je na jednu vodu. Nalazi iz ovog kompleksa datiraju ga u 3.–4. st. prije svega radi nalaza keramike.

### Kompleks 7 (sl. 67)

U ovom kompleksu rekonstruirane su četiri građevinske faze kojima pripadaju nadzemni objekti – kolibe od kojih smo pronašli samo stupove. Objekti su imali središnji red stupova. Zapadni objekt bio je orijentiran u smjeru sjever-jug, dok su ostali bili orijentirani u smjeru zapad-istok.

Također se naziru ostaci manjeg objekta, na istočnom dijelu, koji nije imao središnji red stupova.

Kompleks se, slično kao i prethodni, sastoji od stupova koji su činili kolibu i nekoliko manjih jama ili dijelova radnih prostorija.

**SJ 256/257, 274/275, 278/279, 306/307,  
356/357, 358/359, 364/365, 455/456,  
457/458, 459/460, 461/462, 469/470,  
479/480, 489/490, 493/494**

□ M/N 26/27/28; S–VII

Dimenzije: 7,76 x 9,5 m

Zapadna koliba

Koliba koja se sastojala od ovih stupova imala je središnju gredu i bila je orijentirana u smjeru sjever-jug. U stupovima koji su pripadali ovoj kolibi nisu pronađeni nalazi koji bi omogućili datiranje ovog objekta.

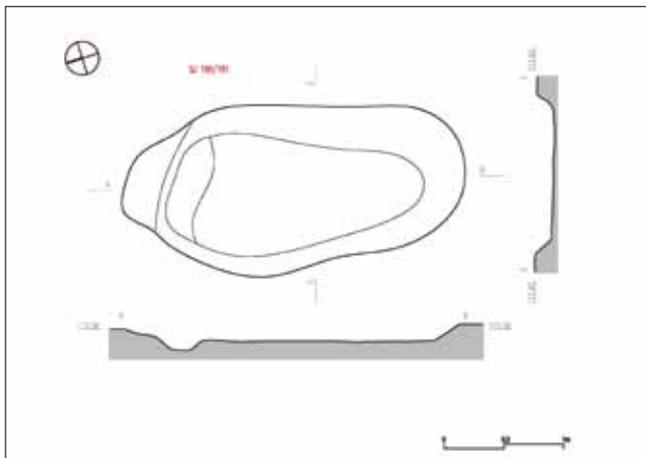

Sl. 65 Tlocrt ukopa SJ 190/191  
Fig. 62 SU 190/191 after the cleanup

Elongated backfill of gray earth with daub. At the bottom, in the middle and on the south-eastern part, postholes which were probably a part of the bearing construction were discovered.

**SU 190/191**, (fig. 46, 64–65)

□ P 30; A–VII

▼ 117.45–117.21

Dimensions: 2.94 x 1.50 m

*Remains of the working premises / Storage room ?*

Gray sandy backfill with some soot and daub.

A large amount of fragments of locally produced dishes (VKJ 2) was found. A fragment of a pot (Pl. 14: 9), the lid P2 (Pl. 14: 10) and a base (Pl. 14: 11) can be singled out. Plant remains include millet, cereals and various weeds (see chapter 5.2, Table 8 / part II).

Complex 6 (fig. 66), similar to the previous one, consists of postholes which formed the hut and several small waste pits and parts of working premises. The hut did not have a central row of postholes, and its roof was mono-pitched. Findings from this complex, mainly ceramic findings, date it to the 3<sup>rd</sup> to the 4<sup>th</sup> century.

### Complex 7 (fig. 67)

In this complex four construction stages involving the above-ground structures were reconstructed - i.e. the huts of which only postholes were found. Structures had a central row of postholes. The structure on the west side was oriented north to south, while the others were oriented in the west-east direction.

On the east side, the remains of a smaller building, which did not have a central row of postholes, can also be observed.

The complex, similarly to the previous one, consists of postholes which formed the hut and several small pits or parts of working premises.



Sl. 66 Pogled iz zraka na kompleks 6, Sektor VII  
Fig. 66 Aerial view of complex 6, area VII



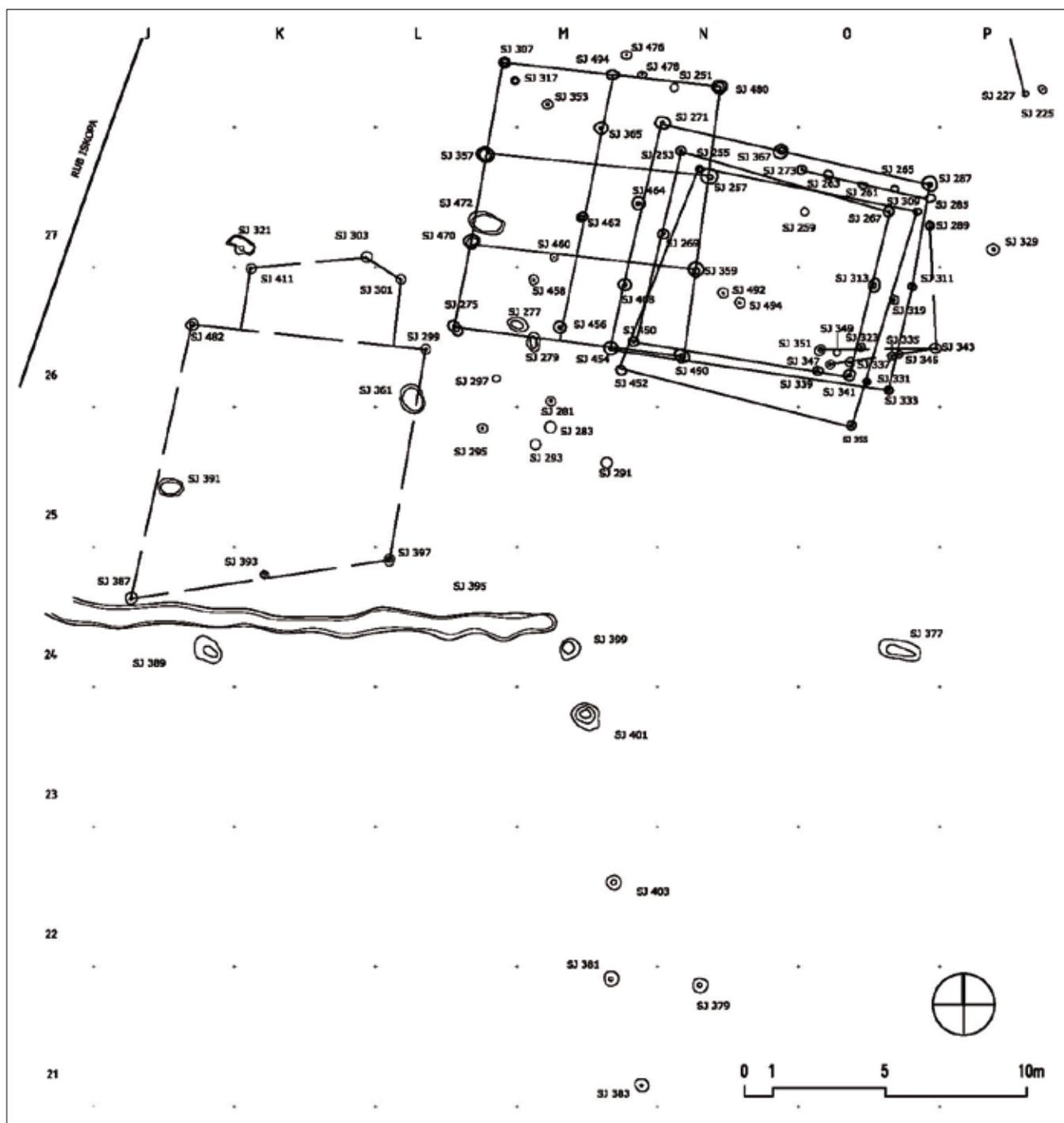

Sl. 67 Tlocrt sjevernog dijela lokaliteta, kompleksi 7 i 8 (sektori VII i VIII)  
 Fig. 67 Layout of the northern part of the site, complexes 7 and 8 (areas VII and VIII)

**SJ 270/271, 286/287, 366/367,  
 453/454, 463/464, 467/468,**

□ M/N/O 26/27; S-VII

Dimenzije: 8,1 x 9,60 m

*Istočna koliba 1 (od zapada prema istoku)*

Na sjevernom dijelu nalazi se više stupova, a možda i tragovi popravljanja objekta ili njegovog dodatnog učvršćivanja: SJ 260/261, 262/263, 264/265, 272/273, 284/285.

**SU 256/257, 274/275, 278/279, 306/307,  
 356/357, 358/359, 364/365, 455/456,  
 457/458, 459/460, 461/462, 469/470,  
 479/480, 489/490, 493/494**

□ M/N 26/27/28; A-VII

Dimensions: 7.76 x 9.5 m

*Western hut*

A hut consisting of these postholes had a central beam and was oriented north-south. Inside the postholes, which belonged to this hut, there were no findings which

**SJ 463/464**

- M 27; S–VII
- ▼ 117,4–117,0
- d* – 0,44 m
- Stup kolibe*

U zapuni stupa pronađen je lijep i ulomci lokalno proizvedene (VKJ 2) keramike.

**SJ 252/253, 266/267, 268/269, 312/313, 340/341, 449/450**

- M/N/O 26/27; S–VII
- Dimenzije: 7,7 x 6,89 m

*Istočna koliba 2 (od zapada prema istoku)*

Riječ je o kolibi koja je vjerojatno imala središnju gredu orijentiranu u smjeru zapad-istok (SJ 268/269–312/313).

**SJ 266/267**

- O 26/27; S–VII
- ▼ 117,29–117,03
- d* – 0,36 m

*Stup kolibe*

Zapuna stupa od sive zemlje s lijepom i garom. Pronađena su dva ulomka lokalno izrađene keramike (VKJ 2 i 14) i dva ulomka posude od dobro pročišćene glinene oker boje s tragom crvenog slikanja koja nije lokalne proizvodnje i nema analogne strukture na lokalitetu.

**SJ 340/341**

- O 26; S–VII
- ▼ 117,20–116,96
- Dimenzije: *d* – 0,37 cm

Zapuna stupa od sive zemlje s garom. Tu su pronađena dva ulomka lokalno proizvedene keramike (VKJ 2), (T. 15: 1–2).

**SJ 254/255, 308/309, 318/319, 330/331, 354/355, 451/452**

- M/N/O 25/26/27; S–VII
- Dimenzije: 7,88 x 7,70 m

*Istočna koliba 3 (od zapada prema istoku)*

Dimenzije kolibe upućuju na to da je objekt morao imati i središnji red stupova radi rasterećivanja krova. U stupovima čije su zapune sivopepeljaste, osim sitnih ulomaka lijepa i gara nije bilo drugih nalaza.

**SJ 288/289, 322/323, 334/335, 336/337, 342/343, 346/467, 348/349, 350/351**

- N/O 26/27; S–VII
- Dimenzije: 4,29 x 4,23 m
- Najistočniji (pomoćni) objekt*

Zapune ovih plitkih stupova od sive su, pepeljaste zemlje, s mrvicama gara i lijepa. Riječ je o manjem, moguće pomoćnom objektu zapadne kolibe. Ovaj pomoćni objekt na južnom je dijelu imao popravke jer se tamo uočava više stupova.

would enable the dating of this object.

**SU 270/271, 286/287, 366/367, 453/454, 463/464, 467/468,**

- M/N/O 26/27; A–VII
- Dimensions: 8.1 x 9.60 m
- Eastern hut 1 (from west to east)*

On the northern part there are more postholes and possibly some traces of repair or its further reinforcement: SU 260/261, 262/263, 264/265, 272/273, 284/285.

**SU 463/464**

- M 27; A–VII
- ▼ 117,4–117,0
- d* – 0,44 m
- Hut posthole*

In the backfill of the posthole, daub and fragments of locally produced (VKJ 2) pottery were found.

**SU 252/253, 266/267, 268/269, 312/313, 340/341, 449/450**

- M/N/O 26/27; A–VII
- Dimensions: 7.7 x 6.89 m
- Eastern hut 2 (from west to east)*

It is a hut which probably had a central beam oriented from west to east (SU 268/269–312/313).

**SU 266/267**

- O 26/27; A–VII
- ▼ 117,29–117,03
- d* – 0,36 m

*Hut posthole*

Gray earth backfill with daub and soot. Two fragments of locally produced pottery (VKJ 2 and 14) were found as well as two fragments of a vessel made of well refined ochre clay with traces of red painting which is not locally produced and has no fabric analogies on the site.

**SU 340/341**

- O 26; A–VII
- ▼ 117,20–116,96
- Dimensions: *d* – 0.37 cm
- Hut posthole*

Gray earth posthole backfill with soot. Two fragments of locally produced pottery (VKJ 2) were found here (Pl. 15: 1–2).

**SU 254/255, 308/309, 318/319, 330/331, 354/355, 451/452**

- M/N/O 25/26/27; A–VII
- Dimensions: 7.88 x 7.70 m
- Eastern hut 3 (from west to east)*

Dimensions of the hut indicate that the structure must have had a central row of postholes in order to carry the



U ovom kompleksu nisu pronađeni arheozoološki i arheobotanički ostaci, a drugi arheološki nalazi malobrojni su i nisu pogodni za datiranje pojedinih koliba. S obzirom na prisutnost više koliba, možemo samo zaključiti kako je prostor bio zaposjednut duže vrijeme i izložen brojnim pravcima i obnovama.

### Kompleks 8 (sl. 67)

Ovo je najjužniji kompleks na sjevernom dijelu lokaliteta, u sektoru VIII. Sastoji se od kolibe s ulazom i trijemom na sjeveru. Istočno se nalaze stupovi za koje nije jasno pripadaju li kompleksu 7 ili 8, koji su mogli činiti manji objekt dimenzija 2 x 1,6 m: SJ 280/281, 282/283, 292/293, 294/295, 296/297.

Javlja se još nekoliko manjih jama SJ 320/321, 360/361, 390/391 i ograda 378/379, 380/381, 382/383, 388/389, 394/395, 398/399, 400/401, 402/403.

### SJ 298/299, 386/387, 392/393, 396/397, 481/482, 410/411, 300/301

□ J/K/L 24/25/26/27; S–VIII

Dimenzije: 9,7 x 8,7 m, dužina s nadstrešnicom 12,3 m  
*Koliba*

Stupovi su vrlo plitko očuvani te je moguće da je dio njih, naročito onih koji bi trebali biti u sredini (sjever-jug), nije očuvan.

### SJ 320/321

□ J/K 27; S–VIII

▼ 117,52–117,4

Dimenzije: 0,95x0,61 m

*Jama*

Zapuna od sive zemlje. S južne strane nalazi se stup. Pronađeno je dosta lijepa i keramike. Od posuđa pronađeno je dno posude lokalne izrade kat. br. 111 (T. 15: 3).

### SJ 360/361, (sl. 68–69)

□ L 26; S–VIII

▼ 117,53–117,48

Dimenzije: 0,81 x 1,05 m

*Jama*

U plitkoj jami pronađeno je 5 ulomaka velike zdjele Z 4, kat. br. 112 (T. 15: 4), datirane u 3.–4. st., VKJ 2 strukture, te ostaci korova (vidi poglavlje 5.2, tablica 8 / II dio).

### SJ 394/395

□ I/M 24; S–VIII

▼ 117,53–117,45

Dimenzije: 18,10 x 0,80 m

*Ograda*

Zapuna od sive zemlje sa malo ugljena. Ukop se pruža u smjeru zapad-istok, presječen je ukopom za struju. U □ L 24 nalazi se udubljenje s puno ugljena i većom koncentracijom.

roof. In ashen gray backfill of the postholes there were no other finds apart from daub and soot.

### SU 288/289, 322/323, 334/335, 336/337, 342/343, 346/467, 348/349, 350/351

□ N/O 26/27; A–VII

Dimensions: 4.29 x 4.23 m

*Easternmost (auxiliary) structure*

Backfill of these shallow postholes consists of gray, ashy earth, with crumbs of soot and daub. This is a smaller, possibly auxiliary building of the western hut. This auxiliary building had repairs in the southern part since extra postholes were observed there.

In this complex no archaeozoological and archaeobotanical remains were found and other archaeological finds are scarce and unsuitable for dating of individual huts. Given the presence of several huts, we can only conclude that the area had been inhabited for a long period of time and subjected to numerous repairs and renovations.

### Complex 8 (fig. 67)

This is the southernmost complex on the northern part of the site, in the area VIII. It consists of a hut with an entrance and a porch on the north. On the east side, there are postholes which could have formed a small building measuring 2 x 1.6 m; it is not clear if they belonged to complex 7 or complex 8: SU 280/281, 282/283, 292/293, 294/295, 296/297.

There are also few smaller pits SU 320/321, 360/361, 390/391 and 378/379 and a fence 380/381, 382/383, 388/389, 394/395, 398/399, 400/401, 402/403.

### SU 298/299, 386/387, 392/393, 396/397, 481/482, 410/411, 300/301

□ J/K/L 24/25/26/27; A–VIII

Dimensions: 9.7 x 8.7 m, length with a porch 12.3 m

*Hut*

The conservation status of the very shallow postholes suggests that those situated in the middle have been completely deteriorated.

### SU 320/321

□ J/K 27; A–VIII

▼ 117.52–117.4

Dimensions: 0.95 x 0.61 m

*Pit*

Gray earth backfill. Posthole on the south side. Quite a lot of daub and pottery was found including the base of a locally produced vessel Cat. No. 111 (Pl. 15: 3).

### SU 360/361, (fig. 68–69)

□ L 26; A–VIII

▼ 117.53–117.48



tracijom nalaza keramike, grube strukture, crvene do crne boje. Pronađeni su ulomci lokalno proizvedene keramike (VKJ 2, 14).

U ovom dijelu nalazi se srednjovjekovna jama SJ 368/369 koja je vjerojatno presjekla neku antičku cjelinu budući da je u njoj pronađeno i antičkog materijala. Među njima ističe se ulomak keramičkog pršljena (T. 15: 5). U ovom kompleksu pronađeni su malobrojni nalazi. Zdjela iz SJ 360/341 i struktura keramike VKJ 14 iz 394/395 govore u prilog dataciji kompleksa u 3.–4. st.

### Kompleks 9

Unutar kompleksa 9 uočava se više stupova čiji se odnosi ne mogu utvrditi sa sigurnošću. Osim njih, uočen je veći objekt nejasne namjene i nepravilnog oblika - SJ 642/642. Pronađeni su i struktura za pripremu hrane SJ 630/631 te ognjište SJ 634/635+1463+1464.

#### SJ 642/643, (sl. 6, 70–71)

□ E/F 3/4; S–XIV

▼ 117,95–117,77

Dimenzije: 5,80 x 5,32 m

#### Objekt

Zapuna nepravilnog oblika tamnosive boje. Nakon pražnjenja zapune na dnu ukopa uočene su zapune stupova: 1465/1466, 1467/1468, 1469/1470, SJ 1471/1472, 1473/1474, 1477/1478, 1481/1482, 1483/1484, 1485/1486. Na dnu zapune pronađeni su stupovi: na istočnom dijelu u smjeru sjever-jug 1469/1470, 1467/1468, 1465/1466; na sjeverozapadnom dijelu u smjeru zapad-istok 1477/1478, 1471/1472, 1473/1474, u srednjem dijelu u smjeru zapad-istok 1481/1482, 1483/1484, 1485/1486. Stupovi su izrazito sive boje s garom, ali, u odnosu na zapunu objekta SJ 642/643, pepeljaste i svjetlije boje. Vjerojatno su dio starijeg, nadzemnog objekta, moguće kolibe.

U zapuni SJ 642 je pronađena je veća količina keramike, uglavnom lokalne proizvodnje (VKJ 2), lonaca L5 (T.

Dimensions: 0.81 x 1.05 m

#### Pit

In a shallow pit five fragments of a large bowl Z4, Cat. No. 112 (Pl. 15: 4), dated to the 3<sup>rd</sup> and 4<sup>th</sup> century, of VKJ 2 fabric were found, as well as the weed remains (see chapter 5.2, Table 8/part II).

#### SU 394/395

□ I/M 24; A–VIII

▼ 117.53–117.45

Dimensions: 18.10 x 0.80 m

#### Fence

Gray earth backfill with some coal. The cut stretches in west–east direction; it was intersected by the cut for the power cable. In □ L 24 there is a recess with a lot of coal and a higher concentration of red to black coarse fabric ceramics. Also found are fragments of locally produced ceramics (VKJ 2, 14).

In this part, a medieval pit SU 368/369 is located which probably cut through some ancient unit since antique materials were found in it. Among them is a fragment of a ceramic whorl (Pl. 15: 5). There were not many findings in this complex. A bowl from SU 360/341 and the ceramics fabric VKJ 14 from 394/395 both speak in favour of dating this complex to the 3<sup>rd</sup>–4<sup>th</sup> century.

### Complex 9

Within complex 9, several postholes can be noticed but it can not be determined how they were linked together. Apart from them, there was also a large, irregularly shaped object of undetermined purpose SU 642/642. Structure for food preparation SU 630/631 and a hearth SU 634/635+1463 +1464 were also found.

#### SU 642/643, (fig. 6, 70–71)

□ E/F 3/4; A–XIV

▼ 117.95–117.77

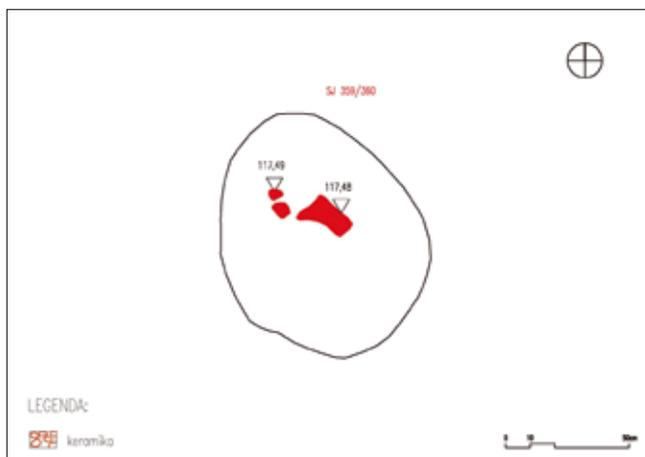

Sl. 68 Nalaz zdjele *in situ* (PN 21) u SJ 360/361  
Fig. 68 Finding of a bowl *in situ* (SF 21) in SU 360/361



Sl. 69 Nalaz zdjele *in situ* (PN 21) u SJ 360/361  
Fig. 69 Finding of a bowl *in situ* (SF 21) in SU 360/361



Sl. 70 SJ 642/643 nakon čišćenja  
Fig. 70 SU 642/643 after the cleanup



Sl. 71 Dno SJ 642/643, sa zapunama stupova  
Fig. 71 The bottom of SU 642/643 with posthole backfills

15: 6–8), kasnoantičkih tarionika Tr1 (T. 15: 11–12) (VKJ 16) i malo ulomaka uvozne keramike (T. 15: 13–14). Uz keramiku pronađena je troska i mrvice ugljena. Dio je keramike narančasto svijetlocrvene boje pečenja dobro pročišćene strukture. Pronađeni su ostaci prosa (vidi poglavlje 5.2, tablica 8 / III dio) i životinjskih kostiju (vidi poglavlje 5.1, tablica 5). Uz to i manja količina lijepa te dva željezna predmeta nejasne namjene (T. 15: 15–16), (vidi poglavlje 4.3, kat. br. 15–16) od kojih je jedan možda dio sječiva noža (T. 15: 16).  
Objekt je nalazima datiran u 3.–4. st.

#### **SJ 630/631**, (sl. 6, 72–78)

□ E/F 3; S–XIV

▼ 117,99–117,85

*d* – 1 m

*Struktura za pripremu hrane*

Zapuna pravokutnog oblika, zaobljenih rubova puno lijepa i gara. Sve je vrlo kompaktno i nabijeno.

Ispod krupnih komada lijepa (T. 25: 6a–6b; sl. 74) koji su bili na vrhu, pronađen je sitniji i tanji lijep (T. 25: 3–5), (vidi poglavlje 3.7), puno ugljena i zapečena zemlja crvene i crne boje. Nađeni su i ostaci cijelih pougljenjenih daščica. Ispod ulomaka lijepa i gara nalazila se djelomično zapečena zemlja u središnjem dijelu ukopa (sl. 75–76).

Ulomci lijepa imaju pravilan oblik (T. 25: 6a–6b) te se pretpostavlja kvadratna struktura. Na nekim ulomcima uočava se plitak, nepravilan žlijeb, koji prati rub. Donja strana, koja je grublje izvedena, nemarno je zaravnjena, crne je do sive boje. Gornja strana pravilno je zaravnjena i crveno je pečena. Pored ovih velikih i pravilnih komada uočeni su i manji ulomci lijepa, sive do crne boje s tragovima tankih šiba. Jedna strana je zaglađena, a na drugoj su negativni tankih grančica.

Pronađena keramika pripada vrlo usitnjenim ulomcima čiji se oblik ne može definirati, a pripada VKJ 2 strukturi.

U cjelini SJ 630/631 pronađeno je najviše građevinskih elemenata koji omogućuju pretpostavku kako je ona izgledala. Ostaci pravokutne konstrukcije od pečene gli-

Dimensions: 5.80 x 5.32 m

*Structure*

Irregularly shaped dark gray backfill. After emptying the backfill at the bottom of the cut backfills of postholes were observed: SU 1465/1466, 1467/1468, 1469/1470, 1471/1472, 1473/1474, 1477/1478, 1481/1482, 1483/1484, 1485/1486. Postholes were found at the bottom of the backfill: in the eastern part from the north to the south 1469/1470, 1467/1468, 1465/1466; in the north–western part in a west–east direction 1477/1478, 1471/1472, 1473/1474; in the middle in a west–east direction 1481/1482, 1483/1484, 1485/1486. The postholes are distinctly gray with soot, but, compared to backfill of the structure SU 642/643, more ashen and lighter in colour. It was probably a part of an older, above-ground object, possibly a hut.

In the backfill SU 642, a larger quantity of pottery was found. It was mostly locally produced pottery (VKJ 2), pots L5 (Pl. 15: 6–8), late Antique mortars Tr 1 (Pl. 15: 11–12) (VKJ 16) and a few fragments of imported ceramics (Pl. 15: 13–14). In addition to ceramics, slag and coal crumbs were also found. Part of the ceramic is of an orange light red firing colour and well refined fabric. Remains of millet (see chapter 5.2, Table 8 / part III) and animal bones (see chapter 5.1, Table 5) were discovered as well and, in addition, a smaller quantity of daub and two iron items of undetermined purpose (Pl. 15: 15–16) (see chapter 4.3, Cat. Nos. 15–16), one of which is perhaps part of the knife blade (Pl. 15: 16).

According to finds, the structure is dated to the 3<sup>rd</sup>–4<sup>th</sup> century.

#### **SU 630/631**, (fig. 6, 72–78)

□ E/F 3; A–XIV

▼ 117,99–117,85

*d* – 1 m

*Food preparation structure*

Backfill or rectangular shape with rounded edges and a lot of daub and soot. The backfill is very solid and compact.

Beneath large pieces of daub (Pl. 25: 6a–6b; fig. 74)

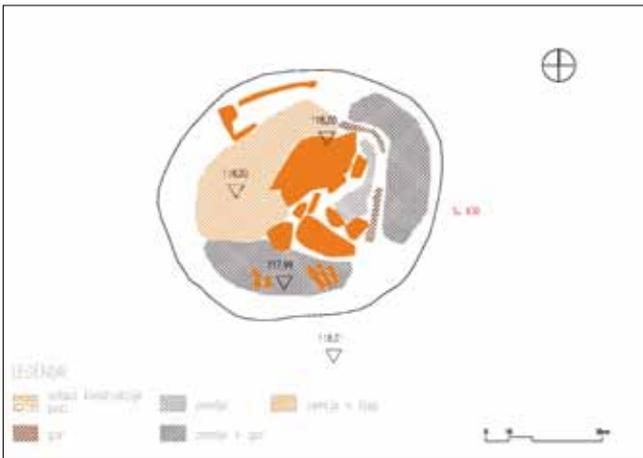

Sl. 72 Tlocrt SJ 630/631 tijekom istraživanja  
 Fig. 72 Layout of SU 630/631 during the excavations

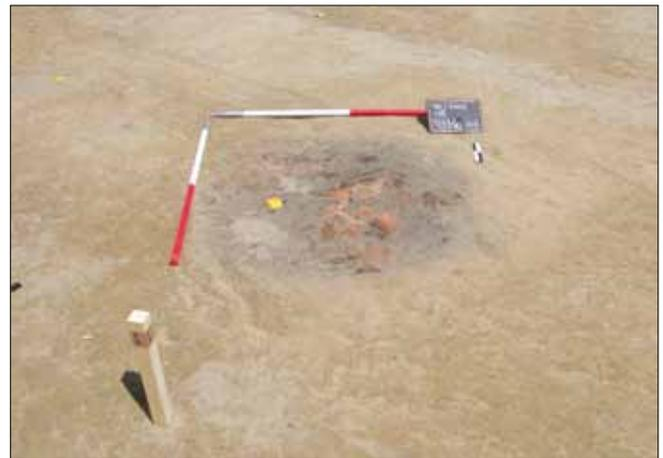

Sl. 73 Zapuna SJ 630/631 nakon poliranja  
 Fig. 73 Backfill SU 630/631 after polishing



Sl. 74 SJ 630/631 tijekom istraživanja, ostaci konstrukcije  
 Fig. 74 SU 630/631 during the excavations, remains of the construction

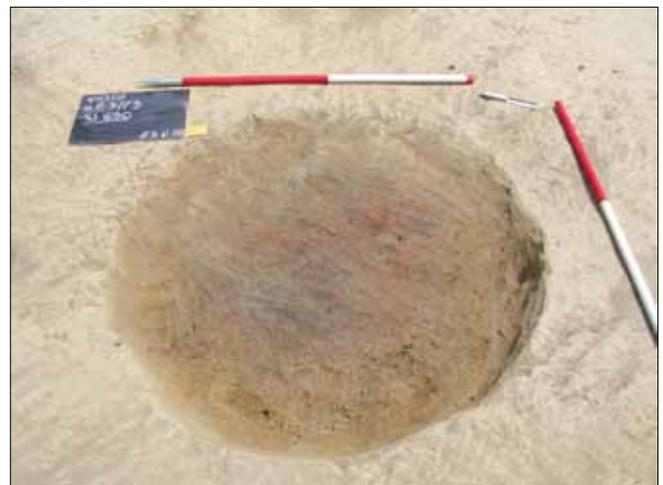

Sl. 75 SJ 630/631 tijekom istraživanja, zapečeno dno  
 Fig. 75 SU 630/631 during the excavations, fired bottom

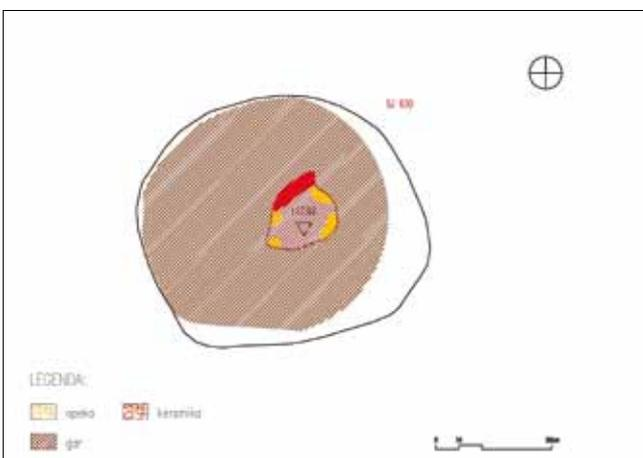

Sl. 76 Tlocrt SJ 630/631 sa zapečenim dnom  
 Fig. 76 Layout of SU 630/631 with fired bottom



Sl. 77 Ukop SJ 630/631  
 Fig. 77 Cut SU 630/631

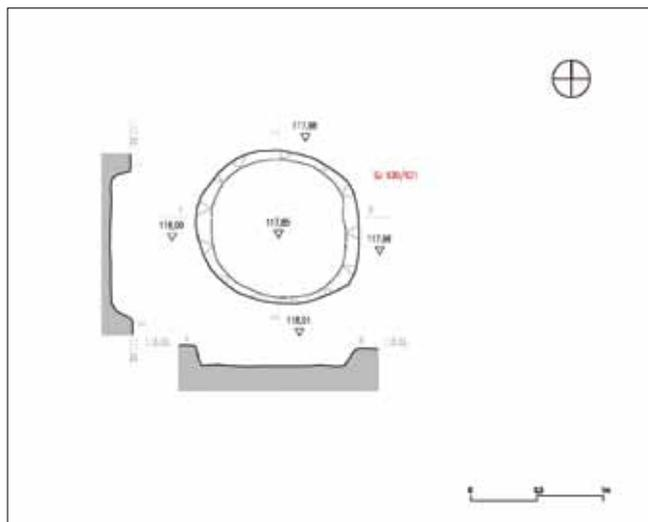

Sl. 78 Tlocrt ukopa SJ 630/631  
Fig. 78 Layout of the cut SU 630/631



Sl. 79 Strukture za pripremu hrane  
Fig. 79 Food preparation structure

ne govore o tome kako je imala pravokutan oblik, ploču na kojoj se pripremala hrana. Tu činjenicu potkrepljuje i nalaz biljnih ostataka u zapuni SJ 630 (ječam, proso, raž, klipasti muhar i dr. žitarice (vidi poglavlje 5.2, Tablica 8 / III dio). Poznato je više primjera (Mauné et al. 2013) izgleda peći za pripremu hrane, ognjišta i krušne peći, ali riječ je o rimskim vilama i urbanim cjelinama. U njima su strukture za kuhanje zidane opekama i većih su dimenzija. Čini ih velika ravna radna ploha za kuhanje i loženje, a ispod nje, nalazi se slobodan prostor za držanje drva. U ovom slučaju nemamo opeke ili kamen već konstrukciju od lijepa koja je jednako kao i opeka mogla držati toplinu.

Budući da dno ukopa SJ 631 nije jako zapečeno, možda su na dno samo odlagali žar i pepeo nakon što je kuhanje bilo gotovo i kada bi čistili ploču za kuhanje. Tinjanje žara i dim su mogli nadimiti donju stranu ploče koja je crna do siva. Nepostojanje protoka zraka ispod ploče ugasio bi preostali žar. Na ploči su mogli zapaliti vatru i na njoj kuhati, slično kao na velikim pećima unutar vila, bilo urbanih, bilo ruralnih. Koliko je visoka bila takva peć ne znamo (sl. 79). Visina od 0,80-1 m je svakako poželjna zbog ergonomije, ali nemamo dovoljno dokaza koji bi to potvrdili. Slična struktura u kompleksu 1 (ukop SJ 005) bi potvrdila ovu pretpostavku budući da je u zapuni SJ 031 pronađena veća količina pepela ispod strukture od lijepa, ali same stijenke ukopa nisu uopće zapečene.

Tanke "pločice" od lijepa koje su na jednoj strani zaglađene, a na drugoj imaju tragove šiblja, nisu u presjeku zaobljene tj. nisu mogle činiti kalotu kakva je postojala kod krušnih peći. Budući da su one pronađene ispod komada koji su činili ravnu ploču za kuhanje i na dnu ukopa, ove „pločice“ s negativima šiblja činile su donji dio konstrukcije od granja i šiblja obloženih blatom. Na taj su način mogle poslužiti istoj svrsi kao i kuhinje pompejskog tipa, unatoč skromnijoj izvedbi. Ovakve jednostavne i priručne kuhinje

which were at the top, smaller and thinner daub was found (Pl. 25: 3–5) (see chapter 3.7), a lot of coal and fired red and black earth. The remains of whole charred planks were found as well. Below fragments of daub and soot, in the central part of the cut, there was partially fired earth (fig. 75–76).

Fragments of daub have a regular shape, (Pl. 25: 6a–6b) which is a sign that the structure was square-cut. On some fragments, a shallow, irregular groove, which follows the edge, can be observed. The lower side is coarser, of black to gray colour and artlessly levelled. Upper side is properly levelled and of red firing colour. In addition to these large and shapely pieces, smaller fragments of daub of gray to black colour with traces of thin twigs were observed. One side is smooth and the other has the negatives of thin twigs.

Ceramics found here consists of very small unidentifiable fragments of VKJ 2 fabric.

In unit SU 630/631, the largest quantity of construction elements was found which allowed us to learn how the object actually looked like. The remains of a rectangular structure made of fired clay show that it had a rectangular shape, i.e. the panel on which the food was prepared. This fact is corroborated by findings of plant remains in the backfill SU 630 (barley, millet, rye, foxtail millet and other cereals (see chapter 5.2, Table 8 / part III). Several examples (Mauné et al. 2013) of how furnaces for food preparation, hearths and wood-fired kilns looked like, but all of them in the Roman Villas, urban areas and none in a village. In those cases cooking structures were made of brick and are larger in size. All consist in a flat rectangular or square working unit with a wood storage space underneath. On this site we do not have bricks or stones, but the construction made of daub which, the same as bricks, could maintain the heat.

Since the bottom of the cut SU 631 is not particularly



danas ponekad izrađuju izviđači, bez oblaganja bočnih stijenki blatom, koristeći samo šiblje i pruće različite debljine. Budući da je ovdje riječ o trajnijoj potrebi, a možda i želji za estetikom, na podkonstrukciju od granja nanošeno je blato koje je zaglađeno. Obložene bočne stijenke imaju smisla, s obzirom na postojanje pliče jame na dnu u kojoj je pronađen gar i zapečeno dno, jer omogućavaju da se u jamu odloži višak gara i pepela.

**SJ 634/635+1463+1464** (sl. 6, 80–87)

□ E 2/3, S–XIV

▼ 118,03–117,85

*d* – 1,40m

*Ognjište*

Zapuna tamnosmeđe boje s puno lijepa. Na vrhu se nalaze nabiti tanki i kompaktni ulomci lijepa SJ 1463, koji leže na ravnoj, zapečenoj podlozi crvene (crvene i narančaste boje) SJ 1464. Na JI dijelu nalazi se stup SJ 1475/1476 kojeg je peč presjekla.

Ravna podloga ispod nakupine lijepa SJ 1464 jako je nabijena i zapečena. S obzirom na to jako zapečeno dno i sitne nepravilne ulomke lijepa pretpostavlja se da nije riječ o strukturi za kuhanje s ravnom plohom kao što je slučaj sa SJ 630/631. Zbog jako zapečene podloge, može se pretpostaviti da se na njoj ložila vatra, a tanki ulomci lijepa mogli su biti dijelovi konstrukcije. Nažalost, ostaci hrane u ovoj cjelini nisu pronađeni.

**SJ 636/637**, (sl. 6)

□ E 3, S–XIV

▼ 118,01–117,77

*d* – 0,60 m

*Jama*

S južne strane objekta SJ 642/643 nalazi se jama. Zapuna je sive boje s mrvicama gara i lijepa. Nalazi su vrlo usitnjeni, a izdvaja se ulomak dna antičke staklene posude (T. 15: 17) (vidi poglavlje 4.1, kat. br. 4).



Sl. 80 Zapuna SJ 634/635  
Fig. 80 Backfill SU 634/635

baked, we think that it was used only for depositing ashes after the cooking was over and when they cleaned the cooking panel. Smoulder of ember and smoke could have fumigated the underside of the panel, which is black to gray. Lack of air flow under the plate would have extinguished the remaining ember. They could have light a fire on the panel and cook on it, similar to large furnaces inside villas, both urban or rural. We do not know how tall such furnace would be (fig. 79). No evidence as to the height of the hearth exists, although an ergonomic size of 1 meter seems reasonable. A similar structure in complex 1 (cut SU 005) would confirm this assumption, since is in the backfill SU 031 a large amount of ash was found under the structure made of the daub, but the walls of the cut themselves were not at all baked.

Thin "tiles" made of daub, polished on one side and with traces of wicker on the other, are not rounded in cross-section, i.e. they could not have formed a dome similar to one in bread ovens. Since they were found under pieces which formed a flat cooking surface and at the bottom of the cut, these "tiles" with negatives of wicker probably formed the lower part of the structure made of branches and twigs covered with mud. In this way they could have served the same purpose as Pompeian type kitchens, despite their modest construction. Such simple and small kitchens are nowadays sometimes made by scouts, without coating the sidewalls with mud, using only branches and twigs of different thickness. Being of a more permanent nature, and perhaps even having some aesthetic aspirations, the substructure of branches is coated with mud and then smoothed. The coated sidewalls make sense, given the existence of a shallow pit on the bottom where soot and a burnt bottom were uncovered, because they would allow excess of soot and ash to be deposited in the pit.

**SU 634/635+1463+1464** (fig. 6, 80–87)

□ E 2/3, A XIV

▼ 118.03–117.85



Sl. 81 SJ 634/635 s lijepom SJ 1463  
Fig. 81 SU 634/635 with daub SU 1463



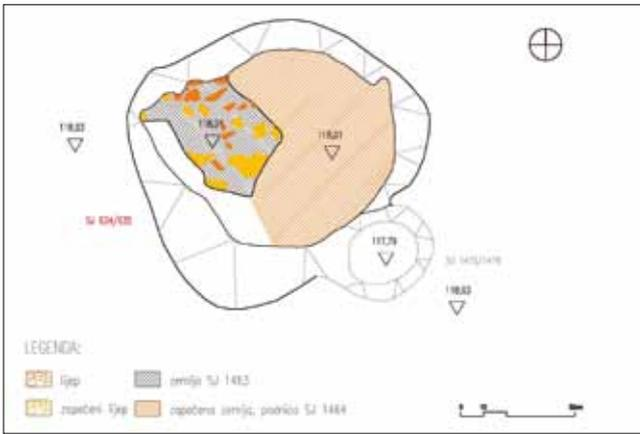

Sl. 82 Tlocrt SJ 634/635 s lijepom SJ 1463  
Fig. 82 Layout of SU 634/635 with daub SU 1463



Sl. 83 SJ 634/635 sa zapečenom zemljom SJ 1464  
Fig. 83 SU 634/635 with burned earth SU 1464

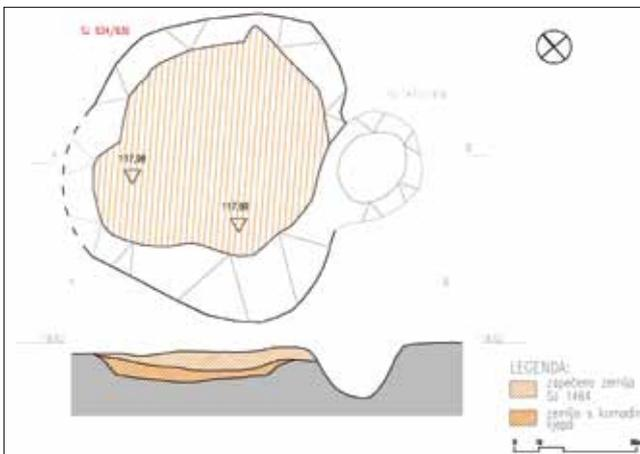

Sl. 84 Tlocrt SJ 634/635 sa zapečenom zemljom SJ 1646  
Fig. 84 Layout of SU 634/635 with burned earth SU 1646



Sl. 85 Presjek SJ 1646 u SJ 635  
Fig. 85 Cross-section of SU 1646 in SU 635

### SJ 626/627 (sl. 6)

□ G 2; S–XIV

▼ 118,01–117,76

d – 0,35 m

Jugoistočno od SJ 642/643, nalazi se stup u kojemu je pronađeno sječivo (T. 15: 18) (vidi poglavlje 4.6, kat. br. 1).

### SJ 652/653, (sl. 6, 88)

□ D/E 4; S–XIV

▼ 117,93–117,29

Dimenzije: 2,42 x 1,21 m

Jama

Zapuna nepravilnog oblika sive boje, masna i rahla. Ima vrlo malo keramike. Moguće je da je bila dio cjeline, zajedno sa SJ 642/643.

## 2.3.2. Druge arheološke cjeline

U nastavku teksta obrađuju se one arheološke cjeli-

d – 1.40m

Hearth

Dark brown backfill with lots of daub. At the top, there are solid thin and compact fragments of daub SU 1463, which lie on a flat, fired red foundation (red and orange) SU 1464. On the SE part there is a posthole SU 1475/1476 cut through by the hearth.

Flat surface beneath clusters of daub SU 1464 is very compact and burned. Given the well burned bottom and tiny irregular fragments of daub, it is likely that this is not a cooking structure with flat surfaces, as is the case with SU 630/631. The burned surface may indicate that it was used as a fire-place, while the thin fragments of daub could be parts of the structure. Unfortunately, no edibles were detected in this unit.

### SU 636/637 (fig. 6)

□ E 3; A–XIV

▼ 118,01–117,77

d – 0.60 m

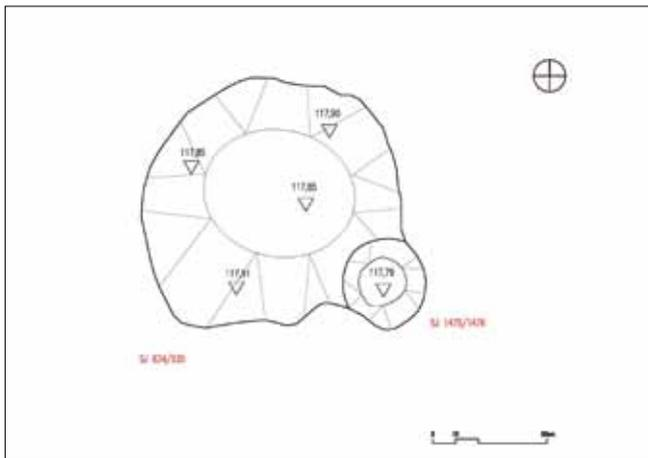

Sl. 86 Tlocrt ukopa SJ 634/635  
Fig. 86 Layout of the hut SU 634/635



Sl. 87 Rekonstrukcija ognjišta  
Fig. 87 A reconstruction of the hearth

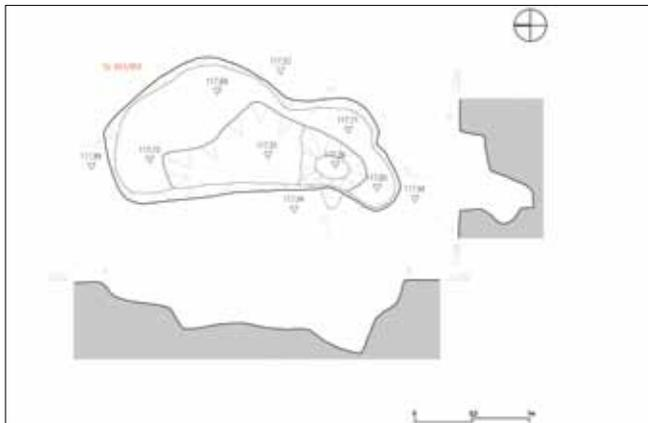

Sl. 88 Tlocrt i presjeci jame SJ 652/653  
Fig. 88 Layout and cross-sections of SU 652/653



Sl. 89 SJ 674/675 nakon pražnjenja zapune  
Fig. 89 SU 674/675 after emptying of the backfill

ne u kojima su pronađeni nalazi indikativni za datiranje i tumačenje lokaliteta. Ne obrađuju se svi objekti koji su pronađeni na lokalitetu, a naročito ne stupovi, budući da u većem broju nije bilo nalaza koji bi bili dovoljno očuvani da omoguće detaljnu obradu. Znamo da su stupovi arheološkog porijekla, a ne geološkog, budući da su u njima redovito nalaženi sitni ulomci ugljena, lijepa i keramike.

#### **SJ 662/663**

□ D 2/3; S–XIV

▼ 118,07–117,60

Dimenzije: 0,65 x 0,50 m

Zapuna sive boje čiji ukop možda čini dio ograde sa stupovima SJ 666/667, 664/665, 662/663. U zapuni je od nalaza pronađen samo odbojak (T. 15: 19), (vidi poglavlje 4.6. kremen: kat. br. 2).

#### **SJ 674/675** (sl. 89–90)

□ C 4; S–XIV

▼ 118,03–117,7 m

#### *Pit*

On the southern side of structure SU 642/643 there is a pit. Its backfill is gray with crumbs of soot and daub. Findings are very fragmented, and a fragment of a base of an antique glass vessel draws one's attention (Pl. 45: 17) (see chapter 4.1, Cat. No. 4).

#### **SU 626/627**, (fig. 6)

□ G 2; A–XIV

▼ 118.01–117.76

d – 0.35 m

Southeast of SU 642/643 there is a posthole within which a blade was found (Pl. 15: 18) (see chapter 4.6, Cat. No. 1).

#### **SU 652/653**, (fig. 6, 88)

□ D/E 4; A–XIV

▼ 117.93–117.29

Dimensions: 2.42 x 1.21 m

*Pit*



$d - 2,68 \text{ m}$

*Jama*

Zapuna je glinasta, sive boje, a ugljen se nalazi samo u tragovima. Jama je nepravilnog kružnog oblika.

U njoj je pronađena keramika lokalne proizvodnje (VKJ 2), lijep i ulomci sivo pečene panonske keramike (VKJ 4). Od keramike se izdvajaju L1 i 2 lonci (T. 16: 1–2), poklopac P3 (T. 16: 3) i zdjela Z2 (T. 16: 4). Ulomci pronađene sive panonske keramike pripadali su vrčevima ili loncima.

**SJ 732/733** (sl. 6, 91)

□ C 1/2; S–XIV

▼ 118,11–117,05

$d - 1,54 \text{ m}$

*Jama*

Zapuna od sive zemlje s ulomcima lijepa i mrvicama ugljena, keramike i životinjskih kostiju.

Većina keramičkih nalaza pripada lokalno proizvedenom posuđu VKJ 2 strukture, a manji dio posuđu VKJ 24 strukture. Nekoliko ulomaka nedefiniranog je oblika posuđa izrađenih od VKJ 13 strukture. Pronađen je i ulomak čaše s naborima (T. 16: 5). U jami su pronađene kosti ovce ili koze (vidi poglavlje 5.1, tablica 5, 6).

**SJ 754/755**, (sl. 6)

□ B 2; S–XIV

▼ 118,220–117,91

Dimenzije: 3,08 x 0,78 m

Zapuna nepravilnog oblika s tamnom sivom zemljom, mrvicama ugljena, pepeljasta. Na dnu su pronađeni stupovi SJ 1487/1488, 1489/1490, 1494/1495.

U zapuni su pronađeni keramika i lijep. Pronađeno je dno posude izrađene od VKJ 2 strukture i profilirana ručka amfore VKJ 13 strukture.

Irregularly shaped gray, sticky, loose backfill. Small quantities of ceramics. It is possible that this pit is a part of a unit, together with SU 642/643.

### 2.3.2. Other archaeological units

In the following pages, the archaeological units are described in which findings indicative for dating and interpretation of the site were discovered. Not all the objects found at the site are processed, in particular the postholes, since most of them are not sufficiently preserved to allow detailed analysis. We know that the postholes are of an archaeological origin, and not geological, considering that many small fragments of coal, daub and ceramics are usually found within them.

**SU 662/663**

□ D 2/3; A–XIV

▼ 118.07–117.60

Dimensions: 0.65 x 0.50 m

Gray backfill whose cut may form a part of the fence with postholes SU 666/667, 664/665, 662/663. Only a flake was found in the backfill (Pl. 15: 19) (see chapter 4.6, quartz: Cat. No. 2).

**SU 674/675** (fig. 89–90)

□ C 4; A–XIV

▼ 118.03–117.7 m

$d - 2.68 \text{ m}$

*Pit*

Gray, clayish backfill with coal only in traces. The pit is of irregular circular shape.

Locally produced pottery of (VKJ 2), daub and fragments of gray fired Pannonian ceramics (VKJ 4) were found in it. Pots L1 and 2 (Pl. 16: 1–2), a lid P 3 (Pl. 16: 3) and a bowl Z 2 (Pl. 16: 4) stand out. Fragments of Pannonian gray pottery are parts of jugs or pots.

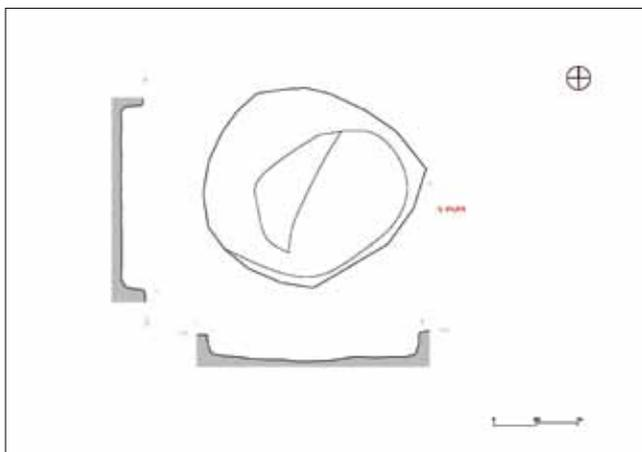

Sl. 90 Jama SJ 674/675 nakon pražnjenja  
Fig. 90 Pit SU 674/675 after the emptying

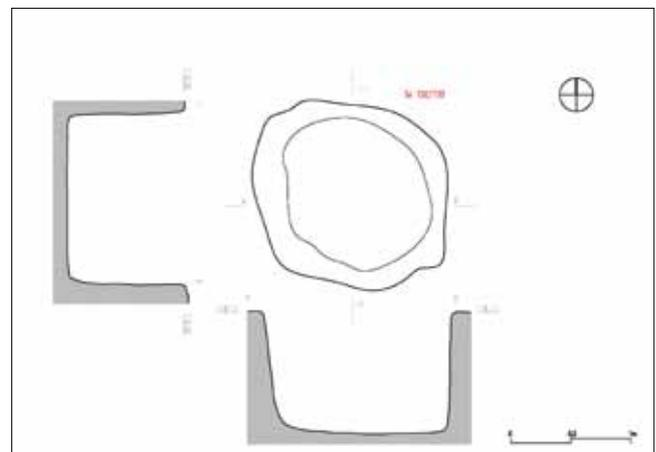

Sl. 91 Tlocrt ukopa SJ 732/733  
Fig. 91 Layout of the cut SU 732/733

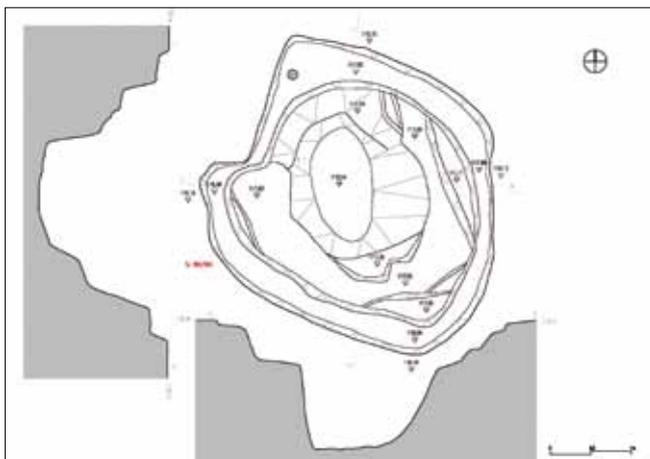

Sl. 92 Tlocrt ukopa SJ 802/803  
Fig. 92 Layout of the cut SU 802/803



Sl. 93 Ukop SJ 802/803  
Fig. 93 Cut SU 802/803

### SJ 802/803 (sl. 6, 92–94)

□ (L/M 33)<sup>5</sup>/C–D 1; S–XVI

▼ 118,16–116,54

d – 3,44 m

Bunar

Zapuna SJ 802 sastojala se od crne rahle zemlje s mrvicama lijepa i ugljena. Zapuna bunara SJ 802 bila je ujednačena, tamnosiva do crna zemlja s dosta ugljena i različitih nalaza. Pri vrhu bila je glinasta, a pri dnu pjeskovita. U prvih 15 cm nema puno nalaza, a najveća je koncentracija pronađena na 30 cm relativne dubine. Na relativnoj dubini od 1,60 m izvirale su podzemne vode radi čega nije bilo moguće istražiti objekt do kraja.

Pored ovog, pronađena su još dva bunara (SJ 502/503 i SJ 544/545) (sl. 4), ali samo SJ 802/803 možemo povezati s rimskim selom. Druga dva bunara, pronađena su na najnižem dijelu lokaliteta. Dok u jednom nije bilo nikakvih nalaza, u drugome je pronađena novovjekovna posuda.

Pronađena je velika količina lokalno proizvedene keramike (VKJ 2), sivo pečene panonske keramike različitih struktura (VKJ 4, 7, 8, 11) i nekoliko ulomaka stolne keramike druge proizvodnje (VKJ 10, 13) i sigilate (T. 17: 8).

Od VKJ 2 strukture izdvajaju se lonci L4 (T. 16: 6–7), zdjela Z2 (T. 16: 8), posude (amfore?) lokalne proizvodnje (T. 16: 9–11). Dio keramike nepravilne je izrade, bez kola (T. 17: 1). Pronađeni su i ulomci zeleno glaziranih tarionika (T. 17: 3). Od stolne keramike izdvajaju se ulomci imitacija pompejanskih tanjura (T. 17: 5–6), zdjela koje imitiraju sigilatu Drag. 37 (T. 17: 4) i sigilata Drag. 32 rajncabernške proizvodnje (T. 17: 8). U zapuni se nalaze ulomci keramike latenskih tradicija: drške vrčeva (T. 17: 13–15) i ulomci koji mogu pripadati loncima i vrčevima (T. 17: 9–12, 16–17). Pronađeno je nekoliko nepravilnih kamenih ulomaka

### SU 732/733 (fig. 6, 91)

□ C 1/2; A–XIV

▼ 118.11–117.05

d – 1.54 m

Pit

Gray earth backfill with fragments of daub and crumbs of coal, pottery and animal bones.

Most of the pottery finds belong to locally produced dishes of VKJ 2 fabric, and a smaller share of dishes is made of VKJ 24 fabric. Several fragments of undefined forms of dishes are made of VKJ 13 fabric. A fragment of a cup with pleats was also found (Pl. 16: 5). Bones of a sheep or a goat were discovered in the pit as well (see chapter 5.1, Table 5, 6).

### SU 754/755 (fig. 6)

□ B 2; A–XIV

▼ 118.220–117.91

Dimensions: 3.08 x 0.78 m

Ashen backfill of irregular shape with dark gray earth and crumbs of coal. At the bottom, postholes SU 1487/1488, 1489/1490, 1494/1495 were found.

There was pottery and daub in the backfill. A base of a vessel made of VKJ 2 fabric and profiled handle of an amphora of VKJ 13 fabric were also found.

### SU 802/803 (fig. 6, 92–94)

□ (L/M 33)<sup>5</sup>/C–D 1; A–XVI

▼ 118.16–116.54

d – 3.44 m

Well

Backfill SU 802 consisted of black loose earth with crumbs of daub and coal. Backfill of well SU 802 was uni-

5 Početkom lipnja 2005., utvrđeno je kako lokalitet ne završava u Sektoru XIV zbog čega je teren proširen u smjeru juga i istražen do sektora XIX. Zbog toga se na postojeću mrežu dodala nova koordinatna mreža sa zaokruženim brojevima i slovima.

5 In early June 2005, it was established that the site does not end in Area XIV, which is why it was expanded to the south and researched to area XIX. Therefore, a new grid with circled numbers and letters was added to the existing network.



Sl. 94 SJ 802/803 tijekom iskopa  
Fig. 94 SU 802/803 In the course of excavations



Sl. 95 SJ 844/845, pogled sa zapada  
Fig. 95 SU 844/845, view from the west

i nešto željezne troske. Pronađen je i ulomak žrvnja sa žlijebovima (vidi poglavlje 4.6), (T. 17: 20) te ulomci dviju narukvica (T. 17: 18–19), (vidi poglavlje 4.2. kat br 5–6).

Otkriveni su ostaci prosa i poljske koljenice (vidi poglavlje, 5.2, tablica 8 / III dio) te životinjski ostaci (vidi poglavlje 5.1, tablica 5, 6).

<sup>14</sup>C datum ugljena (tablica 1) pokazuje kako bio u upotrebi krajem 2. i početkom 3. st. dok nalaz kasnoantičkih narukvica i maslinasto glaziranih tarionika dataciju učvršćuje u početak 3. st.

#### **SJ 844/845** (sl. 6, 95)

□ (N 32/33); S–XIV/XV

▼ 118,16–118,06

Dimenzije: 3,87 x 2,74 m

*Ostatak stambenog objekta?*

Zapuna nepravilnog oblika, svijetlosiva, tvrda i nabita zemlja s mrvicama lijepa, ugljenom i keramikom. Ukop je ovalnog oblika. Zdravica se pojavljuje na relativnoj dubini od 4 do 5 cm.

Pronađena je crveno slikana keramika, ulomci ručaka i tarionika, keramika lokalne VKJ 2 proizvodnje: poklopac (T. 18: 1), tarionik Tr2 (T. 18: 3a–3b) VKJ 16 strukture sa zelesnomaslinastom glazurom, ulomak crveno slikane (T. 18: 4) posude (vjerojatno tanjur). Pronađena je ručka većeg vrča ili amfore (ravnog dna?). Ručka (T. 18: 2) i ulomak tanjura su izrađeni od VKJ 13 strukture.

Nalaz glazirane keramike datira ovaj objekt u 3.–4. stoljeće. U blizini objekta nalazi se više stupova koje nije moguće jasno iščitati i povezati ih s ovom cjelinom ili ih jasno odvojiti od nje. Ova je cjelina mogla činiti dio nadzemnog objekta čiji tlocrt nije moguće odrediti.

#### **SJ 874/875** (sl. 7)

□ (M 33); S–XIV/XV

▼ 118,20–117,83 m

d – 0,59 m

form, dark gray to black earth with plenty of coal and other different findings. The earth was clayish at the top and sandy at the bottom. In the first 15 cm there were not many findings, and the highest concentration was found at the relative depth of 30 cm. At the relative depth of 1.60 m there was a spring of subterranean waters which is why it was not possible to investigate this structure to the very bottom.

In addition to this, two more wells were found (SU 502/503 and SU 544/545) (fig. 4), but only SU 802/803 can be linked to the Roman village. The other two wells were found at the lowest part of the site. While in the first one there were no findings, in the second one a Modern Age vessel was found.

In SU 802/803 substantial amount of locally produced ceramics (VKJ 2), gray fired Pannonian ceramics of different fabrics (VKJ 4, 7, 8, 11) and several pieces of tableware of another production (VKJ 10, 13) and *sigillata* (Pl. 17: 8) were found.

Of the pottery made of VKJ 2 fabric, we can single out pots L4 (Pl. 16: 6–7), a bowl Z2 (Pl. 16: 8), locally produced vessels (amphora?) (Pl. 16: 9–11). Part of the ceramics is not wheelthrown. (Pl. 17: 1). Also found are fragments of green glazed mortars (Pl. 17: 3). Among the tableware fragments the imitations of Pompeian plates stand out (Pl. 17: 5–6), as well as bowls imitating *sigillata* Drag. 37 (Pl. 17: 4) and *sigillata* Drag. 32 of Rheinzabern production (Pl. 17: 8). In the backfill there was pottery of the La Tène tradition: jug handles (Pl. 17: 13–15) and fragments that may belong to pots and jugs (Pl. 17: 9–12, 16–17). Some irregular stone fragments and some iron slag were also found, a fragment of a whetstone with channels (see chapter 4.6) (Pl. 17: 20) and fragments of two bracelets (Pl. 17: 18–19) (see chapter 4.2. Cat. Nos. 5–6).

The remains of millet and corn spurrey (see chapter 5.2, Table 8 / part III) and animal remains (see chapter 5.1, Table 5, 6) were discovered.



### Jama

Jama kružnog oblika zapune sive boje. Nalazi se južno od bunara SJ 802/803. U njoj su pronađena 4 ulomka lonca L4, VKJ 2 strukture (T. 18: 5).

#### SJ 928/929

□ (L 32-K 32/33); S–XV

▼ 118,24–117,95 m

Dimenzije: 2,92 x 1,72 m

### Jama

Zapuna nepravilnog oblika, crne boje s garom, lijepom i keramikom.

Keramika koja je ovdje pronađena pripada antičkom razdoblju. Riječ je o ulomcima trbuha različitih posuda čiji se oblik ne može definirati. Strukture nisu pripadale do sada poznatim strukturama koje se susreću na lokalitetu, ali kvalitetne su izrade.

#### SJ 954/955

□ (J 33)/A 1; S–XV

▼ 118,26–117,95

Dimenzije: 2,30 x 1,65 m

### Jama

Zapuna kružnog, nepravilnog oblika od tamnosive zemlje s ulomcima lijepa, gara i pepela.

Pronađena je keramika nedefiniranog oblika VKJ 2 strukture lokalne proizvodnje i ulomak kamenog brusa (T. 18: 6), (vidi poglavlje 4.6, brusovi: kat. br. 1).

#### SJ 966/967 (sl. 7, 96)

□ (J/K 32/33); S–XV

▼ 118,31–118,06 m

d – 1,73 m

### Jama

Zapuna kružnog oblika od svijetlosive nabite zemlje. Uokolo se nalazi nekoliko stupova koji nisu u jasnom odnosu s jamom.

U jami nije pronađeno mnogo nalaza, ali jako su zanimljivi. Pronađena je čaša tankih stijenki izrađena u kalupu, po uzoru na staklene čaše, a datira se u prvu polovinu 2. st. (T. 18: 9). Pored toga pronađen je ulomak lonca L2 (T. 18: 7) VKJ 2 strukture i ulomci lonca ili vrča ukrašeni crvenim slikanjem (T. 18: 8). Od biljnih ostataka našli smo loše očuvano zrno žitarice (vidi poglavlje 5.2).

#### SJ 1006/1007 (sl. 7)

□ (J 31); S–XV

▼ 118,69–118,45

Dimenzije: 0,45 x 0,55 m

### Jama

Zapuna manje jame s nalazima keramike. Tu je pronađen ulomak L2 lonca (T. 18: 10) VKJ 2 strukture i ulomak posude iste strukture. Oba ulomka imaju očuvan premaz.

<sup>14</sup>C date of coal (Table 1) shows that it was in use at the end of the 2<sup>nd</sup> and in the early 3<sup>rd</sup> century, while the late Antique bracelet and olive–green glazed mortars confirm the dating to the late 3<sup>rd</sup> century.

#### SU 844/845 (sl. 6, 95)

□ (N 32/33); A–XIV/XV

▼ 118.16–118.06

Dimensions: 3.87 x 2.74 m

### Remains of residential premises?

Irregularly shaped, light gray backfill, compact earth with crumbs of daub, coal and pottery. Oval-shaped cut. Sterile soil appears at the relative depth of 4 to 5 cm.

In the backfill, red painted pottery and fragments of handles and mortars were found, as well as locally produced ceramics VKJ 2: a lid (Pl. 18: 1), a mortar Tr2 (Pl. 18: 3a–3b) of VKJ 16 fabric with olive-green glaze, a fragment of red painted (Pl. 18: 4) vessel (possibly a plate). Also found is a handle of a large jug or amphora (flat base?). A handle (Pl. 18: 2) and the fragment of a plate are made of VKJ 13 fabric.

The finding of glazed ceramics dates this structure to the 3<sup>rd</sup>–the 4<sup>th</sup> century. In the vicinity of the structure there are several postholes. No clear decision as to how they were linked together can be made. This unit could be a part of the above-ground structure whose layout cannot be determined.

#### SU 874/875, (fig. 7)

□ (M 33); A–XIV/XV

▼ 118.20–117.83 m

d – 0.59 m

### Pit

Circular pit with gray backfill, located south of the well SU 802/803. Four fragments of a pot L 4 of VKJ 2 fabric (Pl. 18: 5) were found in it.

#### SU 928/929

□ (L 32–K 32/33); A–XV

▼ 118.24–117.95 m

Dimensions: 2.92 x 1.72 m

### Pit

Backfill irregularly shaped, black, with soot, daub and pottery.

Ceramics found here belong to antiquity. These are fragments of bodies of various vessels whose shape cannot be defined. Fabrics are not of the kind encountered at this site so far, but craftsmanship is of good quality.

#### SU 954/955

□ (J 33)/A 1; A–XV

▼ 118.26–117.95

Dimensions: 2.30 x 1.65 m

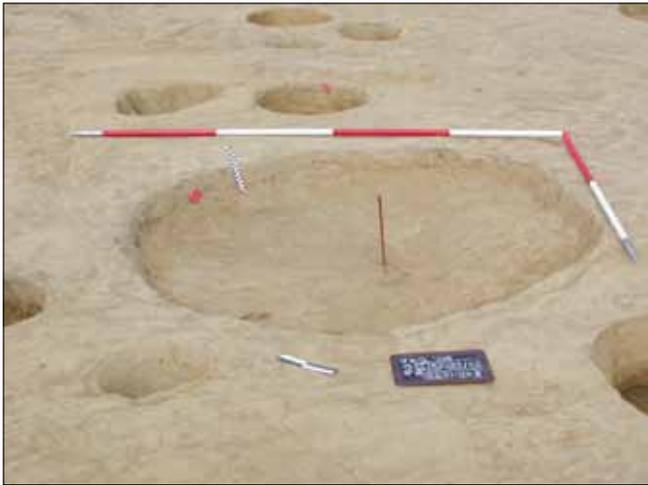

Sl. 96 Jama SJ 966/967  
Fig. 96 Pit SU 966/967

**SJ 1141/1142** (sl. 7)

□ (K 29); S–XV

▼ 118,41–117,82

Dimenzije: 0,45 x 0,55 m

*Stup*

Zapuna stupa sive boje kružnog nepravilnog oblika.

Među vrlo usitnjenim nalazima izdvaja se ulomak stakla (T. 18: 17), (vidi poglavlje 4.1, kat. br. 5).

**SJ 1229/1330** (sl. 7)

□ (J 28); S–XVI

▼ 118,41–118,31 m

$d = 0,21$  m

Zapuna stupa sive boje. Tu je pronađen ulomak panonske sivo pečene keramike s premazom i ukrasom izvedenim kotačićem (T. 18: 11). Takva se proizvodila u 1. i 2. st., ponegdje i početkom 3. st.

**SJ 1327/1328** (sl. 7, 97)

□ (L 27); S–XVI

▼ 118,22–118,05

Dimenzije: 0,64–0,85 m

*Stup*

Unutar stupa zapune tamnosive boje s dosta gara, pronađen je dio pougljenjenog drvenog stupa na visini od 10 cm. Na žalost, očuvani stup u sebi je imao previše vode te nije bio pogodan za daljnje dendrokronološke analize. Pronađeno je i nekoliko ulomaka keramike nedefiniranih oblika VKJ 2 strukture.

**SJ 1339/1340** (sl. 7, 98)

□ (K 27); S–XVI

▼ 118,33–117,36

$d = 0,68$  m

*Stup*

Zapuna kružnog oblika od tamnosive zemlje. Na dnu je pronađen ostatak drvenog stupa. Drveni ostaci bili su



Sl. 97 SJ 1328 ukop stupa s karboniziranim ostacima  
Fig. 97 SU 1328 posthole cut with carbonized remains

*Pit*

Dark earth backfill of circular, irregular shape, with fragments of daub, soot and ash.

Ceramics of locally produced undefined shape of VKJ 2 fabric and a fragment of whetstone (Pl. 18: 6), (see chapter 4.6, whetstones: Cat. No. 1) were found here.

**SU 966/967** (fig. 7, 96)

□ (J/K 32/33); A–XV

▼ 118,31–118,06 m

$d = 1,73$  m

*Pit*

Circular backfill of light gray compact earth. Several postholes which are not distinctly related to the pit were observed in the close proximity.

There were not many findings in the pit but they are very interesting. A cup with thin walls made in a mould was found; it was designed as a glass cup, and it dates back to the first half of the 2<sup>nd</sup> century (Pl. 18: 9). In addition, a fragment of a pot L2 (Pl. 18: 7) of VKJ 2 fabric was found and fragments of a pot or a jug decorated with red painting (Pl. 18: 8). When it comes to plant residues, a poorly preserved cereal grain was found (see chapter 5.2).

**SU 1006/1007** (fig. 7)

□ (J 31); A–XV

▼ 118,69–118,45

Dimensions: 0,45 x 0,55 m

*Pit*

Backfill of a smaller pit with pottery. A fragment of pot L2 (Pl. 18: 10) of VKJ 2 fabric and a fragment of a vessel made of same fabric were found here. Slip on both fragments is preserved.

**SU 1141/1142** (fig. 7)

□ (K 29); A–XV

▼ 118,41–117,82

Dimensions: 0,45 x 0,55 m

*Posthole*

Gray backfill of a posthole, of circular, irregular shape.



ispunjeni vodom te stoga jako oštećeni, pa dendrološka analiza nije bila moguća. U zapuni je pronađeno dosta ugljena, ulomci dviju posudica za lijevanje metala (T. 18: 12–13), (vidi poglavlje 4.5), dosta troske te željezni ključ (T. 18: 14), (vidi poglavlje 4.3, kat. br. 17).

#### SJ 1341/1342 (sl. 7)

□ (K 27); S–XVI

▼ 118,24–117,63

*d* – 1,42 m

*Jama*

Zapuna kružnog oblika od tamnosive pepeljaste zemlje s dosta nalaza keramike, mrvica gara i lijepa. Pronađena je keramika pretežno lokalne VKJ 2 proizvodnje od čega se izdvajaju lonac L1 i zdjela Z4 (T. 18: 15–16). Pored toga pronađeno je još ulomaka posuda VKJ 9 strukture te tri ulomka sivo pečene keramike VKJ 8 strukture.

#### SJ 1363/1364 (sl. 8, 99–103)

□ (J 24/25); S–XVII

▼ 118,37–117,89

*d* – 3,10 m

*Radni prostor, spremište*

Zapuna je rahla, pjeskovita, tamnosive boje. Kružnog je oblika s puno ulomaka lijepa, keramike, metalnih nalaza i gara. Na dnu zapune uočeni su stupovi SJ 1538/1539, 1540/1541, 1542/1543, 1544/1545.

Većina keramike pripada lokalno proizvedenoj strukturi VKJ 2 od koje su očuvani različiti ulomci nedefiniranih posuda. Od tipova izrađenih ovom strukturom prepoznaju se lonac L2 (T. 19: 1) i L5 (T. 19: 2). Pronađeni su ulomci dna i bočnih stijenki lonca izrađenih od strukture VKJ 22 (T. 19: 3), ulomci glaziranih zdjela: obodi i dna (T. 19: 4a–4b, 5), zeleno glaziranih tarionika (T. 19: 6), dno crveno slikane po-

Among very fragmented findings, a fragment of glass stands out (Pl. 18: 17), (see chapter 4.1, Cat. No. 5).

#### SU 1229/1330 (fig. 7)

□ (J 28); A–XVI

▼ 118.41–118.31 m

*d* – 0.21 m

Gray backfill of a posthole. A fragment of Pannonian gray pottery with slip and rouletting decoration was found here (Pl. 18: 11). Such ceramics had been produced during the 1<sup>st</sup> and the 2<sup>nd</sup> century, and in some places even in the early 3<sup>rd</sup> century.

#### SU 1327/1328 (fig. 7, 97)

□ (L 27); A–XVI

▼ 118.22–118.05

Dimensions: 0.64–0.85 m

*Posthole*

Inside this dark gray posthole backfill with a lot of soot, a charred piece of a wooden posthole was found at a height of 10 cm. Unfortunately, the preserved posthole contained too much water and was not suitable for further dendrochronological analysis. Several fragments of pottery of undefined shape made of VKJ 2 fabric were found as well.

#### SU 1339/1340 (fig. 7, 98)

□ (K 27); A–XVI

▼ 118.33–117.36

*d* – 0.68 cm

*Posthole*

Circular dark gray earth backfill. Remains of a wooden posthole found at the bottom. The wood remains were filled with water and therefore severely damaged, so the dendrologic analysis was not possible. Plenty of coal was found in the backfill, together with fragments of two vessels for metal casting (Pl. 18: 12–13) (see chapter 4.5), a lot of slag and an iron key (Pl. 18: 14) (see chapter 4.3, Cat. No. 17).

#### SU 1341/1342 (fig. 7)

□ (K 27); A–XVI

▼ 118.24–117.63

*d* – 1.42 m

*Pit*

Dark gray ashen earth backfill of circular shape, with plenty of pottery, crumbs of soot and daub. Predominantly locally produced VKJ 2 ceramics were found, among which a pot L1 and a bowl Z4 (Pl. 18: 15–16) stand out. In addition, fragments of vessels of VKJ 9 fabric and three fragments of gray fired ceramics of VKJ 8 fabric were discovered.



Sl. 98 SJ 1339/1340 tijekom istraživanja  
Fig. 98 SU 1339/1340 during the excavations





sude, vjerojatno tanjura (T. 19: 7). Od keramičkih predmeta pronađena su dva utega za tkalački stan (T. 19: 8–9), (vidi poglavlje 3.6), od brončanih predmeta pronađeni su ulomak fibule i zvono za stoku (T. 19: 10–11). Pronađen je željezni nož (T. 19: 12), čavli (T. 19: 13–14), motika (T. 19: 15) i budak (T. 19: 16), (vidi poglavlje 4.3, kat. br. 18–23).

Pronađeni su ostaci žitarica (vidi poglavlje 5.2, tablica 8 / IV dio) i ostaci sitnije životinje (vidi poglavlje 5.1, tablica 5).

Ova cjelina jedini je objekt kružnog oblika ove veličine. <sup>14</sup>C analizom ugljena objekt je datiran u prvu polovicu 5. st. (tablica 1). Keramički nalazi grubo datiraju cjelinu nakon sredine 4. st. Među njima nema ničeg netipičnog što odskače od nalaza iz ranijih objekata, tj. keramika lokalne proizvodnje ima iste strukturalne i tipološke odlike kao i keramika koja je prisutna na lokalitetu od 2. st., također nisu uočeni nikakvi novi elementi u arheološkoj pokretnoj građi u ovom objektu.

Nalazi upućuju na zaključak kako ovaj objekt nije služio za stanovanje nego da je imao obilježja radno-spremišnog prostora. S obzirom na nalaz utega, moguće kako se ovdje nalazio tkalački stan i spremište za alat i pohranu namirnica.

#### SJ 1355/1356 (sl. 8)

□ (K 24); S–XVII  
▼ 118,07–117,85  
d – 0,22 m

Stup

Zapuna stupa sive boje, kružnog oblika u kojemu je pronađen novac Maximijana I (vidi poglavlje 4.4, kat. br. 3), (T. 19: 17).

#### SJ 1405/1406 (sl. 8)

□ (I 25); S–XVII  
▼ 118,16–117,42  
d – 0,37 m  
Stup



Sl. 99 Objekt prije pražnjenja stupova na dnu  
Fig. 99 Structure before the emptying of postholes at the bottom of the backfill

#### SU 1363/1364 (fig. 8, 99–103)

□ (J 24/25); A–XVII  
▼ 118.37–117.89

d – 3.10 m

Working premises, storage room

Loose, sandy, dark gray backfill. Round, with lots of fragments of daub, pottery, metal findings and soot. At the bottom of the backfill, postholes have been discovered SU 1538/1539, 1540/1541, 1542/1543, 1544/1545.

Most of the pottery is made of locally produced fabric VKJ 2 of which various fragments of undefined vessels are preserved. Of the types made of this fabric, pots L2 (Pl. 19: 1) and L5 (Pl. 19: 2) can be distinguished. Also found are fragments of a base and of side walls of the pot made of VKJ 22 fabric (Pl. 19: 3), fragments of glazed bowls: rims and bases (Pl. 19: 4a–4b, 5), green glazed mortar (Pl. 19: 6) and a base of the red painted vessel, probably a plate (Pl. 19: 7). Other ceramic items which were found include two weights for looms (Pl. 19: 8–9) (see chapter 3.6) while the bronze items include a fragment of a fibula and a bell for cattle (Pl. 19: 10–11). An iron knife (Pl. 19: 12), nails (Pl. 19: 13–14), a mattock (Pl. 19: 15) and a pick (Pl. 19: 16) are among the findings as well (see chapter 4.3, Cat. Nos. 18–23).

Remains of cereals (see chapter 5.2, Table 8 / part IV) and remains of smaller animals (see chapter 5.1, table 5) were discovered.

This unit is the only circular-shaped structure of this size. <sup>14</sup>C analysis of coal dated this structure to the first half of the 5<sup>th</sup> century (Table 1). Ceramic findings roughly date the unit to the period after the mid-4<sup>th</sup> century. There is nothing atypical among the findings that would differ from the findings found in earlier structures, i.e. locally produced pottery has the same fabric and typological features as the ceramics present at the site since the 2<sup>nd</sup> century. Likewise, there were no new elements observed among the movable archaeological materials at this site.



Sl. 100 Objekt nakon pražnjenja starijih stupova na dnu ukopa  
Fig. 100 Structure after the emptying of older postholes at the bottom of the backfill



Sl. 101 Pogled iz zraka na srednjovjekovni objekt (lijevo) i objekt iz 5. st. (desno)

Fig. 101 Aerial view of the medieval structure (left) and the 5<sup>th</sup> century structure (right)

Zapuna stupa sive boje. U zapuni nije bilo nalaza osim ulomka oboda lonca (T. 20: 1)

**SJ 1431/1432**, (sl. 8)

□ (I 25); S–XVII

▼ 118,44–118,29

*d* – 0,63 m

*Stup*

Zapuna stupa sive boje. Pronađeno je nešto keramičkih nalaza, ulomci tanjura T2, VKJ 23 (T. 20: 2), ulomci keramičke struktura VKJ 2 i 11.

**SJ 1495/1496**

□ (K 24); S–XVII

▼ 117,95–117,57

Dimenzije: 0,43 x 0,33 m

*Stup*

Zapuna stupa sive boje. U njemu je pronađeno više ulomaka keramike različite strukture: VKJ 2, 7, 9, 13 i 15. Od tipova prepoznatljiv je samo lonac L3 (T. 20: 3).

**SJ 1497/1498**

□ (K 24); S–XVII

▼ 117,95–117,57

Dimenzije: 2,61 x 2,19 m

*Objekt nejasne namjene?*

Zapuna nepravilnog oblika od sive glinaste zemlje. U njoj je pronađen novac Konstancija II (vidi poglavlje 4.4, kat. br. 4), (T. 20: 4).

**SJ 1507/1508**, (sl. 8, 104)

□ (J 23); S–XVII

▼ 118,16–117,96

3,06 x 1,78 m

*Objekt nejasne namjene*

Zapuna ovalnog oblika sive pepeljaste zemlje s ke-



Sl. 102 Nalaz motike *in situ* (T. 19: 15)

Fig. 102 Finding of the mattock *in situ* (Pl. 19: 15)

The findings indicate that this structure was not used as a housing facility but that it had the characteristics of the working-storage space. Since the weights were found here, it is possible that a loom was here, as well as a tool shed and food storage.

**SU 1355/1356**, (fig. 8)

□ (K 24); A–XVII

▼ 118.07–117.85

*d* – 0.22 m

*Posthole*

Rounded gray posthole backfill in which the money of Maximianus I was found (see chapter 4.4, Cat. No. 3), (Pl. 19: 17).

**SU 1405/1406**, (fig. 8)

□ (I 25); A–XVII

▼ 118.16–117.42

*d* – 0.37 m

*Posthole*

Gray posthole backfill. There were no findings except for the rim of a pot (Pl. 20: 1).

**SU 1431/1432**, (fig. 8)

□ (I 25); A–XVII

▼ 118.44–118.29

*d* – 0.63 m

*Posthole*

Gray posthole backfill. Some ceramic findings, fragments of plates T2 of VKJ 23 fabric (Pl. 20: 2) and fragments of ceramics of VKJ 2 and 11 fabric.

**SU 1495/1496**

□ (K 24); A–XVII

▼ 117.95–117.57

Dimensions: 0.43 x 0.33 m

*Posthole*

Gray posthole backfill. Several fragments of ceramics of



Sl. 103 Nalaz budaka *in situ* (T. 19: 16)  
Fig. 103 Finding of the pick *in situ* (Pl. 19: 16)



Sl. 104 Ukop SJ 1507/1508 nakon pražnjenja  
Fig. 104 Cut SU 1507/1508 after the emptying

ramikom, mrvicama gara i lijepom. Oko ove plitke zapune pronađeno je nekoliko manjih ukopa (stupova) te je moguće da čine jednu cjelinu: SJ 1505/1506, 1624/1625, 1626/1627, 1628/1629, 1660/1661.

Pronađeno je najviše ulomaka lokalno proizvedene keramike VKJ 2 i 19 proizvodnje (T. 20: 5). Pronađena je manja količina stolnog posuđa, a izdvajaju se zdjela od tere sigilate (T. 20: 6), pompejanski tanjur VKJ 23 strukture (T. 20: 7a–7b) i lonac sivo pečene boje VKJ 4 (T. 20: 8). Moguće je da je riječ o ostacima stambenog objekta iz 2.–3. st.

#### SJ 1576/1577 (sl. 8)

□ (H/I 22); S–XVII

▼ 118,50–118,23

Dimenzije: 5,98 x 4,64 m

*Ostatak poluukopanog objekta?*

Pjeskovita zapuna nepravilnog oblika od tamnosive zemlje. U zapuni su pronađeni keramika, lijep, mrvice ugljena. Pronađeno je svega nekoliko keramičkih ulomaka, obod lonca VKJ 26 strukture, L1 (T. 20: 9) i nekoliko ulomaka većeg lonca VKJ 2 strukture.

#### SJ 1770/1771 (sl. 9, 105)

□ (E/F 17)–(G 17/18); S–XIX

▼ 118,33–118,17 m

Dimenzije: 9,03 x 1,83/3,16 m

*Objekt nejasne namjene*

Zapuna od sipke, pjeskovite, tamnosive zemlje s garom, lijepom, staklom i keramikom, nepravilnog oblika. Prema zapadu pruža se kao kanal, a prema istoku se širi i ima kružni nepravilni oblik. Uzduž zapune, prema zapadu, uz kraj ukopa nalazi se rub od žute boje širok 2 cm. Stupovi SJ 2232/2233, 2238/2239 i 2236/2237 pronađeni su na dnu tj. nakon pražnjenja zapune SJ 1770. Boja i sastav zapune stupova istovjetni su zapuni SJ 1770/1771. Moguće je da pripadaju objektu.

different fabrics were found: VKJ 2, 7, 9, 13 and 15. Only pot L3 could be recognized as a specific type (Pl. 20: 3).

#### SU 1497/1498

□ (K 24), A–XVII

▼ 117,95–117,57

Dimensions: 2.61 x 2.19 m

*Structure of undetermined purpose?*

Irregularly shaped backfill of gray clayish earth. A coin of *Constantius II* was found in the backfill (see chapter 4.4, Cat. No. 4), (Pl. 20: 4).

#### SU 1507/1508 (fig. 8, 104)

□ (J 23); A–XVII

▼ 118.16–117.96

Dimensions: 3.06 x 1.78 m

*Structure of undetermined purpose*

Oval backfill of ashen gray earth with pottery, crumbs of soot and daub. Around this shallow backfill several small cuts (postholes) were found and it is possible that they form a unit: SU 1505/1506, 1624/1625, 1626/1627, 1628/1629, 1660/1661.

Most of the fragments found are those of locally produced ceramics of VKJ 2 and 19 structures (Pl. 20: 5). Small amount of tableware was found, and a bowl of *terra sigillata* (Pl. 20: 6) stands out together with a Pompeian plate of VKJ 23 fabric (Pl. 20: 7a–7b) and a gray fired pot VKJ 4 (Pl. 20: 8). It is possible that these are the remains of a residential structure from the 2<sup>nd</sup> to the 3<sup>rd</sup> century.

#### SU 1576/1577 (fig. 8)

□ (H/I 22); A–XVII

▼ 118.50–118.23

Dimensions: 5.98 x 4.64 m

*Remains of a pit house?*

Irregularly shaped sandy backfill of dark gray earth. Ceramics, daub and crumbs of coal were found in the backfill.



Od keramičkih nalaza izdvaja se veći ulomak tarionika čija je unutrašnjost prekrivena zelenomaslinastom glazurom (VKJ 16 struktura) što ovu cjelinu datira u 3.–4. st.

Nalaz tarionika datira ovu cjelinu u kasnu antiku, ali se postavlja pitanje porijekla i svrhe ovog objekta. Smješten je na padini, plitak je, a teren je pjeskovit. Pored ukopa se nalazi veća količina stupova, ali i drugih objekata te je teško s potpunom sigurnošću tvrditi kome su ti stupovi pripadali budući da su zapune svih stupova u sastavu, boji i konzistenciji iste.

#### **SJ 1774/1775** (sl. 9, 106)

□ (F 16), S–XIX

▼ 118,83–118,30

Dimenzije: 5,33 x 1,75/3,08 m

*Objekt nejasne namjene*

Zapuna nepravilnog oblika, tamnosive boje, od tvrde nabite zemlje s lijepom i keramikom. Na dnu su pronađeni stupovi SJ 2240/2241, 1127/1128, 2234/2235, 2197/2198, 2199/2200 i 2209/2210.

Pronađena je veća količina keramike, uglavnom lokalne (VKJ 2) proizvodnje: lonci L1 (T. 20: 11–12), L2 (T. 20: 13), poklopac P1 (T. 20: 14). Zdjela Z2 (T. 20: 15) izrađena je od VKJ 23 strukture. Pored toga pronađena su dva ulomka crveno pečene keramike (VKJ 9, 13), lijep, šljunak i sitni ulomci kamena (vjerojatno ulomci žrnja).

#### **SJ 1776/1777** (sl. 9, 107)

□ (F15/16); S–XIX

▼ 118,76–118,52

Dimenzije: 12,06 x 1,13/4,94 m

*Objekt nejasne namjene*

Zapuna crne boje, sipka i pjeskovita, nepravilnog oblika. Na zapadnoj strani ima izgled kanala koji se prema sjeveroistočnoj strani nepravilno širi, slično kao SJ 1770/1771. Na dnu zapune SJ 1777 uočeni su stupovi 2303/2304, 2301/2302.

Only few ceramic fragments were discovered; rim of the pot of VKJ 26 fabric, L1 (Pl. 20: 9) and a few fragments of a larger pot of VKJ 2 fabric.

#### **SU 1770/1771** (fig. 9, 105)

□ (E/F 17)–(G 17/18), A XIX

▼ 118.33–118.17 m

Dimensions: 9.03 x 1.83/3.16 m

*Structure of undetermined purpose*

Irregularly shaped backfill of grainy, sandy, dark gray earth with soot, daub, glass and ceramics, extending westward as a channel, widening to the east in an irregular circular shape. Along the backfill, to the west, along the end of the cut, there is a yellow, 2 cm wide edge. Postholes SU 2232/2233, 2238/2239 and 2236/2237 were found at the bottom i.e. after the emptying the backfill SU 1770. The colour and the composition of the postholes backfill are identical to the backfill SU 1770/1771. It is possible that they are a part of the structure.

Among the ceramic finds, a larger fragment of mortar, with its interior covered with an olive-green glaze (VKJ 16 fabric) that dates this unit to the 3<sup>rd</sup>–4<sup>th</sup> century, can be singled out.

The mortar dates this unit to the Late Antiquity, though one wonders about the origin and the purpose of this structure. It is located on a slope, it is shallow, and the terrain is sandy. Next to the cut, a number of postholes and other objects can be observed, but it is difficult to ascertain to which unit these postholes belonged since the composition, the colour and the consistency of the backfill of all of the postholes is the same.

#### **SU 1774/1775** (fig. 9, 106)

□ (F 16), A XIX

▼ 118.83–118.30

Dimensions: 5.33 x 1.75/3.08 m

*Structure of undetermined purpose*



Sl. 105 Pogled sa zapada na zapunu SJ 1770  
Fig. 105 View of backfill SU 1770 from the west



Sl. 106 Pogled sa zapada nakon pražnjenja SJ 1774/1775  
Fig. 106 View of SU 1774/1775 from the west, after the emptying



U zapuni je pronađeno malo lijepa i keramika lokalne proizvodnje (VKJ 2), ulomci koji se ne mogu pobliže definirati. Pronađen je i kameni brus (T. 21: 1), (vidi poglavlje 4.6, brusovi: kat. br. 2).

**SJ 1852/1853** (sl. 108)

□ (E/F/G 14/15); S–XIX/XX

▼ 118,68–118,62

Dimenzije: 10 x 6,42 m

*Objekt nejasne namjene*

Zapuna je nepravilnog oblika, pjeskovita i sipka, sive boje, s puno lijepa, keramike i gara. Ispod je zdravica – crveni pijesak. Zapadni dio objekta nije istražen jer je izlazio iz trase.

Pronađena je veća količina usitnjene keramike lokalne proizvodnje VKJ 2, od čega se prepoznaju lonac L2 (T. 21: 2) i nekoliko ulomaka VKJ 24 strukture od koje je izrađen lonac L8 (T. 21: 3). Od VKJ 2 strukture izrađen je i ulomak posude, zdjele ili tanjura (T. 21: 4). Ulomak tarionika (T. 21: 5) izrađen je od VKJ 23 strukture i loše je očuvan. Pronađeni su ulomci drški, jedan je mogao pripadati L5 loncu (T. 21: 7), drugi je izrađen od sivo pečene keramike (VKJ 8), (T. 21: 8), a treći od crveno pečene keramike (T. 21: 9), VKJ 9 strukture.

Irregularly shaped backfill of dark gray, compact hard earth with daub and ceramics. At the bottom, postholes SU 2240/2241, 1127/1128, 2234/2235, 2197/2198, 2199/2200 and 2209/2210 were found.

Large amounts of ceramic, mostly locally produced (VKJ 2) were discovered: pots L1 (Pl. 20: 11–12), L2 (Pl. 20: 13), a lid P1 (Pl. 20: 14). The bowl Z2 (Pl. 20: 15) was made of VKJ 23 fabric. In addition, two fragments of red fired ceramics (VKJ 9, 13), daub, gravel and small stone fragments (probably fragments of a whetstone) were found.

**SU 1776/1777** (fig. 9, 107)

□ (F15/16); A–XIX

▼ 118.76–118.52

Dimensions: 12.06 x 1.13/4.94 m

*Structure of undetermined purpose*

Black, loose and sandy backfill of irregular shape. On the west side it has the appearance of a channel which widens irregularly to the northeast, similar to SU 1770/1771. At the bottom of the backfill SU 1777 postholes 2303/2304, 2301/2302 were observed.

Some daub and locally produced ceramics (VKJ 2) were found in the backfill; fragments which cannot be defined with precision. Also found is a grindstone (Pl. 21: 1), (see chapter 4.6, grindstones: Cat. No. 2).

**SU 1852/1853** (fig. 108)

□ (E/F/G 14/15); A–XIX/XX

▼ 118.68–118.62

Dimensions: 10 x 6.42 m

*Structure of undetermined purpose*

Backfill is irregular in shape, sandy, loose and gray, with lots of daub, ceramics and soot. There is sterile–soil – red sand underneath. The west part of the structure was not explored because it is located off route.

A larger amount of fragmented locally produced ceramics VKJ 2 was found, of which we can recognize pot L2 (Pl. 21: 2) and few fragments of VKJ 24 fabric of which pot



Sl. 107 Pogled na SJ 1776/1777  
Fig. 107 View of SU 1776/1777



Sl. 108 Pogled na SJ 1852/1853  
Fig. 108 View of SU 1852/1853



Od metalnih nalaza nađeno je zrno od bakrene slitine (T. 21: 10) i željezni grumen koji možda predstavlja trag kovačke/metalurške djelatnosti (T. 21: 11).

Nije sigurno koja je uloga ove cjeline. <sup>14</sup>C analiza ugljena pronađenog u ovoj cjelini datira iz 3.–4. st. Za većinu stupova koja je pronađena na zapadnom dijelu cjeline čini se da pripadaju nekom manjem objektu, vjerojatno ranijeg postanka od SJ 1852/1853. Interpretaciju otežava činjenica što su sve zapune iste boje, a redovito su bez nalaza i u njima je pronađen uglavnom pokoji ulomak lijepa i mrvica gara. Arheološki predmeti koji su pronađeni u ovim stupovima nisu kronološki osjetljivi.

Definirano je više ukopa koji su sijeku SJ 1852/1853 (mlađi su od njega): SJ 2229/2230, 2325/2326+2231, 2133/2234.

Definirani su i ukopi koje je SJ 1852/1853 presjekao (stariji od njega): SJ 1788/1789, 1850/1851.

Stupovi i jame koji se javljaju na dnu SJ 1852 su 1782/1783, 2191/2192, 2189/2190, 2246/2247, 2248/2249, 2250/2251, 2252/2253, 2254/2255, 2256/2257, 2258/2259, 2260/2261, 2262/2263, 2266/2267, 2268/2269, 2270/2271, 2272/2273, 2278/2279, 2280/2281, 2282/2283, 2287/2288, 2289/2290, 2291/2292, 2293/2294, 2297/2298, 2299/2300. Zapune stupova su sive boje, od rahle pjeskovite zemlje s mrvicama gara i vrlo malo nalaza. Nije moguće sa sigurnošću utvrditi jesu li stupovi istodobni sa SJ 1852/1853 ili su stariji.

#### **SJ 2133/2134** (sl. 10)

□ (G 14/15); S–XIX

▼ 118,48–118,32

*d* – 0,35 m

*Stup*

Zapuna sive boje stupa koji je uočen je na vrhu zapune 1852. U stupu je pronađeno ulomak dna zdjele na nozi ukrašene crveno slikanom bojom i obod tanjura T2 s crvenim premazom (T. 21: 12).

#### **SJ 2325/2326+2231** (sl. 10)

□ (F 14); S–XIX

▼ 118,88–118,73

Dimenzije: 0,49 x 0,68 m

*Stup*

Na vrhu zapune SJ 2325 nalazila se nakupina usitnjelog lijepa SJ 2231. Zapuna je sive boje, pjeskovite zemlje bez nalaza. Uočena je na vrhu SJ 1852.

#### **SJ 1788/1789**

□ (G 15); S XIX

▼ 118,41–118,41

Dimenzije: 3,81 x 2,2 m

*Objekt nejasne namjene*

Zapuna je tamnije boje od zapune 1852, tamnosive je boje s garom i lijepom. Sipka je i pjeskovita. Ovaj se ukop nalazi na sjeveroistočnoj strani SJ 1852/1853 i njime je presječen.

L8 (Pl. 21: 3) is made. A fragment of a vessel, a bowl or a plate (Pl. 21: 4) is made of VKJ 2 fabric. Fragment of a mortar (Pl. 21: 5) is made of VKJ 23 fabric and is poorly preserved. Also found were fragments of handles, one of which could have belonged to L5 pot (Pl. 21: 7), while the other is made of gray fired ceramics (VKJ 8), (Pl. 21: 8); the third one was made of red fired ceramics of VKJ 9 fabric (Pl. 21: 9).

Metal findings include copper alloy grain (Pl. 21: 10) and a lump of iron (Pl. 21: 11), thus indicating possible traces of metallurgy.

We cannot be certain about the purpose of this unit. <sup>14</sup>C analysis of the coal found in this unit dates it from the 3<sup>rd</sup> to the 4<sup>th</sup> century. It seems that most of the postholes found in the west wing of the unit belong to a smaller building, probably older than SU 1852/1853. Interpretation was made difficult by the fact that all the backfills were of the same colour, lacking in findings, with only some occasional fragment of daub and crumbs of soot. Archaeological items found in these postholes are not chronologically relevant.

Several cuts which intersect SU 1852/1853 were defined (which are younger than it): SU 2229/2230, 2325/2326+2231, 2133/2134.

Also defined are cuts which were intersected by SU 1852/1853 (which are older than it): SU 1788/1789, 1850/1851.

Postholes and pits which occur at the bottom of SU 1852 are as follows: 1782/1783, 2191/2192, 2189/2190, 2246/2247, 2248/2249, 2250/2251, 2252/2253, 2254/2255, 2256/2257, 2258/2259, 2260/2261, 2262/2263, 2266/2267, 2268/2269, 2270/2271, 2272/2273, 2278/2279, 2280/2281, 2282/2283, 2287/2288, 2289/2290, 2291/2292, 2293/2294, 2297/2298, 2299/2300. Backfills of postholes are gray and consist of loose sandy earth with crumbs of soot and scarce findings. It is not possible to determine with certainty whether the postholes are of the same age as SU 1852/1853 or older.

#### **SU 2133/2134** (fig. 10)

□ (G 14/15); A–XIX

▼ 118.48–118.32

*d* – 0.35 m

*Posthole*

Gray posthole backfill noted at the top of backfill 1852. A fragment of the base of a bowl on a foot, decorated with red painting and a rim of a plate T2 with red slip (Pl. 21: 12) were found in a posthole backfill.

#### **SU 2325/2326+2231** (fig. 10)

□ (F 14); A–XIX

▼ 118.88–118.73

Dimensions: 0.49 x 0.68 m

*Posthole*

At the top of backfill SU 2325 there was a cluster of fragmented daub SU 2231. Backfill consists of gray earth without findings. It is observed at the top of SU 1852.



Pronađeno je nekoliko ulomaka VKJ 2 keramike. Zanimljiv je nalaz vrča, koji nema analogija u strukturi na lokalitetu i koji je jedan od rijetkih vrčeva koji su pronađeni na Kiškoriiji. Dugi vrčevi izrađeni su od panonske sive keramike (T. 21: 13).

**SJ 1850/1851**

□ (E/F 14), S–XX

▼ 118,90–118,6

Dimenzije: 0,98 x 2,85 m

*Jama*

Zapuna izduljenog oblika, ukop je presječen velikim ukopom SJ 1852/1853. Zapuna je pjeskovita, rahla.

Nalazi se na jugozapadnoj strani SJ 1852/1853.

Pronađena je keramika VKJ 2 strukture: više oboda lonaca čiji se tipovi ne mogu sa sigurnošću definirati i ulomak L2 lonca (T. 21: 14). Sva keramika koja je ovdje pronađena pripada VKJ 2 strukturi s time da je ona izrazito narančasto pečena dok je u drugim slučajevima boja pečenja smeđa do siva. Pronađen je i lijep (T. 21: 15), (vidi poglavlje 3.7).

**SJ 2191/2192**

□ (F 14), S–XIX

▼ 118,96–118,64

*d* – 0,35 m*Stup*

Stup je otkriven na dnu SJ 1852/1853. U zapuni stupa je pronađena keramika VKJ 2 strukture, od čega se može definirati lonac L4 (T. 21: 16) i malo lijepa.

**SJ 2266/2267**

□ (F 14); S–XIX

▼ 118,74–118,34

Dimenzije: 0,78 x 0,62 m

*Stup*

Manja jama sa zapunom sive boje s malo gara, uočena na dnu SJ 1852/1853. U zapuni su još pronađeni ulomci lijepa i keramike VKJ 2 i 13 strukture, nedefiniranih oblika.

**SJ 1978/1979**, (sl. 11, 109–110)

□ (F/G 7/8); S–XXI

▼ 119,36–118,94

Dimenzije: 5,39 x 2,5 m

*Stambeni objekt*

Zapuna nepravilnog oblika tamnosive boje, pjeskovita i rahla. Iako je riječ o jednom od plićih ukopa, tu je pronađena velika količina keramičkog materijala. Sam ukop ima oko 14 m<sup>2</sup>. Oko njega nisu pronađeni stupovi pa ne znamo pouzdano je li riječ o plićem ukopu koji je činio dio nekog poluukopanog objekta ili kolibe s djelomično ukopanim prostorom. Od nalaza pronađeni su lijep, keramika i dio metalnog noža.

Od keramičkog posuđa najveći dio izrađen je od lokalne strukture VKJ 2: pronađeni su lonci tipa L1 (T. 22: 1–2),

**SU 1788/1789**

□ (G 15); A–XIX

▼ 118,41–118,41

Dimensions: 3.81 x 2.2 m

*Structure of undetermined purpose*

Backfill is darker than backfill 1852, it is dark gray with soot and daub. It is loose and sandy. This cut was located on the northeast side of SU 1852/1853 which intersects it.

Several fragments of VKJ 2 ceramics were found. The jug is an interesting find, its fabric has no analogy to the structure at the site, and it is one of the few jugs that were found on Kiškoriija. Long jugs are made of the Pannonian gray ceramics (Pl. 21: 13).

**SU 1850/1851**

□ (E/F 14); A–XX

▼ 118,90–118,6

Dimensions: 0.98 x 2.85 m

*Pit*

Backfill of an elongated shape; the cut was intersected by a large cut SU 1852/1853. Backfill is sandy and loose. It is located on the southwest side of SU 1852/1853.

Ceramics of VKJ 2 fabric were found: several rims of pots whose types cannot be defined with certainty and a fragment of L2 pot (Pl. 21: 14). All pottery found here is made of VKJ 2 fabric except that in this case it is distinctly orange fired while in other cases the firing colour is brown to gray. Also found is daub (Pl. 21: 15) (see chapter 3.7).

**SU 2191/2192**

□ (F 14); A–XIX

▼ 118,96–118,64

*d* – 0.35 m*Posthole*

A posthole was discovered at the bottom of SU 1852/1853. In its backfill some daub and ceramics of VKJ 2 fabric were found, among which a L4 pot can be distinguished (Pl. 21: 16).

**SU 2266/2267**

□ (F 14); A–XIX

▼ 118,74–118,34

Dimensions: 0.78 x 0.62 m

*Posthole*

A smaller pit with gray backfill with some soot observed at the bottom of SU 1852/1853. In the backfill, fragments of daub and ceramics of VKJ 2 and 12 fabrics and of undefined shapes were found as well.

**SU 1978/1979**, (fig. 11, 109–110)

□ (F/G 7/8); A–XXI

▼ 119,36–118,94

Dimensions: 5.39 x 2.5 m

*Residential premises*

Irregularly shaped dark gray backfill, sandy and loose. Although it is one of the shallower cuts, a large quantity of ceramic material was found in it. The cut itself is about 14 m<sup>2</sup> large. Postholes were not found around it, so that



L2 (T. 22: 3), L3 (T. 22: 4-5), tanjur T1 (T. 22: 6) zdjele Z1 (T. 22: 7-9), poklopci P2 (T. 23: 1) i P3 (T. 23: 2) te drške poklopaca (T. 23: 4-5). Pronađen je i ulomak posude tankih stijenki (T. 23: 6), zdjelice od strukture koja je prisutna i u SJ 966/977, a riječ je o čaši datiranoj u početak 2. st. (kat br. 116) Pronađeno je i nekoliko ulomaka sive panonske keramike (VKJ 4) i crveno pečene (VKJ 9) keramike čiji se oblici ne mogu definirati.

Pored keramike pronadjen je i fragment sječiva noža (T. 23: 7), (vidi poglavlje 4.3, kat. br. 27).

Zdjelica keramike tankih stijenki tj. njezina struktura predstavlja vrlo rijedak primjerak takve vrste keramike na lokalitetu i u Panoniji. Ukoliko nije dospjela u ovom ukopu u sekundarnom kontekstu, možda bi temeljem analogije ova cjelina mogla datirati u 2. st. Drugi nalazi nisu previše kronološki osjetljivi da bi nam pomogli pri dataciji.

#### SJ 2149/2150 (sl. 11, 111)

□ (D/E 10/11); S-XX

▼ 119,54-119,0

Dimenzije: 2,60-1,50 m

*Dio poluukopanog stambenog objekta?*

Zapuna smeđesive boje, pjeskovita, rahla s mrvicama gara i lijepa. Zapadni dio izlazi iz okvira zadane trase te nije u cijelosti istražen. Nalazi su koncentrirani u prvih 15 cm.

Pronađeni su lonci L1 (T. 23: 8; T. 24: 1-2), L2 (T. 24: 3). Pored lokalno proizvedene keramike (VKJ 2, 19, 20) ovdje je pronadeno dosta ulomaka žuto pečene posude (VKJ 18) nedefiniranog oblika koji se javlja samo u ovom objektu. Uz to, otkriveno je nekoliko ulomaka sivo pečene keramike, ulomak zdjele sa sjajnim sivim premazom (T. 24: 4a-4b) te nešto crveno pečene keramike od kojih je jedan ulomak definiran kao zdjela (T. 24: 5). Ovaj objekt datira se od 2. do 3. st. Moguće da je riječ o južnom dijelu objekta stambenog karaktera.

#### SJ 2155/2156 (sl. 10-11, 112)

□ (F 10); M S - XX

▼ 119,24-118,98 m



Sl. 109 Objekt SJ 1978/1979  
Fig. 109 Structure SU 1978/1979

we cannot know for sure whether it is a shallow cut which formed part of a pit house or a hut with a partly buried section. Daub, ceramics and a part of a metal knife were unearthed.

The largest part of ceramic dishes were made of a local fabric VKJ 2: pots of the L1 type (Pl. 22: 1-2), L2 (Pl. 22: 3), L3 (Pl. 22: 4-5), a plate T1 (Pl. 22: 6), bowls Z1 (Pl. 22: 7-9), lids P2 (Pl. 23: 1) and P3 (Pl. 23: 2) and lid handles (Pl. 23: 4-5). Also a fragment of a thin-walled vessel was found (Pl. 23: 6), bowl of fabric present in SU 966/977 – a glass dated to the beginning of the 2<sup>nd</sup> century (Cat no. 116). Several fragments of Pannonian gray pottery (VKJ 4) and red fired (VKJ 9) ceramics whose forms cannot be defined, have been found as well.

In addition to pottery, a fragment of the blade of a knife was found (Pl. 23: 7), (see chapter 4.3, Cat. No. 27).

A small thin-walled bowl, i.e. its fabric, represents a very rare example of this kind of pottery, both at this site and in Pannonia. Had it not come into this cut in the secondary context, than this unit could be, based on the analogy, dated to the 2<sup>nd</sup> century. Other findings are not enough chronologically reactive to help us with the dating.

#### SU 2149/2150 (fig. 11, 111)

□ (D/E 10/11); A-XX

▼ 119.54-119.0

Dimensions: 2.60-1.50 m

*Part of a pit house?*

Gray-brown backfill, sandy, loose, with crumbs of soot and daub. The west wing of the structure is situated beyond the scope of the given route, so it was not fully explored. Findings are concentrated in the first 15 cm.

Pots L1 (Pl. 23: 8; Pl. 24: 1-2) and L2 (Pl. 24: 3) were found. In addition to locally produced ceramics (VKJ 2, 19, 20) plenty of fragments of a yellow fired vessel (VKJ 18) of undefined shape were found only in this structure. Furthermore, a few gray fired ceramic fragments, fragment of a bowl with a shiny gray slip (Pl. 24: 4a-4b) and some red fired ceramics of which one fragment is defined as a bowl (Pl. 24: 5) were discovered. This structure dates from the 2<sup>nd</sup> to the 3<sup>rd</sup> century. It is possible that this is the southern part of a residential building.

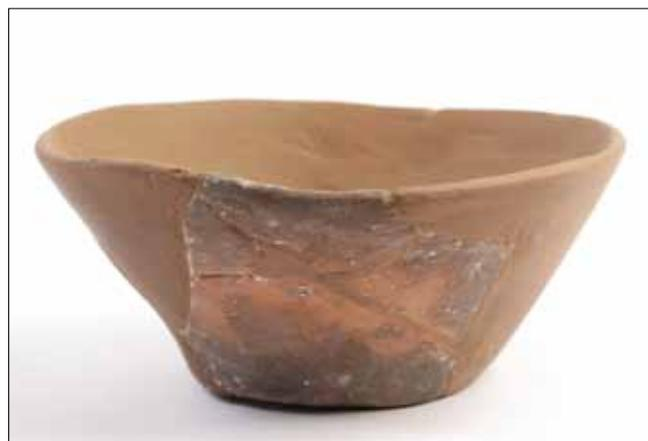

Sl. 110 Restaurirana zdjelica iz SJ 1978/1979, VKJ 2 strukture  
Fig. 110 Bowl from SU 1978/1979, of VKJ 2 fabric, after restoration





Dimenzije: 1,5 x 2,3 m

*Jama*

Zapuna pravokutnog oblika zaobljenih krajeva sa zemljom svijetlosive boje. Na dnu zapadnog dijela uočen je manji stup.

U zapuni je pronađeno nekoliko ulomaka keramike lokalne proizvodnje (VKJ 2), jedan željezni nož (T. 24: 6), (vidi poglavlje 4.3, kat. br. 28) i ostaci klipastog muhara (vidi poglavlje 5.2, tablica 8 / IV dio).

**SJ 2242/2243** (sl. 11, 113)

□ (D 9); S-XX

▼ 119,50–119,37

*d* – 0,28 m

*Stup*

Zapuna stupa od sipke, pjeskovite zemlje s mrvicama gara i lijepa. Od nalaza je pronađen dio brončane fibule PN 59 (T. 24: 7) iz 2. st. (vidi poglavlje 4.3, kat. br. 29).

### 2.3.3. Strukture za pripremu hrane i ognjišta

Na Virovitici Kiškoriji jug hrana se pripremala na struktura izrađenim od daske i lijepa ili na ognjištima. Pronađena su dvije strukture za pripremu hrane i 5 ognjišta. Struktura SJ 004/005 je opisana u okviru kompleksa 1, a struktura SJ 630/631 u okviru kompleksa 9 zajedno s ognjištem SJ 634/635.

**SJ 437/438** (sl. 4–5, 114–117)

□ R/S 23; S-VIII

▼ 117,31–117,19

*d* – 1,48 m

*Ognjište s nadstrešnicom*

SJ 427 je zapuna sive boje (u sredini), čiji su rubovi žućkasti i miješaju se sa zdravicom. U zapuni je pronađeno

**SU 2155/2156** (fig. 10–11, 112)

□ (F 10); A-XX

▼ 119,24–118,98 m

Dimensions: 1.5 x 2.3 m

*Pit*

Rectangular backfill with rounded corners, with light gray earth. A smaller posthole was observed at the bottom of the western part.

Few fragments of locally produced pottery (VKJ 2), an iron knife (Pl. 24: 6), (see chapter 4.3, Cat. No. 28) and remains of foxtail millet (see chapter 5.2, Table 8 / part IV) were found in the backfill.

**SU 2242/2243** (fig. 11, 113)

□ (D 9); A-XX

▼ 119.50–119.37

*d* – 0.28 m

*Posthole*

Backfill of a posthole consisting of loose, sandy earth with crumbs of soot and daub. The findings include a fragment of a bronze fibula SF 59 (Pl. 24: 7) dated to the 2<sup>nd</sup> century (see chapter 4.3, Cat. No. 29).

### 2.3.3. Food preparation facilities and hearths

At the Virovitica Kiškorija south site, food was prepared on structures made of planks and daub or on hearths. Two structures for food preparation and five hearths were discovered. Structure SU 004/005 is described in the context of complex 1, and structure SU 630/631 in the context of complex 9 together with the hearth SU 634/635.

**SU 437/438** (fig. 4–5, 114–117)

□ R/S 23; A-VIII

▼ 117.31–117.19

*d* – 1.48 m

*Hearth with a shed*

SU 427 is a gray (in its centre) backfill, whose edges are



Sl. 111 Ukop objekta SJ 2149/2150, pogled sa sjevera  
Fig. 111 Cut of the structure SU 2149/2150, view from the north



Sl. 112 Ukop SJ 2155/2156  
Fig. 112 Cut SU 2155/2156



dosta ugljena. Ukop se može pratiti na južnoj i istočnoj strani, a na drugim mjestima se gubi. U trenutku praznjenja ukopa činilo se da se pojavljuje struktura od lijepa, ali se kasnije vidjelo da se radi o tvrdoj i zapečenoj zemlji. Na zapečenoj zemlji i ugljenu pronađeni su veći ulomci posude (T. 24: 8, sl. 114–115). Pored ulomaka tog lonca pronađeni su i ulomci drugih posuda, uglavnom vrlo grube i nepravilne izrade, a po svojim karakteristikama (dosta tinjca i kvarca) bili su pogodni za kuhanje. Oko SJ 437/438 definirani su stupovi SJ 441/442, 445/446, 443/444, 439/440, 447/448 i 495/496. Budući da u neposrednoj blizini nema drugih cjelina, a navedeni stupovi okružuju SJ 437/438, logično je pretpostaviti da čine jedinstvenu cjelinu.

Pronađeni su ulomci velikih lonaca lokalne su proizvodnje (VKJ 2, 24, 28) i služili su za kuhanje. U zapuni se nalazilo mnogo ugljena, a najveća je koncentracija bila ispod velikog lonca (T. 24: 8). Pored lonca za kuhanje pronađen je i manji ulomak dna zdjele od sigilate koji je oštećen sekundarnim gorenjem (T. 25: 2a–2b).

Na mozaiku na lokalitetu Sainte-Colombe prikazana je krušna peć s nadstrešnicom i manjom jamom za ogrjev (Poux et al. 2013: 149, fig. 157). U slučaju SJ 437/438 nisu pronađeni elementi konstrukcije ili kalote peći. S obzirom na zapečeno dno i stupove koji se nalaze oko nje, pretpostavljam da se radi ognjištu s nadstrešnicom koja je okruživala ognjište. Nalaz keramičkih lonaca za kuhanje, pronađeni u zapuni SJ 437 također govore u prilog definiranju ove cjeline kao ognjišta, a ne krušne peći.

Sličan objekt pronađen je u Slovačkoj, ali u srednjovjekovnom kontekstu. Ondje je riječ o centralnoj jami u kojoj je ložena vatra, a oko nje su stupovi koji su tvorili nadstrešnicu (Hanuliak 1989: 185, 197, Tab. IV: 6).

Ova cjelina je datirana <sup>14</sup>C analizom u kasnu antiku (tablica 1), u drugu polovinu 3. st.

yellowish and mixed with sterile-soil. Plenty of coal was found in the backfill. The cut can be traced to the south and to the east. At the time of the emptying of the cut it seemed that the structure made of daub shows, but later it proved to be hard and baked ground. On this baked earth and coal, fragments of a larger vessel (Pl. 24: 8, fig. 114–115) were found. In addition to this, fragments of other vessels were found, mostly very coarse and shapeless, which were, according to their characteristics (plenty of mica and quartz), suitable for cooking. Around SU 437/438, the following postholes were defined: SU 441/442, 445/446, 443/444, 439/440, 447/448 and 495/496. Since there are no other units in the vicinity, and the aforementioned postholes surround SU 437/438, it is logical to assume that they constitute a single unit.

Also found are fragments of large locally produced pots (VKJ 2, 24, 28) which were used for cooking. In the backfill, a lot of coal was discovered, with the highest concentration below the large pot (Pl. 24: 8). In addition to the cooking pot, a small fragment of the base of a *sigillata* bowl was found, which was damaged by secondary firing (Pl. 25: 2a–2b).

A mosaic at the Sainte-Colombe site shows a bread oven with a shed and a small pit for the firewood (Poux et al. 2013: 149, fig. 157). In the case of SU 437/438 no elements of the structure or of the calotte of a kiln were found. Given the burnt bottom and postholes around it, we can assume that this is a hearth with a shed, which surrounded it. Finding of ceramic pots used for cooking, recovered in the backfill SU 437, also speaks in favour of defining these units as hearths, and not the bread ovens.

A similar object was found in Slovakia, but in a medieval context. There we can see a central pit in which there was a fire, and postholes around it which formed a shed (Hanuliak 1989: 185, 197, Tab. IV: 6).

This unit is dated by <sup>14</sup>C analysis to the late Antiquity (Table 1), to the second half of the 3<sup>rd</sup> century.



Sl. 113 Ukop stupa SJ 2242/2243  
Fig. 113 Posthole cut SU 2242/2243

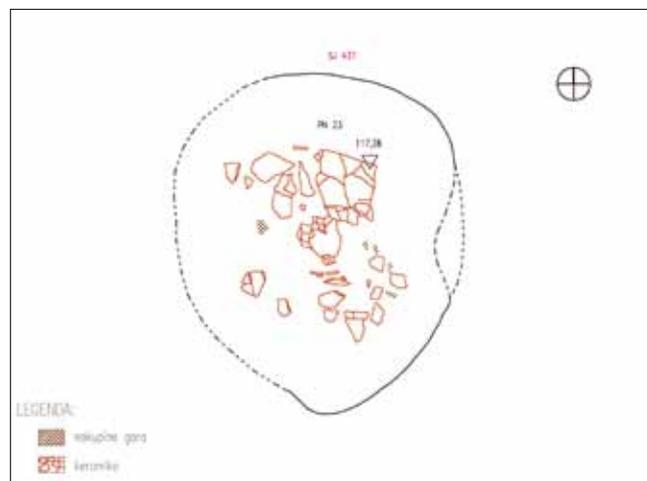

Sl. 114 Tlocrt zapune s ulomcima posude za kuhanje (T 24: 8)  
Fig. 114 Layout of the backfill with fragments of a cooking vessel (Pl. 24: 8)

Sl. 115 Nalazi lonaca za kuhanje *in situ* u zapuni s ugljenom SJ 437/438Fig. 115 Finding of cooking pots *in situ* in the backfill with coal SU 437/438**SJ 670/671** (sl. 6, 118–121)

□ C 4; S–XIV

▼ 118,02–117,97

Dimenzije: 1,27 x 1,1 m

*Ognjište?*

Zapuna pravokutnog oblika zaobljenih krajeva, tamnosive boje. U središnjem dijelu nalazi se zapečena zemlja i kompaktne nakupine lijepa. Ova cjelina podsjeća na SJ 634/635, ali je lošije očuvana i ima manje elemenata za promišljanje i rekonstrukciju. Pretpostavka je da je i tu riječ o ognjištu.

**SJ 1012/1013+1535** (sl. 7, 122–127)

□ (M/N 30); S–XV

▼ 118,43–117,94

Dimenzije: 1,20 x 1,10 m

*Ognjište*

Zapuna od crne zemlje s puno ugljena i lijepa, nepravil-

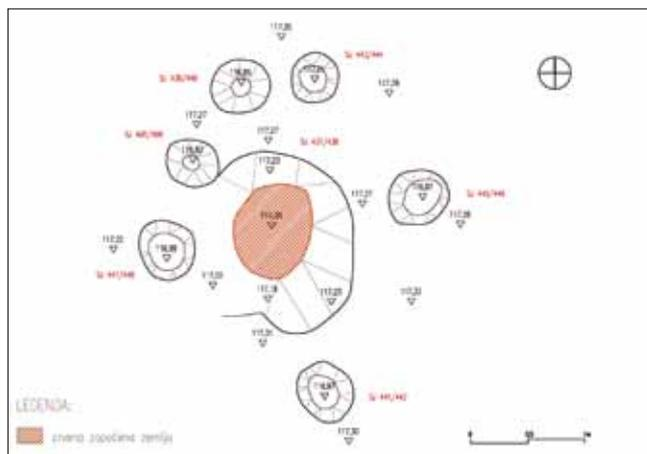

Sl. 117 Dno jame sa zapečenom zemljom ispod ugljena i posuda, SJ 437/438

Fig. 117 Bottom of the pit with baked earth under the coal and vessels, SU 437/438



Sl. 116 Dno jame sa zapečenom zemljom ispod ugljena i posuda, SJ 437/438

Fig. 116 Bottom of a pit with baked earth under the coal and the vessels, SU 437/438

**SU 670/671** (fig. 6, 118–121)

□ C 4; A–XIV

▼ 118,02–117,97

Dimensions: 1.27 x 1.1 m

*Hearth?*

Rectangular shaped backfill with rounded corners, of dark gray colour. In the central part, there is baked earth and compact clusters of daub. This unit is reminiscent of SU 634/635, but it is poorly preserved and has fewer elements for reflection and reconstruction. It is assumed to be a hearth.

**SU 1012/1013+1535** (fig. 7, 122–127)

□ (M/N 30); A–XV

▼ 118,43–117,94

Dimensions: 1.20 x 1.10 m

*Hearth*

Backfill of black earth with a lot of coal and daub, and of irregular circular shape. Below the backfill 1012, there is baked earth SU 1535. The bottom of this cut is calotted,

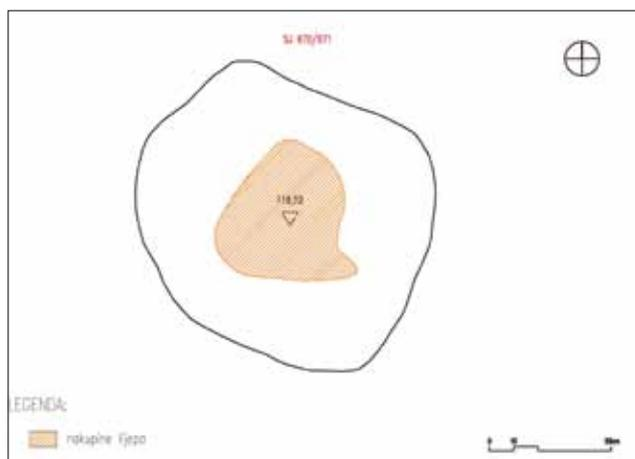

Sl. 118 Tlocrt SJ 670/671

Fig. 118 Layout of SU 670/671



Sl. 119 Zapuna SJ 670/671 nakon poliranja  
Fig. 119 Backfill of SU 670/671 after the polishing

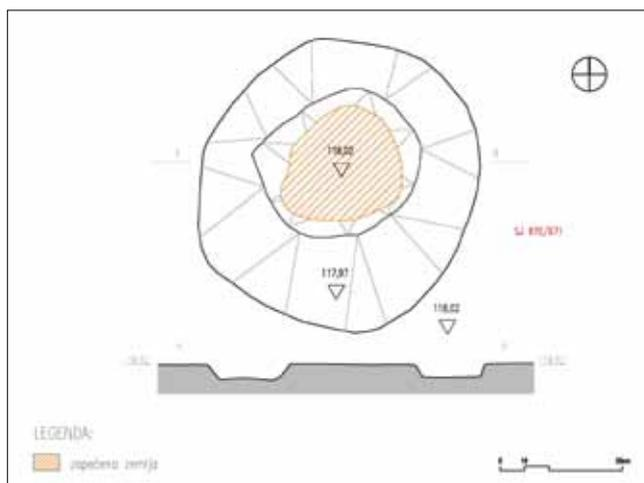

Sl. 120 Tlocrt ukopa SJ 670/671  
Fig. 120 Layout of the cut SU 670/671

nog kružnog oblika. Ispod zapune 1012, nalazi se zapečena zemlja SJ 1535. Dno ovog ukopa kalotasto je, za razliku od prethodnih cjelina gdje je bilo ravno. Dno je jako zapečeno. Pronađeni su ostaci biljaka (žitarica, ječma i prosa, vidi poglavlje 5.2, tablica 8 / IV dio) što govori u prilog činjenici kako je ova cjelina služila za pripremu hrane. Ulomci lijepa vrlo su sitni što uz oblik zapečene jame govori u prilog tome kako je ovdje također riječ o ognjištu, a ne zidanoj strukturi za pripremu hrane.

#### SJ 1333/1334 (sl. 7, 128–130)

- (K 27); S–XVI
- ▼ 118,33–118,09
- d – 0,65 m
- Ostatak ognjišta?

Zapuna od gline, gara i lijepa, tvrda, nabita i sive boje. Kružnog je oblika, a u središnjem dijelu nalazi se usitnjeni lijep pravokutno posložen. Ispod lijepa nalazila se jama. Tu su pronađeni i ostaci kostiju manje životinje (vidi poglavlje 5.1, tablica 5).



Sl. 121 Ukop SJ 670/671  
Fig. 121 Cut SU 670/671

unlike in the previous units, where it came flat. The bottom is well baked. The remains of plants (wheat, barley and millet, see chapter 5.2, Table 8 / part IV) were found, which would indicate that this unit was used for food preparation. Fragments of daub are very small which, together with the shape of the baked pit, indicates that there was a hearth in this place and not a brick structure for food preparation.

#### SU 1333/1334 (fig. 7, 128–130)

- (K 27); A–XVI
- ▼ 118.33–118.09
- d – 0.65 m
- Remains of a hearth?

Backfill of clay, soot and daub; hard, compact and gray. It is circular, and in the central part there is fragmented rectangular–arranged daub. Below the daub there was a pit. The remains of bones of a smaller animal were found here (see chapter 5.1, Table 5).



Sl. 122 Peć SJ 1012, s garom i zapečenim dnom  
Fig. 122 Hearth SU 1012, with soot and a baked bottom



SI 123 Detalj ognjišta SJ 1012  
Fig. 123 A detail of the hearth SU 1012

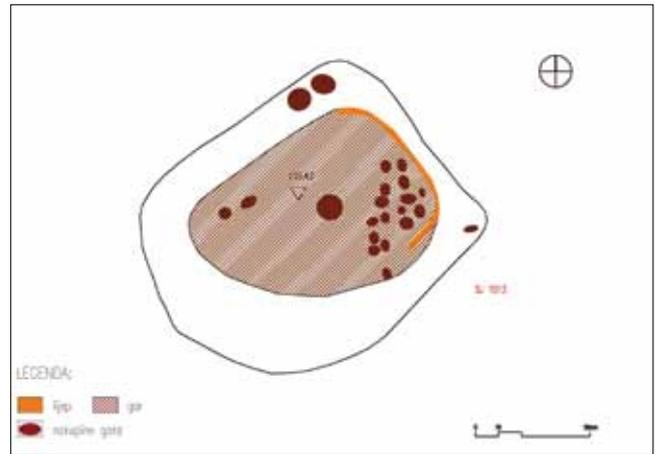

SI 124 Peć SJ 1012/1013, s garom i zapečenim dnom  
Fig. 124 Hearth SU 1012/1013, with soot and a baked bottom

### SJ 1708/1709 (sl. 9, 131–132)

□ (H/I 17); S–XIX

▼ 118,28–117,63

d – 1,02 m

*Ostatak ognjišta?*

Zapuna kružnog oblika od tamnosive, sipke zemlje s kompaktnom strukturom od nabijenog lijepa SJ 2284 u srednjem dijelu. U strukturi od lijepa je pronađen ulomak keramike VKJ 24 strukture.

U zapuni SJ 1708 je pronađeni su ulomak željeznog predmeta (T. 20: 10), (vidi poglavlje 4.3, kat. br. 24) i troska.

#### *Strukture za pripremu hrane*

Usporedbom struktura s lokaliteta Virovitica Kiškorija jug s onima korištenim u većim vilama i gradovima te analizom prikupljenih arheobotaničkih i arheozooloških ostataka sigurni smo da je riječ o strukturama koje su korištene za kuhanje rimske hrane. U samoj Kiškoriji su uočene pojedine razlike između struktura: razlikuju se po jamama pronađenima ispod ostataka strukture tj. jama ispod

### SU 1708/1709 (fig. 9, 131–132)

□ (H/I 17); A–XIX

▼ 118.28–117.63

d – 1.02 m

*Remains of a hearth?*

Circularly shaped backfill of dark gray, loose earth with a compact structure made of compacted daub SU 2284 in the middle. A fragment of pottery of VKJ 24 fabric was found in the daub structure

A fragment of an iron item (Pl. 20: 10) (see chapter 4.3, Cat. No. 24) and slag were discovered in the backfill SU 1708

#### *Food preparing structure*

After having compared the structures from Virovitica Kiškorija south site with those used in larger villas and cities, as well as after having analyzed the collected archaeobotanical and archaeozoological remains, we are confident that these structures were used for cooking of Roman food. In Kiškorija itself some differences between the structures were noticed: they differ by pits found beneath the remains of structures i.e. the pit beneath the structure



SI 125 Detalj peći SJ 1012, nakon uklanjanja gara  
Fig. 125 A detail of a hearth SU 1012, after the removal of soot



SI 126 Ukop SJ 1012/1013  
Fig. 126 Cut SU 1012/1013

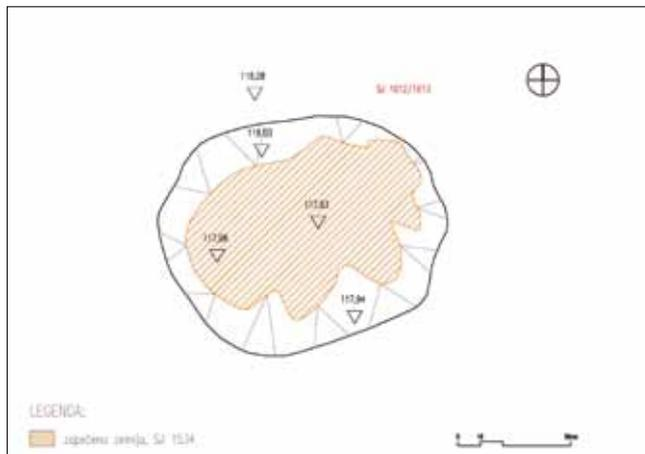

Sl. 127 Tlocrt ukopa SJ 1012/1013  
Fig. 127 Layout of the cut SU 1012/1013



Sl. 128 Pogled na SJ 1333/1334 sa strukturom od lijepa  
Fig. 128 View of SU 1333/1334 with a daub structure

strukture u kompleksu 1 (SJ 004/005) je znatno dublja od jame u kompleksu 9 (SJ 630/631). Također, ona je zapunjena s velikom količinom pepela na dnu prema čemu bi se moglo zaključiti da je u tom slučaju jama služila za privremeno odlaganje pepela za vrijeme kuhanja, kako bi se ploha za kuhanje očistila. Situacija sa SJ 630/631 je znatno drugačija, ispod ostataka strukture i plohe za kuhanje, nalazio se vrlo plitak ukop ravnog dna.

Nalazi iz Galije, a naročito Pompeja govore o postojanju različitih struktura za pripremu hrane: zidane krušne peći, ognjišta s polukružnom konstrukcijom, strukture s ravnom plohom nalik stolu na kojima se kuhalo (Desbat 2013: 36–37). Ove posljednje, imaju iste elemente kao i strukture pronađene na Virovitici Kiškoriji jug: zidane su i imaju ravnu radnu plohu na kojoj se ložilo i kuhalo. Nalazi lijepa govore o konstrukciji za koju u nekim slučajevima možemo naslutiti kako je izgledala: ostaci iz najbolje očuvane SJ 630 govore o konstrukciji pravocrtnih linija. Osnovna razlika između struktura za pripremu hrane u Kiškoriji i struktura na velikim vilama i gradovima je u dimenzijama i materijalu koji je korišten: u Kiškoriji to su bili drvo i lijep, a na vila-

re in complex 1 (SU 004/005) is much deeper than the pit in complex 9 (SU 630/631). Also, it was filled with a large amount of ash at the bottom from which we might conclude that in this case the pit was used for temporary disposal of the ashes during cooking, thus keeping the cooking surface clean. The situation with SU 630/631 is significantly different: underneath the remains of the structure and the cooking surface, there was a very shallow flat bottom cut.

Findings from Gaul, and especially those from Pompeii, indicate the existence of different structures for food preparation: brick bread ovens, hearths with a semicircular structure, structures with a flat surface resembling a table, on which food was cooked (Desbat 2013: 36–37). The latter have the same elements as structures found at Virovitica Kiškorija south: they are masonry and have a flat working surface used for making fire and cooking. Findings of daub testify of the construction for which, in some cases, we can anticipate what it looked like: remains from the best preserved SU 630 testify of the structure of straight lines. The main difference between food preparing structures in Kiškorija and structures in large villas and cities is in the dimensions and the materials used: in Kiškorija wood and daub were used, and in villas and cities brick and mortar.

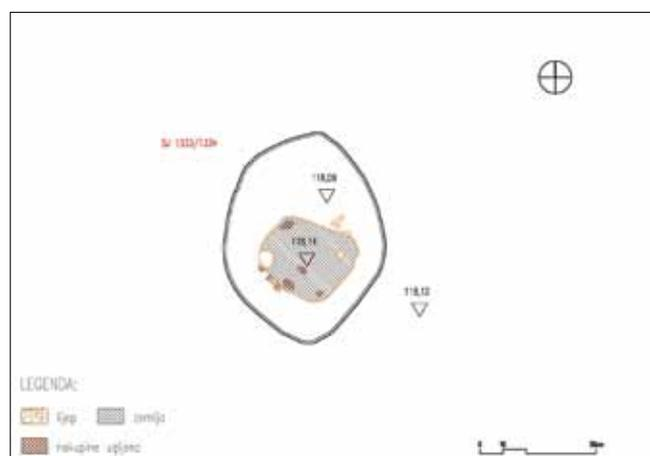

Sl. 129 Tlocrt SJ 1333/1334 s lijepom  
Fig. 129 Layout of SU 1333/1334 with daub



Sl. 130 Pogled na ukop SJ 1333/1334 nakon pražnjenja  
Fig. 130 View of the cut SU 1333/1334 after the emptying

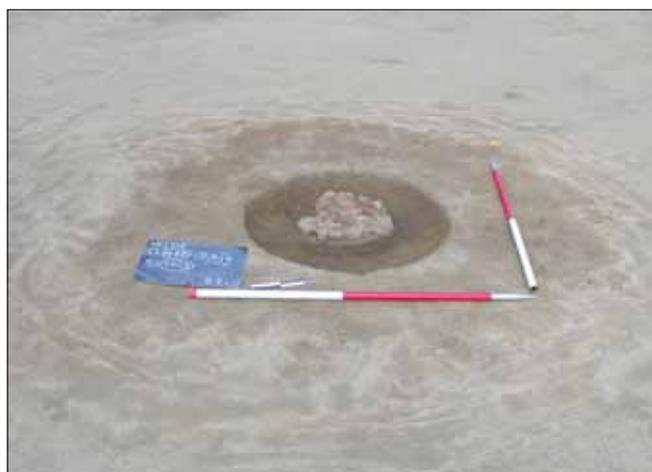

Sl. 131 Ukop SJ 1708/1709 sa strukturom SJ 2284 u središnjem dijelu

Fig. 131 Cut SU 1708/1709 with a structure SU 2284 in the middle

ma i u gradovima opeka i žbuka. Sama veličina vjerojatno govori o broju ljudi za koje se hrana na takvim strukturama pripremala. U gradovima i na vilama riječ je o većim domaćinstvima, dok je u selima očigledno riječ o manjim obiteljima.

#### Ognjišta

Cjeline definirane kao ognjišta također su dosta oštećene i ne dozvoljavaju nam sigurnu rekonstrukciju njihova izgleda. Broj analogija sličnih cjelina u rimskim selima nije od velike pomoći, jer i sami broj objavljenih sela nije velik, naročito u južnom dijelu Panonije. Među ognjištima također su uočene neke razlike: ognjišta SJ 437/438, 427/428, 670/671 plitko su očuvana i imaju ravno dno, dok ognjište SJ 1012/1013 ima zapečenu dublju jamu. Oko ognjišta SJ 437/438 nalazi se 5 stupova koji su tvorili nadstrešnicu za ognjište što nije uočeno kod drugih ognjišta.

Strukture za kuhanje s ravnom plohom u svakom su slučaju znak romanizacije prostora, dok su ognjišta mogla biti naslijeđena iz ranijeg razdoblja.

Poljoprivrednom obradom zemljišta gornji dio lokaliteta je izoran, a ove su cjeline znatno oštećene. Radi toga nije moguće sa sigurnošću utvrditi, ne samo njihov izgled, već i odnos s okolnim objektima.

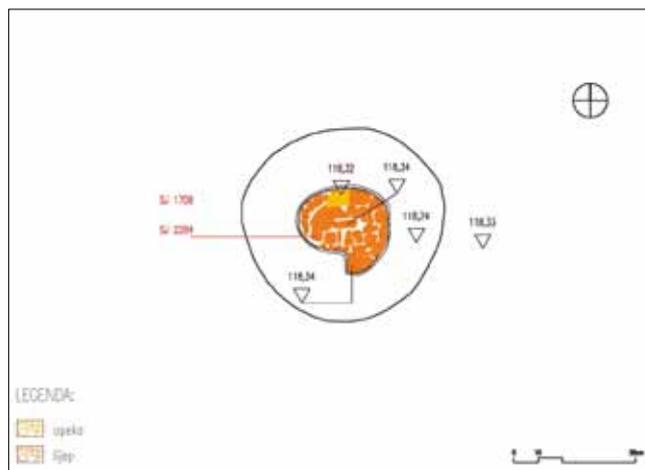

Sl. 132 Tlocrt SJ 1708/1709

Fig. 132 Layout of SU 1708/1709

The size itself probably speaks about the number of people for whom food was prepared. In cities and villas households were large, while in villages the amount of people were evidently smaller.

#### Hearths

Units defined as hearths are also quite damaged and do not allow us to reconstruct them with certainty. Analogies with similar units in Roman villages is not very helpful, because the number of published villages alone is not large, especially in the southern part of Pannonia. Among the hearths some differences were also observed: hearths SU 437/438, 427/428, 670/671 are preserved to a small depth and have a flat bottom, while hearths SU 1012/1013 have a deeper baked pit. Around the hearth SU 437/438 there are five pillars that formed a shed for the hearth, which was not the case in other hearths.

Structures for cooking with flat surface are, by all means, the manifestation of Romanization of the area, while hearths could be inherited from the previous period.

The upper part of the site was ploughed during the agricultural cultivation of the land, so that these units are considerably damaged. Therefore, it is not possible to determine with certainty, not only their appearance, but also their relationship with the surrounding structures.



### 2.3.4. Slojevi

Sloj **SJ 001** površinski je sloj humusa u kojemu je pronađena znatna količina različitog, ali dosta usitnjelog materijala. Prostirao se na cijelom lokalitetu. Neki od predmeta predstavljaju zanimljive i vrijedne nalaze koje svakako treba spomenuti i obraditi. Od keramičkih nalaza iz površinskog sloja izdvajaju se samo ulomci velikog dolija lokalne proizvodnje (T. 26: 1), ulomak staklene posude (T. 26: 2), staklenih narukvica (T. 26: 3–5), brončanog posuđa (T. 26: 6–7), dva prstena (T. 26: 8–9), jezgra (T. 26: 10) i novac (T. 26: 11).

Sloj **SJ 002** je pronađen u sjeverom dijelu lokaliteta u sektorima VI i VII uz recentni kanal. U njemu je pronađeno dosta nalaza koji su jako usitnjeni. Izdvajaju se ulomci tanjura (T. 26: 12).

Lokalitet je prema istoku u blagom padu, a na nekoliko mjesta je taj pad naglašen tako da su na tim mjestima stvorene manje „depresije“ s naplavinskim slojevima SJ 424, 504, 1018 i 1950 u kojima je pronađeno dosta nalaza.

#### **SJ 424** (sl. 5)

□ U 25/26, V 25; S–VII

▼ 117,22–117,16

Dimenzije: 10 x 11,7 m

Naplavinski sloj tamnosive boje koji sadrži dosta antičke keramike. Prevladavaju nalazi VKJ 2 strukture, ali ima i nešto keramike izrađene od VKJ 24 strukture. Pronađeni su i ulomci tarionika VKJ 13 strukture sa zelenoglaziranom unutrašnjom stijenkom. Od keramike VKJ 2 strukture našli smo L4 i Z1 (T. 27: 2, 3a–3b) te ulomke drški koje su vjerojatno pripadale L5 tipu lonaca. Lonac L2 izrađen je od rijetke VKJ 25 strukture. Pronađen je i ulomak staklene posude (T. 27: 4), (vidi poglavlje 4.1, kat. br. 7) i kamenog brusa (T. 27: 5), (vidi poglavlje 4.6, brus: kat br. 3).

#### **SJ 504** (sl. 4)

□ H/I 7/8, I 6; S–XII

▼ 117,39–117,06

Dimenzije: 5,8 x 8,5 m

Naplavinski sloj od crne zemlje s keramikom VKJ 2 strukture od koje se izdvaja lonac L3 (T. 28: 6). Pored keramike pronađeno je i staklo (T. 28: 7), (vidi poglavlje 4.1, kat. br. 8) i kameni brusovi (T. 28: 8–9), (vidi poglavlje 4.6, kat. br. 4–5). Pronađeni su i veći komadi lijepa s tragovima šiblja (T. 28: 10–11), (vidi poglavlje 3.7).

#### **SJ 1018** (sl. 7–8)

□ (L/K 25/26/27); S–XVII

▼ 118,26–118,09

Dimenzije: 31,5 x 10,1 m

Naplavinski sloj tamnisive boje. U gornjem dijelu uočene

### 2.3.4. Layers

Layer **SU 001** is a surface layer of humus in which a considerable amount of different, but very fragmented material was found. It covered the entire site. Some of the items are interesting and valuable findings that merit being mentioned and analyzed. Among the ceramic finds from the surface layer only fragments of large locally produced *dolia* (Pl. 26: 1), of a glass vessel (Pl. 26: 2), fragments of glass bracelets (Pl. 26: 3–5), bronze vessels (Pl. 26: 6–7), two rings (Pl. 26: 8–9), a core (Pl. 26: 10) and coins (Pl. 26: 11) are noteworthy.

Layer **SU 002** was discovered in the northern part of the site in areas VI and VII, alongside the recent channel. Quite a number of very fragmented findings were found in it. Fragments of plates (Pl. 26: 12) stand out.

There is a slight descend on the eastern part of the site, but in a few places this decline is accentuated so that smaller "depressions" developed, with alluvial layers SU 424, 504, 1018 and 1950 in which a large number of findings were uncovered.

#### **SU 424** (fig. 5)

□ U 25/26, V 25; A–VII

▼ 117.22–117.16

Dimensions: 10 x 11.7 m

Dark gray alluvial layer, which contains a lot of ancient ceramics. Findings of VKJ 2 fabric prevail, but there is also some pottery made of VKJ 24 fabric. Also found are fragments of a mortar of VKJ 13 fabric with green glazed inner walls. The ceramics made of VKJ 2 fabric include L4 and Z1 (Pl. 27: 2, 3a–3b) and fragments of handles that are likely to belong to L5 type pots. Pot L2 is made of a rare VKJ 25 fabric. A fragment of a glass vessel (Pl. 27: 4) (see chapter 4.1, Cat. No. 7) and of a grindstone (Pl. 27: 5) (see chapter 4.6, grindstone: Cat. No. 3) were also found.

#### **SU 504** (fig. 4)

□ H/I 7/8, I 6; A–XII

▼ 117.39–117.06

Dimensions: 5.8 x 8.5 m

Alluvial layer of black earth with pottery of VKJ 2 fabric, with a pot L3 (Pl. 28: 6) that stands out. In addition to the pottery, glass (Pl. 28: 7), (see chapter 4.1, Cat. No. 8) was found, as well as grindstones (Pl. 28: 8–9), (see chapter 4.6, Cat. Nos. 4–5). Larger pieces of daub with traces of wicker were also found (Pl. 28: 10–11) (see chapter 3.7).

#### **SU 1018** (fig. 7–8)

□ L/K 25/26/27; A–XVII

▼ 118.26–118.09

Dimensions: 31.5 x 10.1 m

Dark gray alluvial layer. In the upper segment, the ploughing ridges were observed, and after the removal of that layer, several postholes were discovered: 1273/1274,





su brazde od oranja, nakon skidanja sloja, uočeno je više stupova: 1273/1274, 1279/1280, 1281/1282, 1283/1284, 1285/1286, 1287/1288, 1289/1290, 1291/1292, 1297/1298, 1293/1294, 1295/1296, 1299/1300, 1303/1304, 1305/1306, 1307/1308, 1309/1310, 1311/1312, 1313/1314, 1315/1316, 1317/1318, 1319/1320, 1321/1322, 1323/1324, 1327/1328, 1461/1462, 1453/1454, 1455/1456, 1457/1458, 1459/1460.

Većina arheološkog materijala pripada keramici lokalne proizvodnje (VKJ 2), no postoje i ulomci sive panonske keramike (VKJ 4, 8), crveno pečene keramike (VKJ 13, 23), ulomak sigilate (proizvod radionice Rheinzabern) i kameni brus (T. 28: 8) i obrađeni odbojak s retušom na ventralnoj strani (T. 28: 9), (vidi poglavlje 4.4, brusovi: kat. br. 6 i kremeni: kat. br. 4).

Među keramičkim tipovima izdvajaju se lonac L4 (T. 28: 1), zdjela Z1 (T. 28: 2), poklopac (T. 28: 3) i zdjele (T. 28: 4–6). Također je pronađeno više ulomaka zelenoglaziranog kasnoantičkog tarionika.

#### SJ 1950 (sl. 11)

□ (F/G/H 9/10); S–XX

▼ 119.20/119.16–119.01

Dimenzije: 8 x 17,24 m

Pjeskoviti naplavinski sloj od sive boje u sektoru XX na nižem dijelu južnog dijela lokaliteta. Pronađeno je više različitih ulomaka keramike, VKJ 2, 4, 9, 13 i 14 strukture. Od ulomaka daju se definirati ulomak lonca VKJ 2 strukture, (T. 28: 10) i ulomak trbuha i ručke lonca sive panonske keramike, VKJ 4 strukture, (T. 10: 11). Pored keramike pronađeni su i manji ulomci lijepa.

### 2.3.5. Vrste objekata

Analiziranjem pojedinih stratigrafskih jedinica uočeno je kako je prisutno više tipova objekata. Gotovo je nemoguće bilo odrediti jasnu funkciju u većini slučajeva zbog malobrojnih nalaza i kompleksne stratigrafije. Osnovne kategorije objekata su:

#### - Nadzemni objekti

Riječ je uglavnom o kolibama sa središnjim redom stupova, a krovovi su bili na dvije vode. U stupovima koliba često su pronađeni mali ulomci nepogodni za dataciju i mrvice gara te je datacija izvršena na temelju nalaza iz jama, peći i poluukopanih objekata ukoliko je zaključeno da međusobno čine cjelinu. Manji objekti nemaju središnji red stupova i pretpostavlja se da su služili kao pomoćni objekti za spremanje alata, kao radni prostori ili stambeni objekt manje obitelji.

Definirana su ukupno 33 nadzemna objekta, različitih veličina i vjerojatno različitih funkcija. Veći objekti služili su za stanovanje. Ostaci lijepa s tragovima daske i kolaca govore u prilog tome kako su građeni kombinacijom drvenih

1279/1280, 1281/1282, 1283/1284, 1285/1286, 1287/1288, 1289/1290, 1291/1292, 1297/1298, 1293/1294, 1295/1296, 1299/1300, 1303/1304, 1305/1306, 1307/1308, 1309/1310, 1311/1312, 1313/1314, 1315/1316, 1317/1318, 1319/1320, 1321/1322, 1323/1324, 1327/1328, 1461/1462, 1453/1454, 1455/1456, 1457/1458, 1459/1460.

Most of the archaeological material belongs to locally produced ceramics (VKJ 2), but there are fragments of Pannonian gray pottery (VKJ 4, 8), red fired ceramics (VKJ 13, 23), a fragment of *sigillata* (product of Rheinzabern workshop) and a grindstone (Pl. 28: 8) and a fashioned flake with a retouch on the ventral side (Pl. 28: 9), (see chapter 4.4, grindstones: Cat. No. 6 and flint: Cat. No. 4).

Among the ceramic types, pot L4 (Pl. 28: 1), Z1 bowl (Pl. 28: 2), a lid (Pl. 28: 3) and a bowl (Pl. 28: 4–6) were identified. Also several fragments of a green glazed late Roman mortar were found.

#### SU 1950 (fig. 11)

□ (F/G/H 9/10); A–XX

▼ 119.20/119.16–119.01

Dimensions: 8 x 17.24 m

Gray, sandy alluvial layer in area XX at the lower part of the southern sector of the site. Several different fragments of pottery of VKJ 2, 4, 9, 13 and 14 fabric were found. Of all the fragments, a fragment of a pot of VKJ 2 fabric (Pl. 28: 10) and a fragment of the body and the handle of a pot of Pannonian gray pottery made of VKJ 4 fabric (Pl. 10: 11) can be defined. Besides the ceramics, some smaller fragments of daub were found.

### 2.3.5. Types of facilities

By analyzing individual stratigraphic units it was observed that there are several types of structures present. It is almost impossible to define a distinct function in most cases because of the small number of findings and a complex stratigraphy. The basic categories of structures are as follows:

#### - Surface structures

These are mostly huts with a central row of postholes, and they usually have gable roofs. In hut postholes, small fragments unsuitable for dating and crumbs of soot are often found, so the dating was performed based on findings from pits, hearths and pit houses, if it was concluded that they form a unit together. Smaller structures do not have a central row of postholes and are assumed to have been used as auxiliary facilities for storing tools, as well as work premises or a housing facility for a smaller family.

A total of 33 surface structures of different sizes and probably different functions were defined. Larger facilities were used for housing. The remains of daub with traces of boards and stakes speak in favour of how these structures were constructed by using a combination of wooden postholes and daub, reinforced by boards.



stupova i lijepa ojačani daskama.

U slučaju kompleksa 2 imamo očuvane velike komade lijepa, na nekim mjestima s tragovima daski (s vanjske strane, kao ojačanje?) koji su pronađeni u obližnjem kanalu. Budući da nisu pronađene tegule, za pretpostaviti je da su krovove prekrivali slamom. Stambeni objekti na užoj (uglavnom južnoj) strani (dobro vidljivo na sjevernom dijelu lokaliteta) imali su nadstrešnicu, nešto užu od širine samog objekta.

U dva objekta, u središnjem dijelu, otkriven je plitki ukop, sastavni dio objekta. U sjevernom dijelu lokaliteta gdje je manja koncentracija objekata bilo je lakše razlučiti ovakve objekte.

U selu Szakaly drvene kolibe datirane su isključivo u kasnoantičko razdoblje (Gabler 1982: 79). U slučaju Kiškorije, u kasnoantičkom razdoblju prisutni su poluukopani i nadzemni objekti. U slučaju kasnoantičkog objekta 642/643 vidimo kako je drvena koliba ranija od njega jer su njeni stupovi otkriveni tek na dnu ovog objekta.

#### - Poluukopani objekti

Plitko ukopani i djelomično ukopani objekti kao što je npr. SJ 404/405, imaju oko sebe stupove, a u zapunama su pronađeni veći komadi lijepa. Objekti su u potpunosti plitki ili imaju dio koji je dublje ukopan. Taj dublje ukopani dio vjerojatno je bio natkriven drvetom i služio je kao spremište tog pojedinog, vjerojatno stambenog objekta. Ovakav objekt imao je zidove od lijepa, ojačane drvenom konstrukcijom, stupovima, obrađenim daskama i šibljem, a mogao je služiti za stanovanje. Poluukopani objekti manjih dimenzija kao što je npr. 013/014 služili su za spremanje ili rad.

Pronađeno je osam ovakvih objekata.

#### - Jame

Pronađeno je 118 jama, različitih dimenzija, oblika i očuvanosti. U većini slučajeva nije bilo moguće odrediti njihovu funkciju.

#### - Kanali

Od 6 kanala koji su pronađeni nisu svi imali istu funkciju. Tako je duboki L kanal u kompleksu 2 imao na svojim rubovima paralelne stupove koje su tvorile njegovu nadstrešnicu i vjerjatno je imao neku radnu funkciju. Kanali u kompleksima 3 i 8 su plitki i vjerojatno označavaju razgraničavanje prostora. Kanal kao što je npr. SJ 007/008 u kompleksu 1 te slični ukopi u kompleksima 2 i 3 činili su mjesta temeljenja zidova nadzemnih objekata (koliba).

#### - Stupovi

Od 896 stupova, dio pripada određenim nadzemnim objektima, a dio je pripadao ogradama ili nedefiniranim objektima.

In the case of complex 2, large pieces of daub were preserved, with traces of boards in some places (from the outside, as reinforcement?) which were found in a nearby canal. Since no fragments of tegulae were discovered, it can be assumed that the roofs were covered with straw. Residential premises on the narrow (mainly southern) side (well visible in the northern part of the site) had a shed, slightly narrower than the overall width of the building itself.

In two structures, a shallow cut was discovered in the central part, which was an integral part of the building. In the northern part of the site, where the concentration of structures is lower, it was easier to distinguish structures of this type.

In the village of Szakaly, wooden huts are dated only to the late antique period (Gabler 1982: 79). In case of Kiškorija, in the late Roman period, half-buried and above-ground structures are present. On the example of a late Roman structure 642/643 we can see that the wooden hut is older than the late Roman structure because the hut postholes are discovered only at the bottom of this Roman structure.

#### - Pit houses

Shallowly buried objects and pit houses such as SU 404/405 had postholes around them, and in their backfills large pieces of daub were found. The buildings are completely shallow or have a part that is buried somewhat deeper. This deeply buried part was probably overshadowed by a tree and served as a storage of that individual, probably residential, structure. A structure of this type had walls made of daub, reinforced by wooden construction, postholes, processed boards and wattle, and could have been used for housing. Half-buried objects of smaller dimensions such as 013/014 were used as a storage or a workshop.

Eight such structures were found.

#### - Pits

A total of 118 pits of different sizes, shapes and condition were found. In most cases it was not possible to determine their function.

#### - Channels

Not all of the 6 channels that were discovered had the same function. Thus, the deep L-shaped channel in complex 2 had parallel postholes on its edges which formed its cover and which probably had some sort of a working function. Channels in complexes 3 and 8 are shallow and probably indicate the demarcation of space. Channel such as SU 007/008 in complex 1, and similar cuts in complexes 2 and 3, formed the wall foundations of above-ground facilities (huts).

#### - Postholes

A part of the 896 postholes belongs to certain above-ground structures, and others pertain to fences or undefined structures.



Sl. 133 Rekonstrukcija kuće s lokaliteta Virovitica Kiškorija jug od stupova, daske, lijepa, pruća i slame s trijemom  
Fig. 133 Reconstruction of the typical house from Virovitica Kiškorija south site, made of postholes, boards, daub, twigs and straw, with a porch

II DIO



PART II



3.

**Keramički oblici i njihov prostorni kontekst**

*Shapes of ceramics and their spatial context*





## Uvod i slikovni pojmovnik (stručnih naziva korištenih u obradi keramike)

### *Introduction and pictorial glossary (of scientific vocabulary used in the chapter on ceramics)*

Prije izlaganja tipoloških oblika smatram potrebnim objasniti pristup izradi same tipologije i odabir materijala koji je njome obuhvaćen. U katalog je uvršten onaj materijal koji ima dovoljno elemenata za prepoznavanje određenog oblika posude. Tipologija je izrađena za onu keramiku za koju se smatra da je proizvedena unutar mikroregije<sup>1</sup> kojoj pripada lokalitet.

U pokretnoj građi s lokaliteta Virovitica Kiškorija jug prevladavaju keramički predmeti, a od tog materijala zanemarivo mali broj ulomaka pripada keramici koja nije lokalne proizvodnje. Značajno je to što materijal potječe iz zatvorenih arheoloških cjelina od kojih je dio datiran <sup>14</sup>C analizom ugljena.<sup>2</sup> To je važno naglasiti budući da veći dio zatvorenih cjelina nije presječen drugim cjelinama te je <sup>14</sup>C datumom pouzdan pokazatelj trajanja oblika i vrste keramike na ovom lokalitetu.

Uočeno je kako je odabrani materijal prilično specifičan, odnosno da je unatoč postojanju analogija uvijek prisutan odmak od njih, a tamo gdje je objavljen opis strukture i tehnologije izrade jasno je kako se radi o vrlo različitom keramičkom materijalu te su to analogije samo u smislu oblikovanja posuda. Uvidom u keramičku građu drugih lokaliteta hrvatskog dijela Gornje Panonije strukturalna različitost naoko analognog materijala upečatljiva je, te ona zapravo najviše govori o lokalnom karakteru te keramike. Po strukturi i obliku keramike lokalne proizvodnje iz Kiškorije najviše odgovara keramika s lokaliteta Orešac koji je udaljen 20 km od Virovitice Kiškorije jug. Orešac – rimski *Bolentio* naselje je drukčijeg karaktera. Orešac je *mutatio*, ali i naselje na važnoj magistralnoj cesti s kućama građenim od kamena, ukrašenim mozaicima i opremljenim hipokaustima (Salajić 2008). Materijal iz Orešca raznovrstan je i bogat te pored lokalno proizvedene keramike ima i mnoštvo materijala koji je uvezen s udaljenih područja (od keramike, stakla, koštanih predmeta do metala). Svakako, istraživanja antičkih lokaliteta u bližoj okolici Orešca i Virovitice Kiškorije jug mogla bi pokazati slične rezultate. Na Virovitici Kiškoriji jug se može također naći keramike struktura kojih prema dosadašnjim istraživanjima u Orešcu

Prior to the presentation of typographical forms I consider it necessary to explain the method of creating the typology and the selection of materials described in it. The catalogue contains the material having enough elements to enable the identification of the particular form of the vessel. The typology describes the ceramics that is believed to have been produced within the micro region<sup>1</sup> of the site.

Mobile finds from Virovitica Kiškorija south site mostly consist of ceramic items, and only a negligibly small number of fragments of pottery were not of local production. It is significant that the material came from closed archaeological units which were dated by <sup>14</sup>C analysis of coal.<sup>2</sup> This is important to be emphasized, since most of the closed units are not intersected by other units and, therefore, <sup>14</sup>C dates are a reliable indicator of the continuance of the forms and types of pottery at this site.

It was noted that the selected material was rather specific, meaning that despite the evident analogies there have always been some differences. When it was possible to consider the published descriptions of fabric and production technology, it was clearly noted that this was a very different ceramic material and that analogies corresponded only in terms of vessel design. Following the examination of the ceramic material from other sites of the Croatian part of Upper Pannonia, the impressive fabric diversity of seemingly analogous materials was determined, and it definitely confirmed the local character of these ceramics. As for its fabric and form, locally produced ceramics from Kiškorija mostly resemble ceramics from the site Orešac located 20 km from Virovitica Kiškorija south. Orešac – Roman *Bolentio* was a settlement of a different character. Orešac was a *mutatio*, but also a settlement on an important main road with houses built of stone, decorated with mosaics and equipped with hypocaust (Salajić 2008). Material from Orešac is diverse and rich, and in addition to locally produced ceramics contains a lot of material that was imported from remote areas (ceramics, glass, objects made of bones, metal). Surely the exploration of ancient sites in the immediate vicinity of Orešac and Virovitica Kiškorija south might show similar results. On Virovitica Kiškorija south ceramics were distinguished with fabric of the kind that had not be-

1 Za definiranje mikroregija vidjeti poglavlje 3.5.

2 Analize su izrađene u laboratorijima u Leibniz Labor für Altersbestimmung und Isotopenforschung, Christian-Albrechts Universität, Kiel i u Beta Analytic Inc., Miami, Florida.

1 About defining micro regions see chapter 3.5.

2 The analyses were performed in laboratories in Leibniz Labor für Altersbestimmung und Isotopenforschung, Christian-Albrechts Universität, Kiel i u Beta Analytic Inc., Miami, Florida.





nema, ali i obrnuto.

Uvidom u keramičku građu s lokaliteta: Jalžabet (Jelinčić 2009: T. 43–51), Ludbreg (Jelinčić 2009: T. 52–59), Komin (Jelinčić 2009: T. 67–71), materijala s različitih položaja u Sisku (Jelinčić 2009: T. 113–132), keramike iz Topuskog (Jelinčić 2009: T. 106–112), Ščitarjeva (Jelinčić 2009: T. 89–112), Okuja (Jelinčić 2009: T. 86–88) i Šepkovčice (Jelinčić 2009: T. 76–85) uočeno je kako je uporabna keramika lokalne proizvodnje tih lokaliteta oblikom, tehnologijom i ukrašavanjem bitno drukčija od uporabne keramike lokalne proizvodnje Virovitice Kiškorije jug. Također, uočeno je kako postoje znatne sličnosti između materijala iz Jalžabeta, Petrijanca i Ludbrega (Jelinčić 2009: T. 43–66), a po nekim oblicima i s materijalom iz Komina (Jelinčić 2009: T. 67–71). Uočene su sličnosti na lokalitetima kod Velike Gorice i Ščitarjeva, ali i brojne specifičnosti tih lokaliteta. Svaki lokalitet ima keramiku koja je posebna i susreće se samo na tom lokalitetu. Uz to uvijek postoji i ona kategorija keramike koja se susreće i na susjednim lokalitetima, te keramika koja je srodna tipološki, ali se strukturalno jako razlikuje (Vikić-Belančić, Gorenc 1958: 110, T. XVII, 53; Vikić-Belančić 1968b: T. IX: 12, 13a, 13b; Šarić 1975: 59, T. XI: 1–5). Ove činjenice govore u prilog postojanju zasebnih područja unutar kojih su keramiku proizvodili lončari koji su tom posuđu dali posebna i samo za taj kraj karakteristična obilježja. Keramički tipovi koji se ovdje razrađuju prisutni su u velikom broju u Orešcu i na Virovitici Kiškoriji jug te se mogu smatrati vrlo karakterističnim za to područje. Uvidom u materijal i objavljenu keramiku okolnog područja s obzirom na odmake i strukturalnu i tehnološku različitost dobiva se dojam kako su prisutne analogije više slučajnost nego redovna pojava većih razmjera.

Zbog svega navedenog može se reći kako se sama tipologija odnosi prvenstveno na uporabnu keramiku lokalne proizvodnje mikroregije kojoj pripadaju Orešac i Virovitica Kiškorija jug. U tipološkoj obradi pažnja je usmjerena na oblik posuda, oblikovanje (kolo ili bez njega), datiranje i eventualne analogije. Strukture od kojih su izrađene pojedine posude zasebno su su obrađene.

Budući da u hrvatskom jeziku za sada ne postoji arheološki terminološki rječnik koji bi se odnosio na keramičko posuđe te se u literaturi koriste neujednačeni termini, u ovom poglavlju se prilaže kratki pojmovnik kako bi čitatelji, posebno oni koji nemaju iskustva s rimskom keramikom, lakše pratili tekst o keramičkom posuđu s njegovim najosnovnijim pojmovima (sl. 134).

**Bočna stijenka** (eng. *wall*; germ. *Wand*; tal. *parete*; fra. *paroi*) čini dio posude npr. između dna i ramena ili u slučaju poklopca između oboda i ručke.

**Dno** (eng. *base*; germ. *Boden*; tal. *fondo* fra. *base*) je donji dio posude na kojemu ona stoji. Može biti oblikovano ravno, konveksno ili može imati različito oblikovanu nogu (eng. *foot* germ. tal. *piede*; fra. *ped*).

**Fino stolno posuđe** (eng. *tableware*; germ. *Feinware*;

en found in Orešac during previous research, but it is also true the other way around.

During the examination of the ceramic material from sites: Jalžabet (Jelinčić 2009: T. 43–51), Ludbreg (Jelinčić 2009: T. 52–59), Komin (Jelinčić 2009: T. 67–71), materials from different positions in Sisak (Jelinčić 2009: T. 113–132), ceramics from Topusko (Jelinčić 2009: T. 106–112), Ščitarjevo (Jelinčić 2009: T. 89–112), Okuje (Jelinčić 2009: T. 86–88) and Šepkovčica (Jelinčić 2009: T. 76–85), it was observed that the locally produced functional ceramics from these sites by its form, technology and decorations significantly differ from locally produced functional ceramics from Virovitica Kiškorija south. It was also noted that there were significant similarities between the materials from Jalžabet, Petrijanec and Ludbreg (Jelinčić 2009: T. 43–66), and by some forms, to the material from Komin as well (Jelinčić 2009: T. 67–71).

Similarities were observed on sites near Velika Gorica and Ščitarjevo, but also many specifics of these sites. On each site ceramics were found that are particular only to a specific site. In addition, there is always a category of pottery which can be found on neighbouring sites, and ceramics that is typologically related, but with very different fabric (Vikić-Belančić, Gorenc 1958: 110, T. XVII, 53; Vikić-Belančić 1968b: T. IX 12, 13a, 13b; Šarić 1975: 59, T. XI: 1–5). These facts indicate the existence of separate areas within which the ceramics were produced by potters giving them special features characteristic for a specific region. Ceramic types which are elaborated here are present in large numbers in Orešac and on Virovitica Kiškorija south and can be considered typical for that area. After examining the material and published ceramics from surrounding areas considering the deviations and fabric and technological diversity, one gets the impression that present analogies are more of a coincidence than a regular occurrence on a larger scale.

Having considered the above mentioned facts we can state that the typology itself is primarily related to functional ceramics locally made in the micro region to which Orešac and Virovitica Kiškorija south belong. In the course of the typological interpretation the focus was on the forms of vessels, moulding (by hand or on potter's wheel), dating and possible analogies. The fabrics of individual vessels were elaborated separately.

Since, for the time being, there is no archaeological glossary in the Croatian language that could be applied to ceramic dishes, different terms are being used in the literature. Therefore, this section will enclose a short glossary with basic terms, to help the readers, especially those who have no experience with Roman pottery, understand the text on ceramic dishes (fig. 134).

**Wall** (cro. *bočna stijenka*; germ. *Wand*; tal. *parete*; fra. *paroi*) is the part of the vessel between the base and the shoulder, or on the lid, between the rim and the handle.

**Base** (cro. *dno*; germ. *Boden*; tal. *fondo*; fra. *base*) is the lower part of the vessel on which the vessel stands. It can be flat, convex, or it may have differently shaped leg (cro.



tal. *ceramiche fini da mensa*; fra. *céramique fine de table*). Keramika izrađena od kvalitetne strukture, ponekad ukrašena različitim tehnikama, namijenjena serviranju hrane ili pića.

**Obod** (eng. *rim*; germ. *Rand*; tal. *orlo*; fra. *bord*) vanjski dio posude odnosno njezin otvor. Obod može biti različito oblikovan: ukošen, zaobljen, cilindričan. Rub oboda može biti također različito oblikovan (npr. zaobljen, koso odrezan...). Obod se nastavlja na vrat u slučaju npr. vrča ili se nastavlja na bočne stijenke u slučaju npr. poklopca.

**Panonska siva keramika** (eng. *Pannonian greyware*; germ. *Pannonische grauware* odnosno *Pannonische Glanzton Ware*; tal. *ceramica grigia pannonica*, fra. *céramique gris de Pannonie*) je jako zastupljena vrsta keramike u Panoniji. Odnosi se na posuđe, često premazano sjajnim crnim ili sivim premazom, a ponekad ukrašeno kotačićem i pečatima (*Pannonische Glanzton Ware*). Oblici ponekad imitiraju teru sigilatu, ali se i koriste oblici koji su karakteristični samo za Panoniju. Najbrojnije su zdjele. Pored njih izrađuju se vrčevi i lonci bez sjajnog premaza (*Pannonische grauware*), s vrlo tankim mat premazom.

**Posude za pohranu namirnica – doliji** (lat., eng., germ., tal., fra. *dolium*, *dolia*). Posude u kojima se moglo čuvati/skladištiti krute i tekuće namirnice. Često je prisutna pogreška pa se ove posude naziva *pithos*–pogreška zbog toga što je to grčki naziv, a ako govorimo o rimskodobnom posuđu onda možemo reći *dolium*, dolij ili posuda za pohranu namirnica.

**Primjese** (eng. *temper*, *inclusions*; germ. *Einschlüsse*; tal. *inclusioni*; fra. *Dégraissant*). U strukturi keramičkog predmeta mogu se pronaći različiti elementi koji se mogu nalaziti u sirovini (glini) (inkluzije), ali su primjese ujedno i oni elementi koje su lončari mogli dodati namjerno u glinu kako bi posuđe dobilo određena svojstva (*temper*). Primjese mogu biti: ulomci školjaka ili puževa, pijesak, mrvljena keramika, biljke, kremen, tinjac (quartz, mica). S obzirom da na virovitičkom posuđu nisu napravljene analize keramike i gline, ne znamo kakvog su porijekla uočene primjese.

**Rame** (eng. *shoulder*; germ. *Schulter*; tal. *spalla*; fra. *épaule*) je dio posude ispod vrata, odnosno predstavlja prijelaz u tijelo posude. Može biti ukošeno, zaobljeno, nabrebreno.

**Rub** (eng. *lip*, germ. *Lippe*, tal. *labbro*, fra. *levre*) je krajnji dio površine oboda te može biti oblikovan na različite načine: zaobljen, ravan, ukošen, šiljat...

**Struktura keramike** (eng. *fabric*; germ. *Fabricat*; tal. *impasto*; fra. *pâte*) podrazumijeva materijal od kojeg je izrađena keramička posuda: glinu, primjese (inkluzije i *temper*), način na koji je pečena, izgled, boja (pri svježem lomu!) i tvrdoća. Ona se prvo definira makroskopskim promatranjem i pipom, zatim se definira pod lupom, a nakon grupiranja ukupne keramičke građe na pojedine strukture njezin se opis zapisuje. Kada je to moguće, potrebno je izvesti geokemijske analize kako bi se došlo do novih odgovora: porijeklo strukture (lokalno ili uvezeno), sastav

*noga*, germ. tal. *piede*; fra. *piéd*).

**Tableware** (cro. *fino stolno posuđe*; germ. *Feinware*; tal. *ceramiche fini da mensa*; fra. *céramique fine de table*). Ceramics made with a high-quality fabric, sometimes decorated with various techniques, designed for serving food or drinks.

**Rim** (cro. *obod*; germ. *Rand*; tal. *orlo*; fra. *bord*) the outside of the vessel, that is, its opening. It can be differently formed: slanted, curved, cylindrical. The edge of the rim may also be differently formed (e.g. curved, slanted ...). The rim exceeds into the neck in case of, for example, a jug, or it exceeds into walls in case of a lid.

**Pannonian greyware** (cro. *Panonska siva keramika*, germ. *Pannonische grauware* that is *Pannonische Glanzton Ware*, tal. *ceramica grigia pannonica*, fra. *céramique gris de Pannonie*) is a very largely represented type of ceramics in Pannonia. It refers to the dishes, often painted with a glossy black or gray coat, and sometimes with rouletting or sealed decoration (*Pannonische Glanzton Ware*). The forms sometimes imitated *terra sigillata*, but also forms that are specific to Pannonia were often used. The most numerous were bowls. Also, jugs and pots without glossy coating were made (*Pannonische grauware*), with a very thin matte finish.

**Dolia** (lat., cro., germ., tal., fr. *dolim*, *dolia*). Vessels used for keeping/storing of solid and liquid foods. These vessels are often called *pithos*, which is wrong because that is a Greek name, and if we discuss the Roman times and the Roman pottery then we can use the term *dolium* or vessels for food storage.

**Inclusions/temper** (cro. *primjese*; germ. *Einschlüsse*; tal. *inclusioni*; fra. *Dégraissant*). Various elements may be found within the fabric of the ceramic items that may be part of the raw material itself (clay) (inclusions), or may have been blended deliberately into the clay by potters to give pottery certain characteristics (*temper*). Inclusions/temper may be fragments of shells or snails, sand, triturated ceramics, plants, quartz, mica. Since the analysis of the ceramics and clay of the dishes from Virovitica has not been made, we cannot be sure about the origin of the inclusions/temper.

**Shoulder** (cro. *rame*; germ. *Schulter*; tal. *spalla*; fra. *épaule*) is a part of the vessel below the neck, i.e. it makes the transition to the body. It can be oblique, rounded, ribbed.

**Edge, lip** (cro. *rub*, germ. *Lippe*, tal. *labbro*, fra. *levre*) is the end portion of the rim and it may be moulded in various ways: rounded, flat, oblique, pointed...

**Fabric** (cro. *struktura keramike*; germ. *Fabricat*; tal. *impasto*; fra. *pâte*) includes the material used for making a ceramic vessel: clay, impurities (inclusions and *temper*), the way of firing, appearance, colour (at fresh break) and hardness. The definition of the fabric is performed primarily by the macroscopic observation and palpation, later the magnifier is used, and only after the grouping of the total ceramic material by individual fabrics, the description may be recorded. When possible, it is necessary to perform geochemical analysis in order to come up with new results: to define the origin of fabric (local or imported) and com-



(u odnosu na sirovinu), potvrdio broj struktura utvrđen makroskopskim promatranjem te utvrdio broj lokalnih struktura.

**Uporabna keramika lokalne proizvodnje** (eng. *locally produced functional ceramics*; germ. *Local hergestellte Gebrauchskeramik*; tal. *ceramica comune di produzioni locale*; fr. *ceramiques communes de production locale*) Pod ovim podrazumijevam svu keramiku koja se koristila za kuhanje, čuvanje i serviranje hrane, a proizvedena je unutar naselja ili u njenoj neposrednoj blizini te nije bila namijenjena za prodaju na udaljenim tržištima.

**Vrat** (eng. *neck*; germ: *Hals*; tal: *collo*; fra. *col*) je dio posude između ramena i oboda posude. On može biti zaobljen, cilindričan, ukošen...

position (in terms of raw material), to confirm the number of fabrics determined by macroscopic observation and to determine the number of local fabrics.

**Locally produced functional ceramics** (cro. *uporabna keramika lokalne proizvodnje*; germ. *Local hergestellte Gebrauchskeramik*; tal. *ceramica comune di produzioni locale*; fr. *ceramiques communes de production locale*)

This term implies all of the ceramics used for cooking, storing and serving the food, which is produced within the settlement or in its direct vicinity and was not intended for trade in distant markets.

**Neck** (cro. *vrat*; germ: *Hals*; tal: *collo*; fra. *col*) is a part of the vessel between the shoulder and the rim. It can be rounded, cylindrical, oblique...

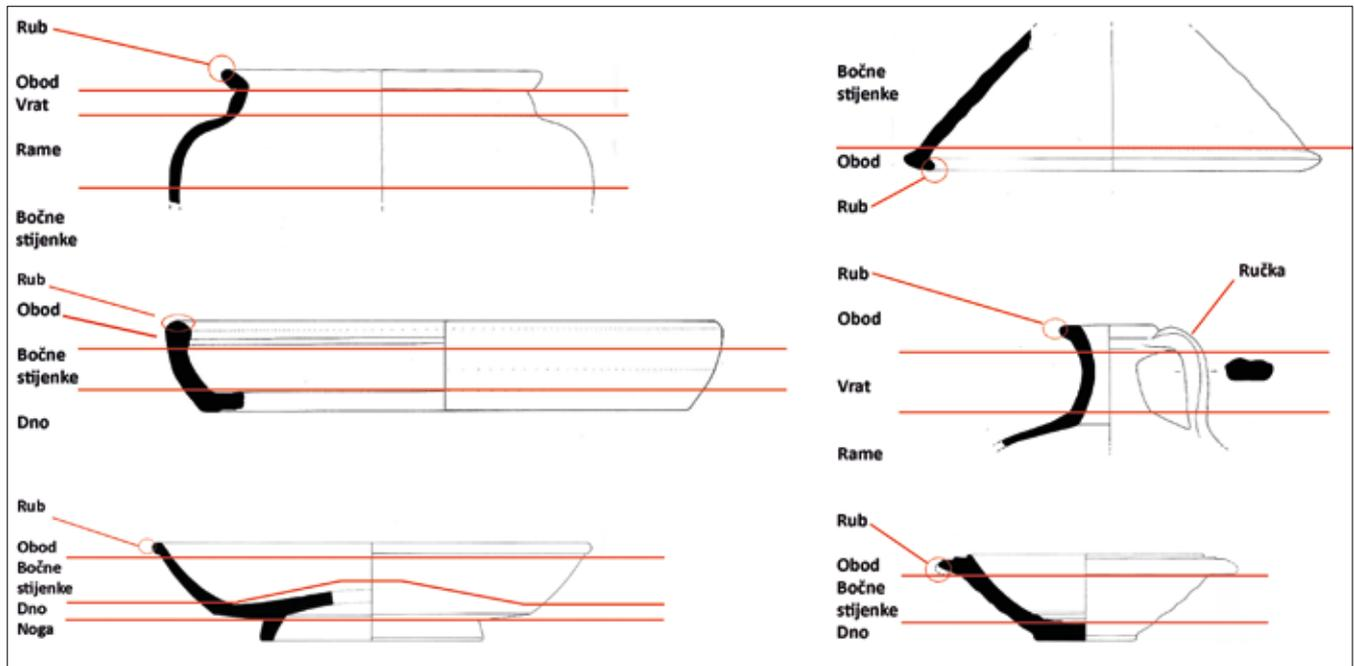

Sl. 134 Djelovi posuda

Fig. 134 Parts of the vessels (*rub*=edge; *obod*=rim; *vrat*=neck; *rame*=shoulder; *bočna stijenska*=wall; *dno*=base; *noga*=foot; *ručka*=handle)

## Strukture keramičkog posuđa *The fabrics of ceramic dishes*

Za potpuno razumijevanje keramičkog materijala nekog lokaliteta, područja i vremenskog razdoblja važno je pored tehnologije poznavati i samu strukturu tog keramičkog materijala. Ona se razlikuje od predmeta do predmeta (Miletić 2007: 348), a na početku obrade materijala bitno je izdvojiti pojedine strukture, odnosno grupirati keramički materijal po zajedničkim karakteristikama pojedinih struktura.

Makroskopskim promatranjem ukupnog keramičkog materijala s *Virovitice Kiškorije jug*, izdvojeno je 29 struktura. Od tih, 83 % čini keramika strukture VKJ 2, 4% struktura VKJ 16 i VKJ 23, 2% strukture VKJ 19, te sa po 1% strukture VKJ 1, VKJ 4, VKJ 8, VKJ 24, VKJ 25, VKJ 26 i VKJ 27 (Grafikon 1–2).

Dio nalaza nije priključen nijednoj strukturi jer se radi o pojedinačnim nalazima.<sup>1</sup>

Za potpuno razumijevanje struktura, trebalo bi primijeniti i geokemijske analize (kada to financijska sredstva omogućavaju), budući da se tek mikroskopskim promatranjem mogu dobiti svi podaci o pojedinoj strukturi, a makroskopska opažanja se tako mogu i provjeriti. Vaganjem svih ulomaka, svih struktura iz *Virovitice Kiškorije jug* dobiveni su slijedeći rezultati i odnosi: struktura VKJ 2 je najzastupljenija s 12,263 kg, zatim struktura VKJ 19 s 4,189 kg te struktura VKJ 24 s 2,182 kg (Grafikon 2). Ovi podaci važni su jer je utvrđeno kako su najzastupljenije one strukture od kojih je izrađena uporabna keramika lokalne proizvodnje.

Bez obzira na karakter proizvodnje keramike, u proizvodnom procesu postoje neke bitne zajedničke karakteristike: nabava sirovine, priprema sirovine, oblikovanje posude, pripreme za pečenje, sušenje, pečenje i postupci nakon pečenja (Orton et al. 1994: 114). Što se tiče proizvodnje lokalne keramike na Virovitici Kiškoriji jug, ako uzmemo u obzir količinu keramike izrađene od strukture VKJ 2, možemo s velikom sigurnošću pretpostaviti da se proizvodila na lokalitetu ili u neposrednoj blizini. Ako je za proizvodnju neophodna glina, ona postoji na samom lokalitetu, budući da je dio zdravice (u arheološkom smislu) na lokalitetu glina. Na mjestima gdje je zdravica bila pijesak, ispod nje se također nalazi glina. Nedaleko od lokaliteta nalazi se potok Ođenica što je važno jer je

For a complete understanding of the ceramic materials from the specific site, the area and the time period, in addition to the technology, it is important to know the fabric of the ceramic material as well. It varies in different items (Miletić 2007: 348). Prior to the interpretation of the material it is essential to single out individual fabrics, namely, to group the ceramic material by general characteristics of individual fabrics.

By macroscopic observation of the complete ceramic material from *Virovitica Kiškorija south*, 29 fabrics were distinguished. Thereof, 83% are ceramics with VKJ 2 fabric, 4% are those with VKJ 16 and VKJ 23 fabric, 2% with VKJ 19 fabric, and each of VKJ 1, VKJ 4, VKJ 8, VKJ 24, VKJ 25, VKJ 26 and VKJ 27 fabrics contribute by 1% (Graph 1–2).

A certain number of the findings are not attributed to any fabric because those are individual finds.<sup>1</sup>

In order to fully comprehend the fabrics, geochemical analysis should also be carried out (when funds allow it), since all the data on the particular fabric can be obtained only by the microscopic examination, and, simultaneously, the macroscopic observations are being verified. By weighing all of the fragments of all fabrics from *Virovitica Kiškorija south*, the following results were obtained and relations determined: fabric VKJ 2 is the most prevalent weighing 12.263 kg, followed by fabric VKJ 19 weighing 4.189 kg and fabric VKJ 24 weighing 2.182 kg (Graph 2). These data are important because it was determined that the most common are the fabrics used locally for producing functional ceramics.

There are some important common features in the manufacturing process, regardless of the aspects of the ceramic production: the procurement of raw materials, raw material preparation, vessel moulding, firing preparation, drying, firing and procedures after firing (Orton et al. 1994: 114). As for the local production of ceramics in *Virovitica Kiškorija south*, taking into account the amount of pottery made of fabric VKJ 2, we can assume with great certainty that it was produced on the site itself or in its vicinity. If clay was necessary for the production of ceramics, it was already present at the site, since clay was a part of the sterile soil (in archaeological terms) at the site. In places where the sterile soil was composed of sand, under it there was

1 Ukoliko su takvi nalazi uključeni u katalog, njihova struktura je opisana u samom katalogu.

1 In case findings of this type are included in the catalogue, their structure is described in it.



Sl. 135 Ulomci posude rađene rukom, L1 tip, struktura VKJ 2  
 Fig. 135 Fragments of a handmade vessel, type L1, fabric VKJ 2

also clay. Not far from the site there flows a stream Ođenica which is important because water was important for the production of ceramics, as well as for the life in the settlement. South to the settlement Bilogora is located which is heavily forested nowadays, and it can be assumed that in ancient times this was the area with ample forest, i.e. fuel for firing the pottery. This means that in the village itself and its immediate surroundings the raw material could be found, and that the production of ceramics was theoretically possible.

Following the collection, the raw material had to be prepared; it was cleaned of excessive rocks, roots and other organic matter. In the ceramics with fabric VKJ 2 and VKJ 19 cracks were found on the surface and in its cross-section. They may suggest the presence of the organic matter, but it is impossible to determine whether these are organic substances present due to poorly purified clay or if they were added to clay in order to ease the forming.

Plastics mass for shaping the vessels was acquired by adding water to clay. In case of fabric VKJ 2 vessels were mostly made by hand (fig. 135–138), and only a smaller part was finalized on a wheel. It is difficult to establish a precise technique of making this pottery by hand. Given that these are larger vessels, it can be assumed that they were made using the cylindrical (*rolls, coils, coiling*) or ribbon-shaped clay which was arranged in a circle or a spiral and then sleeked afterwards (Rye 1988: 67–69). This is cle-



Sl. 136 Obod s unutrašnje strane posude koji nije u potpunosti spojen s tijelom lonca, L1 tip, struktura VKJ 2  
 Fig. 136 The rim on the inside of a vessel, which is not fully connected to the body of a pot, type L1, fabric VKJ 2



za izradu keramike, ali i za život samog naselja voda bila važna. Južno od naselja nalazi se Bilogora koja je danas gusto pošumljena, te je za pretpostaviti je da je u antici bilo na tom području dovoljno šume, odnosno goriva za pečenje keramike. Znači, osnovna potreba za sirovinom zadovoljena je u samom naselju i njegovoj užoj okolici i teoretski je bila moguća.

Sirovina se nakon prikupljanja pripremala, odnosno čistila od suvišnog kamenja, korijenja i drugih organskih tvari. U keramici strukture VKJ 2 i VKJ 19 prisutne su pukotine na površini i u njenom presjeku. One mogu ukazivati na postojanje organskih tvari, ali je nemoguće utvrditi radi li se o organskim tvarima koje su prisutne zbog loše pročišćene gline ili su dodavali glini travu kako bi je lakše oblikovali.

Dodavanjem vode glini dobivena je plastična masa kojom su oblikovane posude. U slučaju strukture VKJ 2 posude su većim dijelom rađene rukom (sl. 135–138), a manji dio dorađen na kolu. Teško je ustanoviti točnu tehniku izrade ove keramike rukom. S obzirom na to da se radi o većim posudama, za pretpostaviti je da su posude izrađene od valjkasto (*rolls, coils, coiling*) ili vrpčasto oblikovane gline koja se slagala u kružnicu ili spiralu, a ti valjkasti ili vrpčasti dijelovi naknadno su zaglađivani (Rye 1988: 67–69). To je naročito jasno kada se pogleda spoj vrata i oboda lonaca gdje se dobro vidi kako oni nisu do kraja spojeni (sl. 136) i gdje su dobro vidljivi otisci prstiju i noktiju lončara.

Nešto su brižnije izrađivani tanjuri i zdjele, vjerojatno su dorađivani na kolu. Na površini keramike se u većini slučajeva strukture VKJ 2 nanosio premaz, a njegova uloga s unutrašnje strane svakako je smanjivanje poroznosti posude. Premaz s vanjske strane mogao je imati i dekorativnu funkciju. U slučaju keramike strukture VKJ 2 taj je premaz lošije očuvan od premaza na keramici srodne strukture O

arly evident by looking at the joint of the neck and a rim of the pots where it is obvious that they were not connected completely (fig. 136) and also the fingerprints and nail impressions of potters can clearly be seen.

Plates and bowls were made more carefully and were probably finalized on a wheel. In most cases when the fabric VKJ 2 was used, a slip was applied on the surface of ceramics, and its purpose on the inner side was to reduce the porosity of the vessel. The slip on the outside surface could have had a decorative function. The slip on the ceramics made of fabric VKJ 2 is worse preserved than the slip on the ceramics made of a similar fabric of O 2 from the site Orešac (Jelinčić 2009) which could be explained by the characteristics of the soil in which the pottery was found.

Vessels are fired after the drying. At the site several stokeholes of small kilns were found which are assumed to have been used for cooking rather than for firing of ceramics. This assumption is supported by the fact that following the soil flotation the remains of food were found in these units (see chapter 5.1–5.2).

Other than in simple kilns, handmade ceramics could have been fired on an open fire by stacking firewood and laying vessels on it and firing them. This was a practical method since it did not require a full capacity of the furnace, and the procedure was faster. Time required for firing in this manner depended on the type of fuel, since some sorts of wood reach its maximum temperature quickly, while some burn slower, so consequently the ceramics are fired more slowly (Orton et al. 1994: 127). Other than fabric VKJ 2, fabrics VKJ 1, 14, 24, 28, 29 also stand out by their quantity. When compared, they are very similar, but they differ greatly from the fabric VKJ 2 due to the large amount of inclusions of mica and quartz. In fabric VKJ 2 none of these inclusions can be traced, only sand. Ceramics that



Sl. 137 L3, ulomak lonca izrađenog rukom, s otiscima prstiju na unutrašnjoj strani, struktura VKJ 2  
Fig 137 L3, fragment of a handmade pot, with fingerprints on the inside, fabric VKJ 2



Sl. 138 Ulomak lonca izrađenog rukom, L3, struktura VKJ 2  
 Fig. 138 Fragment of a handmade pot, L3, fabric VKJ 2

2 s lokaliteta Orešac (Jelinčić 2009) što može imati veze s obilježjima zemlje u kojoj je keramika pronađena.

Nakon sušenja posude, ona se peče. Na lokalitetu je pronađeno nekoliko ložišta manjih peći za koje se pretpostavlja da su služile za kuhanje, a ne pečenje posuda. Tu pretpostavku podupire i činjenica što su flotacijom zemlje, u tim cjelinama pronađeni ostaci hrane (vidi poglavlje 5.1-5.2).

Rukom rađena keramika se, osim u pećima jednostavnog tipa, mogla peći i na otvorenoj vatri tako da je naslagan sloj ogrijeva, na njega je položeno posuđe te je tako pečeno. Ovo je praktičan način budući da ne zahtijeva potpuno punjenje kapaciteta peći, a i sam postupak je brži. Brzina koja je potrebna za pečenje na ovaj način ovisi i o vrsti ogrjeva budući da neka vrsta drva brže dostiže svoju maksimalnu temperaturu, dok se kod druge vrste sporije razvija pa se takva keramika i sporije peče (Orton et al. 1994: 127). Pored strukture VKJ 2, svojom količinom zanimljive su strukture VKJ 1, 14, 24, 28, 29. One su međusobno slične, a jako se razlikuju od strukture VKJ 2 zbog velike količine primjesa tinjca i kvarca. U strukturi VKJ 2 tih primjesa nema, a prisutan je isključivo pijesak. U obližnjem Orešcu takve keramike, koja bi strukturalno nalikovala keramici struktura VKJ 1, 14, 24, 28, 29, nema (Jelinčić 2009). To bi moglo značiti da, iako navedene strukture nisu brojne, čine lokalnu specifičnost Virovitice Kiškorija jug.

Struktura VKJ 2 zbog velike je količine pijeska mogla biti pečena na nižim temperaturama (Šimić-Kanaet 1999: 82; Miletić 2007: 352) što je u svakom slučaju povoljno za ovu lokalno proizvedenu keramiku, budući da je ona vjerojatno pečena ili u jednostavnim pećima ili na otvorenom

would structurally resemble ceramic fabrics VKJ 1, 14, 24, 28, 29, had not been found in the nearby Orešac (Jelinčić 2009). This could be the proof that although these fabrics are not numerous, they do present a local specificity of Virovitica Kiškorija south.

Fabric VKJ 2 could be fired at lower temperatures because of the large amount of sand (Šimić-Kanaet 1999: 82; Miletić 2007: 352), which was certainly convenient for local production of ceramics, since it was probably fired in simple kilns or on an open fire. Dishes made of fabrics VKJ 1 VKJ 14, VKJ 24, VKJ 28, VKJ 29 were exceptionally suitable for cooking because of the inclusions of quartz and mica. Quartz, sand and mica, when added to clay, are suitable for the production of cooking vessels, since the vessels which comprise them in their fabric tolerate temperature changes (Miletić, 2007: 351–352). Size of the inclusions in the formation of the vessel depends proportionally on the size of the vessel itself, that is, the inclusions are bigger if the vessel is larger and if its walls are thicker (Rye 1988: 27).

However, there is a notable amount of sand present in the fabric VKJ 2 and also the voids can be seen in its cross-section, which are the result of burning of the inclusions of vegetable origin. Sand and voids also ensured resistance to thermal shocks and allowed cooking and reheating in such vessels, provided the vessel was coated to make the surface non-porous. The shape of the vessel should not be disregarded since it was as important for its resistance to thermal shocks as was the fabric. Constant wall thickness, rounded base and simplicity of forms were also important (Rye 1999: 27). Potters used to add various inclusions to the clay in order to facilitate the forming of vessels or to achieve adequate performance characteristics essential for the



ognjištu. Posuđe izrađeno od struktura VKJ 1, VKJ 14, VKJ 24, VKJ 28, VKJ 29 je zbog svojih primjesa kvarca i tinjca bilo izuzetno pogodno za kuhanje. Kvarc, pijesak i tinjac dodani glini pogodni su za izradu posuda za kuhanje, budući da posuda koja ih sadrži u svojoj strukturi dobro podnosi temperaturne promjene (Miletić 2007: 351–352). Veličina primjesa pri formiranju posude ovisi proporcionalno o veličini same posude, odnosno što je veća posuda i što su deblje stijenke to su njezine primjese veće (Rye 1988: 27).

Ipak, zamjetna je količina pijeska u strukturi VKJ 2 kao i postojanje šupljina u njenom presjeku, koje su nastale izgaranjem primjesa biljnog porijekla. Pijesak i šupljine također omogućavaju otpornost na temperaturne šokove i omogućavaju kuhanje i podgrijavanje u posudama koje ih sadržavaju uz uvjet da postoji premaz koji sprječava poroznost površine. Pored same strukture ne treba ni zanemariti oblik posude koji je također važan za njenu otpornost na temperaturne šokove. Važna je ujednačena debljina stijenke, zaobljeno dno i jednostavnost oblika (Rye 1999: 27). Lončari su dodavali različite primjese glini kako bi olakšali formiranje posuda ili kako bi postigli odgovarajuće karakteristike bitne za korištenje samih po-

use of the vessels (Rye 1988: 31).

On Virovitica kiškorija south site locally made functional pottery prevails. Examples of tableware are rare. Since this is rural environment, it would be expected that prehistoric traditions prevailed in it. Lack of tableware, ceramics characteristic for Roman antiquity (the absence of oil lamps and amphorae, scarce mortaria), also indicate a strong prehistoric tradition. This conclusion is based on the finds proving that cooking and food preparation ceramics became different from tableware which was used shortly before the Roman authorities came into power, while with the arrival of the Romans bringing their own customs, this distinction grew stronger (Cool 2006: 53).

Multiple soil samples from the site were analyzed, and increased acidity has been found. This is probably the main cause of poor preservation, not only of pottery but also of other findings, especially organic ones.<sup>2</sup> This assumption is supported by the fact that the high quality ceramics such as *sigillata* are also poorly preserved and deteriorating. As for the preservation of the slip, I believe that it is impos-

<sup>2</sup> Ph analyses carried out by Z. Sedlar PhD, Department of Biology, Faculty of Science, Zagreb.

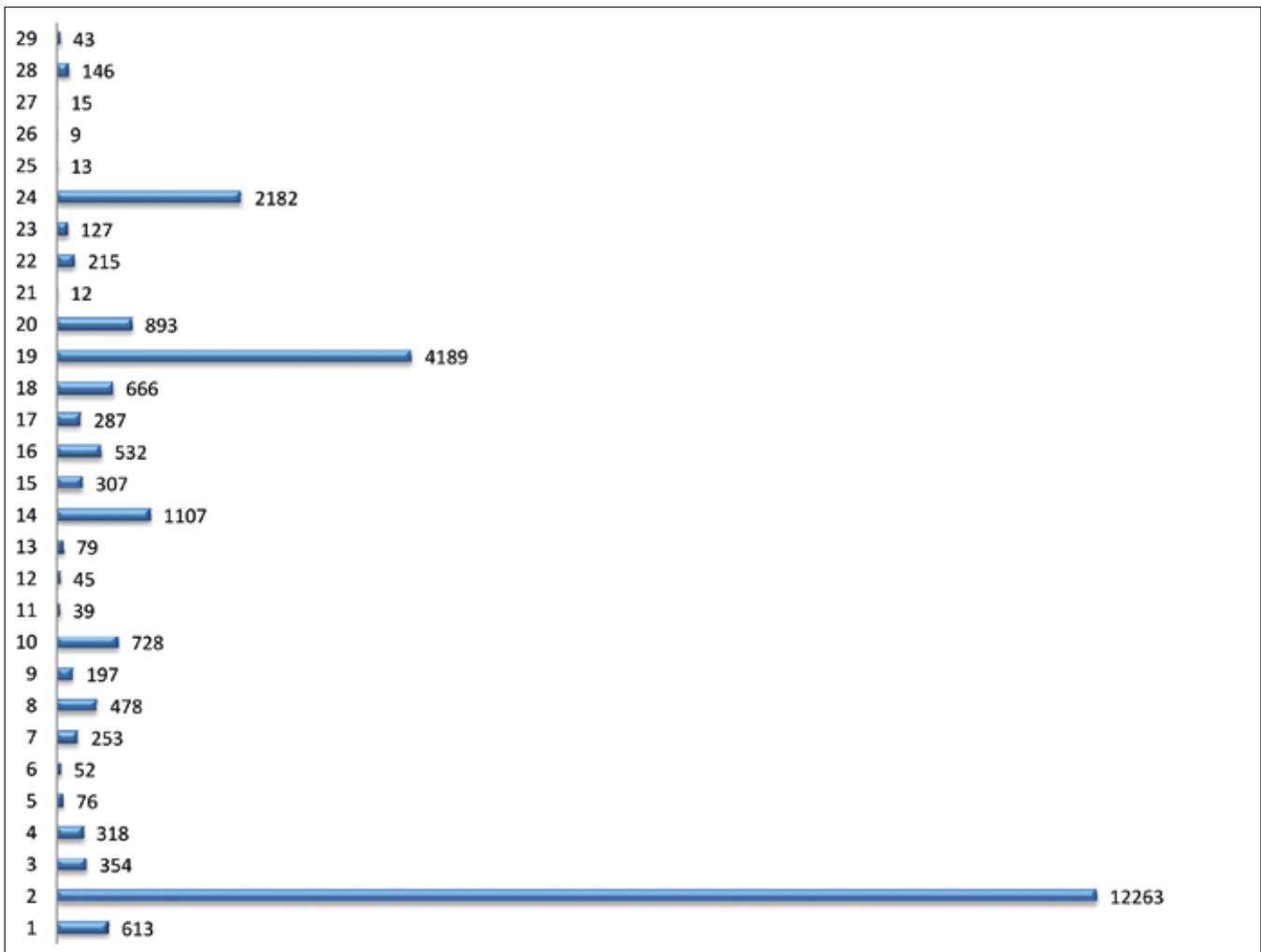

Grafikon 1 Zastupljenost struktura u gramima  
Graph 1 Presence of fabrics in grams



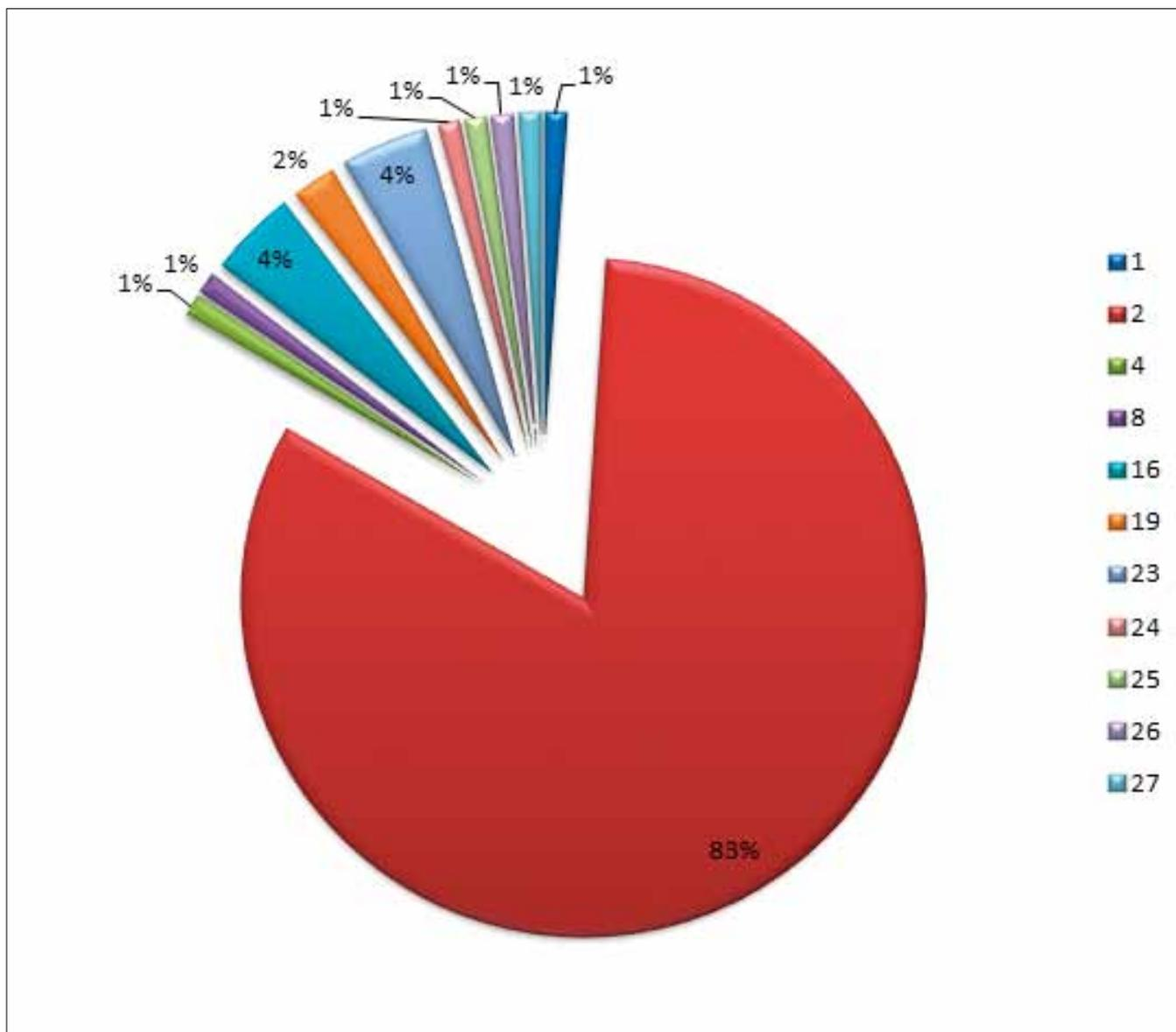

Grafikon 2 Grafički prikaz struktura u postotcima  
Graph 2 Graphic of fabrics in percentage

suda (Rye 1988: 31).

Na Virovitici Kiškoriji jug prevladava lokalno izrađena uporabna keramika. Rijetki su primjerci posuđa stolne keramike. Kako se radi o ruralnoj sredini, za očekivati je da je ona i sve u njoj prožeto prapovijesnim tradicijama. Nedostatak stolnog posuđa, karakterističnih keramičkih predmeta za rimsku antiku, (odsutnost uljanica i amfora, rijetki tarionici) također upućuju na jaku prapovijesnu tradiciju. To se zaključuje zato što se keramika za kuhanje i pripremu hrane počela razlikovati od one stolne keramike netom prije dolaska rimske vlasti, a samim dolaskom Rimljana i njihovih običaja, ta se razlika naglasila (Cool 2006: 53).

Više uzoraka zemlje s lokaliteta analizirano je, te je ustanovljena povećana kiselost tla. To je vjerojatno glavni uzrok loše očuvanosti, ne samo keramike nego i ostalih nalaza, naročito organskih.<sup>2</sup> Tu pretpostavku podupire i činjenica

2 Ph analize tla je izradila dr. sc. Z. Sedlar s odsjeka za Biologiju, Prirodoslovno-matematičkog fakulteta u Zagrebu.

sible to differentiate the vessels as those in which liquids were stored and served and those in which only solid food was kept, since the slip is mostly preserved only in traces. Interestingly, pottery from Orešac with fabric O 2, which is technologically identical to fabric VKJ 2 from *Virovitica Kišorija south*, is much better preserved.

### Description of the ceramic fabrics from Virovitica Kiškorija south site (Tables 2–3)

**1** Dark gray to black fired ceramics, coarse and very rough to the touch. The surface shimmers due to added sand and mica. Very large inclusions of quartz and irregular voids are clearly visible in the cross-section.

Presence in the catalogue: 28, 30, 51; context: first half of the 4<sup>th</sup> century; hardness: 2.<sup>3</sup>

3 In hardness defining the following criteria were used: 1: it can be incised with a fingernail; 2: it cannot be incised with a fingernail but with a knife it can, 3: it cannot be incised with a knife.

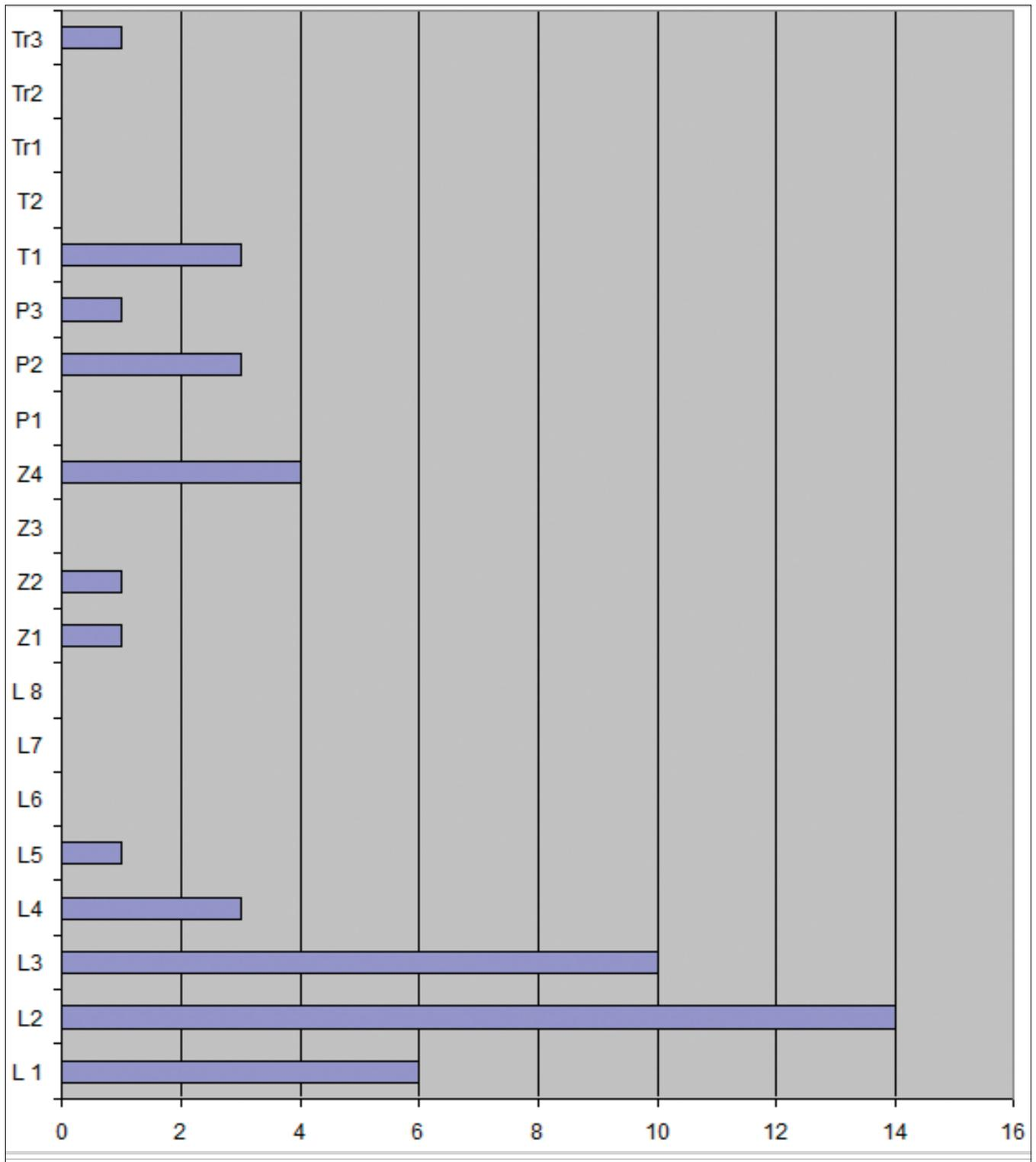

Grafikon 3 Zastupljenost tipova posuda

Graph 3 Presence of vessel types

što je kvalitetna keramika kao npr. sigilata također loše očuvana i otire se. S obzirom na stanje sačuvanosti premaza, smatram da je nemoguće govoriti o podjeli posuda na one u kojima se čuvala i servirala tekućina i na one u kojima se čuvala isključivo kruta hrana budući je premaz uglavnom očuvan samo u tragovima. Zanimljivo je što keramika iz Orešča strukture O 2, koja je tehnološki istovjet-

2 The predominant ceramic fabric (83%). Different firing colours may be seen on a single vessel. Ceramics have been crumbling, eroding; their surface is slightly shimmering due to sand inclusions. The most notable are inclusions in the form of short white lines (possibly their appearance was the result of temperature change, but without detailed geochemical analysis it is impossible to



na strukturi VKJ 2 s Virovitice Kiškorije jug znatno bolje očuvana.

### Opis struktura keramike s lokaliteta Virovitica Kiškorija jug (tablice 2–3)

**1.** Tamnosivo do crno pečena keramika, gruba i vrlo hrapava na dodir. Površina svjetluca zbog pijeska i tinjca. U presjeku su jasno vidljive vrlo krupne primjese kvarca i nepravilne šupljine.

Zastupljenost u katalogu: 28, 30, 51; kontekst: 1. polovina 4. st. po. Kr.; tvrdoća: 2.<sup>3</sup>

**2.** Struktura keramike koja je najviše zastupljena (83%). Može imati različite boje pečenja na samo jednoj posudi. Keramika se mrvi, otire se jako, površina je malo svjetlucava zbog primjesa pijeska. Najuočljivije su primjese u obliku kratkih bijelih linija (moguće da je zbog temperature došlo do ovakvog izgleda tih primjesa, ali bez detaljnih geokemijskih analiza nemoguće je utvrditi o čemu se radi). Ponekad se na površini nalazi premaz koji je slabo očuvan. U presjeku nisu uočene primjese kvarca i tinjca, a uočavaju se izdužene šupljine u presjeku koje mogu biti ostatci biljnog porijekla.

Zastupljenost u katalogu: 1, 2, 4–9, 11, 14–20, 24–27, 29, 31–42, 48–50, 53–58, 61–64, 66, 67, 69–84, 86–92, 101–104, 106–107, 109, 110–117, 122–125, 127–130, 132–135, 150, 154, 155, 158, 160–163, 177–180, 182, 184, 186, 187, 192–207, 210, 212, 218, 219, 221–227, 230; kontekst: od 2. do prve polovine 5. st., tvrdoća: 1.

**3.** Sivo pečena keramika čija se površina svjetluca zbog primjesa pijeska i usitnjenog kvarca. Površina je hrapava na dodir.

Struktura nije zastupljena u katalogu, kontekst: nije moguće datirati, tvrdoća: 1.

**4.** Sivo pečena keramika, glatke površine, tanka, izrađena na brzom kolu, površina se svjetluca zbog primjesa pijeska.

Zastupljenost u katalogu: 98, 99, 149, 175, 231 kontekst: 3. i 4. st., tvrdoća: 1.

**5.** Tamnosivo pečena keramika, u presjeku crvene boje, izrađena na kolu, površina svjetluca zbog primjesa pijeska, glatka je na dodir.

Zastupljenost u katalogu: 45, kontekst: prva polovica 3. st. Kr., tvrdoća: 2.

**6.** Keramika narančaste boje pečenja sa sivim presjekom, izrađena na brzom kolu, površina svjetluca zbog pijeska.

Nije zastupljena u katalogu, kontekst: prva polovica 3. st. po. Kr., tvrdoća: 1.

**7.** Keramika sivo pečene boje, površina svjetluca zbog pijeska, jako su vidljivi tragovi kola. Unutrašnja stijenka je hrapava, vanjska nije.

Zastupljenost u katalogu: 143, 144, 147, kontekst: prva polovina 3. st., tvrdoća: 1.

**8.** Sivo pečena keramika, malo mekša (po tvrdoći

define their origin). Sometimes poorly preserved slip can be seen on the surface. Inclusions of quartz and mica were not observed in the cross-section, but the elongated voids in the cross section were noticed, which could be the residues of vegetable origin.

Presence in the catalogue: 1, 2, 4–9, 11, 14–20, 24–27, 29, 31–42, 48–50, 53–58, 61–64, 66, 67, 69–84, 86–92, 101–104, 106–107, 109, 110–117, 122–125, 127–130, 132–135, 150, 154, 155, 158, 160–163, 177–180, 182, 184, 186, 187, 192–207, 210, 212, 218, 219, 221–227, 230; context: 2<sup>nd</sup>–1<sup>st</sup> half of the 5<sup>th</sup> century; hardness: 1.

**3** Gray fired ceramics with a surface shimmering due to added sand and crushed quartz. The surface is rough to the touch.

The fabric is not represented in the catalogue; context: dating is not possible; hardness: 1.

**4** Gray fired ceramic, smooth surface, thin, made on a fast wheel, the surface shimmering due to added sand.

Presence in the catalogue: 98, 99, 149, 175, 231; context: 3<sup>rd</sup> and 4<sup>th</sup> century; hardness: 1.

**5** Dark gray baked ceramic, red cross-section, made on a wheel; the surface is shimmering due to added sand; it is smooth to the touch.

Presence in the catalogue: 45; context: the first half of the 3<sup>rd</sup> century; hardness: 2.

**6** Orange fired ceramic having gray cross-section, made on a fast wheel; the surface is shimmering due to added sand.

Not represented in the catalogue; context: the first half of the 3<sup>rd</sup> century; hardness: 1.

**7** Gray fired ceramic; the surface is shimmering due to added sand, traces of the wheel are very visible. The inside surface is coarse, but the outside is not.

Presence in the catalogue: 143, 144, 147; context: first half of the 3<sup>rd</sup> century; hardness: 1.

**8** Gray fired ceramic, somewhat softer (hardness between fabrics 4 and 7), a shimmering surface due to added sand. Mostly, handles of jugs with a wide rim were made of this fabric. However, no fragments have been found that would allow the reconstruction of at least the upper part of those vessels.

Presence in the catalogue: 142, 145, 146, 159, 188; context: the first half of the 3<sup>rd</sup> century–4<sup>th</sup> century; hardness: 1

**9** Orange fired ceramic with thin walls (not as thin walled pottery!). The surface is shimmering due to added sand; inclusions of crushed ceramics are also visible. The surface is very erosive. Vessels were made on the wheel.

Presence in the catalogue: 44, 189; context: the 1<sup>st</sup> half of the 3<sup>rd</sup> century–4<sup>th</sup> century; hardness: 1.

**10** Similar to fabric 2, but there are no inclusions in the form of short and thin lines which are most characteristic of fabric 2. The surface of fabric 10 is more shimmering, containing more sand. Vessels were made on a wheel. It has black to gray firing colour, it does not have rough surface.

3 Za tvrdoću su korištena slijedeća mjerila: 1: noktom se može zarezati; 2. ne može se noktom ali može nožem, 3. ne može se nožem.

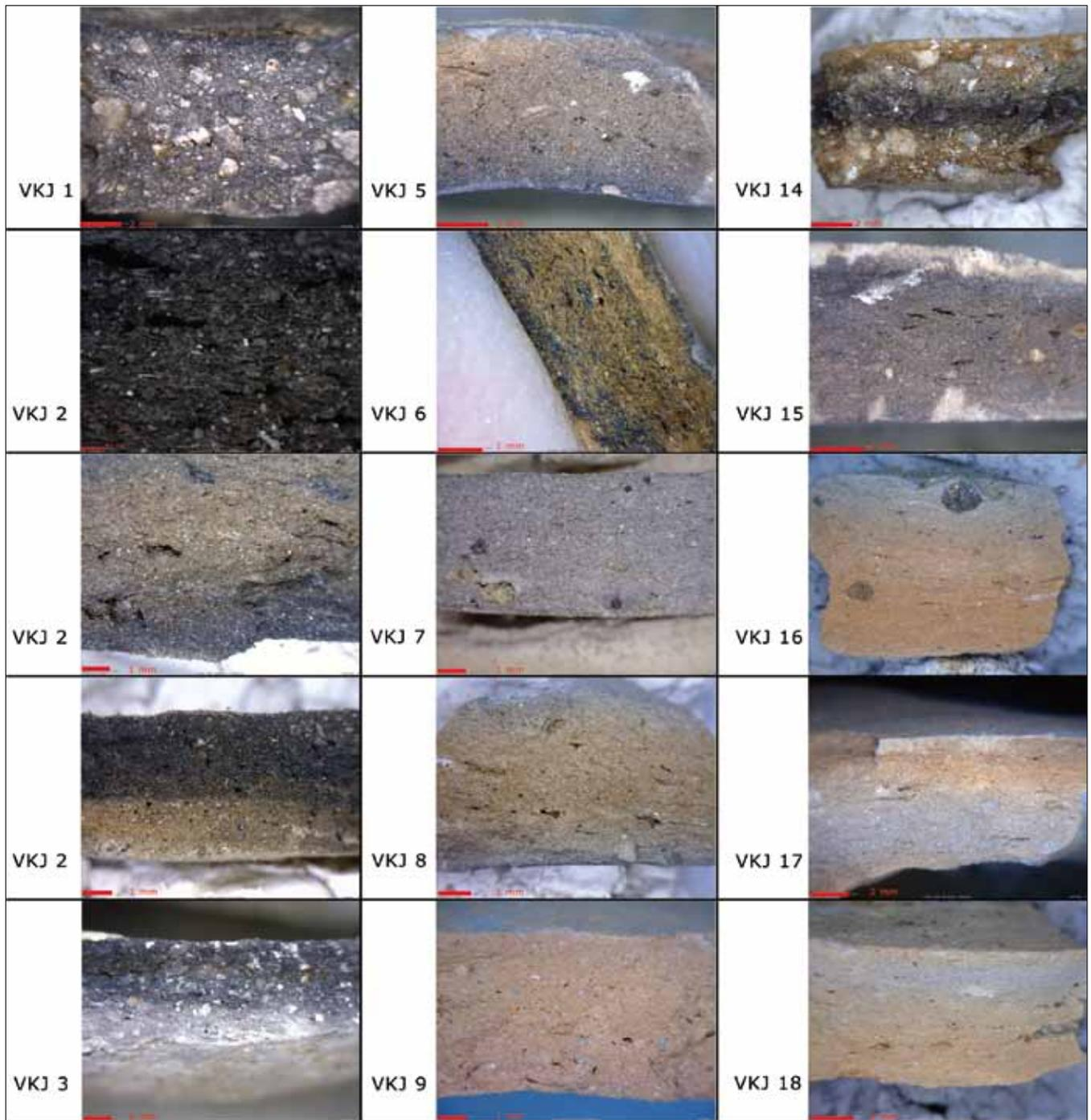

Tablica 2 Strukture keramike 1–19  
Table 2 Ceramic fabrics 1–19

između struktura 4 i 7), svjetlacava površina zbog pijeska. Od ove strukture izrađene su uglavnom drške koje su vjerojatno pripadale vrčevima širokog oboda. Ipak, nisu pronađeni takvi ulomci koji bi omogućili rekonstrukciju barem gornjeg dijela tih posuda.

Zastupljenost u katalogu: 142, 145, 146, 159, 188; kontekst: prva polovina 3. stoljeća, 4. st. tvrdoća: 1.

**9.** Narančasto pečena keramika, tankih stijenki (ne kao vrsta keramike!). Ima svjetlacavu površinu zbog primjese pijeska, a prisutne su i primjese mrvljene keramike. Površina se jako otire, a posude su izrađene na kolu.

Presence in the catalog: 136; context: first half of the third century. Hardness: 2.

**11** The surface of the ceramic is rough, the colour of firing is gray, brown in the cross section. The surface is shimmering due to added sand, and it has larger inclusions of quartz.

Presence in the catalogue: 22, 141; context: the first half of the 3<sup>rd</sup> century; hardness: 1.

**12** The ceramics having red and black fired walls. The surface is shimmering due to added sand and it is rough. Coarser and finer inclusions of sand and quartz are visible



Zastupljenost u katalogu: 44, 189 kontekst: prva polovina 3.–4. st., tvrdoća: 1.

**10.** Slična strukturi 2, ali nema primjesa u obliku kratkih i tankih crtica što je najkarakterističnije za strukturu 2. Površina strukture 10 više se svjetluca, odnosno ima više pijeska, izrađena je na kolu. Crno je do sive boje pečenja i nema hrapavu površinu.

Zastupljenost u katalogu: 136, kontekst: prva polovina 3. st., tvrdoća: 2.

**11.** Površina keramike je hrapava, sive je boje pečenja, dok je u sredini smeđa. Površina je svjetlacava zbog pijeska, a ima i većih primjesa kvarca.

Zastupljenost u katalogu: 22, 141, kontekst: prva polovina 3. stoljeća, tvrdoća: 1.

**12.** Keramika čije su stijenke crveno i crno pečene. Površina je svjetlacava zbog pijeska te je hrapava. U presjeku vidljive su krupnije i sitnije primjese pijeska i kvarca.

Nije zastupljena u katalogu, kontekst: prva polovina 3. stoljeća, tvrdoća: 1.

**13.** Narančasto do oker pečena keramika, glatka je na dodir i otire se. Svjetluca se na površini zbog primjesa pijeska.

Zastupljenost u katalogu: 13, 23, 43, 59, 60, 100, 137–139, 151, 153, 167, 190, 214, 228 kontekst: prva polovina 3.–4. st., prva polovina 5. st. tvrdoća: 1.

**14.** Nalikuje strukturi 1, ali je manje sjajna od nje. Jako je hrapava na dodir, ima krupne primjese mliječno bijele boje (kvarc), svjetluca se zbog primjesa tinjca i pijeska. Primjese su različite veličine. Boja pečenja varira od različitih tonova smeđe do sive i na ulomcima iste posude.

Zastupljenost u katalogu: 85, kontekst: 3.–4. stoljeće, tvrdoća: 2.

**15.** Smeđe pečena struktura. Površina je glatka i šupljikava (zbog ostataka biljnog porijekla). Izrađena je rukom, površina je svjetlacava zbog pijeska.

Zastupljenost u katalogu: 131, 171, kontekst: prva polovina 3. stoljeća, tvrdoća: 1.

**16.** Struktura koja nalikuje strukturi 21, narančasto je pečene boje s primjesama mrvljene keramike. Površina je glatka, malo svjetluca zbog primjesa pijeska i otire se. U presjeku se uočavaju nepravilne pukotine, možda ostatak primjesa koje su pečenjem izgorile.

Zastupljenost u katalogu: 10, 93, 95, 96, 118, 119, 152, 165, 168 kontekst: 3.–4. stoljeće i početak 5. stoljeća, tvrdoća: 1.

**17.** Crveno pečena struktura keramike s (vanjske i unutrašnje strane posude), a u sredini je sivo pečene boje. Ima primjesa mrvljene keramike i vrlo usitnjenog kvarca. Površina svjetluca zbog primjesa pijeska.

Zastupljenost u katalogu: 94, 97; kontekst 3.–4. stoljeće, tvrdoća: 1.

**18.** Narančasto pečena keramika, s primjesama smeđe i sive boje (mrvljena keramika ili oksidi?), dok je u sredini sive i narančaste boje. Površina je glatka i svjetluca zbog primjesa pijeska.

Nije zastupljena u katalogu, Kontekst: 2.–3. stoljeće, tvrdoća: 1.

in the cross-section.

Not represented in the catalogue; context: the first half of the 3<sup>rd</sup> century; hardness: 1.

**13** Orange to ochre fired ceramic, smooth to the touch and eroding. The surface is shimmering due to added sand.

Presence in the catalogue: 13, 23, 43, 59, 60, 100, 137–139, 151, 153, 167, 190, 214, 228; context: the 1<sup>st</sup> half of the 3<sup>rd</sup> century–1<sup>st</sup> half of the 5<sup>th</sup> century; hardness: 1.

**14** Resembles fabric 1, but it is less glossy. It is rough to the touch, it has large milky white inclusions (quartz), it is shimmering due to inclusions of mica and sand. Inclusions are different in measure. Firing colour ranges from various shades of brown to gray, also on fragments of the same vessel.

Presence in the catalogue: 85; context: 3<sup>rd</sup>–4<sup>th</sup> century; hardness: 2.

**15** Brown fired fabric. The surface is smooth and porous (due to residues of plant origin). Made by hand; the surface is shimmering due to added sand.

Presence in the catalogue: 131, 171; context: the first half of the 3<sup>rd</sup> century; hardness: 1.

**16** Fabric which resembles fabric 21; orange firing colour with inclusions of crushed pottery. The surface is smooth, slightly shimmering due to added sand, eroding. Irregular cracks visible in the cross-section, possibly residue of impurities burnt during firing.

Presence in the catalogue: 10, 93, 95, 96, 118, 119, 152, 165, 168; context: 3<sup>rd</sup>–early 5<sup>th</sup> century; hardness: 1.

**17** Red fired ceramic fabric on the inside and outside of the vessel, and gray coloured in cross-section. It contains inclusions of crushed pottery and highly fragmented quartz. The surface is shimmering due to added sand.

Presence in the catalogue: 94, 97; context 3<sup>rd</sup>–4<sup>th</sup> century; hardness: 1.

**18** Orange fired ceramic, with a touch of brown and gray (triturated ceramics or oxides?), gray and orange in the cross-section. The surface is smooth and shimmering due to added sand.

Not represented in the catalogue; context: 2<sup>nd</sup>–3<sup>rd</sup> century; hardness: 1.

**19** Resembles fabric 2, but it has irregular voids at the surface and in the cross section, probably due to the presence of limestone. Inclusions of triturated ceramics are visible in the cross-section and on the surface. The surface shimmers due to added sand and it is gray. The surface is not rough, but it is not very smooth either.

Presence in the catalogue: 172, 209, 211; context: 2<sup>nd</sup>–3<sup>rd</sup> century; hardness: 1.

**22** It resembles fabrics 19 and 2. The surface and the cross-section have no voids, which makes it different from fabric 19. It differs from fabric 2 by inclusions of triturated ceramics. Ceramic material of this fabric is made on a wheel. The surface shimmers due to added sand, and there is a

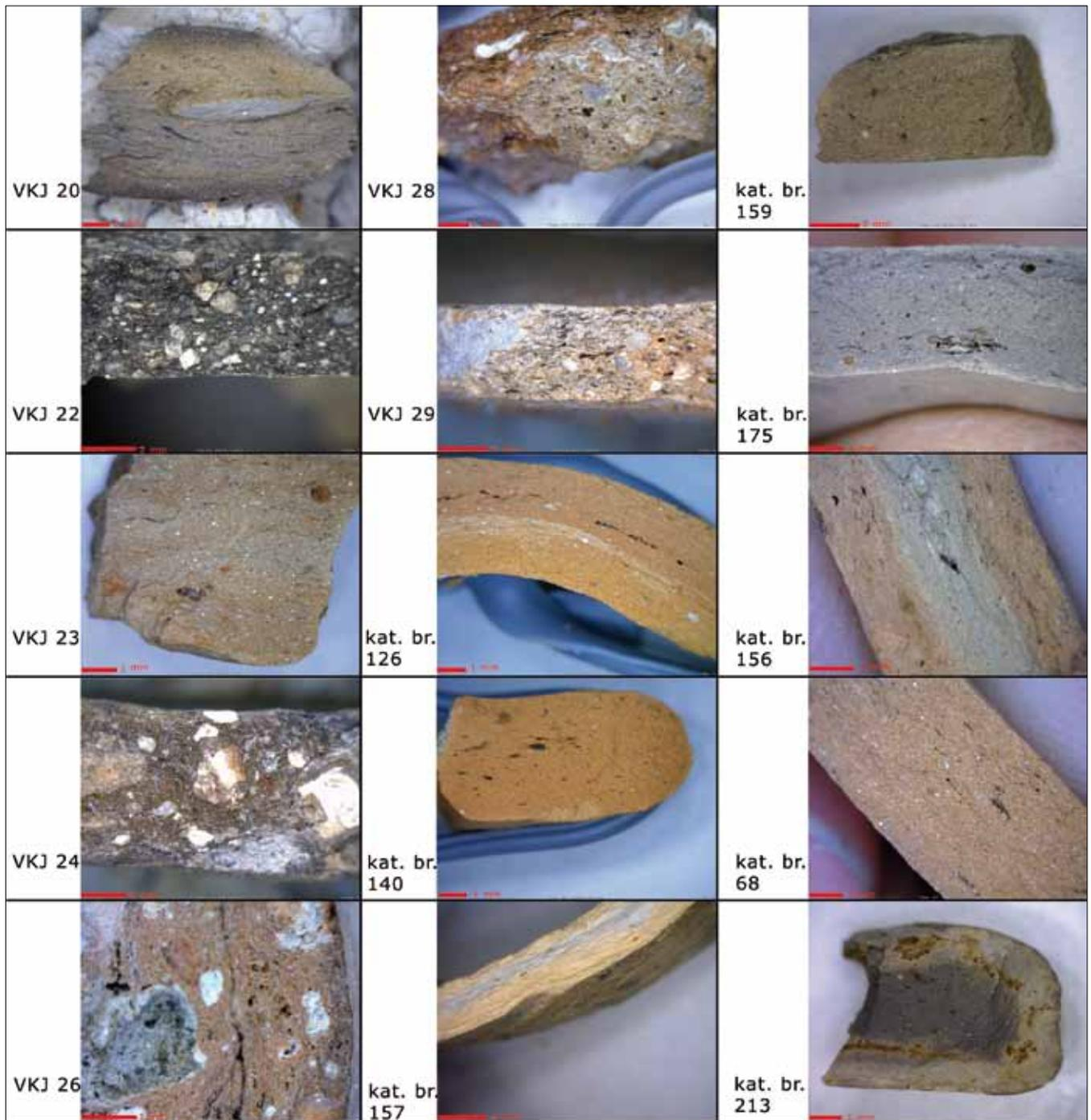

Tablica 3 Strukture keramike 20–29 i kat. brojeva 126,140, 157, 159, 175, 156, 68, 213  
 Table 3 Ceramic fabrics 20–29 and Cat. Numbers 126, 140, 157, 159, 175, 156, 68, 213

**19.** Sliči strukturi 2, ali na površini i u presjeku ima šupljine nepravilnog oblika, vjerojatno zbog vapnenca. U presjeku i na površini vidljive su i primjese mrvljene keramike, površina svjetluca zbog primjesa pijeska. Sive je boje. Površina nije hrapava, ali nije ni jako glatka.

Zastupljenost u katalogu: 172, 209, 211; kontekst: 2.–3. stoljeće, tvrdoća: 1.

**20.** Nalikuje strukturama 19 i 2. Ono što je razlikuje od strukture 19 jest to što površina i presjek nemaju šupljine, a

discrete vertical decoration. Firing colour is cream.

Not represented in the catalogue, context: 2<sup>nd</sup>–3<sup>rd</sup> century; hardness: 1.

**21** Grey fired fabric with a black slip on the outer and inner walls; surface is smooth, not shimmering.

Presence in the catalogue: 213; context: 2<sup>nd</sup>–3<sup>rd</sup> century; hardness: 1.

**22** Black fired (on the inside, on the outside and in the cross-section) ceramics rough to the touch. The surface



od strukture 2 razlikuje je to što u sebi ima primjese mrvljene keramike, a keramički materijal ove strukture izrađen je na kolu. Površina svjetluca zbog pijeska, a na njoj se nalazi diskretni okomiti ukras. Krem boje je pečenja.

Nije zastupljena u katalogu, kontekst: 2.-3. stoljeće, tvrdoća: 1.

**21.** Sivo pečena struktura s crnim premazom na vanjskoj i unutrašnjoj stijenci, glatke površine koja ne svjetluca.

Zastupljenost u katalogu: 213, kontekst: 2.-3. stoljeće, tvrdoća: 1.

**22.** Crno pečena (unutra, van i u presjeku) keramika koja je hrapava na dodir. Površina svjetluca zbog primjesa pijeska i vrlo usitnjenog kvarca. Na površini i presjeku mjestimice se javljaju nepravilne i pravocrtne šupljine (ostaci vapnenca i trave). Izrađena je na kolu.

Zastupljenost u katalogu: 65?, 164 kontekst: Prva polovina 5. stoljeća, tvrdoća: 2.

**23.** Crveno pečena keramika čija površina sjaji zbog dodatka pijeska. Na dodir je glatka, ima primjese mrvljene keramike i crveni premaz na površini.

Zastupljenost u katalogu: 46, 170, 174, 181, 185; kontekst: prva polovina 3. st.– 4. st., tvrdoća: 1.

**24.** Struktura gotovo metalnog sjaja. U presjeku i na površini vide se vrlo krupne primjese kvarca i tinjca: Nalikuje strukturama 1, 14 i 28. Boja pečenja je od različitih tonova smeđe do tamno sive i na istoj posudi.

Zastupljenost u katalogu: 52, 183, 215, kontekst: 3.–4. st.; tvrdoća: 2.

**25.** Crno pečena keramika s primjesama kvarca i hrapavom površinom.

Zastupljenost u katalogu: 220, kontekst: nije moguće datirati; tvrdoća: 2.

**26.** Smeđe do crveno pečena keramika hrapave površine. Ima sitne primjese kvarca, u presjeku i na površini vidljive su nepravilne pukotine kao posljedica gorenja organskih tvari i vapnenca.

Zastupljenost u katalogu: 176, kontekst: ? tvrdoća: 1.

**27.** Crveno pečena keramika s crnim premazom. U presjeku se vide sitne šupljine, a u strukturi ima primjesa pijeska.

Zastupljenost u katalogu: 169, kontekst: ?, tvrdoća: 1.

**28.** Struktura s puno krupnih primjesa, površina jako svjetluca zbog velike količine tinjca bijele i crne boje, te pijeska. U presjeku se vide krupne primjese kvarca i rupe od izborne trave. Podsjeća na strukture 1, 14 i 24.

Zastupljenost u katalogu: 216, kontekst: 3.–4. stoljeće, tvrdoća: 2.

**29.** Crvene boja pečenja, a površina keramike ima metalni žućkasti sjaj zbog velike količine tinjca. U strukturi se nalaze i krupne primjese kvarca. Površina je vrlo gruba i hrapava, te ima šupljina na površini i u presjeku.

Zastupljenost u katalogu: 12, kontekst: 3.–4. st., tvrdoća: 2.

shimmers due to additions of sand and crushed quartz. Irregular linear voids appear sporadically (remnants of limestone and grass) on the surface and in the cross-section. This ceramics was made on a wheel.

Presence in the catalogue: 65 (?), 164; context: the first half of the 5<sup>th</sup> century; hardness: 2.

**23** Red fired ceramic the surface of which shimmers due to added sand. Smooth on the touch, showing inclusions of crushed ceramics and red slip on the surface.

Presence in the catalogue: 46, 170, 174, 181, 185; context: the first half of the 3<sup>rd</sup> century–4<sup>th</sup> century; hardness: 1.

**24** Fabric showing almost metallic glow. Very large inclusions of quartz and mica visible in the cross-section and on the surface: resembles fabrics 1, 14 and 28. Firing colour of different tones of brown to dark gray may be seen on the same vessel.

Presence in the catalogue: 52, 183, 215; context 3<sup>rd</sup>–4<sup>th</sup> century; hardness: 2.

**25** Black fired ceramic with inclusions of quartz and a having rough surface.

Presence in the catalogue: 220; context: dating impossible; hardness: 2.

**26** Brown to red fired ceramic with rough surface. It has small inclusions of quartz and irregular cracks as a result of burning of organic matter and limestone, visible in the cross-section and on the surface.

Presence in the catalogue: 176; context: (?); hardness: 1.

**27** Red fired ceramic with black slip. Small voids are visible in the cross-section, inclusions of sand present in the fabric.

Presence in the catalogue: 169; context: (?); hardness: 1.

**28** Fabric with a lot of large inclusions; surface shimmering due to large amounts of white and black mica and sand. Large inclusions of quartz and voids from the burned grass are visible in the cross-section. This fabric resembles fabrics 1, 14 and 24.

Presence in the catalogue: 216; context: 3<sup>rd</sup>–4<sup>th</sup> century; hardness: 2.

**29** Red firing colour; the surface of the ceramic shows a metal yellowish glow due to large amounts of mica. Within the structure large quantities of quartz were found. The surface is very coarse and rough. On the surface and in the cross section voids may be seen.

Presence in the catalogue: 12; context: 3<sup>rd</sup>–4<sup>th</sup> century; hardness: 2.

## Uporabna keramika lokalne proizvodnje: definicija, problematika proizvodnje i rasprostiranje

### *The locally produced functional ceramics: definition, issues related to production, and distribution*

Keramika korištena za pripremanje, kuhanje, čuvanje i serviranje hrane, često je, ali ne i uvijek, izrađena od grublje strukture, ponekad s premazom koji nije visokog sjaja i kvalitete. Proizvedena je unutar mikroregije i namijenjena distribuciji isključivo unutar te mikroregije, te se naziva *uporabna keramika lokalne proizvodnje*.

S obzirom na proizvodnju i područje rasprostranjenosti keramičkih proizvoda u literaturi i praksi razlikuju se tri osnovne vrste tog posuđa:

- proizvodnja posuđa u velikim gradskim i prigradskim radionicama sa specijaliziranim obrtnicima koji su proizveli skupocjene keramičke proizvode i proizvode zahtjevne proizvodnje predviđene za masovnu upotrebu i prodaju, a koja se iz svog proizvodnog centra prodavala i do najudaljenijih dijelova Carstva. Ovakva proizvodnja naziva se *industrijskom* s obzirom na količinu proizvoda, organizaciju proizvodnje, specijalizaciju lončara i distribuciju keramičkih posuda,

- posuđe koje se proizvodilo u malenim gradskim, prigradskim ili seoskim radionicama i radionicama na rustičnim vilama. Obrtnici su izrađivali raznovrsno posuđe, odnosno nisu bili specijalizirani za proizvodnju samo jedne vrste. To se posuđe prodavalo i koristilo na području provincije u kojoj je proizvedeno, te se često naziva *provincijalna* keramika. Ona se ne mora nužno susretati unutar samo jedne provincije (na što pogrešno upućuje naziv), može se naći i u susjednim provincijama, odnosno na graničnim područjima, što uvijek ovisi o razvijenosti prometne mreže. Također, ovisno o vrsti keramike, njejoj kvaliteti i zahtjevima tržišta, ovisi i rasprostranjenost ove vrste keramike,

- postojao je dio tržišta, proizvodnje, prodaje i korištenja onog posuđa koju su proizvodili pojedinačni lončari koji se time nisu morali baviti cijelo vrijeme, već po potrebi. Proizvodili su uporabnu keramiku koja se svakodnevno koristila, a prodavala se na lokalnom tržištu. Ovu keramiku tj. posuđe, mogao je proizvoditi i pojedinac za potrebe vlastitog kućanstva ili za potrebe imanja (Vikić-Belančić 1968a: 509; Pollard 1988: 181–190; Peña 2007: 32). To je keramika *lokalne* proizvodnje.

Proizvodnja posuđa za potrebe rustičnih vila na njima je dokazana i iskopavanjima, ali je i logična s obzirom na to da se na vilama nastojalo proizvesti sve ono što je njenim stanovnicima bilo potrebno, kako bi imanje bilo što više samodostatno, što uključuje postojanje različitih obrtni-

The ceramics used for preparation, cooking and serving of food is often, but not always, made from coarser fabric, sometimes with a slip that is not of high gloss or high quality. They are produced within a micro region, aimed at distribution exclusively within the micro region and they are called *locally produced functional ceramics*.

Three basic sorts of pottery can be differed in literature and practice with regard to production of ceramic products and the range of their distribution:

- production of pottery in bigger urban and suburban workshops with specialized craftsmen who produced expensive ceramic products and high-end products intended for mass consumption and sale, that was sold, from the centre of production all across the Empire. This kind of production, relating to the quantity of products, organization of production, specialization of potters and distribution of ceramic products, is called *industrial*,

- pottery produced in small city, suburban or rural workshops and villa rustica workshops. Craftsmen produced various types of pottery, i.e. they were not specialized in producing just one kind. This pottery was sold and used in the area of the province in which it had been produced and it is often called *provincial* pottery. It is not necessarily found just in one province (as the title wrongly suggests), it can also be found in neighbouring provinces and bordering territories, depending on the development of the transportation network. In addition, the distribution of this kind of pottery depends on the sort and quality of the pottery as well as market demands,

- there was a segment of market, production, sale and use of the pottery produced by individual potters, who did not have to produce all the time, just when needed. They produced functional ceramics that were used on daily basis and sold on local markets. These ceramics, i.e. pottery, could be produced by an individual for his household needs or estate needs (Vikić-Belančić 1968a: 509; Pollard 1988: 181–190; Peña 2007: 32). That is *locally* produced pottery.

The production of pottery for villae rusticae needs is proven on them by excavations, and it is also logical in view of the effort taken to produce everything necessary for villa's inhabitants, so that the estate could be more self-sufficient, which includes the existence of different craftsmen in villas, including the production of pottery (Sanader 1995: 98–99; Peacock 1997: 161–169).



ka na vilama, a time i proizvodnju posuđa (Sanader 1995: 98–99; Peacock 1997: 161–169).

Za potpunije razumijevanje, bitno je da se na početku razjasni problematika uporabne keramike lokalne proizvodnje, barem što se tiče njenih dosadašnjih saznanja, a problematika se odnosi na proizvodnju, distribuciju, korištenje, korisnike, trajanje i razvoj.

Velika političko-ekonomska zbivanja nužno su se odražavala na trgovinu, pa tako i trgovinu keramikom (Vikić-Belančić 1968a: 509). Ipak, odražavala se u mnogo manjoj mjeri na trgovinu i proizvodnju keramike lokalne proizvodnje čija se distribucija odnosi na malena područja, zbog toga što je potražnja za takvom robom uvjetovana potrebom za svakodnevnu pripremu hrane, a ne potrebom za skupocjenim posuđem zbog čega se trgovalo na velike udaljenosti. Posjedovanje keramike za kuhanje, spremanje, serviranje (ukoliko se radi o lokalnoj keramici) i čuvanje je nužnost, a ne stvar statusa i to je razlog zbog kojeg ona ne ovisi o ekonomskoj moći pojedinca i ekonomsko političkim zbivanjima.

Podravina, gdje je smješten lokalitet Virovitica Kiškorija jug, čiji se keramički materijal ovdje analizira, dobro je povezana sa svim većim proizvodnim središtima Panonije koja su mogla nametnuti svoje proizvode, modu i ukus. Prije svega, to su *Siscia*, *Poetovio*, *Mursa* i *Cibalae*. Ipak, što se tiče same lokalne proizvodnje uporabne keramike, utjecaj i imitacija tih centara su minimalni.

Količina prodavane keramike lokalne proizvodnje na samom lokalitetu ovisila je o svakodnevnim potrebama, odnosno o trošenju i razbijanju posuda – najelementarnijim potrebama i svakodnevним događajima, a ne o luksuzu koji je ujedno ovisio o bogatstvu, a time i ekonomskim i političkim zbivanjima. Zanimljiv je podatak kod Apicijevih recepata što za više recepata nalaže uzimanje novih posuda (Slapšak 1989: 16).

Uporabna keramika lokalne proizvodnje je prije svega morala zadovoljiti praktične i tehnološke uvjete, imati određena geokemijska svojstva kako bi izvršila svoju ulogu. To je bilo važno osobito za one posude koje su služile za kuhanje. Estetika i ukrašavanje za ovu vrstu keramike nisu bili prioritet.

S obzirom na potrebe pojedinih vrsta posuđa razlikujemo posuđe za kuhanje i podgrijavanje, pohranu tekućih i krutih sadržaja. Osobine posuda koje imaju jednu funkciju neće biti dobre za druge zadatke. Zbog toga je potrebno prilagoditi posudu njenoj ulozi ili proizvesti posudu koja će biti kompromisno rješenje i zadovoljiti sve uloge (Rye 1988: 26–27).

U literaturi se često spominju različiti pojmovi: gruba, kuhinjska, domaća keramika. Pod tim pojmovima misli se na keramiku, gore navedene treće grupe – uporabnu keramiku koja može biti i lokalne proizvodnje, a koja je često rađena rukom, samo nekad dorađivana na kolu, a dio posuda je u potpunosti izrađen na kolu. Glina je miješana s pijeskom, kvarcom, vapnencem i tinjcem u različitim omjerima i različitim granulacijama. Boja pečenja također je različita i to ne samo među različitim posudama već su i

To comprehend them better, it is important first to explain the problems concerning production, distribution, use, users, duration and development of locally produced functional ceramics.

Commerce, including the trade of ceramics was necessarily influenced by important events in politics and economics (Vikić-Belančić 1968a: 509). However, it did not significantly influence the trade and production of locally manufactured ceramics which were distributed in smaller areas, because the demand for this kind of goods was conditioned by the need for everyday meal preparation and not the need for expensive ceramics that was traded in larger areas. It is not a matter of prestige, but a necessity to possess ceramics for cooking, preparing, serving (if it concerns locally produced ceramics) and food preservation, therefore it is not affected by purchasing capacity per capita or economic and political events.

Podravina, the region where the site Virovitica Kiškorija south is located and whose ceramic material is analysed here, is well connected with all larger centres of production that could easily impose their products, taste and style. Foremost those are *Siscia*, *Poetovio*, *Mursa* and *Cibalae*. Nevertheless, the influence and the imitation on locally produced functional ceramics are minimal.

The amount of locally produced ceramics sold on a site depended on everyday needs, pottery scuffing and breaking – the most basic needs and everyday events, not luxury that in itself depended on wealth as well as economic and political events. It is interesting that several recipes from Apicius require the use of a new pot (Slapšak 1989: 16).

The locally produced functional ceramics primarily had to meet the practical and technological conditions and have certain geochemical characteristics in order to perform its role. This was especially important for cooking pots. The aesthetics and decoration were not a priority for this type of ceramics.

Regarding the needs of particular types of pottery we can distinguish pottery for cooking, reheating, preservation of liquid and solid content. Characteristics of one type of pottery are not adequate for other uses. Consequently, it is necessary to adjust the pot for its usage or produce one that will achieve a satisfactory solution to all purposes (Rye 1988: 26–27).

We can often find different terms in literature: crude, kitchen, domestic ceramics. The ceramics under these terms are considered to be the ceramics of the third type, mentioned above – functional ceramics that can be locally produced, often made by hand, seldom remade on a wheel, with a part of the pot completely made on a pottery wheel. The clay is mixed in different proportions and different granulations with sand, quartz, limestone and mica. The firing colour is not only different among different pots but also within the same kind of pots (Mikl Curk 1973: 884), as a result of a large number of potters, level of their skills and diverse simple furnaces in which it was hard to control firing conditions. Also, these pots were not always fired in



same posude neujednačene boje (Mikl Curk 1973: 884), što je logično s obzirom na veliki broj lončara, stupanj njihove umještosti i različitim jednostavnim pećima u kojima je bilo teško kontrolirati uvjete pečenja. Također, te posude nisu uvijek pečene u pećima jednostavnog tipa, one su mogle biti pečene u iskopanim jamama ili na otvorenom, za tu svrhu napravljenom, ognjištu. U tim uvjetima postupak pečenja traje od 30 do 60 minuta (Peacock 1997: 25).

U naseljima u kojima postoji kontinuitet iz vremena mlađeg željeznog doba, nit vodilja pri proizvodnji uporabne keramike lokalne proizvodnje je tradicija. Prapovijesne tradicije su za očekivati i u lončarstvu budući da su one vidljive u političkoj, ekonomskoj, religijskoj i kulturnoj svakodnevnici. Istraživanja groblja, kultura i naselja pokazuju očuvanje i svojevrstnu renesansu latenskih obrtničkih vještina što se naročito očituje u lončarstvu (Gabler 1982: 57–128; 1990–1991: 51). Tamo gdje postoji kraći diskontinuitet u naseljavanju, lokalna tradicija je nešto manje prisutna. Također, jačina tradicije ovisi i o brojnosti stanovnika koje su tu Rimljani zatekli i jačini njihove organizacije prije dolaska Rimljana, vjernosti vlastitim tradicijama i volji da se prepuste novim običajima, ali i o volji i potrebi Rimljana da provedu svoje običaje (Gabler 1990–1991: 61–62). Na lokalitetima kao što su *Carnuntum*, *Brigetio*, *Wien-Unterlaa*, *Gorsium* javlja se rukom rađena keramika datirana od 1.–3. stoljeća koja se veže za lokalno stanovništvo i njegove tradicije koje se dugo zadržavaju (Gabler 1990–1991: 63).

Jednostavnost oblika važna je za proizvodnju, ali i za korištenje uporabne keramike lokalne proizvodnje. Lokalni majstori su poznavali osnove proizvodnje keramike i osobine materijala, što je bilo osnovno za dobivanje posuda za točno određenu namjenu. Ipak, često nisu raspolagali kvalitetnom sirovinom i odgovarajućim primjesama za poboljšanje strukture posuda, te su zbog toga njihova vještina i snalažljivost bile važne. Nedostajale su im i dobro izrađene keramičke peći u kojima su mogli kontrolirati uvjete pečenja. Sve je to utjecalo na postupak izrade ove vrste keramike, a to je, da je ona oblikovana na jednostavan način, od sirovine koja im je bila na raspolaganju, da su tijekom desetljeća i stoljeća primjenjivane iste tehnike pripreme sirovine, oblikovanja posuda i tretiranja njihovih površina, s vrlo malim promjenama u tehnološkom procesu i oblikovanju. Uporabna keramika koja je lokalno proizvedena, često je oblikovana rukom bez primjene kola, posebno ako se radi o proizvodima koje je izradio lončar u seoskim sredinama (rustične vile, sela). Uporabna keramika lokalne proizvodnje također je pečena u jednostavnim pećima, na otvorenoj vatri ili u jamama. Izgradnja složenih peći nije ni imala smisla, jer im se nije isplatila.

Kod uporabne keramike lokalne proizvodnje najčešći su latenski utjecaji (Vikić-Belančić 1967: 26), ipak, čak i na prostoru hrvatskog dijela rimske provincije Gornje Panonije, ne smije se generalizirati s takvim zaključcima. Uočavaju se razlike u keramičkom materijalu unutar spomenutog područja, točnije između pojedinih lokaliteta. Keramički materijal iz sjeverozapadnog dijela hrvatskog dijela Gornje Panonije, poznat je dijelom iz objava, a uporabna kera-

basic type kilns, they could be fired in the pits or on an open fire, made for that occasion. Under these conditions, the firing process lasts from 20 to 30 minutes (Peacock 1997: 25).

In the settlements that have continuity from the early Iron Age, in the production of locally manufactured functional ceramics the guiding idea is tradition. Prehistoric traditions are to be expected in pottery, since they are visible in everyday politics, economics, religion and culture. The renaissance and preservation of craftsmanship from the La Tène culture can be seen through the examination of graves, cults and settlements, especially on pottery (Gabler 1982: 57–128; 1990–1991: 51). The local tradition is less represented in places with short-period discontinuity of settlement. The power of tradition also depends on a number of inhabitants found there by the Romans and on the strength of their organisation before Romans' arrival, on their truthfulness to their own traditions and their willingness to accept new customs, as well as on the resolution and need of Romans to introduce their customs (Gabler 1990–1991: 61–62). Ceramics made by hand, dating from the 1<sup>st</sup> to the 3<sup>rd</sup> century, can be found on sites like *Carnuntum*, *Brigetio*, *Wien-Unterlaa*, *Gorsium*, and it is associated with local inhabitants and their traditions that are retained for a long time (Gabler 1990–1991: 63).

The simplicity of form is important for manufacture and use of locally produced functional ceramics. Local craftsmen knew the basics of ceramics production and material properties, which was sufficient to make pots for an exact purpose. Their skills and adaptability were important, since they would seldom have access to high quality raw materials and adequate inclusions to improve the structure of the pottery. They did not have well built ceramic kilns, in which they could control the firing conditions. All this influenced the process of manufacture of this type of ceramics, thus it is moulded in a simple way, from available raw materials, made by applying the same techniques of raw material preparation, pot moulding and surface treatment throughout the centuries, with very little changes in technological process and moulding. The functional ceramics that were locally produced, were often moulded by hand without the wheel, especially if they were made by a potter in rural areas (*villae rusticae*, villages). Locally produced functional ceramics were also fired in simple kilns, open fires or pits. It did not make sense to build complex kilns, because it was not profitable.

La Tène culture mostly influenced the locally produced functional ceramics (Vikić-Belančić 1967: 26), however, we should not draw generalized conclusions even in the Croatian part of the Roman province of Upper Pannonia. Differences in ceramic material can be noted in the area mentioned above, to be more accurate, among individual sites. The ceramic material from the northwestern part of Croatian part of Upper Pannonia is partly known from publications, whereas the functional ceramics from the north-eastern part of the province represent in a way a

mika iz sjeveroistočnog dijela te provincije predstavlja na neki način novost i tipološki se razlikuje od keramike iz zapadnog, ali i južnog dijela (Jelinčić 2009: 13–14). To se ne može objasniti slabom komunikacijom budući da su ta dva prostora bila vrlo dobro cestovno povezana, već jednostavno postojanjem različitih mikroregionalnih cjelina unutar kojih postoji različito tipološki oblikovana keramika za svakodnevnu upotrebu, koja je dakako izrađena od drukčije sirovine. Tu je keramiku ponekad i unutar iste mikroregije teško uspoređivati zbog činjenice što ona nije rezultat industrijske masovne unificirane proizvodnje. Ona je djelo niza brojnih lokalnih majstora koji su prije svega pojedinci, a ne obrtnici organiziranih radionica, tako da je svaka posuda na neki način unikatna, posebno ako se radi o posuđu koje je izrađeno rukom. Ono što razlikuje keramiku istočnog dijela Gornje Panonije (govori se i dalje o hrvatskom dijelu te provincije) od zapadnog je i nedostatak ukrasa na gruboj keramici u onom širokom repertoaru i zastupljenosti. Količina utjecaja prapovijesne tradicije ovisi o kontinuitetu prapovijesnog i rimskog naselja, odnosno o ukorijenjenosti prapovijesne lončarske (između ostalog) tradicije, o umješnosti novih lončara da prenesu i održe znanje.

Specifičnosti uporabne keramike lokalne proizvodnje vezane su uz određene mikroregije. Unutar pojedine regije mogu se primijetiti izvjesne specifičnosti kojih nema u tolikoj mjeri u drugom kraju. Unutar mikroregije, među samim lokalitetima opet postoje neke razlike, tj. dio uporabne keramike lokalne proizvodnje koji se može sresti isključivo na tom lokalitetu. To se odnosi na oblik, ukrase i tehnologiju. Poznavanju života u antici proučavanje keramike donosi mnogo, a proučavanje lokalno proizvedene keramike sa svim mikroregionalnim posebnostima važno je za poznavanje svakodnevnih navika u pojedinim područjima i za poznavanje različitosti između pojedinih regija. Intenzivna arheološka istraživanja posljednjih godina donijela su veliku količinu arheološkog materijala, a temeljita obrada cjelokupne keramičke građe omogućiti će da se mikroregije prepoznaju i zaokruže kao cjeline. Pretpostavlja se da su se mikroregije razvile oko nekog centra, (ne nužno kolonije ili municipija) uz pretpostavku postojanja razvijenih komunikacija te osnovnih sirovina (glina, voda, šume).<sup>1</sup> Ipak, svaki pregledani lokalitet unatoč blizini nekog centra ima i specifičan materijal koji se razlikuje od lokalne keramike tog centra.

Uporabna keramika lokalne proizvodnje zapravo je svakodnevno korištena i zbog toga se brzo trošila, izlagala termičkim šokovima, često se premještala, što znači da se često mijenjala i da je njezin životni vijek bio kratak – znatno kraći od vijeka trajanja stolne keramike koja se mogla koristiti duži niz godina. Nezgodno je jedino to, što ta uporabna lokalno proizvedena keramika dugo zadržava isti oblik, što ne pomaže previše pri datiranju ukoliko nemamo

novelty and are typologically different from the ceramics found in the western and southern part (Jelinčić 2009: 13–14). This cannot be explained by poor communication, since these parts were very well connected by roads, but by the existence of different micro regional units that have differently moulded ceramics in terms of typology. Sometimes it is hard to compare these ceramics within the same micro region, for they are not made in a mass industrial unified production. They are the work of numerous local craftsmen, who worked independently and not in organized workshops. That makes each pot in a way unique, particularly the pottery made by hand. The difference between the ceramics of the eastern and the western part of Upper Pannonia (the Croatian part of it) is in the absence of decoration on the coarse ceramics in a broader repertoire and representation. The amount of influence of prehistoric tradition depends on the continuity of prehistoric and Roman settlements, on the persistence of prehistoric pottery (among other things) tradition and on the ability of new potters to transfer and maintain knowledge.

The specificities of the locally produced functional ceramics are related to certain micro regions. There are certain specificities within one region, that cannot be noted to that extent in other areas. There are differences within the micro region, among the individual sites, i.e. a part of the locally produced functional ceramics can exclusively be found on one site. That refers to the shape, decorations and technology. The study of ceramics largely contributes to the understanding of life in Antiquity and the study of locally produced ceramics with all the micro regional particularities and it is important for understanding of everyday habits in specific areas, and differences between regions. Intense archaeological explorations that have been conducted over the last few years retrieved a large amount of archaeological material. A thorough processing of the complete ceramic material will enable the recognition and completion of micro regions. It is assumed that micro regions were formed around a centre (not necessarily a colony or municipium centre), presuming there was a developed communication and basic raw materials (clay, water, woods).<sup>1</sup> However, despite the proximity of a centre every inspected site has specific materials, which are different from the local ceramics from that centre.

The locally produced functional ceramics were quickly depleted, because they were used every day, exposed to thermal shocks and often moved, which means that they changed fast and that their lifetime was short – much shorter than the lifetime of the tableware, which could be used for many years. It is unfortunate that the locally produced functional ceramics did not change their shape for a long period of time, consequently it is difficult to date them, unless there is a <sup>14</sup>C analysis or other reliable archaeological material.

1 Do takvih zaključaka za područje Slovenije došla je Mikl Curk (Mikl Curk 1973: 893).

1 Mikl Curk concluded this for the territory of Slovenia (Mikl Curk 1973: 893).



<sup>14</sup>C analize ili drugi pouzdani arheološki materijal.

U južnoj Panoniji i njenoj bližjoj okolici registrirano je više keramičarskih proizvodnih centara, koji su svoju robu s lakoćom mogli plasirati na tržište zbog razvijene prometne mreže, ali pored tih centara (*Poetovio*, *Neviodunum*, *Andautonia*, *Aquae lasae*, Jalžabet-Bartolovec, *Iovia* (*Botivo*), Vipavska dolina, Brezje, Bobovk kod Kranja, Osek kod Gradišća, *Emona*, *Celeia*, *Siscia*, *Mursa*, *Cibalae*, *Sirmium*, *Certissa*) koji su proizvodili provincijsku keramiku različite namjene (Vikić 1971: 91–92) postojao je veliki broj pojedinaца koji su izrađivali uporabnu keramiku čije je proizvode teško prepoznati i izdvojiti, budući da nisu proizvedeni u organiziranim radionicama i radi se o manjoj količini robe koju je samom tom činjenicom teže pratiti.

Velika količina uporabne keramike lokalne proizvodnje koja je tipološki i strukturalno raznolika, ukazuje na to da je postojao niz pojedinaца koji su radili keramiku za kućnu uporabu za ruralne, ali i urbane sredine, a o kojima se vrlo malo zna. Zbog velikog broja samostalnih lončara koji djeluju u nekoj mikroregiji i zbog utjecaja različite uvezene robe, dolazi do oblikovanja osebujnih i specifičnih oblika koje je teško svrstati u određene okvire upravo zbog njihove posebnosti. Daljnjom obradom materijala svih istraženih lokaliteta i obradom uporabne keramike lokalne proizvodnje, trebalo bi moći odrediti granice mikroregija.

U ovom trenutku može se pretpostaviti da je na "formiranje" mikroregija utjecalo postojanje zemljopisnih cjelina, prometne povezanosti, postojanja municipalnih centara i njihove blizine. Na njihovo oblikovanje mogla je utjecati i prapovijesna osnova odnosno organizacija ljudi koji su na tom području živjeli prije dolaska Rimljana i organizacije uprave u Carstvu. To su neki osnovni i polazni elementi koje će u daljnjim istraživanjima ove vrste keramike trebati dopuniti detaljnom analizom samog keramičkog materijala gdje treba uzeti u obzir tradiciju prapovijesnog lončarstva, osvrnuti se na onu keramiku koja je na području koje se ispituje uvezena, različite potrebe i zahtjeve tržišta. Bitan element u daljnjem istraživanju bit će i usporedba keramike lokalne proizvodnje svih lokaliteta. U svakom naselju postojali su različiti utjecaji u različitoj mjeri što se opet odrazilo na oblikovanje keramike.

Na ovom, jugoistočnom dijelu Gornje Panonije, postoji municipalni teritorij čije je središte bilo na području današnjeg *Daruvara-Aquae Balissae*,<sup>2</sup> a prostire se u kru-

Several ceramic production centres are registered in southern Pannonia and its close proximity. Those centres could easily put their goods on the market because of the developed traffic network. Alongside these centres (*Poetovio*, *Neviodunum*, *Andautonia*, *Aquae lasae*, Jalžabet-Bartolovec, *Iovia* (*Botivo*), Vipava valley, Brezje, Bobovk near Kranj, Osek near Gradišće, *Emona*, *Celeia*, *Siscia*, *Mursa*, *Cibalae*, *Sirmium*, *Certissa*) which produced provincial ceramics for various uses (Vikić 1971: 91–92), there was a large number of individuals who manufactured functional ceramics, whose products are hard to tell apart and single out, since they are not manufactured in organized workshops and there is a small number of them.

A large amount of the locally produced functional ceramics is diverse in typology and fabric which indicates that there were many individuals who manufactured domestic ceramics for rural and urban areas, about whom very little is known. As a result of a large number of individual potters who work in a micro region and the influence of various imported goods, peculiar and specific shapes are formed, which are hard to classify due to their specificity. It should be possible to determine the borders of micro regions with further analysis of the material from all the researched sites and by processing the locally produced functional ceramics.

In this moment, it can be assumed that the existence of geographical units, traffic connections, municipal centres and their vicinity affected the "forming" of micro regions. Prehistoric base and the organization of the people that lived in that area, before Romans arrived and before the organisation of administration in the Empire, could also influenced their formation. These are some basic and initial elements that will have to be complemented in further research with a detailed analysis of the ceramic material, taking account of the tradition of prehistoric pottery, the imported ceramics in the area, diverse market needs and demands. The important element for further research will be the comparison of locally produced ceramics from all sites. There were different influences of different extent in every settlement, which reflected on the moulding of ceramics.

In the south-eastern part of Upper Pannonia, there is a municipal territory with its centre in the area known today as *Daruvar-Aquae Balissae*,<sup>2</sup> and it extends around 50 km

2 Taj prostor bio je naseljen Jasima, točnije radi se o području od Varaždinskih Toplica i rijeke Sutle na zapadu, Dravom prema istoku do Slatine, zatim na jugozapad do Velike, prema jugu do područja gdje ono graniči sa sisačkim područjem te na jugozapad gdje graniči s područjem municipija *Andautonia*. Ekspanzijom Tauriska, Jasi dospijevaju pod njihovu vlast u 3. st. pr. Kr. te se s drugim plemenima koje su Kelti pokorili smatraju nosiocima latenske kulture koju su na ovom području zatekli Rimljani. Epigrafski izvori upućuju na očuvanje imena i jezika Jasi i prihvaćanje keltskog materijala i drugih aspekata kulture. Naselje Tauriska s ponekim tradicijama starijeg autohtonog stanovništva pronađeno je nedaleko od Virovitice Kiškorije jug na lokalitetu Virovitica Kiškorija sjever (udaljeni su oko 300 m) koje je datirano od druge polovice 2. do u drugu polovicu 1. st. pr. Kr. Na Virovitici Kiškoriji sjever među keramičkim nalazima ima i onih posuda

2 This area was inhabited by Jasi, more accurately it is the area from Varaždinske Toplice and river Sutla on the west, following the Drava river to the east to Slatina, then to the southwest to Velika, towards the south to the neighbouring Sisak area and on the southwest until the border with *Andautonia* municipality. With the expansion of Taurisks, Jasi came under their authority in 3<sup>rd</sup> century BC and are, with other tribes that were conquered by the Celts, considered the bearers of *La Tène* culture which was found in this area by the Romans. The epigraphic sources suggest that Jasi preserved their name and language and adopted the Celtic material and other aspects of culture. A Taurisk settlement, with some traditions from older indigenous people, was found nearby Virovitica Kiškorija south on the site Virovitica Kiškorija north (300 m away), it was dated from the second half of the 2<sup>nd</sup> until the second half of the 1<sup>st</sup> century BC. There are some

gu od približno 50 km oko svog središta. Taj municipalni prostor obuhvaća područje Virovitice, a organizirano je na način da u njemu postoji niz sela i mjesta uz prometnice za prenočište i promjenu konja. Oblični Orešac tako je iz izvora poznat kao *mutatio Bolenta*<sup>3</sup>, a Virovitica Kiškorija jug nalazi se između stanica na cesti (prema istom izvoru) *Mutatio Cocconis* i *Mansio Serota* (Špišić Bukovica i Taborište/Borova(?), pola kilometra sjeverno od položaja Antunovac gdje je uočena rimska cesta (*Itinerarium Hierosolymitanum/Burdigalense* 560–63, Kukuljević-Sakcinski 1873: 108; Mayer 1935: 69–82; Soproni 1980b: 213; Schejbal 2003a: 95–120; 2003b: 393/416; 2004: 99–103). Četiri lokaliteta s ovog municipalnog područja (Orešac, Virovitica Kiškorija jug, Radovanci - Brdo i Macute) imaju tipološki, tehnološki i strukturalno srodnu keramiku, a postavlja se pitanje, ima li to veze tim municipalnim područjem. S obzirom na veličinu područja, pretpostavljam u ovom trenutku kako se područje nekog municipaliteta ne može podudarati u potpunosti sa specifičnostima oblikovanja lokalne keramike, jer kako će se u kasnijim poglavljima vidjeti, na formiranje keramičkih oblika, ukrasa i tehnologiju utječu brojne druge činjenice i svaki lokalitet je sa svojom lokalnom proizvodnjom zasebna cjelina koja zahtijeva individualan pristup povijesnoj pozadini tog kraja, osvrt na zemljopisne uvjete, cestovnu povezanost i odnose prema drugim okolnim naseljima. Za svaki lokalitet svi ti elementi su različiti, što je i uzrok raznolikosti lokalno proizvedene keramike.

Umješnost lokalnih lončara sigurno nije bila dobra kao u organiziranim radionicama, posebno u onim specijaliziranim. Zbog toga su jednostavni oblici prisutni jer ih je bilo i najlakše napraviti, a vjerojatno su bili i najpraktičniji. Jednostavnost i praktičnost u svakom su slučaju za posuđe u svakodnevnoj upotrebi u domaćinstvu bili važni.

Uporabna keramika nije se samo proizvodila u selima i u rustičnim vilama za potrebe tih vila i sela. Nju su proizvodili i u radionicama u većim centrima. Radi se o keramici proizvedenoj u radionicama koja je i tehnološki superiornija, a radili su je lončari koji se bave proizvodnjom keramike, te su je pekli u pećima gdje su mogli kontrolirati uvjete pečenja. Tako proizvedena keramika može biti lokalnog karaktera samo ako je namijenjena lokalnom tržištu, tj. ona je lokalnog karaktera po svojoj distribuciji. Keramika koju su izradili pojedinci - lončari izvan organiziranih radionica za potrebe svojih sredina, u mikroregijama, prema literaturi je tehnološki inferiornija ako je pečena u jednostavnim pećima ili bez njih, često je rađena rukom, a ponekad je samo dorađena na kolu. Smatra se lošije kvalitete budući da ti pojedinci - lončari nisu imali uvjeta, a ni potrebe st-

around its centre. This municipal territory includes the area around Virovitica and it is organized in a way that there are numerous villages, lodgings and places for exchanging horses by the roads. Nearby Orešac is known from the sources as *mutatio Bolenta*,<sup>3</sup> and Virovitica Kiškorija south is situated between the two stops on the road (according to the same source) *Mutatio Cocconis* and *Mansio Serota* (Špišić Bukovica and Taborište/Borova(?), half a kilometre north from the position Antunovac, where the Roman road has been spotted (*Itinerarium Hierosolymitanum/Burdigalense* 560–63, Kukuljević-Sakcinski 1873: 108; Mayer 1935: 69–82; Soproni 1980: 213; Schejbal 2003a: 95–120; 2003b: 393/416; 2004: 99–103). Four sites from this municipal territory (Orešac, Virovitica Kiškorija south, Radovanci - Brdo and Macute) have ceramics similar in typology, technology and fabric, and it is questionable if these similarities have anything to do with the municipal territory. Considering the size of the area, I suppose that the territory of a municipality cannot entirely coincide with the specificities of moulding of the local ceramics, which will be explained in later chapters. Numerous other facts influence the moulding of ceramic objects, decorations and technology and every site with its local manufacture forms a separate unity. That requires an individual approach to the historical background of that area, geographical conditions, road connections and relations with other surrounding settlements. All these elements are different on every site, which is the cause of the diversity of locally produced ceramics.

Craftsmanship of local potters was not as good as in the organized workshops, especially in the specialized ones. That is why the simple shapes are present, for they were the easiest to make and probably the most practical. In any case, simplicity and convenience were important for pottery that was used on daily basis.

The functional ceramics were not only manufactured in villages and villae rusticae for the needs of those villages and villae rusticae. It was also manufactured in the workshops in the bigger centres. These ceramics were technologically superior, made in workshops by potters who specialized in manufacturing of ceramics and fired it in kilns, in which they could have controlled the firing conditions. The ceramics produced this way can only be of the local character if it is designated for the local market, i.e. it is local by its distribution. The ceramics manufactured by individuals – potters who work outside organized workshops and who produce for the needs of their communities, in micro regions, is technologically inferior if it were fired in simple

koje se mogu pripisati tradiciji panonskog autohtonog stanovništva kojeg su Kelti tu zatekli. Istraživanja i pronađeni materijal govore o jakom utjecaju i prisutnosti Tauriska dok antroponimi i natpisi govore o očuvanosti panonskog stanovništva (Domić Kunić 2003: 178; Horvat et al. 2003: 158; Schejbal 2003b: 395–396; Dizdar 2006a: 89; 2006b: 59; 2007: 39, 43).

3 Prema *Itinerarium Hierosolymitanum/Burdigalense* 560-63 (Kukuljević-Sakcinski 1873: 108; Soproni 1980: 213).

pots among the ceramic material found in Virovitica Kiškorija north that were not made according to tradition of indigenous Pannonian population found on this area by Celts. The strong influence and the presence of Taurisks is evidenced by the research and found material, while the anthroponyms and inscriptions evidence the preservation of the Pannonian population (Domić Kunić 2003: 178; Horvat et al. 2003: 158; Schejbal 2003b: 395–396; Dizdar 2006a: 89; 2006b: 59; 2007: 39, 43).

3 According to *Itinerarium Hierosolymitanum/Burdigalense* 560-63 (Kukuljević-Sakcinski 1873: 108; Soproni 1980: 213).



voriti dobro kontrolirane uvjete proizvodnje. Uporabna keramika, pa tako i ona za kuhanje, nije zahtijevala nikakve posebne tehnike pa ni upotrebu kola za njenu izradu, ali je morala imati određene tehnološke specifičnosti kako bi mogla služiti svojoj svrsi (Peacock 1997: 28). Upravo te tehnološke specifičnosti važne su za ovu vrstu keramike, a odnose se prije svega na sastav i kvalitetu pečenja.

Zbog toga, smatram da treba razlikovati uporabnu keramiku lokalne proizvodnje na onu proizvedenu u radionicama gdje su radili obučeni lončari gdje se proizvodilo i provincijsku keramiku, od uporabne keramike koju su lončari koji su to radili povremeno, po potrebi, koja se pokazala na lokalnom tržištu ili za vlastite potrebe. Prva skupina uporabne keramike zbog tehnoloških je predispozicija kvalitetnija od ove druge i mogla je utjecati na drugu ukoliko to zemljopisni i cestovni uvjeti potpomažu.

Područje unutar kojeg je cirkulirala lokalno proizvedena keramika prema istraživanjima koja su provedena na intenzivno iskopanim i objavljenim lokalitetima govore kako se radi o području distribucije od oko 30 km (Petznek 1997 (1998): 170, 190).

Kada se u slučaju lokaliteta Virovitica Kiškorija jug govori o lokalnoj proizvodnji i lončarima koji su manje vješti to znači samo to da su manje vješti od lončara kojima je to zanimanje, ali oni ipak posjeduju određenu vještinu i znanje. Za vrhunski proizvod pored izvrsnog znanja i vještine potrebni su i drugi uvjeti kao što su dobra glina i dobra peć, povoljni uvjeti za pročišćavanje gline, sušenje i hlađenje posuda. Standard tih preduvjeta je zasigurno bio viši u organiziranim radionicama u odnosu na prostor kojim je raspolagao lončar koji se proizvodnjom posuda bavio povremeno.

Proizvodnja uporabne keramike isključivo za lokalno tržište itekako ima smisla. Transport robe, pa tako i keramike, uključuje veće cijene, ali i neučinkovitost (Garnsey, Seller 1987: 90) ukoliko se radi o krhkoj i manje kvalitetnoj robi koja ne bi izdržala putovanje na veće udaljenosti. Transport ovakve robe također nema smisla pogotovo na onim mjestima gdje je postojala glina, voda i dovoljno šume za loženje peći te je zbog toga i logično da se u najmanjim sredinama razvila proizvodnja uporabne keramike na nivou pojedinih lončara koji su te proizvode radili povremeno, ovisno o potrebama zajednice. Ipak je i te potrebe trebalo predvidjeti zbog planiranja proizvodnog procesa i njegovih tehnoloških zahtijeva: uzimanje sirovine, sušenje posuda, pečenje i hlađenje. Za pretpostaviti je da su takvi lončari imali svojevrstnu zalihu svojih proizvoda te da su se tom djelatnošću bavili u etapama zbog tehnološke prirode proizvodnog procesa.

Dugogodišnjim istraživanjima britanski su autori u radu na keramici postigli velike rezultate. Između ostalog, detaljno analiziraju i problem proizvodnje keramike pored problema distribucije. Predlaže se više modela proizvodnje na temelju etno-arheološkog pristupa, odnosno na te-

kilns or without them, often by hand and rarely finalized on a wheel. It is considered lower in quality, since these individuals – potters did not meet the requirements, nor have the need to provide well controlled conditions. The functional ceramics, including the ceramics used for cooking, did not require special manufacturing techniques or the use of a wheel, but it had to meet certain technological requirements to serve its purpose (Peacock 1997: 28). These technological specificities are important for this type of ceramics and they primarily refer to the composition and the quality of firing.

That is why I think that we should divide the locally produced functional ceramics into the ones manufactured in workshops, where skilled potters worked and where the provincial ceramics were also produced and into the functional ceramics that were occasionally made by potters, according to the needs on the local market or for their own needs. The first group of the functional ceramics is of the higher quality than the second one and could have influenced the second one under the right geographical and road conditions.

According to the research done on the intensely excavated and published sites, the locally produced ceramics circulated within the area of around 30 km (Petznek 1997 (1998): 170, 190).

In case of local manufacture and less-skilled potters from the site Virovitica Kiškorija south, which are less-skilled compared to potters by vocation, but nonetheless they have certain skills and knowledge. Many other requirements, besides top knowledge and skills, are necessary to make an excellent product, like high quality clay and a kiln, good conditions for clay purifying, drying and cooling of vessels. There was certainly a higher standard of these preconditions in the organized workshops, than in the space where the potter that occasionally made pottery worked.

The production of functional ceramics for the local market definitely makes sense. Transport of goods, including the transport of ceramics, increases the costs, as well as the inefficiency (Garnsey, Seller 1987: 90) if it concerns low-quality goods unsuitable for long distance transportation. It is unreasonable to transport these kinds of goods in the places where clay, water and enough wood to fire the kilns are available. Consequently, the manufacture of the functional ceramics had developed even in the smallest settlements, on the level of individual potters who occasionally manufactured, depending on the needs of community. Even those needs should have been predicted, because of the planning of manufacturing process and its technology requirements: raw materials intake, pottery drying, firing and cooling. It can be assumed that these potters had a stock of their products and that they made their pottery in stages meeting the technological conditions of the manufacture process.

melju arheoloških spoznaja i promatranja današnjih zajednica. Što se tiče raznih modela proizvodnje, ponekad ih je teško prepoznati zbog manjkavih i teško prepoznatljivih arheoloških ostataka, prije svega samih mjesta gdje se pekla takva keramika (Peacock 1997: 12, 25/26; Tyers 1999: 34–35). Osim što ih je teško prepoznati, još ih je teže i dokazati. Peacock razlikuje više modela proizvodnje koji bi se mogli uklopiti u okvir lokalne proizvodnje ovog dijela Gornje Panonije, odnosno mikroregije. Manjkavost arheoloških nalaza onemogućava detaljno opredjeljivanje za jedan od takvih modela. On tako predlaže osam modela, od kojih su 3 primjenjiva na lokalitet Virovitica Kiškorija jug:

- povremena kućna proizvodnja za potrebe samog pojedinog kućanstva u vrlo jednostavnoj tehnologiji,
- povremena proizvodnja s namjerom zamjene robe, također povremena ili sezonska, a radi se također o jednostavnoj tehnologiji,
- treći model je također sezonski, orijentiran je prodaji, podrazumijeva upotrebu kola i peći i jednostavne modele distribucije (Peacock 1997: 13–31; Tyers 1989: 34–35).

Keramika koja se koristila na lokalitetu Virovitica Kiškorija jug uglavnom nije rađena na kolu, pečena je u uvjetima koji se nisu mogli dobro kontrolirati, znači u jednostavnim pećima, jamama ili na otvorenoj vatri. Bez obzira na tipološku raznovrsnost, prisutni oblici su dosta ujednačeni u svojoj jednostavnosti pa se nameće zaključak o povremenoj i sezonskoj proizvodnji pojedinog ili pojedinih lončara koji su koristili jednostavnu tehnologiju izrade i pečenja posuda, koje su distribuirane na strogo lokalnom tržištu ili čak unutar samog naselja. Tipološki, tehnološki i strukturalno (makroskopski gledano) ova keramika istovjetna je keramici iz Orešca (Jelinčić 2009). Postavlja se pitanje gdje je ta keramika izrađena, na kojem od ova dva lokaliteta ili su možda oba lokaliteta imala proizvodnju. Orešac je veće naselje, pa bi bilo logično da je proizvedena tamo ukoliko se proizvodila samo na jednom mjestu. Kako se radi o maloj udaljenosti, moguće je da je geološka podloga slična, tj. da je glina korištena za izradu posuda sličnih karakteristika što je rezultiralo i keramikom zajedničkih strukturalnih obilježja. Ove pretpostavke mogu se preispitati geokemijskim analizama više uzoraka gline i keramike s oba lokaliteta.

U lokalno proizvedenoj keramici može se prepoznati funkcija ako su ti predmeti pronađeni u neporemećenoj stratigrafiji velikog stambenog objekta, za razliku od predmeta pronađenih u otpadnim jamama gdje nisu cjeloviti i gdje su odvojeni od mjesta gdje su vršili svoju primarnu ulogu (Tyers 1999: 42). Tako razlikujemo keramiku koja se koristila za kuhanje, pripremanje, serviranje i čuvanje hrane. Imena posuda također govore mnogo o njihovoj ulozi, a grafiti koji se ponekad nalaze na posudama o sadržaju i količinu koju su mogli primiti (Tyers 1999: 42).

Problematika uporabne keramike lokalne proizvodnje

Long time research of ceramics conducted by British authors has yielded considerable results. Among other, they analyse in detail the problem of manufacturing ceramics along with its distribution. They propose several models of production based on ethno-anthropological approach, archaeological knowledge and observation of today's communities. Sometimes different production models are difficult to identify, because of the deficient and hardly recognizable archaeological remains, primarily places where the ceramics were fired (Peacock 1997: 12, 25/26; Tyers 1999: 34–35). Besides being hard to recognize them, it is even harder to prove them. Peacock differs several types of production, which can be fitted in the local production of this part of Upper Pannonia, i.e. its micro region. The lack of archaeological discoveries disables us to choose just one of those types. He proposes eight types, of which three can be applied on the Virovitica Kiškorija south site.

- occasional home manufacture for the needs of a single household, with simple technology,
- occasional manufacture of trading goods (also occasional or seasonal), with simple technology,
- the third model is also seasonal, intended for trade, with the use of the wheel, kiln and simple model of distribution (Peacock 1997: 13–31; Tyers 1999: 34–35).

Ceramics which were used on the Virovitica Kiškorija south site were rarely wheel made. They were fired under badly controlled conditions in simple kilns, pits or on open fire. Regardless of the typological diversity, the forms are fairly uniform in their simplicity. Consequently, they must have been made occasionally and seasonally by individual potters, who used simple technology of manufacturing and firing vessels. These pots were strictly distributed on the local market or within the settlement. These ceramics are typologically, technologically and structurally (macroscopically viewed) identical to the ceramics from Orešac (Jelinčić 2009). The question is whether these ceramics were made on one of these two sites or on both. If they were made on only one site it would be logical that they were made in Orešac, it being a bigger settlement. Since it is a short distance, the geological foundation could be similar, i.e. the characteristics of the clay used for the pot manufacturing could be similar, which would result in ceramics with common structural features. These assumptions can be verified by geochemical analysis of clay and ceramics from both sites.

We can identify the function of locally produced ceramics, when it is retrieved from a bigger residential building with undisturbed stratigraphy, unlike the objects found in waste pits which are not whole and which are not the location they were used at (Tyers 1999: 42). Thus, we can differentiate ceramics used for cooking, preparing, serving and food storage. We can learn more about the function of vessels according to their names and about their con-



i tipologija tog posuđa složena je i uključuje poznavanje svih elemenata. Jedan od važnih elemenata su i lončari. O njima se malo zna iz izvora. U organiziranim radionicama lončari su mogli biti robovi, a pečati na keramici govore i o libertinima (Tyers 1999: 45; Sanader 2008: 20). Za vrijeme svoje službe dio rimskih vojnika radio je na proizvodnji keramike i opeka. Moguće je da se i netko od njih po umirovljenju povremeno bavio lončarstvom, barem za potrebe svoje obitelji, vile ili naselja. Uporabnu keramiku lokalne proizvodnje za vlastite potrebe mogle su izrađivati i žene. Iz Siska postoje potvrde o postojanju radnika koji su izrađivali opeke, a čiji se radni učinak bilježilo na dnevnoj razini. Smatra se da je takva evidencija postojala zbog ugovora koji su postojali između radnika i vlasnika radionice odnosno zbog evidencije količine proizvedenih opeka i lakšeg podmirivanja dugova prema radniku. Natpisi s opeka iz Siska su bili praktični i zbog toga što se na njima navodi i datum što je olakšavalo kontrolu postupka sušenja onih opeka proizvedenih taj dan (Matijašić 1986: 212–213). Vitruvije navodi drugačije podatke, ali treba imati na umu da on govori o proizvodnji na Mediteranu, o proizvodnim centrima s drukčijom klimom nego što je ova u Gornjoj Panoniji (*Vitr. II, 3*).

Proizvodnja keramike je na lokalitetu Virovitica Kiškorija jug mogla biti sezonska također iz praktičnog razloga, a to su klima i problem sušenja tijekom zimskih mjeseci. Ovdje ponovno treba spomenuti opeke iz Siscije koja se nalazi upravo u Gornjoj Panoniji, a one su važne zbog datuma koji su zabilježeni na njima. Riječ je o razdoblju između kraja svibnja i kraja rujna, to je razdoblje koje je bilo najpovoljnije za sušenje proizvoda. Ne može se uspoređivati organiziranu proizvodnju opeka u Sisciji gdje su se tijekom ljetnih mjeseci izrađivale i sušile opeke, tijekom rane jeseni one su se pekale, a preko zime se sakupljalo i pripremalo glinu (Matijašić 1986: 208–209) budući da je tu riječ o organiziranoj proizvodnji čiji su proizvodi namijenjeni velikom tržištu i široj distribuciji, a lokalna proizvodnja podrazumijeva manje tržište, a time i manju količinu potrebnih proizvoda.

Keramika lokalne proizvodnje u mikroregiji kojoj pripada Virovitica Kiškorija jug je mekana, rađena je od gline s dodatkom pijeska. Njena površina je zaglađena, premazana u funkcionalne svrhe i u pravilu bez ukrasa. Uz ovu najbrojniju keramiku, prisutna je i lokalno proizvedena uporabna keramika s velikom količinom primjesa kvarca i tinjca različite granulacije, povoljna za kuhanje. Prema Vikić-Belančić lokalna keramika jugozapadnog dijela Panonije rađena je s dosta primjesa kvarca, površina joj je u pravilu jako gruba te je ukrašena različitim motivima izvedenim češljastim ukrasom ili valovnicom (Vikić-Belančić 1965: 100–103; 1975: 30–32). Kako svaki pregledani lokalitet ima keramiku koja se ne javlja na nijednom drugom lokalitetu, pretpostavlja se proizvodnja te keramike na samim lokalitetima ili u neposrednoj okolici. To znači i uzimanje

tent and volume quantity according to the graffiti on them (Tyers 1999: 42).

The problematic of the locally produced functional ceramics and the typology of that tableware is complex and includes the understanding of all elements. The potters are an important element. Very little is known about them. The potters in the organised workshops could have been slaves, although the seals on ceramics mention libertines as well (Tyers 1999: 45; Sanader 2008: 20). Some of the Roman soldiers during their military service worked in the production of ceramics and bricks. It is possible that some of them, when retired, occasionally manufactured pottery at least for their families, villas or settlements. Moreover, women could have manufactured the locally produced ceramics for their own needs. There is confirmation about workers who produced bricks in Sisak, with the daily record of their work performance. They probably kept these records because of contracts between workers and workshop owners as well as to keep track of the produced bricks and debt settlement. Inscriptions on the bricks from Sisak were also practical; by stating the date of the production they facilitated the drying process of the bricks made that day (Matijašić 1986: 212–213). Vitruvius states different information, but he speaks about the production in the Mediterranean, about centres of production with a climate different from the Upper Pannonia (*Vitr. II, 3*).

The ceramics production on the Virovitica Kiškorija south site may have been seasonal because of the climate and drying problems during the winter months. The bricks from Siscia, in the Upper Pannonia should be mentioned again in order to stress the importance of dates inscribed on them. It is a time period from the end of May until the end of September, which is best-suited for the drying of products. The organised brick production in Siscia, where bricks were produced and dried during the summer months, fired during the early Autumn and where clay was collected and prepared during the winter (Matijašić 1986: 208–209), and since products were designated for big markets and large distribution, cannot be compared to the local production which implies smaller markets and thereby a small amount of products.

The ceramics from the micro region, where Virovitica Kiškorija south is situated, are soft and made from clay that was mixed with sand. They have smooth surface that is coated for functional purposes and mainly without the decorations. Along with these ceramics which are the most numerous, there are locally produced functional ceramics mixed with a large quantity of quartz and mica of various granulation, which is suitable for cooking. According to Vikić-Belančić, the local ceramics from the south-western part of Pannonia are made with a lot of quartz, their surface is mostly very coarse and decorated with diverse motives that were made by a decorative comb or a wavy line (Vikić-Belančić 1965: 100–103; 1975: 30–32). Since the ce-



sirovine iz neposredne blizine, što nužno znači i strukturalnu razliku (barem minimalnu) keramike tog lokaliteta u odnosu na keramiku s drugih lokaliteta. Zbog toga je pogrešno donositi opće zaključke kakva je keramika nekog velikog područja budući da je ona samo lokalnog karaktera i određena je lokalnom sirovinom, kada govorimo o njenim strukturalnim obilježjima. Razlike u strukturi keramike istog tipa posude upućuju na drugu sirovinu, drugog lončara i drugo područje proizvodnje. Za očekivati je da je keramika istovjetna ili srodna u tipološkom, tehnološkom i strukturalnom pogledu isključivo na onim lokalitetima koji su međusobno blizu, unutar kruga od 20–30 kilometara. Točnu udaljenost ovih lokaliteta s međusobno srodnom ili istovjetnom keramikom treba gledati od lokaliteta do lokaliteta i regije do regije budući da to ovisi o jačini centra gdje se ta keramika proizvodila, prirodno-zemljopisnim uvjetima te infrastrukturi.

Lokalna proizvodnja rimske keramike odnosi se na mikroregije uvjetovane zemljopisnim cjelinama, prapovijesnom podlogom tj. prostornom organizacijom područja prije dolaska Rimljana i postojanjem urbanih centara kao proizvodno trgovačkih središta koji šire svoje proizvode, utjecaj i tehnološke spoznaje. Pod lokalnom proizvodnjom podrazumijeva se proizvodnja keramike za pripremu (tarionici, zdjele, tanjuri), kuhanje (prije svega lonci, zatim zdjele, tronošci i tanjuri),<sup>4</sup> čuvanje (veliki lonci, vrčevi) i serviranje hrane (zdjele i tanjuri) grublje fature za korištenje unutar mikroregije gdje je proizvedena. Odlikuje se strukturalnom, tehnološkom i tipološkom srodnošću što je razlikuje od uporabne keramike lokalne proizvodnje drugih mikro regija.

Unutar mikroregije, djeluje niz obrtnika koji mogu raditi unutar organizirane radionice, ali i povremeno kao pojedinci za vlastite potrebe (obitelj), potrebe imanja (rustična vila), za potrebe malog tržišta (mala naselja). Tu govorimo o organizacijskim kriterijima lokalne proizvodnje keramike. U velikim gradovima kao što je Siscija, također se koristila uporabna keramika i ona nije predstavljala luksuz. Međutim, ako uzmemo u obzir postojanje radionica za provincijsku keramiku u tom gradu, tehnološko poznavanje i uvjeti rada su u takvom gradu veći i bolji nego što ih ima lončar u selu. Izrada uporabne keramike lokalne proizvodnje u gradovima ne mora biti nužno organizirana. Nju su mogli proizvoditi pojedinci za vlastite potrebe ili za lokalno tržište. Takvu keramiku nalazimo upravo u Sisciji gdje pored velike količine uvezene keramike i keramike provincijskog karaktera nalazimo veliku količinu lokalno proizvedene uporabne keramike kakvu srećemo samo u tom gradu.

Također na selu ili na rustičnoj vili, za očekivati je brojnu

ramics found on every examined site cannot be found on any other site, we can assume that ceramics were manufactured on the site or in the immediate surroundings. That includes taking of the raw materials in the vicinity, which results in structural differences (at least minimal) between the ceramics on each site. Consequently, it is wrong to make general conclusions about the ceramics on a large area, as they are local and can be specified by the raw materials, in connection with the structural features. Differences in ceramics fabrics of the same type of pots indicate a different raw material, a different potter and a different production area. It is expected that the ceramics are typologically, technologically and structurally identical or similar on sites close to one another, within a 20–30 kilometre radius. The exact distance between the sites with identical or similar ceramics should be individually calculated for each site and region, because it depends on the power of the manufacturing centre, natural and geographical conditions and infrastructure.

The local manufacture of Roman ceramics refers to micro regions which were conditioned by geographical regions, prehistoric background, i.e. organization of the area before the Romans came, and the existence of urban centres as the centres of production and trade that spread their influence, products and technological knowledge. The local manufacture comprises the manufacture of ceramics for food preparation (mortars, bowls, plates), cooking (first of all pots, bowls, tripods and plates),<sup>4</sup> storage (big pots, jugs) and serving (bowls and plates). These ceramics were made of coarser fabric and designated for use in the micro region where they were made. It is structurally, technologically and typologically similar, contrary to the other locally produced functional ceramics within the other micro regions.

Many craftsmen work within a micro region, they can work in an organised workshop, but occasionally also as individuals for their own needs (family), estate needs (villa rustica) or small market needs (small settlements). We are talking here about the organisational policies of local ceramics manufacture. In big towns like *Siscia*, functional ceramics were used and they were not a luxury. However, in towns like *Siscia* there were workshops which produced provincial ceramics, they had the technological knowledge and better working conditions than the potters in villages. The manufacture of local ceramics in towns is not necessarily organised. It might have been manufactured by individuals for their own needs or the local market. This type of ceramics are present in *Siscia*; together with a large amount of imported ceramics and provincial ceramics there is a large amount of the locally produced functional

4 Prema tragovima gara i kamenca zaključeno je da su lonci najviše upotrebljavani za kuhanje, a po broju im slijede zdjele. U vrlo rijetkim slučajevima tragovi gara primijećeni su na vrčevima i čašama. Pirjanje je bila najčešća tehnika kuhanja sudeći prema tragovima gara i oblicima posuda (Cool 2006: 37–39).

4 Based on the sooth and lime remanins it was concluded that the pots were the most used for cooking, followed by bowls. In very rare cases, sooth traces were noticed on jugs and cups. Based on the sooth remains and shapes of the vessels the most common cooking technique used was stewing. (Cool 2006: 37–39).



pojavu keramike kakvu upravo srećemo na lokalitetu Virovitica Kiškorija jug. Rukom rađena keramika, jednostavna i praktična, tehnološki nije na zavidnom nivou, pečena u uvjetima koji se nisu dobro kontrolirali. Unatoč tome poznat je iz iskopavanja niz primjera gdje se na rustičnim vilama organizirano proizvodila keramika različitih vrsta: uporabna, građevinska, stolna, uljanice, keramoplastika, transportna keramika. Keramika proizvedena na takvim mjestima, mogla je biti namijenjena potrebama samog sela, rustične vile, ali i za daljnju distribuciju. Poznat je primjer rustične vile na lokalitetu Tâc-Fövenypusta gdje je postojala keramičarska radionica (Thomas 1955: 107, Abb. 3. 67, 122, 123, T. Ll: 17). Tu treba biti oprezan jer je u tom slučaju nije riječ o lokalnoj proizvodnji.

Lokalno proizvedena keramika je isključivo ona koja je proizvedena u nekoj mikroregiji, a namijenjena je korištenju ili prodaji unutar te mikroregije.

Potreba za keramikom koja se koristila za kuhanje, pripremanje, serviranje ali i čuvanje bila je stalna zbog oštećenja i razbijanja tih posuda ili jer to nalaže recept. Stalnim korištenjem njezin premaz slabi, uništava se, a gubi se i mogućnost da se ona kvalitetno opere, očisti i oslobodi neugodnih naslaga i mirisa. Time se u njene pore zadržava hrana čime posuda postaje neprikladna za daljnje korištenje. Tarionici su se stalnom upotrebom također habali, jer se stalnim mrvljenjem sastojaka, kamenčiće čija je uloga bila da drobe sastojke istrošilo. Lonci za kuhanje su se zbog čestog korištenja i micanja najčešće lomili te je to najvjerojatniji razlog zbog kojeg ih ima u najvećem broju (Peña 2007: 40–43, 57–58). Kako krhkost lokalno proizvedene uporabne keramike nije dozvoljavala veliki transport, a zbog svoje vrijednosti to se nije ni isplatilo, postojala je opravdana potreba za velikim brojem organiziranih lončara ili pojedinaca koji su podmirivali svakodnevne potrebe za uporabnom keramikom.

**3.3.1. Lonci** (lat. *aula, olla, urna*, eng. *pot*, njem. *Topf, Urnen*, tal. *olla*, fra. *pot*)

*Aula/aula, ola/olla* je nazivlje za rimsko kuhinjsko posuđe korišteno za kuhanje. Ono je stajalo na ognjištu ili je visjelo iznad njega, a moglo je služiti i za čuvanje različite tekuće i krute hrane i namirnica. Ovaj je keramički oblik mogao biti korišten i u sakralne svrhe. *Olla ossuaria* je služila za držanje kremiranih posmrtnih ostataka pokojnika (Bónis 1942: 39) i treba je razlikovati od kuhinjskog posuđa. Lonac za kuhanje (*aula*) mora imati određenu dubinu, može imati poklopac i ručke, jednostavan oblik i određeni kapacitet. Lonci su se izrađivali od keramike, stakla i metala (Hilgers 1969: 39–40, 112–116). Posude koje su služile kao urne i koje su pronađene u grobovima obično su veće od lonaca pronađenih u naseljima (Plesničar-Gec 1977: 79).

Prema Bónis najstariji lonci nose češljasti ukras i on

ceramics, that can only be found in that town.

A large number of ceramics, similar to those found on the Virovitica Kiškorija south site, can be expected in villages and villae rusticae. These ceramics are made by hand, simple and practical, on a low level of technology and fired in badly controlled conditions. Despite that, many examples of organised manufacture of different types of ceramics in villae rusticae are known from the excavations: functional ceramics, construction ceramics, tableware, oil lamps, ceramoplastics, transport ceramics. The ceramics manufactured in places like that may have been designed for the needs of a village, villa rustica or further distribution. Villa rustica with a ceramics workshop, on the site Tâc-Fövenypusta, is a famous example (Thomas 1955: 107, Abb. 3. 67, 122, 123, T. Ll: 17). We should be cautious, because in this case it is not a local manufacture.

The locally produced ceramics are exclusively the ceramics manufactured in a micro region, for the use and sale within that micro region.

There was a continued need for ceramics used for cooking, preparing, serving and storage of food, due to cracks, breakage and recipe requirements. The continuous use weakens the slip, destroys it and makes vessels impossible to wash and remove unpleasant stains and odours. Hence the food remained in the pores of ceramics, making the pot unsuitable for further use. The mortars would also wear out, because the constant grinding of ingredients would use up the pebbles that were used for crushing. The pots for cooking would usually break, because of the frequent use and moving. That is probably the reason why they are the most numerous (Peña 2007: 40–43, 57–58). It was not possible to transfer the locally produced functional ceramics over long distances because of their frailty, and, also it was not profitable because of their low value, so there was a legitimate need for a large number of organised or individual potters, who fulfilled every-day needs for the functional ceramics.

**3.3.1. Pots** (Lat. *aula, olla, urna*, Ger. *Topf, Urnen*, Ital. *olla*, Fr. *pot*)

*Aula/aula, ola/olla* is the terminology used for the Roman kitchenware, used for cooking. It was placed in the fireplace or hanged above it, and it was also utilised for the storage of liquid and solid food. This ceramic object may have also been used for religious purposes. Cremated remains of the deceased were kept in *olla ossuaria* (Bónis 1942: 39), which should be distinguished from the dishes. The cooking pot (*aula*) must be deep enough, it may have a lid and handles, simple shape and certain capacity. Pots were made of ceramic, glass or metal (Hilgers 1969: 39–40, 112–116). Pots which served as urns and which were found in graves, were usually bigger than the ones found in set-

predstavlja keltsku tradiciju te su čest ukras na posudama jugozapadne Panonije i u onom dijelu Panonije koji graniči s Norikom (Bónis 1942: 40).<sup>5</sup> Na Virovitici Kiškorijski jug pronađen je samo jedan primjer češljasto ukrašenog lonca koji je datiran u 3.–4. st. (T. 24: 8, SJ 437/438). Vikić smatra da se analogije za lonce domaće proizvodnje nerijetko nalaze među prapovijesnom latenskom keramikom (Vikić-Belančić 1965: 103). To je logično s obzirom na jaku domaću lončarsku tradiciju posebno u onim naseljima koja su nastavila život iz mlađeg željeznog doba u antiku i u onim slučajevima gdje autohtono stanovništvo nije raseljeno i gdje su oni sačuvali svoje tradicije.

Među uporabnom keramikom lokalne proizvodnje prevladavaju lonci (Vikić 1971: 94; Vikić-Belančić 1975: 27, 33). To je i logično budući da se u kućanstvu najviše koriste, a na taj način i troše pa je potreba za njima najveća što rezultira najvećim brojem nalaza ovog tipa posuda među uporabnom keramikom. Lonci su tipološki i najraznovrsniji. Kao i kod drugih tipova posuda grube strukture, u slučaju lonaca ne može se pratiti razvoj oblika kroz stoljeća, već se može zaključiti kako se ti tipovi pojavljuju od 2.–5. st. (sl. 148). Vrlo su jednostavnog oblika i imaju uporabnu funkciju čemu su i prilagođeni. To se dobro vidi iz keramičkog materijala s lokaliteta Virovitica Kiškorijski jug gdje su isti tipovi lonaca prisutni u objektima datiranim <sup>14</sup>C metodom u 2., 3., 4. i početak 5. stoljeća.

Pregledom materijala uočeno je kako dio lonaca ima mat premaz na vanjskoj stijenci, te na obodu s unutrašnje strane. Kako taj premaz sprječava poroznost posude pretpostavlja se da su lonci koji ga imaju korišteni za kuhanje i čuvanje tekućeg sadržaja, a oni koji ga nemaju za čuvanje krute hrane (žitarice, voće, povrće, meso). Dio lonaca većih dimenzija u svojoj strukturi ima usitnjene ulomke opeka ili keramike (grog) (kat. br. 209, T. 23: 8). Drugu grupu lonaca po strukturi čine lonci koji su tamnosive boje s velikom količinom krupnih primjesa kvarca i tinjca. Ti lonci su kao i prethodni većih dimenzija. Njihova struktura im je omogućavala otpornost na toplinske promjene i udarce te su bili vrlo pogodni za kuhanje i pripremu hrane (Miletić 2007: 351).

Unutar pojedinog tipa lonca postoje izvjesne razlike i odstupanja u oblikovanju, međutim oni imaju glavne zajedničke osobine. Kako svi lonci pojedinog tipa nemaju u potpunosti istovjetna obilježja (zbog činjenice što je većina rađena rukom), to još više otežava pronalaženje analogija na lokalitetima koji su udaljeni, odnosno koji ne čine uski regionalni krug unutar kojeg se upravo ovi tipovi mogu naći (misli se na blizinu Orešca i Virovitice Kiškorijski jug). Regionalnu proizvodnju s distribucijom posuda na malom području za Sloveniju pretpostavlja Plesničar-Gec jer uočava specifične tipove lonaca ograničene na mala područja. Također pretpostavlja vrlo gustu mrežu

tlements (Plesničar-Gec 1977: 79).

According to Bónis, the eldest pots have a combed decoration which represents the Celtic tradition and it is a frequent decoration on pots from the south-western Pannonia and from the border of Pannonia and Noricum (Bónis 1942: 40).<sup>5</sup> Only one example of a pot with a combed decoration from the 3<sup>rd</sup>–the 4<sup>th</sup> century was found on the Virovitica Kiškorijski south site (Pl. 24: 8, SU 437/438). Vikić thinks that the analogies for the locally manufactured pots can be found among the prehistoric La Tène ceramics (Vikić-Belančić 1965: 103). That is logical, considering that there was a strong local pottery tradition, especially in the settlements with continuous existence from the Early Iron Age to the Antiquity and where the inhabitants were not displaced and they kept their traditions.

Pots prevail among the locally produced functional ceramics (Vikić 1971: 94; Vikić-Belančić 1975: 27, 33). Since they were the most used dish in households they would wear out, so they were most needed as well. Consequently, pots are the most numerous finds of the functional ceramics. They are, also, typologically most diverse. The development of pot shapes, as well as with the other types of vessels with coarse fabric, cannot be followed throughout centuries. It can be concluded that these types appear from the 2<sup>nd</sup> to the 5<sup>th</sup> century (fig. 148). They are very simply moulded and adapted for their functional use. This is evident from the ceramic material from the Virovitica Kiškorijski south site, where the same types of pots can be found in objects from the 2<sup>nd</sup>, 3<sup>rd</sup>, 4<sup>th</sup> and the early 5<sup>th</sup> century, according to the <sup>14</sup>C dating method.

It has been noted by the examination of material that some of the pots have a matte slip on the outside wall and on the inside of the rim. The slip prevents the porosity of a vessel, so the pots with a slip were used for cooking and storage of liquid content, while the ones without a slip were used for the storage of solid food (cereals, fruit, vegetables, meat). Some of the bigger pots have chipped fragments of bricks or ceramics (chamotte) in their structure (Cat. No. 209, Pl. 23: 8). Classified by fabric, the other group consists of dark grey pots with a large quantity of large quartz and mica inclusions. These pots are large sized like the previous ones. Their fabric facilitated the thermal shock resistance and impact resistance, they were also suitable for cooking and food preparing (Miletić 2007: 351).

Even though there are certain differences and deviations in moulding within one type of pots, they all have same main features. All the pots of the same type do not have identical features (because they were made by hand), which aggravates the finding of analogies on remote sites, that do not form a narrow regional circle, in which these exact types can be found (proximity of Orešac and Virovitica Kiškorijski south). Plesničar-Gec assumes that there was

5 Jelinčić 2009: T. 22: 099; T. 45: 3; T. 46: 1; T. 48: 1; T. 49: 2; T. 50: 2; T. 57: 1–2; T. 58: 1; T. 65: 6–9; T. 66: 1, 3; T. 69–70; T. 72: 1; T. 75: 4; T. 90: 2; T. 91: 1; T. 102: 1; T. 105: 1–2.

5 Jelinčić 2009: T. 22: 099; T. 45: 3; T. 46: 1; T. 48: 1; T. 49: 2; T. 50: 2; T. 57: 1–2; T. 58: 1; T. 65: 6–9; T. 66: 1, 3; T. 69–70; T. 72: 1; T. 75: 4; T. 90: 2; T. 91: 1; T. 102: 1; T. 105: 1–2.

radioničkih središta koja su osiguravala potrebe lokalnog stanovništva (Plesničar-Gec 1977: 80, 93). Lokalnu proizvodnju grube keramike pretpostavlja i Horvat za Nauport (Horvat 1990: 228).

Lonci grube keramičke strukture izrađeni u jugoistočnom dijelu Gornje Panonije bitno se razlikuju od lonaca jugozapadnog dijela Gornje Panonije, Norika i Donje Panonije (Bónis 1942; 1981).

Prvi tip lonaca **L1** (T. 2: 5–7; T. 4: 6; T. 18: 15; T. 20: 11–12; T. 22: 1–2; T. 23: 8; T. 24: 1–2), (kat. br. 14–16, 30, 176–178, 122, 194–195, 209–211) ima jednostavan oblik, neznatno izvijenog ili nenaglašenog širokog oboda, vrat je vidljiv na prijelazu iz oboda u rame (sl. 139). Obod nije puno širi od trbuha posude. Samo je kat. br. 194 izrađen na kolu, a drugi su lonci rađeni rukom. Obrada rukom jasno se vidi na oblikovanju oboda kat. br. 178, gdje su vidljivi tragovi prstiju lončara. Unatoč postojanju manjih razlika između po-

a regional production with distribution of pots on a small area of Slovenia, because she notices specific types of pots limited on smaller areas. Likewise, she presumes the existence of a dense network of workshops centres, which provided for the needs of the local population (Plesničar-Gec 1977: 80, 93). Horvat presumes that there was a local production of coarse ceramics for Nauportus (Horvat 1990: 228).

Pots with a coarse ceramic fabric, made in the south-eastern part of Upper Pannonia are significantly different from the pots from the south-western part of Upper Pannonia, Noricum and Lower Pannonia (Bónis 1942; 1981).

**L1** is the first type of pots (Pl. 2: 5–7; Pl. 4: 6; Pl. 18: 15; Pl. 20: 11–12; Pl. 22: 1–2; Pl. 23: 8; Pl. 24: 1–2), (Cat. No. 14–16, 30, 176–178, 122, 194–195, 209–211). It has a simple form with a slightly strained or unemphasised wide rim. Its neck is evident on the transition of rim into shoulder (fig. 139). The

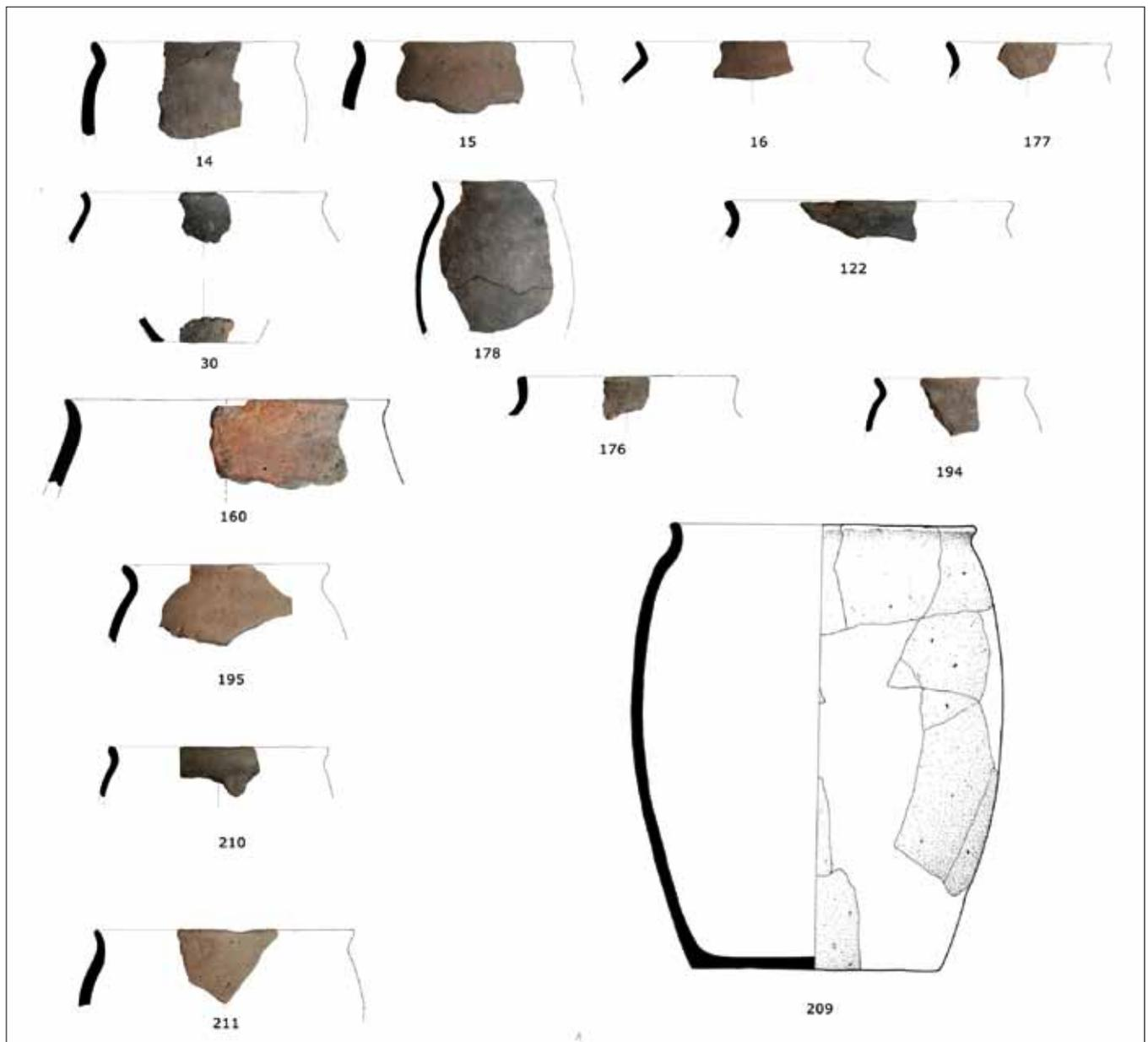

Sl. 139 Lonci tip 1  
Fig. 139 Type 1 pots

suda, one su svrstane u jedan tip zbog glavnih zajedničkih osobina. Kataloški broj 209 (sl. 140, T. 23: 8) u sebi ima primjese mrvljene keramike što je pridonijelo čvrstoći njegove strukture u smislu otpornosti na udarce i temperaturne promjene.

Tip L1 jako podsjeća na prapovijesnu keramiku i moguće je da se taj oblik sačuvao u tradiciji domaćih lončara. Pored oblika, prapovijesna keltsko-panonska tradicija osjeća se u Panoniji u tehnici izrade i u načinu ukrašavanja što je logično s obzirom na jaku prapovijesnu tradiciju izrade keramike, što je i u antici postalo važna privredna grana (Vikić 1971: 94; Vikić-Belančić 1975: 30–31, 33). Prema Plesničar-Gec, kada je u keramici prepoznata prapovijesna tradicija u obliku, to govori u prilog datiranju u 1. ili 2. st. te povezanost stanovništva koje je koristilo taj oblik posude s Keltima (Plesničar-Gec 1977: 79).

Veliki broj ovakvih lonaca pronađen je na lokalitetu Liskovac i datiran je u drugu polovinu 1. st. (Ožanić Roguljić 2009: 89).

Analogije za tip L1 nalaze se u Novom Mestu: grob 116, 136, 137, 181, 182, 187 (Knez 1992: 49, 53, 62, 63, T. 41: 7, 12, T. 49: 6, 8, T. 50: 2, T. 65: 7, T. 66: 2, 13–14), s manjim razlikama u profilaciji, a neki primjerci u Novom Mestu su i ukrašeni kao lonac u grobu 137. U grobu u Topuskom pronađen je ulomak grube kućne keramike domaće proizvodnje analogan tipu L 1 (Šarić 1979–1980: 131, 141, T. VII: 6). Lonci ovakvog tipa iz Ljubljane datirani su u Augustovo (Vičić 1993: 156, 167, T. 1: 14–15) i Tiberijevo vrijeme (Plesničar-Gec 1972: 35, T. XXXVII: 1; Vičić 1994: 34, 41, T. 14: 13). Lonac slične profilacije koji je ukrašen metličastim ukrasom pronađen je u Varaždinskim Toplicama i datiran je u 1. st. po. Kr. (Vikić-Belančić 1972–1973: 104, T. XVI: 4). U rano carski period datiraju se i lonci iz Siska i također se vežu za lokalne domorodačke tradicije (1. i 2. st.). Ovaj tip lonaca u Sisku se javlja i kasnije, međutim u manjem broju (Jelinčić 2009: T. 114: 2–4; T. 115–116; T. 117: 1–2; T. 122: 2–3; T. 123: 1–2). Neki primjerci iz Siska su ukrašeni (Wiewegh 2001: 93, T. IV: 50–51; Vidošević 2003: 16, T. 3: 4–6, T. 4: T. 5: 1–2; Wiewegh 2003: 42, 77; T. III: 9), međutim ima ih i bez ukrasa (Kordić 2001: 23, T. 6: 34–35). Grubi lonci iz Drenja ukrašeni su metličastim ukrasom, a neki od njih svojom profilacijom pripadaju ovom tipu (Drenje 1987: 28, T. 2: 8, 10).

Na lokalitetu Osječnica ima primjeraka sličnih lonaca od grube keramike (Ožanić 1998: 50, T. 19: 1). Također, analogni lonac pronađen je u Ptuju (Vikić-Belančić 1965: 100, sl. 27: 6). U naselju 1. st. po. Kr. Mitrovačke livade kraj Sremske Mitrovice pronađen je ovakav lonac (Brukner 1995b: 146, T. II: 20). U Singidunumu, ovakav tip lonca se datira u 2. st. (Nikolić-Đorđević 2000: 73–74). U Pečuhu je pronađen lonac izrađen od grube strukture koji ima neznatno izvučen obod i nalik je tipu 1. On je datiran u kraj 3. i p. 4. st. (Fülep 1984: 131, 144, 182, 188, sl. 110: 9). Na rimskoj vili na lokalitetu Jalžabet-Bartolovec pronađen je ovakav lonac kojeg Vikić-Belančić veže uz latenske tradicije i datira od sredine

rim is not much wider than the pot's body. Only Cat. No. 194 was moulded on a wheel; the other pots were made by hand. It can be seen that they were made by hand on the example of the moulding of the rim Cat. No. 178, because the potters' fingerprints are visible. Even though there are small differences among these vessels, they are of the same type, for they have the same main characteristics. Catalogue number 209 (fig. 140, Pl. 23: 8) has triturated ceramic inclusions, which made its structure harder - concerning the impact resistance and thermal shock resistance.

The L1 type strongly resembles the prehistoric ceramics. It is possible that this shape was preserved in local potters' tradition. Besides in the shape, the prehistoric Celto-Pannonic tradition can be seen in the production technique and in the style of decorating. That is logical, considering the strong prehistoric tradition of ceramics production and its importance as a branch of economy during the Antiquity (Vikić 1971: 94; Vikić-Belančić 1975: 30–31, 33). According to Plesničar-Gec, the similarities that ceramics have with prehistoric shape traditions, suggest that they are from the 1<sup>st</sup> or the 2<sup>nd</sup> century, and they also suggest a connection between the people who used that shape with the Celts (Plesničar-Gec 1977: 79).

A large number of these pots were found on the Liskovac site and they date to the second half of 1<sup>st</sup> century (Ožanić Roguljić 2009: 89).

There are analogies for the type L1 in Novo Mesto: grave 116, 136, 137, 181, 182, 187 (Knez 1992: 49, 53, 62, 63, T. 41: 7, 12, T. 49: 6, 8, T. 50: 2, T. 65: 7, T. 66: 2, 13–14), with smaller profilation differences. Some of the examples in Novo Mesto are decorated like the pot in grave 137. A fragment of the locally produced coarse home ceramics is analogue to type L1 has been found in a grave from Topusko (Šarić 1979–1980: 131, 141, T. VII: 6). This type of pots from Ljubljana date to the Augustan (Vičić 1993: 156, 167, T. 1: 14–15) or Tiberian Age (Plesničar-Gec 1972: 35, T. XXXVII: 1; Vičić 1994: 34, 41, T. 14: 13). The pot of the similar profilation and with a brushed decoration has been found in Varaždinske Toplice, it dates to the 1<sup>st</sup> century (Vikić-Belančić 1972–1973: 104, T. XVI: 4). Pots from Sisak are also connected with local and native traditions, they date to the early Empire (1<sup>st</sup> and 2<sup>nd</sup> century). This type of pots appears later in Sisak, but in a smaller number (Jelinčić 2009: T. 114: 2–4; T. 115–116; T. 117: 1–2; T. 122: 2–3; T. 123: 1–2). Some examples from Sisak are decorated (Wiewegh 2001: 93, T. IV: 50–51; Vidošević 2003: 16, T. 3: 4–6, T. 4; T. 5: 1–2; Wiewegh 2003: 42, 77; T. III: 9) and some are not (Kordić 2001: 23, T. 6: 34–35). Coarse pots from Drenje have combed decorations and some of them can be attributed to this type by their profilation (Drenje 1987: 28, T. 2: 8, 10).

There are similar examples of the coarse ceramic pots on Osječnica site (Ožanić 1998: 50, T. 19: 1). An analogue pot was found in Ptuj as well (Vikić-Belančić 1965: 100, fig. 27: 6). A pot like this from the 1<sup>st</sup> century was found in



Sl. 140 Lonac tip 1, kat. broj 209, SJ 2149/2150  
Fig. 140 Type 1 pot, Cat. No. 209, SU 2149/2150

1. do sredine 2. stoljeća (Vikić-Belančić 1968b: 85–86, T. V: 5). U Italiji, na lokalitetu Bedriacum ovakav vrlo jednostavan tip lonca, koji je korišten za pripremu hrane, smješta se u razdoblje od 1. st. pr. Kr. do vremena cara Tiberija, a javlja se sporadično i kasnije. Ti su lonci izrađeni s mnogo primjesa, a boja pečenja im varira (Della Porta 1996: 152–153, 181) što je vrlo slično loncima tipa L 1. Na primjeru Bedriakuma koji traje od mlađeg željeznog doba do u kasnu antiku vidimo kako posuđe s prapovijesnim tradicijama kontinuirano traje sve do kasne antike.

Na Virovitičkim Kiškorijskim jug, lonac kat. br. 30 (sl. 139, T. 4: 6) pronađen je u cjelini koja se datira u prvu polovinu 3. st. <sup>14</sup>C datumom. Kat. br. 14 i 15 (T. 2: 5–6), 209 i 210 (T. 23: 8, T. 24: 1) su kontekstom datirani u 2.–3. st. Prema analogijama za ovaj tip vidimo da je uglavnom zastupljen u 1.–2. stoljeću, ali se povremeno javlja i kasnije, do u početak 4. stoljeća (sl. 148). Lonci iz Orešca koji pripadaju ovom tipu datiraju se u kasnu antiku (Jelinčić 2009: T. 28).

Drugi tip lonca **L2** (T. 10: 1–7, T. 16: 2; T. 18: 5, 7, 10; T. 19: 1; T. 20: 13; T. 21: 2, 14; T. 22: 3; T. 24: 3; T. 27: 1), (kat. br. 69–75, 123 154–155, 158, 162, 170, 182, 192, 196, 212, 221 (sl. 141), čine posuđe s izvijenim i blago zaobljenim obodom, vrlo kratkim i jedva naglašenim vratom te zaobljenim rameonom. Unutar tog tipa također postoje odstupanja u visini i naglašenosti ramena i zaobljenosti oboda i samog ruba oboda. Na dva lonca nalaze se utori na obodu s unutrašnje strane koji su služili za bolje prijanjanje poklopca (kat. br. 123 i 162). Dio lonca ima premaz, odnosno tragove pre-

the settlement Mitrovačke livade near Sremska Mitrovica (Brukner 1995b: 146, T. II: 20). These types of pots in Singidunum date to the 2<sup>nd</sup> century (Nikolić-Đorđević 2000: 73–74). A coarse fabric pot that has a slightly protruding rim was found in Pécs. It resembles type 1 and dates from the late 3<sup>rd</sup> to the early 4<sup>th</sup> century (Fülep 1984: 131, 144, 182, 188, sl. 110: 9). This type of pot, that Vikić-Belančić associates with the La Tène traditions and dates it from the mid-1<sup>st</sup> to the mid-2<sup>nd</sup> century, has been found in a Roman villa on Jalžabet-Bartolovec site (Vikić-Belančić 1968b: 85–86, T. V: 5). This simple type of pots which were used for the preparation of food on Bedriacum site in Italy date from the 1<sup>st</sup> century BC to the time of the emperor Tiberius. They can also be found in the later period, but only sporadically. These pots are made with a lot of inclusions and their colour varies (Della Porta 1996: 152–153, 181) which makes them very similar to type L1 pots. Bedriacum is a good example of the continuous existence of pots with prehistoric traditions from the Early Iron age to the late Antiquity.

The pot Cat. No. 30. (fig. 139, Pl. 4: 6) was found on the Virovitica Kiškorijska south site, it is a part of a unit which was dated to the early 3<sup>rd</sup> century using the <sup>14</sup>C method. Cat. No. 14 and 15 (Pl. 2: 5–6), 209 and 210 (Pl. 23: 8, Pl. 24: 1) were dated to the 2<sup>nd</sup>–3<sup>rd</sup> century by its context. This type can be dated by analogies from the 1<sup>st</sup>–2<sup>nd</sup> century, but it can occasionally appear later, until the beginning of the 4<sup>th</sup> century (fig. 148). This type of pots from Orešac dates to the late Antiquity (Jelinčić 2009: T. 28).

The second type of pots - **L2** (Pl. 10: 1–7, Pl. 16: 2; Pl. 18: 5, 7, 10; Pl. 19: 1; Pl. 20: 13; Pl. 21: 2, 14; Pl. 22: 3; Pl. 24: 3; Pl. 27: 1), (Cat. No. 69–75, 123 154–155, 158, 162, 170, 182, 192, 196, 212, 221 (fig. 141) are the vessels with mildly curved and rounded rim, very short and barely emphasized neck and a rounded shoulder. There are some deviations within this type in the height and emphasis of the neck, in the roundness of the rim and in its edge. Two pots have sockets on the inside rim, these sockets served to better fit the lid on the rim (Cat. No. 123 and 162). A part of pots has slip or traces of slip (Cat. No. 71–73, 75, 123, 158).

Pots Cat. Nos. 69–75 were found in the backfills (cut SU 405) that <sup>14</sup>C dated to the second half of the 3<sup>rd</sup> and the 4<sup>th</sup> century. Cat. No. 162 was found in a structure (SU 1363/1364) from around year 429, based on <sup>14</sup>C dating. Cat. No. 212 is from a structure that can be dated by its context to the 2<sup>nd</sup>–the 3<sup>rd</sup> century. The pot Cat. No. 182 was found in a structure (SU 1852/1853) that dates from year 230 to 330, which is determined with 68% accuracy using the <sup>14</sup>C dating method. This means that the L2 type of pots appears in this part of Podravina from the 3<sup>rd</sup> century to the early 5<sup>th</sup> century (fig. 148).

Vikić dates this type of pots to the 2<sup>nd</sup> century and the early 3<sup>rd</sup> century (Vikić 1975: T. 3: 3b), which coincides with the dates from the Virovitica Kiškorijska south site. However,

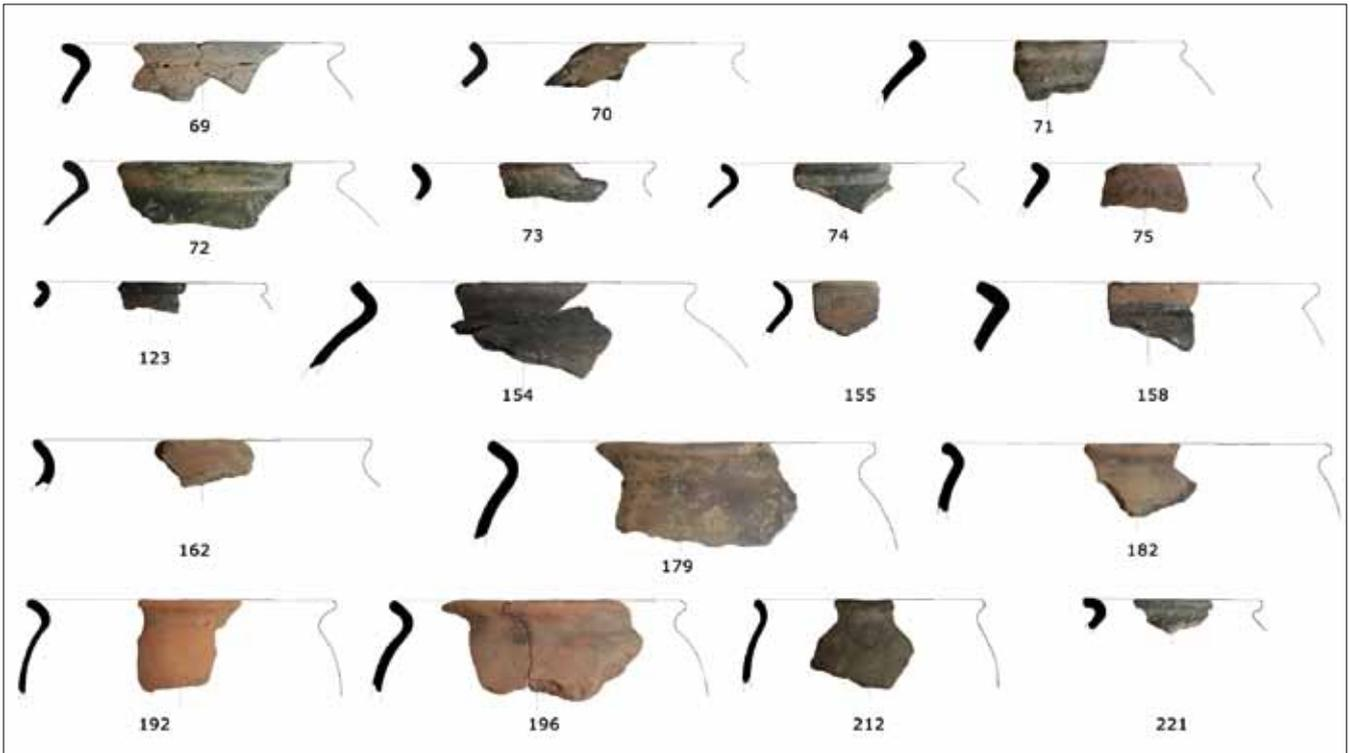

Sl. 141 Lonci tip 2  
Fig. 141 Type 2 pots

maza (kat. br. 71–73, 75, 123, 158).

U drugu polovinu 3. i prvu polovinu 4. st. <sup>14</sup>C datumom datirane su zapune (ukop SJ 405) u kojima su pronađeni lonci kat. br. 69–75. <sup>14</sup>C datumom datiran je i objekt (SJ 1363/1364) u kojem je pronađen kat. br. 162, a datiran je oko 429. g. Kat. br. 212 je iz objekta koji je kontekstom datiran u 2.–3. st. Lonac kat. br. 182 pronađen je u objektu (SJ 1852/1853) koji je <sup>14</sup>C datumom datiran sa 68% točnosti između 230 i 330. g. po. Kr. To bi značilo da se L2 tip lonca u ovom dijelu Podravine javlja od 3. pa do početka 5. stoljeća (sl. 148).

Vikić ovakav tip lonca datira u 2. i početak 3. st. (Vikić 1975: T.3: 3b), što bi se poklapalo s datumima na lokalitetu Virovitica Kiškorija jug, s time što na tom lokalitetu upotreba ovog tipa lonca traje dulje.

Ovakav lonac pronađen je na Jalžabet-Bartolovcu, a osim po tipu sličan je i po tehnologiji izrade. Na njemu se vide još otisci prstiju lončara spoju oboda s tijelom posude. Posuda je rađena rukom, s dodatkom pijeska. Struktura je ipak drugačija od keramike s Virovitice Kiškorije jug u toliko što je keramika iz Jalžabet-Bartolovca tvrđa (Jelinčić 2009: T. 43: 2).

Lonac iz groba 94 iz Stenjevec ima ista obilježja kao i lonci tipa 2, međutim njegova profilacija je znatno blaža. Iz groba 95 je sličan lonac, a on ima i metličasti ukras (Gregl 1989: 27, T. 23: 3/4). Analogije za ovaj tip postoje u Novom Mestu (Knez 1992: 64–65, T. 69: 7), na paljevinskom groblju u Ptuj (Tušek 1993: 390–391, T. 5: 1). Iz tog grada ima još primjeraka ovakvog tipa i datirani su od flavijevskog

the use of this type of pots on this site lasts longer. A pot like this was found on Jalžabet-Bartolovac, and it is similar not only by type but also by the construction technology. Potters' fingertips are still visible on the juncture between the rim and the body of the vessel. The vessel is made by hand and has sand inclusions. The fabric is different from the ceramics on Virovitica Kiškorija south site, because the ceramics from Jalžabet-Bartolovac are harder (Jelinčić 2009: Pl.43: 2).

The pot from the grave 94 from Stenjevec has the same features as type 2 pots, though its profile is much softer. There is a similar pot from the grave 95 and it has a brushed decoration (Gregl 1989: 27, T. 23: 3–4). Analogies for this type can be found in Novo Mesto (Knez 1992: 64–65, T. 69: 7), on the incineration cemetery in Ptuj (Tušek 1993: 390–391, T. 5: 1). There are many more examples of this type from this town which date from the Flavian Times to the first third or the half of the 2<sup>nd</sup> century (Istenić 1999: 137; 2000: 95, 100, 133, T. 55: 10; T. 59: 11; T. 84: 5; Žižek 2004: 131, sl. 47). An urn with a combed decoration was found in grave 108 in *Emona*, which fits this type by the rim and shoulder profile (Plesničar-Gec 1972: 31, T. XXIX: 3), and in an incineration grave a vessel (also an urn) was found that fits Cat. No. 154 by the profile of the rim and the shoulder and has a combed decoration (Plesničar-Gec 1972: 76, T. CIII: 15). This type of pot was found in the Early Empire layer in Sermin (Horvat 1997: T. 11: 14).

Cat. No. 162 has a socket for the lid on the inside wall of the rim, and a pot similar to that one was found on Gomo-

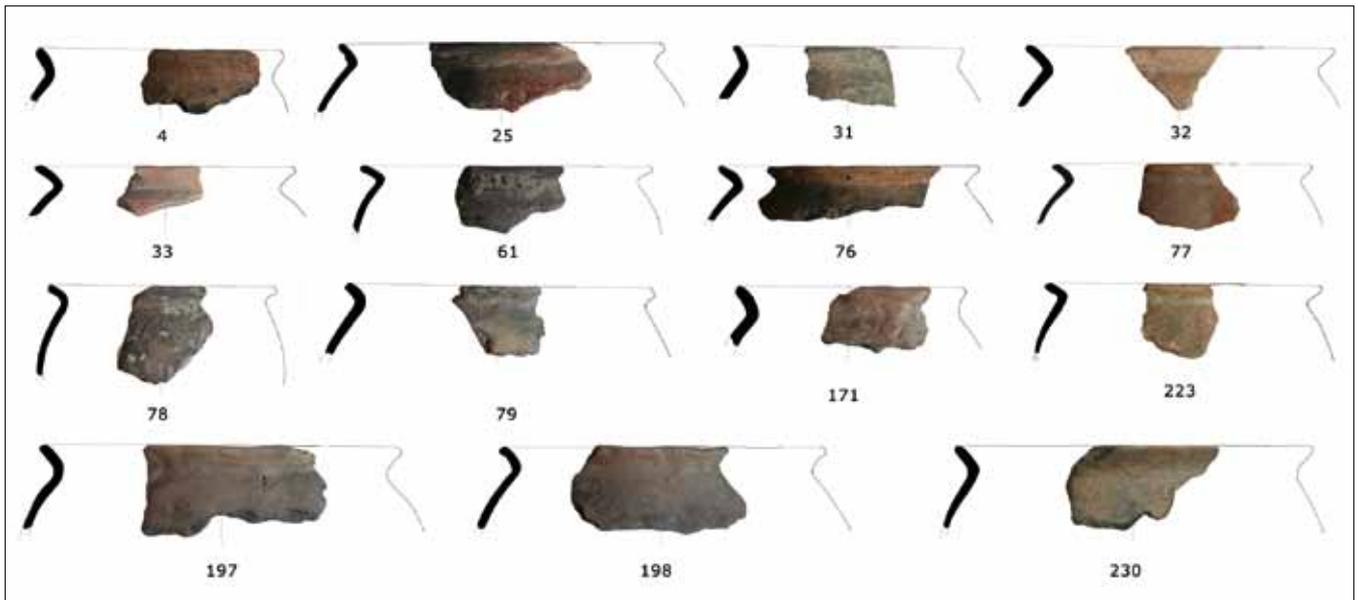

Sl. 142 Lonci tip 3  
Fig. 142 Type 3 pots

vremena do prve trećine ili polovine 2. st. (Istenić 1999: 137; 2000, 95, 100, 133, T. 55: 10; T. 59: 11; T. 84: 5; Žižek 2004: 131, sl. 47). U Emoni je u grobu 108 pronađena urna s metličastim ukrasom koja po profilaciji oboda i ramena odgovara ovom tipu (Plesničar-Gec 1972: 31, T. XXIX: 3), a u paljevinskom grobu 383 (također urna) pronađena je posuda koja profilacijom oboda i ramena odgovara kat. br. 154, te ima metličast ukras (Plesničar-Gec 1972: 76, T. CIII: 15). Ovakav lonac pronađen je u ranocarskom sloju u Serminu (Horvat 1997: T. 11: 14).

Kat. br. 162 ima utor na unutrašnjoj strani oboda za poklopac, a takav je sličan lonac pronađen na Gomolavi gdje se ubraja među lonce koji se ne naslanjaju na lokalne tradicije (Dautova-Ruševljan, Brukner 1992: 26, 33, 50, T. 16: 104). Na lokalitetu Guran – na Križu (Istra) pronađen je lonac zaobljenog oboda i ramena s nešto izraženijim vratom nego što je to slučaj kod lonaca iz Virovitice Kiškorije jug. Lonac iz Gurana također je ukrašen i datiran je u kasnu antiku (Bekić 2007: 36, 54, T. 7: 15). Na lokalitetu Matrica u grobu u kojem je pronađen novac cara Hadrijana pronađen je lonac koji po profilaciji nalikuje kat. br. 158 (Tópal 1981: T. XVIII: grob 54: 2). U Donjoj Panoniji, u Vinkovcima pronađen su lonci koji odgovaraju ovom tipu (Ožanić 2004a: 101, T. 81: 7).

Sukladno analogijama te <sup>14</sup>C datumima vidi se kako i L 2 tip lonca traje od 1. pa do kraja 4. stoljeća (sl. 148).

Treći tip lonca **L3** (T. 1: 4; T. 4: 1, 3, 7–9; T. 9: 1; T. 10: 8–11; T. 20: 3; T. 22: 4–5; T. 27: 6; T. 28: 10), (kat br 4, 25, 31–33, 61, 76–79, 171, 197–198, 223, 230) (sl. 142) ima koso izvijen obod i zaobljeno rame. Samo jedan lonac ima premaz (kat. br. 79). Unutar tipa, pojedini lonci malo se razlikuju, ali imaju glavna zajednička obilježja.

<sup>14</sup>C analizom ugljena kat. br. 77–79 datirani (ukop SJ

lava, where it is considered to be a type which is not a legacy of local traditions (Dautova-Ruševljan, Brukner 1992: 26, 33, 50, T.16: 104). A pot with a curved rim and shoulders with a more prominent neck than the pots from Virovitica Kiškorija south was found on Guran – na Križu in Istria, and it dates to the Late Antiquity (Bekić 2007: 36, 54, T.7: 15). In the grave where the coins of Emperor Hadrian were found, a pot which resembles Cat. No. 158 by profile was found on Matrica site (Tópal 1981: T.XVIII: grave 54: 2). Pots which fit this type were found in Vinkovci, Lower Pannonia (Ožanić 2004a: 101, T.81: 7).

According to the analogies and <sup>14</sup>C dates, L 2 type of pots existed from the 1<sup>st</sup> to the late 4<sup>th</sup> century (fig. 148).

The third type of pots **L3** (Pl. 1: 4; Pl. 4: 1, 3, 7–9; Pl. 9: 1; Pl. 10: 8–11; Pl. 20: 3; Pl. 22: 4–5; Pl. 27: 6; Pl. 28: 10), (Cat. Nos. 4, 25, 31–33, 61, 76–79, 171, 197–198, 223, 230) (fig. 142) has an obliquely curved rim and a rounded shoulder. Only one pot has slip (Cat. No. 79). Individual pots differ within the type, but they have the same main features.

Cat. Nos. 77–79 (cut SU 405) are dated to the turn of the 3<sup>rd</sup> and the 4<sup>th</sup> century using the <sup>14</sup>C coal analysis. Also, Cat. Nos. 31–33 are dated to the first half of the 3<sup>rd</sup> century, using <sup>14</sup>C analysis. Cat. No. 4 can be dated to the Late Antiquity, since it had been found in a structure, in which several fragments of Late Antique green glazed ceramics were found.

This type of pots dates from the 2<sup>nd</sup> to the 4<sup>th</sup> century, determined by context and the use of the <sup>14</sup>C analysis. Analogue examples from Orešac, where they were dated by context, also date to the late Antiquity (Jelinčić 2009: Pl.39).

A complete pot of this shape was found in a Late Antique grave on Radovanci Brdo site and it dates to the 4<sup>th</sup>



405) su u prijelaz 3. na 4. stoljeće. U prvu polovinu 3. st. <sup>14</sup>C analizama datirani su kat. br. 31–33. Kat. br. 4 može se datirati u kasnu antiku, budući da je pronađen u objektu u kojem je pronađeno više ulomaka kasnoantičke zeleno glazirane keramike.

Prema kontekstu i <sup>14</sup>C analizama ovaj tip lonca javlja se od 2 do u 4. st. U kasnu antiku datiraju se i analogni primjerci iz Orešca gdje su datirani kontekstom (Jelinčić 2009: T. 39).

Cijeli lonac ovakvog oblika pronađen je u kasnoantičkom grobu na lokalitetu Radovanci Brdo i datiran je u 4. st. (Sokač-Štimac 1976: 89–90, T. XXXVIII).

Analogije za L3 postoje u Novom Mestu u grobu 131 (Knez 1992: 52, T. 47: 8). Više analogija pronađeno je u Ptuj u unutar peći iz srednjecarskog vremena, s time da su ptujski primjerci izrađeni od dobro pročišćene gline (Strmčnik-Gulić 1993: 484, 486, T. 1: 2, 4; T. 11: 2). U Petoviju ima i drugih primjeraka ovog tipa lonaca pronađenih u grobovima, a datiraju se od 2.-3. ili 4. st. (Istenić 1999: 137; 2000: 134, 141, 178, T. 85: 6; T. 164: 3). Slični lonci pronađeni su na lokalitetu Nauport gdje su određeni kao lokalna specifičnost (Horvat 1990: 228, T. 16: 9). Lonci ovakve profilacije pronađeni su u Sisciji (Kordić 2001: 23, T. 5: 28; Wiewegh 2001: 93, T. III: 41; T. IV: 47), Bobovki (Vikić-Belančić 1965: 99, sl. 26: 2), jedan je pronađen u Emoni u grobu 14, gdje je pronađen i novac Marka Aurelija (Plesničar-Gec 1972: 16, T. IV: 4), zatim su pronađeni u grobovima 188 (lonac) i 190 (urna) gdje su pronađeni s firmama uljanicama te su ukrašeni metličastim ukrasom (Plesničar-Gec 1972: 43, 44, T. LII: 20; T. LIII: 1). U Singidunumu, ovaj tip lonca datiran je u 3. i početak 4. st. (Nikolić-Đorđević 2000: 66–67). U mađarskoj Baranji na lokalitetu Babarc pronađena je posuda koja oblikom podsjeća na ovaj tip lonca. Međutim, on je na tom lokalitetu svrstan u vrčeve iako nema pronađene drške. Također, ta je posuda od pročišćene gline crvene boje pečenja. Za nju se navodi kako je to oblik koji proizlazi iz latenskih posuda i može se datirati u rano 1. st. po. Kr. (Szabó et al. 2007: 122, T. 22: 222). Na Balatonu, na lokalitetu Balatonaligán, pronađene su peći, od kojih je jedna kao i njezin materijal datiran u kasno 4. st. U njoj je pronađen i lonac ovakvog tipa (Bónis 1992–1993: 171, Abb. 16: 5, 176). Takvu profilaciju oboda, s kosim vratom, naglim lomom u vratu i zaobljenim tijelom imaju i lonci s dvije drške koji su svrstani kao 5. tip lonca te je moguće da neki od lonca koji su svrstani u ovaj tip pripadaju 5. tipu lonca, budući da nisu sačuvani u potpunosti, odnosno nije sačuvan prijelaz oboda u dršku što je obilježje tipa 5.

Analogni lonci, slične tehnologije, pronađeni su u kasnoantičkom sloju na rimskoj vili na lokalitetu Jalžabet-Bartolovec (Vikić-Belančić 1968b: 93–94). Oni su rađeni rukom, a obod nije dobro slijepljen s vratom, još su vidljivi tragovi prstiju i spojeva gline s oboda i vrata. U Ludbregu je također zastupljen ovaj tip lonca i datira se u kasnu antiku (Vikić-Belančić 1983–1984: 157, T. 11: 9). Njihova je

century (Sokač-Štimac 1976: 89–90, T. XXXVIII).

There are analogies for the L3 type in the grave 131 in Novo Mesto (Knez 1992: 52, T. 47: 8). More analogies have been found in Ptuj, inside a kiln from the middle Empire. The examples from Ptuj are made of well refined clay (Strmčnik-Gulić 1993: 484, 486, T. 1: 2, 4; T. 11: 2). Other examples of this type of pots are in graves in Poetovium, which date from the 2<sup>nd</sup>- the 3<sup>rd</sup> or to the 4<sup>th</sup> century (Istenić 1999: 137; 2000: 134, 141, 178, T. 85: 6; T. 164: 3). Similar pots which were marked as a local specificity were found on Nauport site (Horvat 1990: 228, T. 16: 9). Pots profiled in this way were found in *Siscia* (Kordić 2001: 23, T. 5: 28; Wiewegh 2001: 93, T. III: 41; T. IV: 47), Bobovka (Vikić-Belančić 1965: 99, sl. 26: 2) and one was found in the grave 14 in *Emona*, where the coins of emperor Marcus Aurelius were found (Plesničar-Gec 1972: 16, T. IV: 4). The ones with brushed decoration were found in the grave 188 (a pot) and 190 (an urn), where Firmalapen were found as well (Plesničar-Gec 1972: 43, 44, T. LII: 20; T. LIII: 1). This type of pots in *Singidunum* dates to the 3<sup>rd</sup> and the early 4<sup>th</sup> century (Nikolić-Đorđević 2000: 66–67). A vessel that resembles this type of pots was found in the Hungarian part of Baranja, on Babarc site. However, it was categorised as a jug on that site, even though there were no handles found. This vessel is made of purified clay in the red firing colour. It is stated that its shape derives from the La Tène vessels and that it can be dated to the early 1<sup>st</sup> century (Szabó et al. 2007: 122, T. 22: 222). Kilns were found on Balatonaligán site, on Balaton; one of them and its material dates to the late 4<sup>th</sup> century. A pot of this type has been found in that kiln (Bónis 1992–1993: 171, Abb. 16: 5, 176). Pots with two handles that are classified as type 5 pots also have a rim profiled in that way with an oblique neck, an immediate fracture of the neck and a round body so it is possible that some of the pots that are classified as this type belong to the type 5, since they are not fully preserved. More precisely, the transition from the rim into the handle is not preserved, which is the characteristic of the type 5.

Analogue pots of similar technology were found in the Late Antique layer in a Roman villa on Jalžabet-Bartolovec site (Vikić-Belančić 1968b: 93–94). They are made by hand and their rim is not well connected to the neck. Fingertips and clay connections on the rim and neck are still visible. This type of pots is also represented in Ludbreg and dates to the Late Antiquity (Vikić-Belančić 1983–1984: 157, T. 11: 9). Their surface is rough and there is a large quantity of milky quartz inclusions in their structure. They are structurally very different from pots from Orešac and Virovitica Kiškorija south and besides that their profile is sharper than the profile of pots from Orešac and Virovitica Kiškorija south (Jelinčić 2009).

The fourth type of pots **L4** (Pl. 1: 5–6; Pl. 2: 1; Pl. 4: 10–13; Pl. 8: 6; Pl. 9: 11a–b; Pl. 10: 12; Pl. 16: 6, 7; Pl. 21: 16; Pl. 27: 2; Pl. 28: 1), (5–6, 11, 34–37, 53, 67, 80, 127, 128, 193, 221, 224),

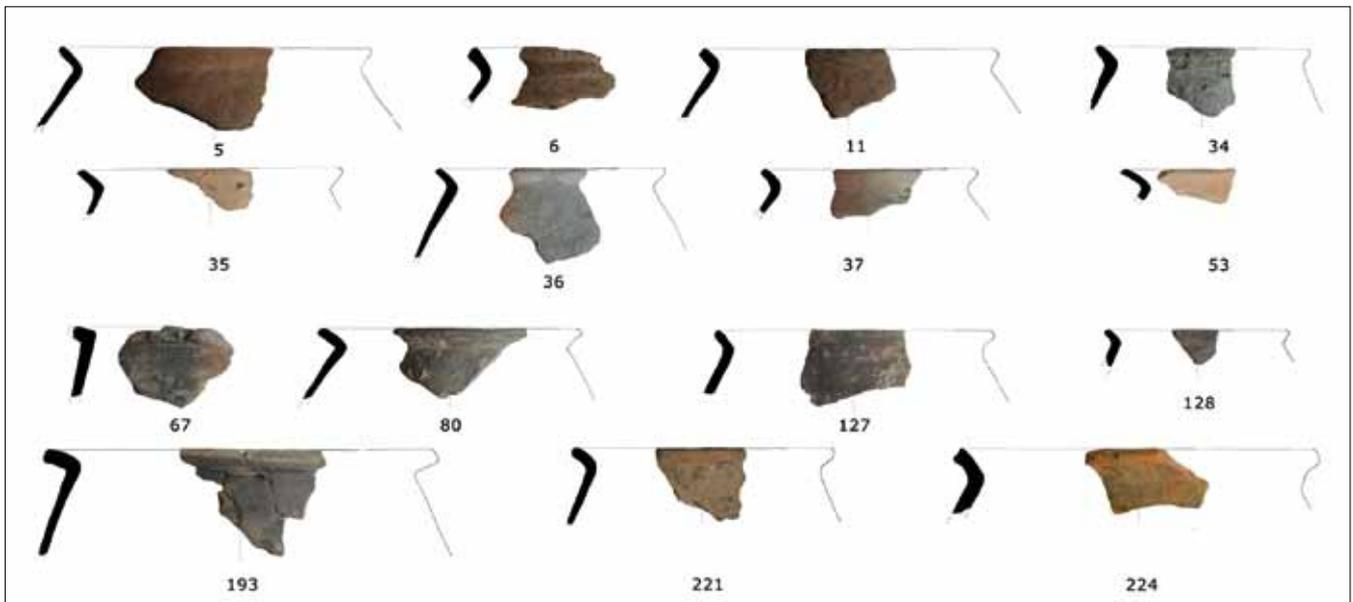

Sl. 143 Lonci tip 4  
Fig. 143 Type 4 pots

površina jako hrapava i u strukturi imaju mnogo primjesa mliječnog kvarca. Strukturalno se jako razlikuju od lonaca iz Orešca i Virovitice Kiškorije jug, a pored toga i njihova je profilacija oštija od lonaca iz Orešca i Virovitice Kiškorije jug (Jelinčić 2009).

Četvrti tip lonaca **L4** (T. 1: 5–6; T. 2: 1; T. 4: 10–13; T. 8: 6; T. 9: 11a–b; T. 10: 12; T. 16: 6, 7; T. 21: 16; T. 27: 2; T. 28: 1), (5–6, 11, 34–37, 53, 67, 80, 127, 128, 193, 221, 224), (sl. 143) razlikuje se od trećeg po oblikovanju ramena. Lonci ovog tipa imaju koso izvijen obod, neznatno naglašen i kratak vrat, a rame je koso oblikovano. Od lonaca koji pripadaju ovom tipu samo jedan ima premaz, a svi ostali ga nemaju. Svi su rađeni rukom, bez kola. Tip L4 je zastupljen i u susjednom Orešču. Tehnološki je istovrsne izrade kao i lonci L 4 tipa s Virovitice Kiškorije jug.

Ovakvo oštra profilacija i nagli prijelaz oboda u rame, gotovo bez vrata, podsjeća na metalne posude pa je moguće da se tu radi o imitaciji tih metalnih posuda. Takvi su metalni kotlići pronađeni u Nauportu (Horvat 1990: T. 32: 1–5), veći broj ovakvih kotlića nalazi se u Arheološkom muzeju u Zagrebu, a potječu iz Siska.<sup>6</sup> Jedan je lonac pronađen u Sremskoj Rači gdje ga autor povezuje s kasno-latenskim tradicijama i ranom datacijom (Milošević 1987: 20, 71, T. 4: 5). U sredinu drugog stoljeća datiran je lonac ovakve profilacije u paljevinskom grobu u Akvinku (Topál 1993: 43, Pl. 62: grob 97: 4).

U prvu polovinu 3. st. datirani su kat. br. 34–37. <sup>14</sup>C datumi odredili su vrijeme trajanja za kat. br. 127, 128 (sl. 148) u početak 3. st. U prijelaz 3. na 4. st. datiran je <sup>14</sup>C datum kat. br. 80. Kat. br. 5 pronađen je u objektu koji je zeleno glaziranom kasnoantičkom keramikom datiran u 3.–4. stoljeća .

(fig. 143) is different from the third type in the moulding of the shoulder. This type of pots has an obliquely curved rim, a slightly prominent and short neck and an obliquely formed shoulder. Only one pot of this type has slip, all the others do not have slip. They are all made by hand, without the wheel. The type L4 is also present in the neighbouring Orešac. It is technologically produced in the same way as type 4 pots from Virovitica Kiškorija south.

Such sharp profilation and the immediate transition of the rim into the shoulder, almost without a neck, resembles to metal pots, so it is possible that this might be an imitation of metal vessels. This kind of metal kettles was found in Nauport (Horvat 1990: T. 32: 1–5). A large number of these kettles from Sisak is stored in the Archaeological Museum in Zagreb.<sup>6</sup> One of the pots was found in Sremska Rača and it is connected by the author to the late La Tène traditions and early dates (Milošević 1987: 20, 71, Pl. 4: 5). A pot of this profile from an incineration grave in *Aquincum* dates to the second half of the 2<sup>nd</sup> century (Topál 1993: 43, Pl. 62: grave 97: 4).

Cat. Nos. 34–37 date to the first half of the 3<sup>rd</sup> century. The <sup>14</sup>C dates determined the dating for Cat. Nos. 127, 128 (fig. 148) to the beginning of the 3<sup>rd</sup> century and for Cat. No. 80, using the same method, to the turn of the 3<sup>rd</sup> and the 4<sup>th</sup> century. Cat. No. 5 was found in a structure which dates to the 3<sup>rd</sup>–the 4<sup>th</sup> century, according to the late Antique green glazed ceramics.

There are also analogies on Blizna site (Bekić 2006: 142, T. 22: 1–3, 7). This type of pots is, by moulding and the sharpness of profilation, like all the other material from this area, similar to pots from sites Ludbreg, Varaždinske Topli-

6 Zahvaljujem dr. sc. Zoranu Greglu što mi je omogućio uvid u građu.

6 I would like to thank Zoranu Gregl PhD for enabling me acces to the museum collection.

Analogije postoje na lokalitetu Blizna (Bekić 2006: 142, T. 22: 1–3, 7). Lonci ovog tipa po izradi su i oštiri profilacije kao i drugi materijal s ovog područja srodni loncima s lokaliteta Ludbreg, Varaždinske Toplice, Petrijanec, Jalžabet (Jelinčić 2009: T. 43: 1; T. 54–55; T. 61: 1), postoje analogni oblici i na Šepkovići (Jelinčić 2009: T. 84: 4; T. 85: 1–2).

U peći iz srednje-carskog vremena u Petoviju, pronađeni su ulomci lonaca analogni tipu 4 od dobro pročišćene gline (Strmčnik-Gulić 1993: 484, 486, T. 1: 7–8). Slični lonci pronađeni su u Nauportu s određenim lokalnim karakteristikama. Oni su međutim ukrašeni metličastim ukrasom (Horvat 1990: 228, T. 17: 5, T. 26: 3). U Sisciji su pronađeni lonci analogne profilacije, ukrašeni na različite načine (Wiewegh 2001: 93, T. III: 35, 37), ali ima i primjeraka bez ukrasa (Kordić 2001: 23, T. 5: 26). Analogni lonac vrlo grube fakture pronađen je u Hrvatskoj Dubici na lokalitetu Kombinac. S istog lokaliteta je i lonac od sive keramike analogan kat. br. 34 (Koščević, Makjanić 1986: 124, sl. 3: 6; sl. 4: 1). Na antičkom groblju u Stenjevcu također je pronađen ovakav tip lonca (Gregl 1989: 19, T. 5: Grob 17: 2). Ovaj tip lonca sreće se u Sirmiju (Parović-Pešikan 1971: 36, T. 77: 3; 1973: 26, T. XX: 9). Na Gomolavi ovaj je tip lonca ukrašen i opredijeljen u nalaze domorodačke tradicije te datiran u 1. st. po. Kr. (Dautova-Ruševljan, Brukner, 1992: 26, 33–34, T. 19: 122, 124). Na lokalitetu Tekija pronađeno je 14 primjeraka lonaca ovoga tipa, a na dunavskom limesu datirani su u 3.–4. st. Sami rub oboda je na tom lokalitetu vertikalno odrezan (Cermanović-Kuzmanović 2004: 133, kat. 57). U okolici Keszthelya, na lokalitetu Tótvázsony (groblje), pronađen je lonac ovakve profilacije oboda i ramena koji je datiran u sredinu 4. st. (Sagí 1960: 206, sl. 20: 1). Ovakvi lonci u kasnoj antici nalaze se u Savariji (Ottományi, Sosztarits 1998: 210, T. II: 8) te u naselju nedaleko od Savarije koje je datirano u 4. i početak 5. st. (Medgyes 2002: 116, T. IX: 281, 404, 186, 2). U Joviji su pronađeni lonci ovog tipa s nešto izraženijom profilacijom (Jelinčić 2009: T. 54–55; T. 61: 1). Struktura lonaca ovog tipa iz Jovije jako se razlikuje. Oni su sivo pečene boje s primjesama kvarca (Vikić-Belančić 1983–1984: T. 11, 13). U Donjoj Panoniji, na lokalitetu Babarc u mađarskoj Baranji, pronađen je lonac koji je oblikom analogan loncima ovog tipa, a izrađen je od sive keramike s premazom (Szabó et. al. 2007: 117, T. 19: 147) i na Dumbovu gdje je datiran od 2. do 4. stoljeća (Brukner 1981: T. 120: 116). U kasnoantičkom kontekstu ovaj tip lonca sa sličnim tehnološkim karakteristikama pronađen je i na rustičnoj vili Jalžabet-Bartolovec (Vikić-Belančić 1968b: 93–94).

Peti tip lonca **L5** (T. 1: 1; T. 8: 1–3; T. 9: 2; T. 10: 13–16; T. 15: 6–8) ima dvije drške (kat. br. 1, 48–50, 81–84 (?), 114 (?), 115 (?)) (sl. 144). Profilacija ovog tipa lonca nalik je tipu L 2 budući da ovi lonci imaju zaobljen obod i zaobljeno rame. Trbuh ovog tipa lonca je zaobljen, a posuda ima najveću širinu u središnjem dijelu posude. Drške posude se od oboda izdižu iznad njega te se spajaju s trbuhom posude u srednjem ili donjem dijelu trbuha. Drške su vrlo blago

ce, Petrijanec, Jalžabet (Jelinčić 2009: T. 43: 1; T. 54–55; T. 61: 1). There are also analogue forms on Šepkovića (Jelinčić 2009: T. 84: 4; T. 85: 1–2).

Fragments of pots, made from a well refined clay, analogue to type 4 were found in a kiln from the middle Empire period, in *Poetovium* (Strmčnik-Gulić 1993: 484, 486, T. 1: 7–8). Similar pots with certain local characteristics were found in Nauport. However, they have a brushed decoration (Horvat 1990: 228, T. 17: 5, T. 26: 3). Pots with analogue profilation were found in *Siscia*, but they have different decorations (Wiewegh 2001: 93, T. III: 35, 37) and some of them do not have any decoration at all (Kordić 2001: 23, T. 5: 26). An analogue pot with coarse fabric was found on Kombinac site, in Hrvatska Dubica. A grey ceramics pot analogue to Cat. No. 34 was found on that same site (Koščević, Makjanić 1986: 124, sl. 3: 6; sl. 4: 1). The same type of pot was found on the Antique cemetery in Stenjevec (Gregl 1989: 19, T. 5: Grave 17: 2). This type of pots can be found in *Sirmium* (Parović-Pešikan 1971: 36, T. 77: 3; 1973: 26, T. XX: 9). On Gomolava, this type of pots is decorated and attributed to the native traditions, and it is dated to the 1<sup>st</sup> century (Dautova-Ruševljan, Brukner, 1992: 26, 33–34, T. 19: 122, 124). Fourteen examples of this type of pots were found on Tekija site and they were dated, on the Danube Limes, to the 3<sup>rd</sup>–the 4<sup>th</sup> century. The very edge of the rim is vertically cut on samples from that site (Cermanović-Kuzmanović 2004: 133, kat. 57). A pot with this kind of rim and shoulder profilation was found in the surroundings of Keszthely, on the Tótvázsony (cemetery) site, and dates to the mid- 4<sup>th</sup> century (Sagí 1960: 206, sl. 20: 1). These pots can be found in Savaria during the Late Antiquity (Ottományi, Sosztarits 1998: 210, T. II: 8) and in a settlement near Savaria which dates to the 4<sup>th</sup> and the early 5<sup>th</sup> century (Medgyes 2002: 116, T. IX: 281, 404, 186, 2). This type of pots with a more prominent profilation was found in *Iovia* (Jelinčić 2009: T. 54–55; T. 61: 1). The fabric of these pots from Iovia is very different. Their firing colour is grey and they contain quartz inclusions (Vikić-Belančić 1983–1984: T. 11, 13). In Lower Pannonia, on Babarc site in the Hungarian part of Baranja, a pot was found that has a shape analogue to this type of pots. It is made from grey ceramics with slip (Szabó et. al. 2007: 117, Pl. 19: 147), one was also found on Dumbov, where it dates from the 2<sup>nd</sup> to the 4<sup>th</sup> century (Brukner 1981: T. 120: 116). In a Late Antique context, this type of pots with similar technological characteristics was also found in villa rustica Jalžabet-Bartolovec (Vikić-Belančić 1968b: 93–94).

The fifth type of pots **L5** (Pl. 1: 1; Pl. 8: 1–3; Pl. 9: 2; Pl. 10: 13–16; Pl. 15: 6–8) has two handles (Cat. No. 1, 48–50, 81–84 (?), 114 (?), 115 (?)) (fig. 144). The profilation of this type of pots is similar to the L 2 type, since these pots also have a rounded rim and a rounded shoulder. Its body is rounded and the vessel is the widest in its middle part. Vessel's handles raise from the rim and go above it, then connect with the vessel's body in the middle or the lower

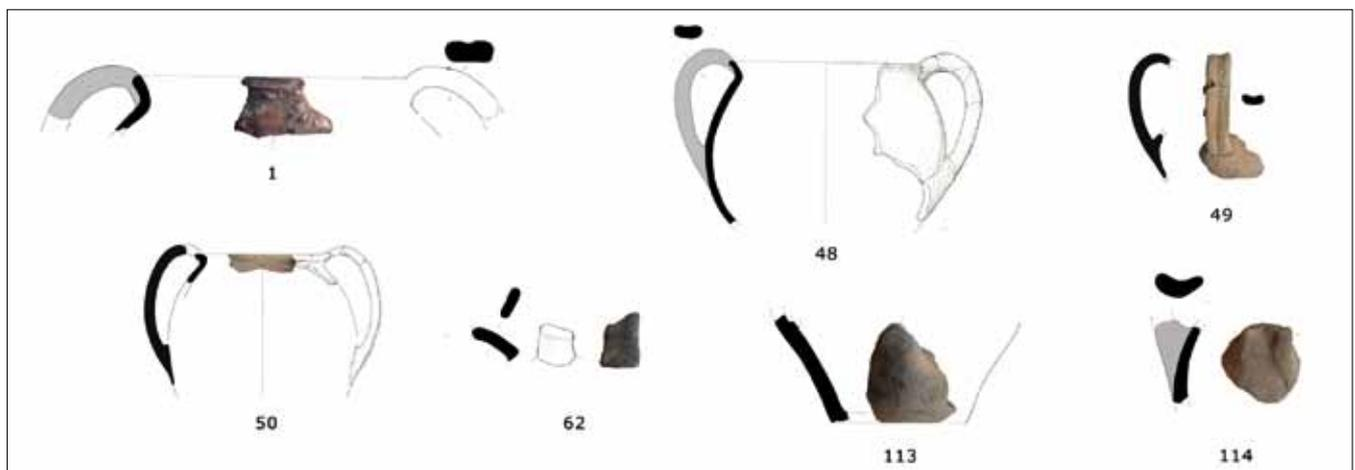

Sl. 144 Lonci tip 5  
Fig. 144 Type 5 pots

profilirane. Na loncima nema tragova premaza. U Orešču je pronađen ulomak posude koji možda pripada ovom tipu lonca (Jelinčić 2009: kat. br. 166).

Slične posude pronađene su na nekropoli Radovanci brdo i datiran je u 4. st. (Sokač-Štimac 1976: 89–90, T. XXXVIII). Analogni su VKJ 2 strukturi, obliku tijela, a razlikuju se u tome što imaju jednu ručku.<sup>7</sup>

Na kasnoantičkom groblju Szentlászló–Szentegyedpuszta javlja se lonac slične profilacije, ali samo s jednom drškom gdje je okarakterizirana kao tipična rimska provincijska keramika (Dombay 1957: 327, T. 35: 6–7). Analogije za ovaj tip lonca izostaju. Moguće da je to zbog fragmentiranosti nalaza odnosno krhkosti ove vrste keramike gdje je teško za ovakav tip utvrditi radi li se o loncu s drškom/drškama ili o običnom loncu. Postavlja se pitanje obrađenosti i objavljenosti ove vrste keramike, a svakako je moguće da se radi i o lokalnoj varijanti koja je zastupljena u većem broju samo u ovom području.

Lonci koji pripadaju ovom tipu pronađeni su u jami zajedno s kasnoantičkom staklenom neprozirnom narukvicom koja je datirana u 3.–4. st. te se na temelju toga, za sada, ovaj tip datira samo u kasnu antiku (sl. 148).

Šesti tip **L6** (T. 24: 8) čini lonac velikih dimenzija (kat. br. 215), vrlo grube fature s dosta krupnih primjesa kvarca tinjca (sl. 145). Zbog svog sastava (pijesak, tinjac) površina je vrlo sjajna. Površina je ukrašena plitko izvedenim češljastim ukrasom i nema premaza, a ukras je vrlo nježno izveden i jedva je vidljiv. Obod posude izvijen je prema van te je rub oboda zadebljan. Posuda ima vrlo blagu S profilaciju, rame je jedva naglašeno, a trbuh ne prelazi širinu oboda. Zbog svojih strukturalnih karakteristika lonac je vjerojatno služio za kuhanje.

Posuda je pronađena u jami koja je datirana <sup>14</sup>C datumom u kraj 3. i početak 4. st. (sl. 148).

Lonci koji imaju obod trokutastog presjeka datiraju se

part of the body. Handles are mildly profiled. There are no traces of slip on the pots. A fragment of a vessel was found in Orešac, which may belong to this type of pots (Jelinčić 2009: kat. br. 166).

Similar vessels were found on the Radovanci brdo necropolis and they date to the 4th century (Sokač-Štimac 1976: 89–90, T. XXXVIII). They are analogue to the VKJ 2 fabric and body shape, and different from it because they have one handle.<sup>7</sup>

A pot with a similar profilation can be found in the late Antique cemetery Szentlászló–Szentegyedpuszta, but it has only one handle. It is characterised as the typical Roman provincial pottery (Dombay 1957: 327, T. 35: 6–7). There are no analogies for this type of pots. Possibly, it is because of the fragmentation of the findings or the fragility of this type of ceramics which makes it hard to determine if a pot had a handle/handles or not. It rises the question of whether this type of ceramics is enough interpreted and published, but it is definitely possible that this type is local and can solely be found in this area.

Pots of this type were found in a pit, together with a late Antique opaque glass bracelet which dates to the 3<sup>rd</sup>–4<sup>th</sup> century. For now, based on that, this type dates only to the Late Antiquity (fig. 148).

The sixth type, **L6** (Pl. 24: 8), is a large pot (Cat. No. 215), made of coarse fabric with a considerable quantity of larger quartz and mica inclusions (fig. 145). Because of its composition (sand, mica), the surface is very glossy. The surface has a shallowly derived combed decoration and it has no slip. The decoration is gently engraved and barely visible. Vessel's rim is curved outward and the edge of a rim is thickened. The vessel has a light S-profilation, its shoulder is hardly emphasised and body does not surpass the width of the rim. According to the characteristics of its fabric, the pot was probably used for cooking.

7 Zahvaljujem se M. Pavličić, kustosici Gradskog muzeja Požege na uvidu u keramički materijal.

7 I would like to thank M. Pavličić, custodian in the Town Museum of Požega, for the insight into ceramic material.

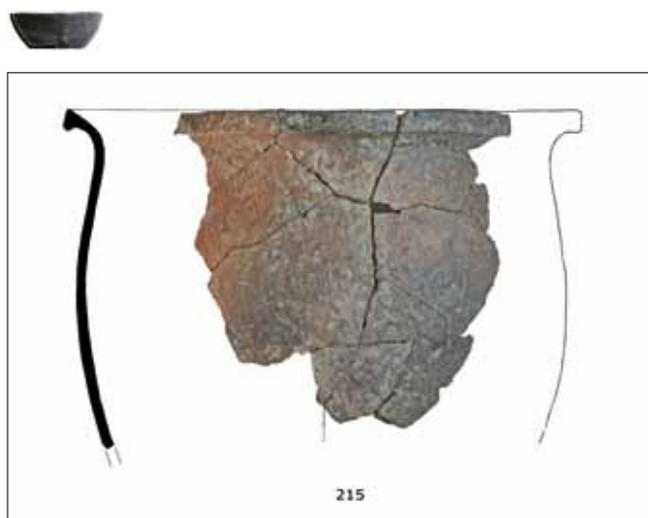

Sl. 145 Lonac tip 6  
Fig. 145 Type 6 pot

u 1. i 2. stoljeće (Petznek 1997 (1998): 203–204), međutim njihov trbuh širi je od oboda što nije slučaj s L 6 tipom.

Ulomak sličnog lonca iz paljevinskog groba 150 u Emoni datiran je ranije od primjerka iz Virovitice Kiškorija jug kontekstom nalaza (Plesničar-Gec 1972: 37, T. XLI: 16). Imaju isto oblikovanje oboda i ramena i metličasti ukras. Kod primjerka iz Emone taj je ukras primijenjen i na unutrašnjoj stijenci.

Sedmi tip lonca **L7** (T. 20: 1 kat. br. 169) razlikuje se od prethodnih tipova prvenstveno po oblikovanju oboda (sl. 146). Obod je malo izvijen prema van, na rubu je znatno proširen i profiliran s 4 koncentrične kružnice. Vrat je kratak i jedva naglašen. Lonac ima premaz na unutrašnjoj i vanjskoj stijenci.

Lonci analognog oboda pronađeni su u gore spomenutoj peći u Petoviju i oni pored profiliranog oboda imaju sitna rebra na ramenu i trbuhu (Strmčnik-Gulić 1993: 484, 486, T. 4: 3–4). Lonci koji imaju ovakav profil oboda, ali bez urezanih koncentričnih kružnica pronađeni su u velikom broju u Gerulati te su datirani u drugu polovinu 1. i u 2. st. (Kreković 1998: 32). Nedaleko od rimskog naselja Flavija Solva (Norik), kod Gleisdorfa, lonci ovakve profilacije datirani su u prvo razdoblje života tj. od sredine 1. st. do sredine 2. st. (Jeschek 2000: 84).

Prema analogijama, ovaj tip se može datirati od 1.–4. stoljeća (sl. 148).

Osmi tip **L8** (T. 2: 2; T. 4: 4; T. 8: 4–5; T. 21: 3; T. 25: 1) većih je dimenzija (kat. br. 12, 28, 51–52, 183, 216) i širokog oboda (sl. 147). Obod lonca izvijen je prema van i s koso odrezanim rubom, vrat nije naglašen, a tijelo se koso širi prema trbuhu posude. Na prijelazu iz vrata u rame nalazi se vodoravna urezana linija. Površina lonca je gruba i hrapava, a u strukturi se nalaze krupne primjese kvarca i tinjca. Zbog tih strukturalnih obilježja ovaj je tip mogao služiti za kuhanje.

Na Virovitici Kiškoriji jug ovaj tip lonca pronađen je u cjelini koja je <sup>14</sup>C datumom datirana u prijelaz 3. na 4. stoljeće. U kasnu antiku, točnije u 4.–5. stoljeće tip L 8 datiran je u kasnoantičkom naselju Tokorcs kod Savarie

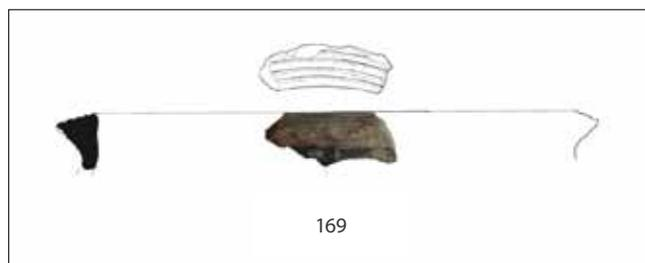

Sl. 146 Lonac tip 7  
Fig. 146 Type 7 pot

The vessel was found in a pit that dates to the late 3<sup>rd</sup> and the early 4<sup>th</sup> century, based on <sup>14</sup>C dating (fig.148).

Pots with a triangular cross-section of the rim date to the 1<sup>st</sup> and the 2<sup>nd</sup> century (Petznek 1997 (1998): 203–204), however their body is wider than the rim which is not the case for the L 6 type.

A fragment of a similar pot from the incineration burial 150 in Emona is dated earlier, by the context of the finds, than the example from Virovitica Kiškorija south (Plesničar-Gec 1972: 37, T. XLI: 16). Their rims, shoulders and brushed decorations are moulded in the same way. The examples from *Emona* has a brushed decoration on the inside wall as well.

The seventh type of pots, **L7** (Pl. 20: 1 Cat. No. 169), is different from the previous types mainly in the way the rim was moulded (fig. 146). The rim is lightly curved outward, it is notably thickened on the edge and profiled with four concentric circles. The neck is short and barely emphasised. The pot has slip on the inner and on the outer wall.

Pots with an analogue rim were found in the previously mentioned kiln in *Poetovium*. Beside the profiled rim, they have small ribs on the neck and the body (Strmčnik-Gulić 1993: 484, 486, T. 4: 3/4). A large number of pots with this kind of rim profilation, but without the engraved concentric circles, were found in *Gerulata* and they date to the second half of the 1<sup>st</sup> and the 2<sup>nd</sup> century (Kreković 1998: 32). In the vicinity of the Roman settlement of *Flavia Solva (Noricum)*, near Gleisdorf, pots with this profilation date to the first period of its life, i.e. from the mid- 1<sup>st</sup> century to the mid- 2<sup>nd</sup> century (Jeschek 2000: 84).

By analogies, this type can be dated to the 1<sup>st</sup>–the 4<sup>th</sup> century (fig. 148).

The eight type, **L8** (Pl. 2: 2; Pl. 4: 4; Pl. 8: 4–5; Pl. 21: 3; Pl. 25: 1), is larger in size (Cat. Nos. 12, 28, 51–52, 183, 216) and has a wide rim (fig. 147). The pot's rim is curved outward and it has an obliquely truncated edge. The neck is not emphasised and the body expands obliquely towards the middle. There is a curved horizontal line in transition of the neck into the shoulder. The surface of the pot is coarse and rough, and in its fabric there are large quartz and mica inclusions. Because of these features of the fabric, this type might have been used for cooking.

On Virovitica Kiškorija south, this type of pots was found as a part of a unit that is dated to the turn of the 3<sup>rd</sup>

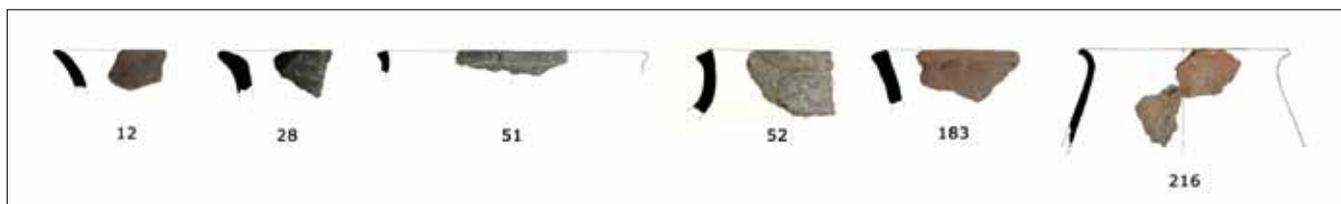

Sl. 147 Lonci tip 8  
Fig. 147 Type 8 pots

(Medgyes 2002: 116, T. IV: 134).

Na lokalitetu Zukve, kod Sv. Ivana Žabnog, pronađen je ulomak lonca ovakve profilacije i ukrasa, međutim, taj je lonac izrađen bez primjese kvarca i tinjca (Tkalčec et al. 2007: 8, T. 5: 1).

Lonci s Virovitice Kiškorije jug pokazuju tipološku i tehnološku srodnost s loncima s Orešca. Makroskopski gledano, struktura većine lonaca s ta dva lokaliteta je slična. Ipak, jesu li oni izrađeni od iste sirovine može se dokazati samo geokemijskim analizama, na način da se usporede strukture s ta dva lokaliteta i više uzoraka gline s oba lokaliteta. Tipovi L1, L3 i L4 javljaju se na Jalžabet-Bartolovcu, Joviji, Petrijancu, a L3 i na kasnoantičkoj nekropolo Radovanci Brdo. Pregledom materijala iz Andautonije uočeno je kako su lonci s tog lokaliteta bitno drukčiji. Oni se tipološki jako razlikuju u tome što su njihovi obodi jače izvijeni, rame

and the 4<sup>th</sup> century, based on <sup>14</sup>C dating. The L 8 type from Late Antique settlement of Tokorcs, near Savarie, dates to the Late Antiquity, more precisely to the 4<sup>th</sup>–the 5<sup>th</sup> century (Medgyes 2002: 116, T. IV: 134).

A fragment with this type of profilation and decoration was found on Zukve site, near Sv. Ivan Žabni. However, that pot was made without quartz or mica inclusions (Tkalčec et al. 2007: 8, T. 5: 1).

Pots from Virovitica Kiškorija south have typological and technological similarities with pots from Orešac. Macroscopically, most of the pots from those two sites have a similar fabric. Still, it can only be determined if they were made from the same raw material by geochemical analysis and if we compare fabrics and several samples of clay from both sites. Types L1, L3 and L4 appear on Jalžabet-Bartolovac, Iovia and Petrijanec. L3 can also be

TIP POSUDE	1. st.	2. st.	3. st.	4. st.	5. st.
L 1	[Red line spanning all columns]				
L 2	[Red line spanning all columns]				
L 3		[Red line spanning columns 2-5]			
L 4		[Red line spanning columns 2-5]			
L 5			[Red line spanning columns 3-5]		
L 6			[Red line spanning columns 3-5]		
L 7	[Red line spanning all columns]				
L 8			[Red line spanning columns 3-5]		

Sl. 148 Tipološko-kronološka tabela lonaca L1–8  
Fig. 148 Typological and chronological table of pots L1–8

je jako naglašeno, ukrašeno češljastima ukrasom i imaju naglašen vrat. Lonci iz Jalžabet-Bartolovca, Jovije, Akva Jasa, Andautonije i Komina pored drukčije izrade razlikuju se od lonaca s Virovitice Kiškorije jug i Orešca po tome što ih je većina ukrašena različitim motivima češljastim ukrasom (Vikić-Belančić, Gorenc 1958: 110, T. XVII: 53; Vikić-Belančić 1974: 104–105, T. XVI). Posuda slična L5 tipu zabilježena je u 4. st. na lokalitetu Radovanci – Brdo. Lonci tipa L6–8 nisu uočeni na drugim lokalitetima te prema dosadašnjim objavama i uvidu u građu predstavljaju lokalnu specifičnost Virovitice Kiškorije jug i Orešca.

**3.3.2. Zdjele** (lat. *acetabulum*; *caccabus*, eng. *bowl*; njem. *Schüssel*; tal. *ciotola/tegame*; fra. *cuvette*)

*Acetabulum* je zdjela za držanje octa, meda, služila je za kuhanje i serviranje. Izrađivane su od zlata, srebra i keramike (Hilgers 1969: 33–34, 91–92). *Caccabus* je posuda za kuhanje i dolazi s poklopcem, izrađivan je od metala i keramike (Hilgers 1969: 40–41, 124–125). Tipološki gledano, postoji velik broj zdjela ovisno o namjeni i ukusu, prapovijesnoj tradiciji i utjecajima i vremenskom razdoblju. Kroz desetljeća i stoljeća njihov oblik se mijenjao, međutim kod keramike lokalne proizvodnje prevladavaju jednostavni oblici koji se vežu na prapovijesne tradicije. Prisutni su i oblici koji su imitacije skupocjenog posuđa, bilo izrađenog od keramike, metala ili stakla. Što se tiče prapovijesne tradicije, u ovom slučaju, keramičkih oblika koji su vezani na latenske zdjele, imamo zdjele s uvučenim obodom i zdjele blage S profilacije. Prevladavaju međutim jednostavni oblici ravnog oboda, blago zaobljenih ili kosih stijenki. Vrlo su slični tanjurima koji su jako zastupljeni u rimskim naseljima, ali i nekropolama te ove zdjele predstavljaju njihovu dublju varijantu. Zastupljen je i kasnoantički oblik vrlo raširenog tipa glaziranih zdjela s vodoravno izvijenim obodom koji nosi različite ukrase. Veći dio zdjela ima premaz, zbog kojeg se čini da su te zdjele služile za kuhanje ili serviranje tekuće hrane. Premaz imaju zdjele kat. br. 64, 102, 159, 200–201, 222, dok 91 i 165 imaju glazuru (zeleno maslinastu) što je također sprječavalo poroznost posude odnosno, omogućavalo je držanje tekućeg sadržaja. Zdjele su svrstane u četiri tipa prema njihovom obliku.

Prvi tip čine zdjele **Z1** (T. 5: 3; T. 9: 4; T. 22: 7–9; T. 28: 2) (kat br 41, 64; 200–202, 222, 225) koje imaju ravne ili blago zaobljene stjenke, ravan ili blago zaobljen obod (sl. 149). Posude su rađene rukom, a glina je nepročišćena sa sitnim primjesama.

Zdjela kat. br. 225 ima analogiju u Singidunumu na dva lokaliteta (Konak kneginje Ljubice i Donji grad), a datira se u 2. stoljeće (Bjelajac 1995: 34; Nikolić-Đorđević 2000: 35, 36, 208; 2002: 224, sl. 2: 23). Zdjela ovakvog oblika sive boje izrađena rukom pronađena je u grobu 55 u Novom Mestu na Beletovom vrtu (Knez 1992: 35, T. 17: 4).

found on the late Antique necropolis Radovanci Brdo. It has been discerned by examination of the material from Andautonia, that the pots from that site are significantly different. They are typologically very different, because their rims are more curved, the shoulder is very emphasised and it has a combed decoration, and they have an emphasised neck. Beside the diverse production, the pots from Jalžabet-Bartolovac, *Iovia*, *Aquae lasae*, *Andautonia* and Komin are different from pots from Virovitica Kiškorija south and Orešac, for most of them have diverse combed decorations (Vikić-Belančić, Gorenc 1958: 110, T. XVII: 53; Vikić-Belančić 1974: 104–105, T. XVI). A pot similar to L5 type was registered on Radovanci - Brdo site and dates to the 4<sup>th</sup> century. Type L6–8 pots have not been registered on any other sites. According to the publications so far and the insight into material they represent a local specificity.

**3.3.2. Bowls** (Lat. *acetabulum*; *caccabus*; Ger. *Schüssel*; Ital. *ciotola/tegame*; Fr. *cuvette*)

*Acetabulum* is a bowl for vinegar or honey which was also used for cooking and serving food. They were made of gold, silver or ceramics (Hilgers 1969: 33–34, 91–92). *Caccabus* is a cooking bowl which comes with a lid, and it was made of metal or ceramics (Hilgers 1969: 40–41, 124–125). Typologically, there is a large number of bowls depending on purpose or taste, prehistoric tradition and influences, and the time period. Their shape changed over decades and centuries, but the locally produced ceramics are simply shaped and associated with prehistoric traditions. There are some forms that imitate expensive dishes, and they can be made of ceramics, metal or glass. In case of the ceramic forms that are connected with La Tène bowls, regarding the prehistoric tradition, there are bowls with the rim drawn inward and bowls with a slight S-profilation. However, simple forms with straight rim, lightly rounded and with oblique walls prevail. They are very similar to plates which are frequent in the Roman settlements, as well as on necropolis. These bowls represent their deeper version. There is also a Late Antique form of a widespread type of glazed bowls which have a horizontally curved rim with different decorations. Most of the bowls have slip, due to which they were probably used for cooking or serving of liquid food. Bowls Cat. Nos. 64, 102, 159, 200–201, 222 have slip, while 91 and 165 are glazed (in olive green colour), which also prevented the porosity of a vessel and enable the storage of liquids. The bowls are, according to their form, divided into four types.

The first type are bowls **Z1** (Pl. 5: 3; Pl. 9: 4; Pl. 22: 7–9; Pl. 28: 2) (Cat. Nos. 41, 64; 200–202, 222, 225), which have straight or lightly rounded walls and straight or lightly rounded rim (fig. 149). These bowls are made by hand and the clay is unrefined with tiny inclusions.

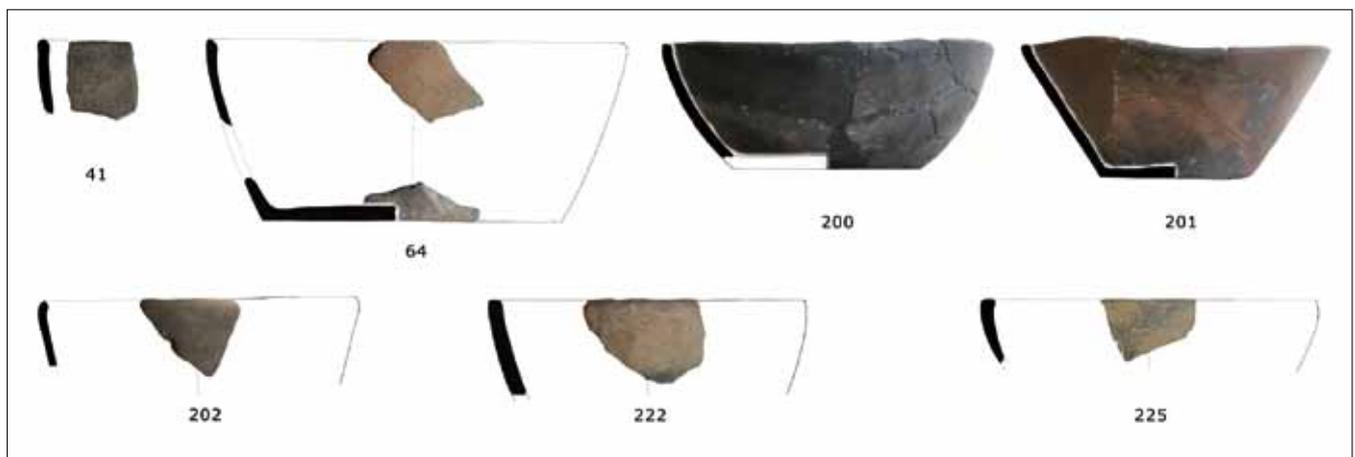

Sl. 149 Zdjelje tip 1  
Fig. 149 Type 1 bowls

Rukom rađena zdjelica analogna kat. br. 222 pronađena je u grobovima 61, 71, 117 u Novom Mestu na Beletovom vrtu (Knez 1992: 37, 40, 49, T. 21: 7; T. 27: 2; T. 117: 9), u Vranju kod Sevnice gdje se datira u kasnu antiku (Knific 1979: 735, 739, 742, 743, br. 58, 99). U Sisciji su pronađene ovakve zdjele, izrađene od iste strukture kao i mnogobrojni latenoidni lonci tipa L1 (Jelinčić 2009: T. 113: 1–2).

Slične zdjele analogne posudama iz ove grupe nalaze se i u drugim grobovima u Petoviju na Beletovom vrtu: 115, 117, 120, 160, 176, 199, 204 (Knez 1992: 49, 50, 58, 61, 65, 68, T. 41: 5–6; T. 4: 10; T. 44: 10; T. 56: 11, 13; T. 63: 4–6; T. 70: 11; T. 72: 9), također u Vranju kod Sevnice (Knific 1979: 739, 745, br. 104, 137).

Na lokalitetu Zalalövő pronađena je posuda sive boje, koja je definirana kao tanjur, a nalik je ovom tipu zdjele (Cserményi 1977: 246, 258, abb. 48: 1), zatim na kasnoantičkim lokalitetima Szentlászló-Szentegyedpuszta i Kő gdje su okarakterizirane kao keramika rimskog provincionalnog karaktera (Dombay 1957: 327, T. 35: 6–7). U kasnoantičkom kontekstu ovakve zdjele pronađene su u Mađarskoj na lokalitetu Szakály (Gabler, Ottományi 1990: 176, Fig. 11: 1–2, 176). Ovaj tip zdjele datira se od 2. stoljeća pa do kraja kasne antike (sl. 153).

Drugi tip **Z2** (T. 15: 10; T. 16: 4, 8) čine posude koje imaju zaobljene stjenke, a obod je uvučen prema unutra (kataloški brojevi 117, 125, 129) (sl. 150). Posude su iste fakture kako i posude Z1 tipa. Radi se zapravo o imitaciji vrlo popularnog oblika zdjele originalno izrađivanog u tehnici tere sigilate Drag. 32, koji je čest u Panoniji i datira se u drugu polovinu 2. i prvu polovinu 3. st. (Bukner 1981: 88; Ožanić 2004a: 27–28, 74). Ipak, posude sličnog oblika spominju se i kao tradicija latenskog lončarstva u 1. st. po. Kr., čak i kao nasljeđe iz Hallstatta (Bukner 1981: 92; Vidošević 2003: 18; Ottományi 2005: 113, Abb. 14: 5). Analogije za zdjele ovakvog oboda pronađene su na više lokaliteta: Keszthely-Újmajor, Trebnje, Hrtkovci, Stenjevec, Drumoly (Bónis 1942: 174–175, T. XXII: 5), Žirovac–Ruma -

The bowl Cat. No. 226 has an analogy on two sites in *Singidunum* (Konak kneginje Ljubice and Donji grad) and dates to the 2<sup>nd</sup> century (Bjelajac 1995: 34; Nikolić-Đorđević 2000: 35, 36, 208; 2002: 224, sl. 2: 23). A handmade grey bowl of this shape was found in the grave 55 in Beletov vrt, Novo Mesto (Knez 1992: 35, T. 17: 4).

A small handmade bowl analogue to Cat. No. 222 was found in graves 61, 71, 117 in Beletov vrt, Novo Mesto (Knez 1992: 37, 40, 49, T. 21: 7; T. 27: 2; T. 117: 9) and in Vranj near Sevnica, where it dates to Late Antiquity (Knific 1979: 735, 739, 742, 743, br. 58, 99). This kind of bowl was found in *Siscia*, where they have the same structure like numerous latenoid pots of the L1 type (Jelinčić 2009: T. 113: 1–2).

Similar bowls, analogue to the vessels of this group, can be found in other graves in Beletov vrt, in *Poetovium*: 115, 117, 120, 160, 176, 199, 204 (Knez 1992: 49, 50, 58, 61, 65, 68, T. 41: 5–6; T. 4: 10; T. 44: 10; T. 56: 11, 13; T. 63: 4–6; T. 70: 11; T. 72: 9), as well as in Vranj near Sevnica (Knific 1979: 739, 745, br. 104,

A grey vessel resembling this type of bowl, which is defined as a plate, was found on Zalalövő site, (Cserményi 1977: 246, 258, abb. 48: 1) and subsequently on late Antiquity sites of Szentlászló-Szentegyedpuszta and Kő, where they are characterised as Roman provincial ceramics (Dombay 1957: 327, T. 35: 6–7). In the Late Antiquity context, bowls of this type were found on Szakály site in Hungary (Gabler, Ottományi 1990: 176, Fig. 11: 1–2, 176). This type of bowls dates from the 2<sup>nd</sup> century to the end of the Late Antiquity (fig.153).

The second type, **Z2** (Pl. 15: 10; Pl. 16: 4, 8), are bowls with curved walls and an inwardly drawn rim (catalogue numbers 117, 125, 129) (fig.150). The vessels are of the same fabric as the Z1 type of vessels. It is in fact an imitation of a very popular bowl shape, originally produced in terra sigillata Drag. 32 technique, which is common in Pannonia and dates to the second half of the 2<sup>nd</sup> and the first half of the 3<sup>rd</sup> century (Bukner 1981: 88; Ožanić 2004a: 27–28, 74). Ne-



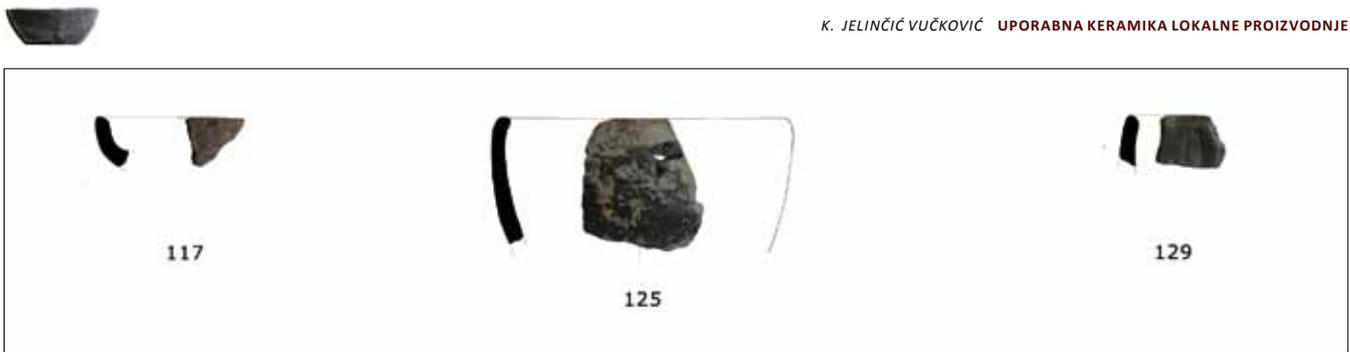

Sl. 150 Zdjele tip 2  
Fig. 150 Type 2 bowls

domorodačko naselje iz 1. st. (Brukner 1995a: 100, 128, T. XVIII: 181), Livade – nekropola (Milošević 1995: 204, 216, T. XI: Grob 51, 3), Sviloš (pronađena u kulturnom sloju), (Dautova-Ruševljan 2003: 32, T. LI: 3). Zdjele s uvučenim obodom srećemo i u Sirmiju i na Gomolavi i Dumbovu, a Brukner ih datira u 1. st. po. Kr. (Brukner 1971: 92, T. 78), pronađene su i na Tekiji gdje se datiraju također u 1. st. (Cermanović-Kuzmanović 2004: 116), Nauportu (Petru, Petru 1978: 73, T. XXXIV: 6), analogna zdjelica pronađena je u grobu 139 u Novom Mestu na lokalitetu Beletov vrt (Knez 1992: 54, T. 50: 5), te grobu iz 332 (Kujundžić 1982: 50, T. 25: 18), na lokalitetu Sv. Križ u Sisku (Bugar 2000: 19, T. VII: 1–3), u Fenékpusztu u grobu ovakav tip datiran je u kasnu antiku (Sagí 1960: 188, Abb. 2: 6), dok je u Intercisi datiran u 3.–4. st. (Poczy 1957: 133, T. XVI: 12). Na području Gornje Panonije ovakve zdjele, analogne oblikom, mogu se još naći na groblju u Stenjevcu (Gregl 1989: 19, T. 6: 6). Ovaj tip posude javlja se i u kasnolatsko-rimskom naselju Budaörs (Ottományi 2005: 113, Abb. 14: 5), na lokalitetu Zalalövő gdje je pronađeno više posuda ovakve profilacije, a autor ih svrstava u tanjure (Bilkei, Solti 1976: 176, 178, 181, Abb. 28: 3, Abb. 29: 5, Abb. 32: 1, Abb. 38: 15–15; Cserményi 1977: 246, 258, abb. 48: 2–3). Veliki broj ovakvih zdjela različite strukture pronađen je u Topuskom (Jelinčić 2009: T. 106; T. 107: 1–2). Na rimskom paljevinskom groblju u Petoviju pronađeni su tanjuri koji imaju obod oblikovan poput ovog tipa zdjela, međutim oni su crveno pečene boje sa žarkim crvenim premazom: grob 3, 9 (Tušek 1993: 396, T. 2: 13, 15; T. 19: 8).

Pregledom materijala uočava se dugotrajno korištenje ovog oblika zdjele, od 1. stoljeća pa do kraja kasne antike (sl. 153).

Treći tip **Z3** (T. 11: 7; T. 19: 4) (91, 165) čine zdjele s obodom koji je vodoravno izvučen prema van, unutrašnjost zdjele je glazirana (kataloški brojevi 91, 165), a boja glazure je zelenomaslinasta (sl. 151). Obodi su s gornje strane ukrašeni, a glina je pročišćena. Zdjela kat. br. 91 je iz objekta datiranog <sup>14</sup>C datumom od 239. do 361. g., a zdjela kat. br. 165 je iz objekta datiranog od 412. do 534. g. Pripadaju vrlo raširenom tipu kasnoantičkih posuda s ukrašenim vodoravnim obodima i glaziranom unutrašnjosti. Takav obod i ukrasi prisutni su i kod tanjura u kasnoj antici. Zdjele i tan-

vertheless, the pots of similar shape are mentioned as a La Tène pottery tradition in the 1<sup>st</sup> century and even as a Hallstatt succession (Brukner 1981: 92; Vidošević 2003: 18; Ottományi 2005: 113, Abb. 14: 5). Analogies for pots with this kind of rim were found on several sites: Keszthely-Újmajor, Trebnje, Hrtkovci, Stenjevec, Drumoly (Bónis 1942: 174–175, T. XXII: 5), Žirovac–Ruma – an indigenous settlement from the 1<sup>st</sup> century (Brukner 1995a: 100, 128, T. XVIII: 181), Livade–necropolis (Milošević 1995: 204, 216, T. XI: Grob 51, 3), Sviloš (found in a cultural layer), (Dautova-Ruševljan 2003: 32, T. LI: 3). We can also encounter bowls with an inward drawn rim in Sirmium, Gomoglava and Dumbovo, and Brukner dates them to the 1<sup>st</sup> century (Brukner 1971: 92, T. 78). They were also found on Tekija where they date to the 1<sup>st</sup> century as well (Cermanović-Kuzmanović 2004: 116), and Nauportus (Petru, Petru 1978: 73, T. XXXIV: 6). An analogue small bowl was found in the grave 139 in Beletov vrt, Novo Mesto (Knez 1992: 54, T. 50: 5), in grave from 332 (Kujundžić 1982: 50, T. 25: 18), on Sv. Križ site in Sisak (Bugar 2000: 19, T. VII: 1–3) and in a grave in Fenékpuszt where it was dated to the late Antiquity (Sagí 1960: 188, Abb. 2: 6), while in Intercisa it was dated to the 3<sup>rd</sup>–4<sup>th</sup> century (Poczy 1957: 133, T. XVI: 12). In the area of Upper Pannonia, bowls analogue of these can be found on the cemetery in Stenjevec (Gregl 1989: 19, T. 6: 6). This type of vessel also appears in Budaörs, the late La Tène-Roman settlement (Ottományi 2005: 113, Abb. 14: 5) and on Zalalövő site, where more vessels of this profile were found and the author classifies them as plates (Bilkei, Solti 1976: 176, 178, 181, Abb. 28: 3, Abb. 29: 5, Abb. 32: 1, Abb. 38: 15–15; Cserményi 1977: 246, 258, abb. 48: 2–3). Many pots like this with different fabric were found in Topusko (Jelinčić 2009: T. 106; T. 107: 1–2). Plates with a rim shaped same as on bowls of this type were found on the Roman incineration cemetery in *Poetovium*, yet they have a red firing colour with a bright red slip: grave 3, 9 (Tušek 1993: 396, T. 2: 13, 15; T. 19: 8).

An extended use of this shape of bowl can be noted, by the examination of material, from the 1<sup>st</sup> century to the end of the Late Antiquity (fig.153).

The third type, **Z3** (Pl. 11: 7; Pl. 19: 4) (91, 165), are bowls with a horizontally outward drawn rim and an olive green glaze (fig.151) on the inside of the bowl (catalogue num-



Sl. 151 Zdjela tip 3  
Fig. 151 Type 3 bowls

juri ovog tipa okvirno se datiraju od početka 3. st. do u 5. st. Glazirane zdjele i tanjuri vodoravnog oboda vrlo su česti u kasnoj antici, a na njihovim obodima nalaze se ukrasi različitih motiva, koncentrične kružnice, ukrasi kotačićem ili ukrasi izvedeni prstima (Cvjetičanin 2006: 34–39). Ove su posude izrađivane po uzoru na srebrene i brončane posude (Bónis 1991: 91, Abb. 1: 129).

Veliki broj glaziranih zdjela s obodom ukrašenim koncentričnim kružnicama kao što je ovdje slučaj s kat. br. 165, iz objekta datiranog od 412.–534. g. pronađen je u Sirmiju prilikom istraživanja rustične kasnoantičke vile (Parović-Pešikan 1971: 35, XXI, 72, 3). Zdjelica s obodom koji je nalik obodu kat. br. 165 pronađena je u Iloku, s time da iločka zdjelica ima nešto razrađeniji obod (Jelinčić 2003: 81, T. 1: 7). Analogije postoje i u Mađarskoj, na lokalitetu Píliszántó (između Brigecija i Akvinkuma), (Maróti 1985: T. X), na lokalitetu TÁC – Fövenypusztá (Thomas 1955: 106, Abb. 3: 41–42; Thomas 1964: 321, T. CCVI). Veliki broj ovakvih posuda zastupljen je na mađarskom lokalitetu Tokod (Bónis 1991: 103–104, Abb. 9: 3), zatim Cibalama (Ožanić 2004a: 80, T. 20: 31–32) i Osječnici (Ožanić 1998: T. 14: 8). Veći broj analogija prisutan je u Donjoj Panoniji nego u Gornjoj Panoniji. Nejasno je međutim, radi li se o stanju istraženosti i stupnju objavljenosti materijala ili je to ipak pokazatelj veće zastupljenosti ovog tipa u Donjoj Panoniji.

Struktura kat. br. 91 upućuje lokalnu proizvodnju ovog tipa zdjele. Ostaje otvoreno pitanje gdje se točno proizvodio, budući da je proizvodnja glaziranog posuđa složena. Ovaj tip zdjela javlja se od 3. do u 5. stoljeće (sl. 153).

Četvrti tip **Z4** (T. 14: 4; T. 15: 4; T. 18: 16) čine zdjele S profilacije. Kod nekih zdjela obod je više izvijen prema van, tijelo može biti šire od oboda, a može biti i uže (katalogski broj 102, 112, 161) (sl. 152).

S profilacija zdjela vrlo je karakteristična za latensko razdoblje, međutim kod latenskih zdjela profilacija je mnogo naglašenija nego u slučaju zdjela koje se ovdje obrađuju. Zdjela S profilacije od nepročišćene gline koja ima i ukras pronađena je u grobu 45 u Ptuju (Kujundžić 1982: 18, T. 5: 12), slična je posuda pronađena u grobu 35 u Nagykanizsi i datira se od 3.–4. st. (Eke, Horváth 2006: 78, sl. 6: 5), zatim na lokalitetu Szakály gdje je datirana u kasnu antiku (Gabler, Ottományi 1990: 177, 181, Fig. 13: 1). Posude

bers 91, 165). Rims are decorated on the upper side and the clay is refined. The bowl Cat. No. 91 is made of fabric dated with  $^{14}\text{C}$  method from the year 239 to the year 361 and the bowl Cat. No. 165 is from a structure dated from the year 412 to the year 534. They belong to a widespread type of Late Antiquity vessels, which have decorated horizontal rims and glaze on the inside. This kind of rim and decorations are also present on plates from Late Antiquity. Bowls and plates of this type are approximately dated from the early 3<sup>rd</sup> to the 5<sup>th</sup> century. Glazed bowls and plates with a horizontal rim are frequent in Late Antiquity and they have different decorations (concentric circles, rouletting decorations or decorations made by hand) (Cvjetičanin 2006: 34–39). These vessels were modelled after silver and bronze vessels (Bónis 1991: 91, Abb. 1: 129).

A large number of glazed bowls with a rim decorated with concentric circles, like Cat. No. 165 from the structure that dates from year 412–534, were found in *Sirmium* during the research of the Late Antique villa rustica (Parović-Pešikan 1971: 35, XXI, 72, 3). A small bowl with a rim that looks like the rim of Cat. No. 165 was found in Ilok, but the bowl from Ilok has a more elaborate rim (Jelinčić 2003: 81, T. 1: 7). There are also some analogies in Hungary, on Píliszántó site (between *Brigetium* and *Aquincum*), (Maróti 1985: T. X) and on TÁC – Fövenypusztá site (Thomas 1955: 106, Abb. 3: 41–42; Thomas 1964: 321, T. CCVI). Many vessels like these are present on the Hungarian site of Tokod (Bónis 1991: 103–104, Abb. 9: 3), Cibala (Ožanić 2004a: 80, T. 20: 31–32) and Osječnica (Ožanić 1998: T. 14: 8). More analogies are present in the Lower Pannonia than in the Upper Pannonia. However, it is unclear whether that is the result of the research stage and level of published materials or it is in fact the result of a greater representation of this type in Lower Pannonia. The fabric of Cat. No. 91 indicates that this type of bowl was locally produced. It remains an open question, where exactly was the pottery produced, since the production of glazed pottery is complex. This type of bowl appears from the 3<sup>rd</sup> to the 5<sup>th</sup> century (fig. 153).

The fourth type, **Z4** (Pl. 14: 4; Pl. 15: 4; Pl. 18: 16), consists of S-profiled bowls. Some of the bowls have a more outwardly drawn rim and their body can be wider or narrower than the rim (catalogue numbers 102, 112, 161) (fig.

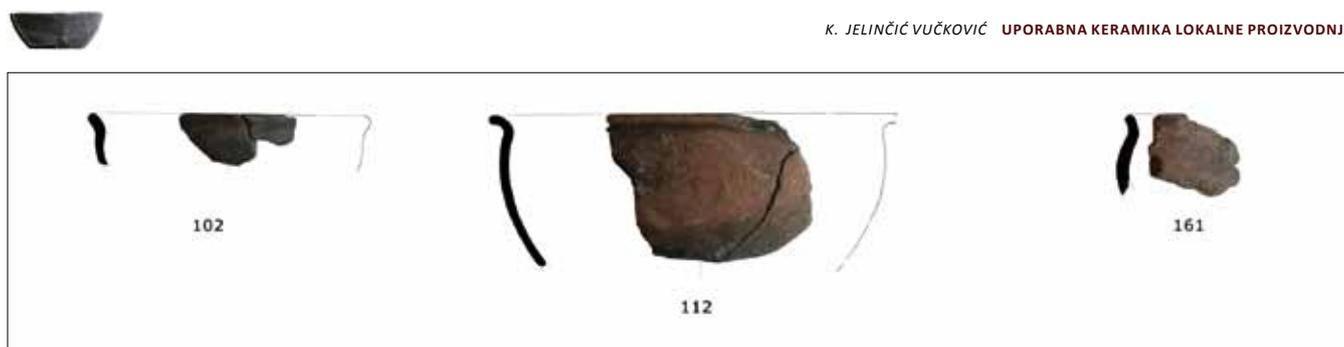

Sl. 152 Zdjela tip 4  
Fig. 152 Type 4 bowls

četvrtog tipa nemaju jako izraženu S profilaciju što bi moglo značiti da su te posude mlađe od onih koje se direktno vežu na latenske posude, a datiraju se u 1. st. po. Kr.

U Andautoniji postoji veliki broj zdjela S profilacije, međutim ona je jako naglašena (Jelinčić 2009: T. 103; T. 104: 2–3; T. 105), zatim u Joviji (Jelinčić 2009: T. 59: 1), Gornjim Čehima (Jelinčić 2009: T. 72: 2) i Sisciji (Jelinčić 2009: T. 113: 2).

Najbrojnije su zdjele ravnog oboda blago zaobljenih ili kosih stijenki te zdjele S profilacije, a za njih ima malo analogija. S obzirom na činjenicu da je ponekad teško odrediti granicu između tanjura, zdjela i pladnjeva zbog fragmentarnosti nalaza, također nije uvijek jednostavno ulomke posuda opredijeliti u neki od tih tipova. Ovo je važan problem za prvi tip zdjela koji je ovdje izdvojen budući da su obod i nagib tijela tih zdjela nalik tanjurima koji su zastupljeni u velikom broju u Panoniji, dok su zdjele rijetke (prema do sada objavljenom materijalu).

### 3.3.3. Tanjuri (lat. *patina, phiala*, njem. *Teller*, eng. *plate*, tal. *piatto*, fra. *plat*)

U izvorima se bilježi više naziva za posude koje mi danas zovemo tanjurima, a na latinskom oni, ovisno o funkciji, imaju različite nazive. Riječ je o posudi širokog oboda koja

152).

The S profile of the bowls is a characteristic of the La Tène period, although the La Tène bowls have a more emphasised profile than these bowls. A S-profiled bowl made from unrefined clay and with a decoration was found in the grave 45 in Ptuj (Kujundžić 1982: 18, T. 5: 12). Similar bowl was found in the grave 35 in Nagykanizsa and dates to the 3<sup>rd</sup>–the 4<sup>th</sup> century (Eke, Horváth 2006: 78, sl. 6: 5) and another one was found on Szakály site which dates to the Late Antiquity (Gabler, Ottományi 1990: 177, 181, Fig. 13: 1). Vessels of the fourth type do not have a very expressed S profile, which could mean that they are more recent than the ones directly associated with the La Tène ones. They date to the 1<sup>st</sup> century.

There are many S-profile bowls in *Andautonia*, but with a strongly emphasised profile (Jelinčić 2009: T. 103; T. 104: 2–3; T. 105), in *Iovia* (Jelinčić 2009: T. 59: 1), Gornji Čehi (Jelinčić 2009: T. 72: 2) and *Siscia* (Jelinčić 2009: T. 113: 2).

The most numerous are the bowls with a straight rim and a lightly curved or oblique walls, and the S-profiled bowls, which do not have many analogies. Due to the fact that sometimes it is difficult to determine the line between plates, bowls and trays, as a result of the finds' fragmentary condition, it is not always simple to classify fragments of the vessels into types. This is a significant problem for the first type of bowls mentioned above, since their rim and

TIP POSUDE	1. st.	2. st.	3. st.	4. st.	5. st.

Sl. 153 Tipološko-kronološka tabela zdjela  
Fig. 153 Typological and chronological table of bowls



je mogla imati poklopac i mogla je služiti u kultne svrhe. Izrađivana je od metala, stakla i keramike (*patina*), (Hilgers 1969: 72–73, 245–247). *Phiala* svojim opisom i kontekstom odgovara tanjuru, međutim izrađivana je od metala i stakla (Hilgers 1969: 74, 250–252). Tanjuri koji čine ovu tipologiju s obzirom na kontekst ruralne sredine vjerojatno su imali ulogu posude koja je služila kod kuhanja i serviranja hrane.

Tanjuri su, kao i zdjele, vrlo čest nalaz u grobovima, posebno u 2. st. po. Kr. u paljevinskim grobovima (Plesničar-Gec 1977: 84). U jugozapadnom dijelu Panonije, tanjuri se više oslanjaju na italske keramičke oblike nego na oblike latenske tradicije. Postoji mnogo varijanata, a razlikuju se po nagibu i obliku stijenke, profilaciji oboda, obliku dna, mogu biti ukrašeni i neukrašeni (Bonis 1942: 48; Vikić Belančić 1965: 106; Gregl 1997: 62). Zbog talijanskih utjecaja pretpostavlja se da su tanjuri s uvučenim rubom raniji (Drenje 1987: 30). Ipak, tanjuri sa zadebljanim obodima, kao i zdjele, javljaju se i u 3. st. u grobovima datiranim novcem (Plesničar-Gec 1972: 43, 44, 46, T. LII: 18; T. LIII: 8; T. LVIII: 2–3). Kako se radi o vrlo čestom provincijalnom obliku i njihovoj tipološkoj raznolikosti i mnogobrojnosti, podrazumijeva se velika provincijska proizvodnja tih oblika. Pretpostavljena raširena proizvodnja u više radionica, od strane različitih majstora, podrazumijeva i mnogobrojnost oblika i varijanti oblika. Pregledom tanjura s lokaliteta Gornje Panonije uočena je njihova strukturalna raznolikost što ide u prilog lokalnoj proizvodnji, unatoč tome što su analogni kao tip (Jelinčić 2009: T. 76: 2–4; T. 87: 2; T. 107: 3–4; T. 121: 3–4).

Tanjuri s Virovitice Kiškorije jug podijeljeni su u dva tipa, a ravno dno zajedničko im je obilježje. Prvi tip ima zaobljen obod, kose ili blago zaobljene stijenke, a drugi ima kose ili blago zaobljene stijenke te obod koji je zadebljan na unutrašnjoj strani. To je ujedno opis većine tanjura koji se javljaju u cijeloj provinciji Gornjoj Panoniji, međutim, kako je već rečeno, tanjuri s drugih lokaliteta od ovih razlikuju se nagibom stijenke, oblikovanjem oboda, oblikom zadebljanja na unutrašnjoj strani oboda i dna. Ta tipološka raznolikost kod ovog jednostavnog i naoko jasno definiranog oblika govori u prilog razgranatoj mreži majstora i malih radionica koji su imali uski djelokrug izrade keramike i koje su djelovale u mikroregijama. Zbog toga se u literaturi ovaj oblik tanjura svrstava pod zajedničku kategoriju koja dozvoljava velik broj podvarijanti. Tako je npr. u Singidunumu pod jedan tip svrstan ovaj tip tanjura koji se datira od 1. do kraja 3. stoljeća s velikim brojem varijanti od kojih su neke isključivo lokalne, specifične za Singidunum (Nikolić-Đorđević 2000: 98–99, 112). O takvoj situaciji svjedoči i groblje na Matrici (Topál 1981: 88). Bónis navodi kako je na tanjurima prisutan crveni premaz, a u kasnijim stoljećima i sivi (Bónis 1942: 49).

Prvi tip tanjura **T1** (T. 1: 7; T. 8: 7; T. 11: 2; T. 22: 6; T. 26: 12), (kat br 7, 54, 86, 199, 219) ima blago zaobljen obod, kose ili vrlo blago konveksne stijenke (sl. 154). Takvog su oblika

curvature of their body look like the plates that are widely present in Pannonia, while the bowls are rare (according to the material published so far).

### 3.3.3. Plates (Lat. *patina*, *phiala*; Ger. *Teller*, Ital. *piatto*, Fr. *plat*)

In sources, there are several terms for vessels we nowadays call plates. Terms used to refer to plates in Latin depend on their function. It is a wide rim vessel which may have had a lid and may have served for cult purposes. It was made from metal, glass or ceramics (*patina*), (Hilgers 1969: 72–73, 245–247). *Phiala* corresponds to plate by its description and context, but it was made from metal or glass (Hilgers 1969: 74, 250–252). Considering the context of the rural environment, the plates that constitute this typology probably had the role of a vessel that served for cooking and serving of food.

Same as bowls, plates are frequently found in graves, especially in incineration cemeteries which date to the 2<sup>nd</sup> century (Plesničar-Gec 1977: 84). In the south-western part of Pannonia, plates rely much more on the Italic ceramic shapes than on the La Tène traditions. There are many versions, they are different in wall curvature and shape, rim profilation, shape of the base, and they can be with or without decoration (Bonis 1942: 48; Vikić Belančić 1965: 106; Gregl 1997: 62). It is assumed, because of the Italian influence, that the plates with an inward drawn edge are older (Drenje 1987: 30). Nevertheless, the plates with thickened rims, as well as bowls, can also be found in graves which, based on the coin finds, date to the 3<sup>rd</sup> century (Plesničar-Gec 1972: 43, 44, 46, T. LII: 18; T. LIII: 8; T. LVIII: 2–3). Given the reason that it is a very common provincial shape and its typological diversity and multitude, it implies a large provincial production of those shapes. The assumed widespread production in multiple workshops, by various craftsmen also implies multiple and various shapes. The examination of plates from Upper Pannonia sites has revealed their structural diversity, which favours the local production, despite them being analogue as a type (Jelinčić 2009: T. 76: 2–4; T. 87: 2; T. 107: 3/4; T. 121: 3/4).

Plates from Virovitica Kiškorija south are divided into two types, a flat base is their common feature. The first type has a curved rim and oblique or lightly curved walls, while the second type has oblique or lightly curved walls and a rim thickened on the inner side. This is likewise the description of most plates from the whole province of Upper Pannonia; still, as earlier said, plates from the other sites are different from these in the curvature of the wall, rim shape and the shape of the thickening on the inside of the rim and the base. This typological diversity of this simple and seemingly clearly defined shape suggests that there was a widespread network of craftsmen and workshops,

"pompejanski tanjuri" koji se datiraju id 1. st. pr. Kr. do 1. st. po. Kr. te imaju bitno drukčiju strukturu. Proizvode se u Italiji od republikanskog vremena, a rimskim osvajanjem javljaju se i u provincijama. Proizvodnja tanjura koji samo svojim oblikom podsjećaju na pompejanske počinje u provincijama i traje do u 4. st. (Koščević, Makjanić 1986–1987: 32; Brukner 1981: 39; Vidošević 2003: 17). Njihovo obilježje je jednostavnost i skromnost oblika, ravno dno, malo zakošene stijenke i lagano zadebljanje na obodu (Koščević, Makjanić 1986–1987: 32; Gregl 1997: 62–63). Navedeni su primjeri imitacije tog tipa posuda manjih dimenzija, a datiraju se od 1.–3. st. (Brukner 1981: 39, 85–86). Prvi tip čine kataloške jedinice 7, 86, 54, 199, 219. Osim kat. br. 199 svi primjerci imaju crni premaz na unutrašnjoj stijenki, a kat. br. 7 i na vanjskoj. Zbog tog premaza, koji je sprječavao poroznost posude, pretpostavlja se da je služila za kuhanje ili služenje tekuće hrane. Na svim ostalim tanjurima premaz je vrlo loše sačuvan i jedva vidljiv. Tanjuri kat. br. 7, 54 i 86 pronađeni su u zatvorenim cjelinama i datiraju se od 3. do 4. st. Kat. br. 86 je iz zatvorene cjeline datirane <sup>14</sup>C metodom od 239. do 361. g. Prva dva imaju crni premaz i rađeni su rukom dok je treći izrađen na kolu i ima sivi premaz.

Posuda iz groba datirana u 4. st. s lokaliteta Radovanci – Brdo, ima isti oblik i strukturu koja je srodna VKJ 2 strukturi te ima premaz na unutrašnjoj strani (Sokač-Štimac 1976: 89–90, T. XXXVIII). U Gornjoj Panoniji analogije su pronađene na Drenju u sloju i jami (Drenje 1987: 30, 34–35, 39, 42, T. 9: 1–4; T. 19: 4), u Sisku (Bugar 2000: 25, T. XI: 1; Katavić 2001: 28, T. VI: 8–9; Kordić 2001: T. 13: 2–3; Wiewegh 2001: 95, T. IX: 3, 8; Vidošević 2003: 17, T. 7: 1), Osječnici (Ožanić 1998: 31, T. 4: 3, 5), Ptuju – grob 42, zapadno groblje (Istenič 2000: 29, T. 9: 8), na istočnom groblju u Ptuju (Kujundžić 1982: 16, 27, 37, T. 3: 6; T. 12: 22; T. 18: 14). U Novom mestu na groblju na Beletovom vrtu pronađene su zdjele koje imaju istu profilaciju kao i ovi tanjuri (Knez 1992: T. 63: 4, 6). Analogni tanjur pronađen je u Neviodunumu (Petru, Petru 1978: 74, T. XXXVI: 29). U Topuskom je pronađena posuda koja je kataloški obrađena kao plitka zdjela, a podsjeća na ovaj tip tanjura. Pronađena je u grobu koji se datira u kraj 2. i početak 3. stoljeća (Šarić 1979–1980: 139, 141, T. VII: 7). U ženskom grobu 2 na lokalitetu Baláca pronađena je posuda koju je autorica opisala kao zdjelu, a koja je nalik prvom

that operated in a narrow field of ceramics production in micro regions. Therefore, this type of plates is classified in the literature under one category with many sub-variants. For example, in *Singidunum*, this type of plates dating from the 1<sup>st</sup> to the late 3<sup>rd</sup> century is categorised as one type with many variations. Some of those variations are exclusively local, particular for Singidunum (Nikolić-Đorđević 2000: 98–99, 112). Cemetery on Matrica testifies that situation (Topál 1981: 88). Bónis states that the plates have a red and in later centuries a grey slip (Bónis 1942: 49).

The first type of plates, **T1** (Pl. 1: 7; Pl. 8: 7; Pl. 11: 2; Pl. 22: 6; Pl. 26: 12), (Cat. Nos. 7, 54, 86, 199, 219), has a lightly rounded rim and oblique or lightly convex walls (fig. 154). Pompeian plates that date from the 1<sup>st</sup> century BC to the 1<sup>st</sup> century have that kind of shape, but they have a significantly different fabric. They are produced in Italy from the period of Roman Republic and later in provinces, during the Roman conquest. The production of plates, which only by shape resemble the Pompeian ones, begins in provinces and lasts during the 4<sup>th</sup> century (Koščević, Makjanić 1986–1987: 32; Brukner 1981: 39; Vidošević 2003: 17). Their features are: the simplicity and modesty of shape, a flat base, lightly oblique walls and a slight thickening of the rim (Koščević, Makjanić 1986–1987: 32; Gregl 1997: 62–63). The mentioned plates are an example of imitation of that type of vessels of smaller dimension and they date from the 1<sup>st</sup> to the 3<sup>rd</sup> century (Brukner 1981: 39, 85–86). The first type consists of catalogue units 7, 86, 54, 199, 219. All examples, except Cat. No. 199, have a black slip on the interior wall while Cat. No. 7 also has one on the exterior wall. This slip prevented the porosity of the vessel; therefore it is assumed that it was used for cooking or serving of liquid foods. On all other plates, the slip is poorly preserved and barely visible. Cat. No. 7, 54, and 86 plates were found in enclosed units and date from the 3<sup>rd</sup> to the 4<sup>th</sup> century. Cat. No. 86 is from an enclosed unit that dates from year 239 to 361, based on <sup>14</sup>C method. The first two have a black slip and they are made by hand, while the third one is made on a wheel and has a grey slip.

The vessel from the grave on Radovanci – Brdo site dates to the 4<sup>th</sup> century, it has shape and fracture similar to VKJ 2 fabric and slip on the inner wall (Sokač-Štimac 1976:

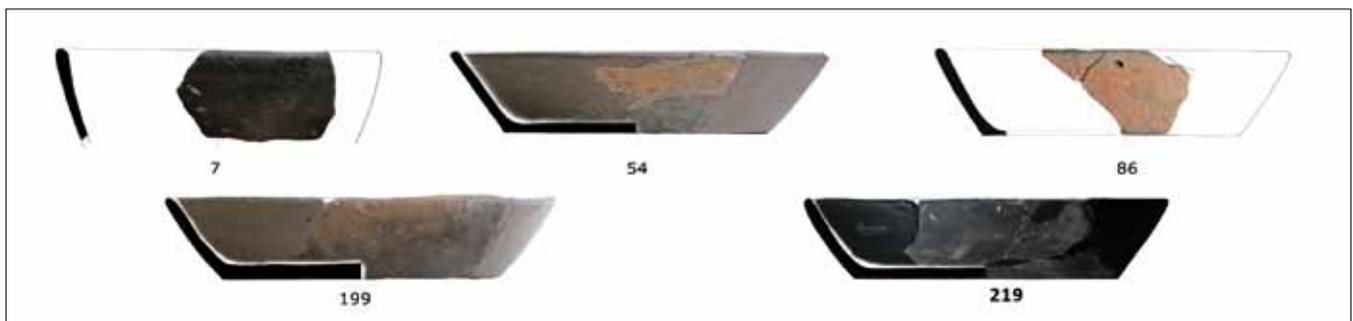

Sl. 154 Tanjuri tip 1  
Fig. 154 Type 1 plates

tipu tanjura (Csirke 2004: 245–246, 250–253, Abb. 4; 5: 1, 4; 6: 3; 7: 3). U Donjoj Panoniji ovakvi tanjuri pronađeni su u Mursi i Cibalama međutim s malo zaobljenijim stijenkama (Vikić-Belančić 1970: 167, T. VIII: 7; Brukner 1981: 85, T. 65: 10–11; Ožanić 2004a: 84, T. 16: 12, T. 71: 3/4), pronađeni su i u Mačvanskoj Mitrovici u grobu (Ercegović-Pavlović 1980: 9, Pl. X: 8), Babarcu (Fazekas 2007: 119, T. 20: 160), Sirmiju (Parović-Pešikan 1973: 24, T. XVIII: 1) i Matrici (Topál 1981: 34, 54, XXVII – grob 80, 1, L – grob 161, 3/4, 62, LVIII – grob 195, 2). Tanjuri prvog tipa pronađeni su u velikom broju u Ljubljani, gdje su datirani na prijelaz stare u novu eru (Vičić 2002: 195, 198, T. 5: 10). Pompejanski tanjuri, odnosno njihove imitacije, traju duže i moguće ih je datirati samo kontekstom. Na sjevernom groblju Emone, pronađene su zdjele koje dimenzijama i profilom odgovaraju tanjurima ovog kataloga i ovog tipa. Pronađeni su u paljevinskom grobu (Plesničar-Gec 1972: 20, T. XI. Grob 42, 7, 12). Neki su opisani kao tanjuri i također odgovaraju ovom tipu, a pronađeni su u paljevinskom grobu (Plesničar-Gec 1972: 27, T. XX, Grob 85, 13). Na mađarskom lokalitetu Zalalövő također je zastupljen ovaj tip tanjura (Cserményi 1977: 246, 264, abb. 60, 10). U Gornjoj Meziji analogije postoje u Tekiji (Cermanović-Kuzmanović 2004: 147–149, kat. 8). Tanjuri prvog tipa prisutni su i u Dakiji (Gudea 1996: 214–216, T. XXIII: 1, 4, T. XXIV: 1).

Pregledom analognog materijala te rezultata <sup>14</sup>C analiza objekata s Virovitice Kiškorije jug gdje je zastupljen ovaj tip tanjura, jasno je kako se on kontinuirano javlja od 1. do kraja 4. stoljeća (sl. 156).

Drugi tip tanjura T2 (T. 4: 5; T. 11: 3; T. 21: 4) (29, 87, 184 (?)) ima ista takva obilježja, a od prvog se razlikuje po obodu koji je zadebljan i naglašen na unutrašnjoj strani posude (sl. 155). Promjer oboda je od 13/40 cm, a provincijska proizvodnja se datira od 1.–4. st. (Brukner 1981: 86). Ovu grupu čine kataloški brojevi 29, 87 i 184 (?). Svi imaju premaz na unutrašnjoj strani tanjura i mogli su služiti za kuhanje i serviranje tekuće hrane kao i tanjuri prethodne grupe. Tanjur kat. br. 87 pronađen je u zatvorenoj cjelini i datiran je od 239. do 361. g. <sup>14</sup>C datumom. Tanjuri T2 izrađeni od strukture VKJ 2 (kat. br. 87, 29) imaju manje naglašeni obod od onih tanjura koji su izrađeni od strukture VKJ 23 (kat. br. 174). Kako je od strukture VKJ 2 načinjena većina keramičkih posuda s Virovitice Kiškorije jug, a za koje se pretpostavlja proizvodnja na samom lokalitetu

89–90, T. XXXVIII). In Upper Pannonia, the analogies were found on Drenje in the layer and in the pit (Drenje 1987: 30, 34–35, 39, 42, T. 9: 1–4; T. 19: 4), in Sisak (Bugar 2000: 25, T. XI: 1; Katavić 2001: 28, T. VI: 8–9; Kordić 2001: T. 13: 2–3; Wiewegh 2001: 95, T. IX: 3, 8; Vidošević 2003: 17, T. 7: 1), Osječnica (Ožanić 1998: 31, T. 4: 3, 5), Ptuj – grave 42, western cemetery (Istenić 2000: 29, T. 9: 8), as well as on the eastern cemetery in Ptuj (Kujundžić 1982: 16, 27, 37, T. 3: 6; T. 12: 22; T. 18: 14). Bowls with the same profile as these plates were found on the cemetery on Beletov vrt in Novo mesto (Knez 1992: T. 63: 4, 6). An analogue plate was found in *Neviodunum* (Petru, Petru 1978: 74, T. XXXVI: 29). In Topusko, a vessel was found, which was classified as a shallow bowl, but it resembles this type of plates. It was found in a grave that dates to the late 2<sup>nd</sup> and the early 3<sup>rd</sup> century (Šarić 1979–1980: 139, 141, T. VII: 7).

A vessel was found in a grave of a female on Baláca site, the author describes it as a bowl, but it looks like the plates of the first type (Csirke 2004: 245–246, 250–253, Abb. 4; 5: 1, 4; 6: 3; 7: 3). In Lower Pannonia, these plates were found in Mursa and Cibalae, only with a little bit more rounded walls (Vikić-Belančić 1970: 167, T. VIII: 7; Brukner 1981: 85, T. 65: 10–11; Ožanić 2004a: 84, T. 16: 12, T. 71: 3/4), they were also found in a grave in Mačvanska Mitrovica (Ercegović-Pavlović 1980: 9, Pl. X: 8), Babarac (Fazekas 2007: 119, T. 20: 160), Sirmium (Parović-Pešikan 1973: 24, T. XVIII: 1) and Matrica (Topál 1981: 34, 54, XXVII – grob 80, 1, L – grob 161, 3/4, 62, LVIII – grob 195, 2). Numerous plates of the first type were found in Ljubljana, where they date to the transition into the Modern Ages (Vičić 2002: 195, 198, T. 5: 10). The Pompeian plates and their imitations last longer, and they can be dated only by context. In the northern cemetery in *Emona*, bowls that correspond to the plates from this catalogue and of this type by their size and profile, were found in an incineration grave (Plesničar-Gec 1972: 20, T. XI. Grave 42, 7, 12). Some of them, found on the incineration cemetery, are described as plates and also fit this type (Plesničar-Gec 1972: 27, T. XX, Grave 85, 13). This type of plates is present on the Hungarian site of Zalalövő as well (Cserményi 1977: 246, 264, abb. 60, 10). There are analogies in Tekija, in Gornja Mezija (Cermanović-Kuzmanović 2004: 147–149, kat. 8). The plates of the first type are also present in Dacia (Gudea 1996: 214–216, T. XXIII: 1, 4, T. XXIV: 1).



Sl. 155 Tanjuri tip 2  
Fig. 155 Type 2 plates

ili u bližoj okolici, moguće je da su tanjuri T2 izrađeni od strukture VKJ 23 s nekog drugog mjesta u provinciji. Njihova kvaliteta je daleko veća.

U Gornjoj Panoniji tanjuri tipa T2 pronađeni su na groblju u Stenjevcu (Gregl 1989: 21, T. 10: 5), Sisku (Bugar 2000: 25, T. XI: 5–6, T. XII–XIII; Katavić 2001: 29, T. VII–VIII; Kordić 2001: T. 14–18; Wiewegh 2001: 95, T. IX. 5, 9–12, T. 10; Vidošević 2003: 17, T. 7: 3) i Turopoljskom lugu iz druge polovine 1. i 2. stoljeća (Koščević, Makjanić 1986–1987: 45, T. XIII: 147). Ovakav tanjur pronađen je i na mađarskim lokalitetima Zalalövő (Cserményi 1977: 246, 262, abb. 56, 29) i Fertőrákos (Gabler 1973: 154, 155, Abb. 12: 2–3), na kasnoantičkom naselju datiranom u 4. i početak 5. st. (Medgyes 2002: 116, T. XI: 95, 234). Ovakvi tanjuri pronađeni su u podrumu rimske vile na lokalitetu Baláca i datirani su u 2. i u početak 3. st. (Bíróné et al. 1992: 173, Abb. 47: 3–8). Na sjevernom groblju u Ljubljani pronađen je veliki broj zdjela koje profilom i dimenzijama odgovaraju tanjurima iz ovog kataloga. U promjeru su nešto veći, a nagib stijenki, ravno dno i profilacija oboda odgovaraju tanjurima iz ovog kataloga. Pronađeni su u paljevinskim (Plesničar-Gec 1972: 19, 25, 34, 46, T. IV-Grob 15, 12, T. VIII-Grob 31, 10, 12, 16, T. XVIII-grob 73, 4, T. XXXV-Grob 132, 6, T. LVIII-Grob 208: 2, 3), ali i u skeletnim grobovima (Plesničar-Gec 1972: 23, T. XIV: Grob 57: 13). U paljevinskom grobu 149 s novcem Tiberija pronađen je pladanj s nagibom stijenke i profilacijom oboda kakve imaju tanjuri u ovom katalogu (Plesničar-Gec 1972: 37, T. XLI: 4). U dječjem skeletnom grobu 187 pronađena je zdjela s novcima Vespazijana i Kara zdjela koja dnom, nagibom stijenki i profilacijom oboda odgovara ovim tanjurima (Plesničar-Gec 1972: 43, T. LII: 18). U Donjoj Panoniji tanjuri T2 tipa pronađeni su u Cibalama (Brukner 1981: 86, T. 65: 17; Ožanić 2004a: 85, T. 62: 7, 10; T. 15: 2; T. 16: 13; T. 17: 15; T. 71: 1, 5; T. 15: 3), Vukovaru, Sirmiju, Vojki, (Parović-Pešikan 1973: T. XVI: 7; Brukner 1981: 86, T. 65: 12–16), Babarcu (Fazekas 2007: 115, T. 17: 109), Matrici (Topál 1981: 43, XXXVIII-grob 114: 8). Tanjuri ovakve profilacije pronađeni su i u Gornjoj Meziji u Diani (Cvjetičanin 1996: 96, T. 2. III: 21). Tanjuri ovakve i slične profilacije nalaze se u lokalnim imitacijama i na drugim lokalitetima kao što je *Aquincum*, a datirani su u treću četvrtinu 2. st. (Topál 1993: 15, Pl. 14. grob 15–16. 2) ili drugu polovinu 2. st. (Topál 1993: 18, 25, Pl. 20 grob 24. 2, Pl. 35 grob 40. 2).

Prema analogijama, kontekstu nalaza i <sup>14</sup>C datumima nemoguće je izdvojiti tipove koji su zastupljeni u kraćem vremenskom razdoblju (sl. 156). Čini se da su tanjuri kao italjski oblik došli na prostor Gornje Panonije dolaskom Rimljana i da su u svom obliku s različitim odstupanjima zastupljeni do kraja antike. Po broju lokaliteta na kojima se javlja T2 tip tanjura jasno je da je on kao oblik prisutan na širem području Gornje i Donje Panonije. Sama struktura pojedinih tanjura upućuje da su neki od njih (struktura VKJ 2) izrađeni na lokalitetima na kojima su i pronađeni te se radi o lokalno proizvedenim tanjurima.

An examination of the analogue material and the results of <sup>14</sup>C analysis of objects from Virovitica Kiškorija south, where this type of plates is present, clearly shows the continuity of the type from the 1<sup>st</sup> to the 4<sup>th</sup> century (fig.156).

The second type of plates, **T2** (Pl. 4: 5; Pl. 11: 3; Pl. 21: 4) (29, 87, 184 (?)), has the same features and it can be distinguished from the first type by a thickened rim that is emphasised on the inner wall of the vessel (fig.155). The diameter of the rim is 13-40 cm and the provincial production dates from 1<sup>st</sup> to the 4<sup>th</sup> century (Brukner 1981: 86). Cat. Nos. 29, 87 and 184 (?) belong to this group. They all have a slip on the inner wall of the plate and they may have been used for cooking and serving of liquid foods, same as the plates from the previous group. The plate Cat. No. 87 was found in an enclosed unit and dates from the year 239 to 361, based on <sup>14</sup>C analysis. Plates T2 are made of VKJ 2 fabric (Cat. Nos. 87, 29), and they have a less emphasised rim than the plates made of VKJ 23 fabric (Cat. No. 174). As most of the ceramic vessels from Virovitica Kiškorija south are made of VKJ 2 fabric and, as it is assumed, they were produced at the site or in its vicinity, it is possible that the T2 plates, made of VKJ 23 fabric, were made elsewhere in the province. They are of a much higher quality.

The T2 type plates were found on the cemetery in Stenjevec, in Upper Pannonia (Gregl 1989: 21, T. 10: 5), Sisak (Bugar 2000: 25, T. XI: 5–6, T. XII–XIII; Katavić 2001: 29, T. VII–VIII; Kordić 2001: T. 14–18; Wiewegh 2001: 95, T. IX. 5, 9–12, T. 10; Vidošević 2003: 17, T. 7: 3) and Turopoljski lug dating to the second half of the 1<sup>st</sup> and the 2<sup>nd</sup> century (Koščević, Makjanić 1986–1987: 45, T. XIII: 147). A plate of this kind was also found on Hungarian sites of Zalalövő (Cserményi 1977: 246, 262, abb. 56, 29) and Fertőrákos (Gabler 1973: 154, 155, Abb. 12: 2–3), in a Late Antiquity settlement that dates to the 4<sup>th</sup> and the early 5<sup>th</sup> century (Medgyes 2002: 116, T. XI: 95, 234). Plates like this were also found in the cellar of a Roman villa on Baláca site and they date to the 2<sup>nd</sup> and the early 3<sup>rd</sup> century (Bíróné et al. 1992: 173, Abb. 47: 3–8). Many bowls that correspond to the plates from this catalogue by profile and size were found in the northern cemetery in Ljubljana. They are larger in diameter, but they have the same curvature of walls, flat base and the profile of the rim like the plates from this catalogue. They were found in incineration (Plesničar-Gec 1972: 19, 25, 34, 46, T. IV-Grave 15, 12, T. VIII-Grave 31, 10, 12, 16, T. XVIII-grave 73, 4, T. XXXV-Grob 132, 6, T. LVIII-Grob 208: 2, 3) and in skeleton graves (Plesničar-Gec 1972: 23, T. XIV: Grave 57: 13). In the incineration grave 149, together with coins of Emperor Tiberius, a tray with a curvature of the wall and a profile like the plates in this catalogue was found (Plesničar-Gec 1972: 37, T. XLI: 4). A bowl with the coins of Emperor Vespasian and Emperor Carus was found in a skeleton grave of a child, which corresponds to these plates by its curvature of the wall and the profilation of the rim (Plesničar-Gec



TIP POSUDE	1. st.	2. st.	3. st.	4. st.	5. st.
T 1 					
T 2 					

Sl. 156 Tipološko-kronološka tabela zdjela  
Fig. 156 Typological and chronological table of plates

### 3.3.4. Poklopci (lat. *Operculum*; eng. *lid*; njem. *Deckel*; tal. *coperchio*; fra. *couvercle*)

Prema Hilgersu poklopci su u osnovi prilično jedinstvenog oblika i neukrašeni su, bez obzira radi li se o predmetima izrađenima od keramike ili stakla (Hilgers 1969: 71). Osnovno za poklopac je to što je on služio za prekrivanje posuda te se prilagođavao njihovom obodu odnosno, kako su se mijenjali obodi posuda tako su se mijenjali i obodi poklopaca kako bi što bolje vršili svoju funkciju. Dakle, njihov oblik ovisi o loncima, zdjelama, amforama i drugim posudama koje su mogli pokrivati, odnosno o njihovom razvojnom putu, utjecajima i područjima na kojima ih nalazimo. Što se tiče grube keramike domaće izrade, njihov oblik uvelike ovisi o prapovijesnoj tradiciji na koju se gruba kućna keramika u pravilu uvijek oslanja. Također, ona može ovisiti i o uvoznim keramičkim oblicima koji su se u domaćim radionicama imitirali. Poklopci su keramički oblik koji je prvenstveno morao zadovoljiti svoju svrhu – pokriti posudu. To su predmeti koji su imali isključivo utilitarnu ulogu, a ne dekorativnu ili simboličnu.

U objektima koji su <sup>14</sup>C analizom ugljena datirani u 3.–4. stoljeće, pronađeni su poklopci ravnog oboda. Poklopci o kojima se raspravlja imaju ravno dno i čepaste drške i tipološki su međusobno vrlo slični. Ono što ih ukratko opisuje je jednostavnost oblika. Oni su bili namijenjeni pokrivanju lonaca pri kuhanju, a kako lonci imaju jednostavno profilirane obode, tome odgovaraju i sami poklopci svojom jednostavnošću. U nastojanju da se pronađu analogni predmeti za poklopce koji se tu opisuju bilo je potrebno pregledati literaturu prostora izvan Panonije, a moguće je da se poklopci zbog svoje jednostavne primjene i oblika pojavljuju podjednako u različitim dijelovima Carstva. Svi pronađeni poklopci imaju ravan neprofiliran obod, i u tome se vidi njegova jednostavnost i funkcionalnost. Poklopci s ravnim obodom podijeljeni su na tri tipa koji se međusobno razlikuju po nagibu bočnih stijenki.

Prvi tip **P1** (T. 1: 2; T. 8: 8; T. 11: 4; T. 14: 3, 10; T. 20: 14), čine poklopci kat. br. 2, 55, 88, 101, 107, 180 čija je stijenka blago utisnuta prema unutrašnjosti poklopca, odnosno njegove bočne stijenske su blago spljoštene na dijelu bliže obodu (sl. 157). Analogni poklopci grube fature pronađeni su u Ljubljani na položaju Gornji trg 15 (Vičić

1972: 43, T. LII: 18). In Lower Pannonia, the type T2 plates were found in *Cibalae* (Brukner 1981: 86, T. 65: 17; Ožanić 2004a: 85, T. 62: 7, 10; T. 15: 2; T. 16: 13; T. 17: 15; T. 71: 1, 5; T. 15: 3), Vukovar, Sirmium, Vojka, (Parović-Pešikan 1973: T. XVI: 7; Brukner 1981: 86, T. 65: 12–16), Babarac (Fazekas 2007: 115, T. 17: 109) and *Matrica* (Topál 1981: 43, XXXVIII-grave114: 8). The plates of this profile were also found in Moesia Superior in *Diana* (Cvjetičanin 1996: 96, T. 2. III: 21). The plates of this and similar profilation are present in the local imitations and on other sites like *Aquincum* and they date to the third quarter of the 2<sup>nd</sup> century (Topál 1993: 15, Pl. 14. grave 15–16. 2) or the second half of the 2<sup>nd</sup> century (Topál 1993: 18, 25, Pl. 20 grave 24. 2, Pl. 35 grave 40. 2).

According to analogies, the context of the finds and <sup>14</sup>C dates, it is impossible to separate types that are present only in shorter periods (fig. 156). It appears that the plates came to the area of Upper Pannonia as an Italic shape with the Romans' arrival. They are present in their shape with different variations until the end of Antiquity. Evidently, by the number of sites where it appears, the T2 type of plates is present as a shape on a larger area of the Upper and the Lower Pannonia. The fabric of certain plates suggests that some of them (fabric VKJ 2) were produced on the sites where they were found, so they are locally produced plates.

### 3.3.4. Lids (Lat. *Operculum*; Ger. *Deckel*; Ital. *coperchio*; Fr. *couvercle*)

According to Hilgers, the lids basically have a fairly unique shape and no decorations, whether the objects are made of ceramic or glass (Hilgers 1969: 71). The lid was primarily used to cover the vessels and it adjusted to their rim. As the rims of the vessels changed, the rims of the lids changed to better serve their purpose. Thus, their shape depends on pots, bowls, amphorae and other vessels which they could cover, that is on their developmental phases, influences and areas where we find them. Concerning the domestically produced coarse ceramics, their shape relies a lot on the prehistoric tradition, on which the coarse domestic ceramics usually depends. It can also depend on the imported ceramic shapes, which were imitated



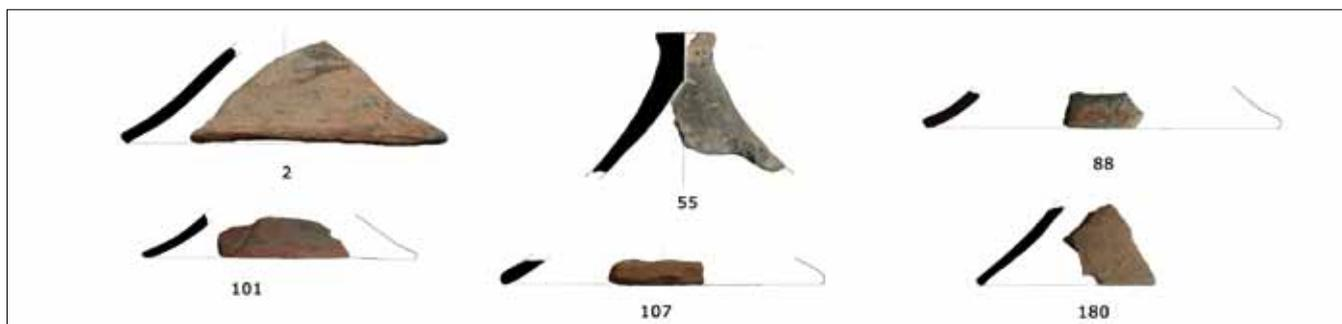

Sl. 157 Poklopci tip 4  
Fig. 157 Type 1 lids

1993: 165, T. 22: 4–5). Sličan poklopac pronađen je u Serminu uz jarak uz rijeku Rižan, gdje je datiran u prvu polovinu 1. st. po. Kr. (Horvat 1997: 29, T. 51: 3). Poklopac ovog tipa od sivo pečene gline pronađen je u Emoni i pripada najstarijoj građevinskoj fazi (Plesničar-Gec 2006: T. 44: 16). Analogije postoje i na lokalitetu Krvavići Boškina (Bekić 2007: 106, 174, T. 8: 8), u Singidunumu gdje je datiran od 2. do početka 5. stoljeća (Bojović 1977: 115 br. 631, 634, T. LXXI: 631, 634; Nikolić-Đorđević 2000: 155, tip VIII/4, 157, tip VIII/10; Nikolić-Đorđević 2002: 228–229, sl. 7: 1), Tekiji (Tomović 1984: 351, T. III: 15), Mitrovačkim Livadama - rimskom naselju iz 1. i početka 2. stoljeća (Brukner 1995b: 142, 146, 153, T. I: 9), na Gomolavi gdje je pronađeno više primjeraka i tu su datirani u 1. st., te se njihov oblik tumači kao nastavak latenske tradicije (Brukner 1992: 26, 33, T. 18: 115). Na Liskovcu su također zastupljeni i datirani u drugu polovicu 1. st. (Ožanić Roguljić 2009: T. 8: 11–13). Poklopci ovog tipa ukrašeni metličastim ukrasom pronađeni su na Drenju (Drenje 1987: 29, 37–38, T. 6: 1–6). U Bad Wimpfenu (*vicus, Germania Superior*) također, pronađeni su poklopci ovog tipa (Czys et al. 1981: 32, T. 38: 476). U Mađarskoj na lokalitetu Szakály (lokalitet mlađeg željeznog doba koji živi u kontinuitetu do kraja kasne antike, prožet snažnim tradicijama vidljivima u materijalu i načinu života), u zapuni zemunice koja je datirana u 2. st. po. Kr, pronađen je ovakav poklopac (Gabler, Ottományi 1990: 170, Fig. 8, 10, 188) i u ranocarskom tumulu na lokalitetu Zalalövő (Müller 1971: fig. 12: 8). Nedaleko od Savarije, u naselju koje je datirano od 4. do u početak 5. st. pronađeno je više sličnih poklopaca, međutim kod njih je utisnuti dio kose stijenke jače profiliran (Medgyes 2002: 116, T. XII: 28, 129, 595). Velik broj poklopaca, među kojima je prisutan i ovaj tip, pronađen je u podrumu rimske vile na lokalitetu Baláca, a koji se s drugim keramičkim materijalom tog podruma datiraju u 2. i početak 3. st. (Bíróné et al. 1992: 167, Abb. 41: 3, 10, 14, 15, 20). P1 tip poklopca dakle u primjeni je na širokom području od 1. pa sve do u 5. stoljeće (sl. 160).

Drugom tipu **P2** (T. 1: 8–9; T. 2: 8; T. 11: 5; T. 23: 1), (8–9, 17, 89, 203) pripadaju poklopci koji imaju kose stijenke bez zaobljenja (sl. 158). Analogije za drugi tip poklopaca nalazimo u Ptuju u sloju između grobova (Tušek 1993: 402, T. 20),

in domestic workshops. The lids are primarily a ceramic shape that had to serve its function – cover the vessel. These are the objects that had a solely functional role and not a decorative or a symbolic one.

Lids with a straight rim were found in the structures which are dated to the 3<sup>rd</sup>–the 4<sup>th</sup> century by <sup>14</sup>C analysis of coal. Those lids have a straight base and knob handles, and they are typologically very similar. In short, they can be described through the simplicity of shape. They were used for covering the pots while cooking. Because the pots have simply profiled rims, the lids themselves fit them with their simplicity. To be able to find analogue objects for the lids described here, it was necessary to look through the literature about the area outside Pannonia. It is also possible that lids are equally present in different parts of the Empire, due to their simple use and shape. All of the found lids have a straight unprofiled rim, from which we can see its simplicity and functionality. Lids with a straight rim are divided into three types, different in the curvature of side walls.

The first type, **P1** (Pl. 1: 2; Pl. 8: 8; Pl. 11: 4; Pl. 14: 3, 10; Pl. 20: 14), consists of the lids Cat. Nos. 2, 55, 88, 101, 107, 180. Their wall is slightly pressed in toward the inside of the lid, that is, its side walls are slightly flattened on the part closer to the rim (fig. 157). Analogue lids of coarse fabric were found on the position Gornji trg 15 in Ljubljana (Vičić 1993: 165, T. 22: 4–5). A similar lid was found along a ditch near Rižan River in Sermin, where it dates to the first half of the 1<sup>st</sup> century (Horvat 1997: 29, T. 51: 3). This type of lid, made from grey fired clay and which belongs to the eldest construction phase, was found in *Emona* (Plesničar Gec 2006: T. 44: 16). There are also analogies on Krvavići Boškina site (Bekić 2007: 106, 174, T. 8: 8), in *Singidunum* where it was dated from the 2<sup>nd</sup> to the early 5<sup>th</sup> century (Bojović 1977: 115 br. 631, 634, T. LXXI: 631, 634; Nikolić-Đorđević 2000: 155, tip VIII/4, 157, tip VIII/10; Nikolić-Đorđević 2002: 228–229, sl. 7: 1), Tekija (Tomović 1984: 351, T. III: 15), Mitrovačke Livade – Roman settlement from the 1<sup>st</sup> and the early 2<sup>nd</sup> century (Brukner 1995b: 142, 146, 153, T. I: 9), on Gomoglava, where several examples were found that date to the 1<sup>st</sup> century and their shape

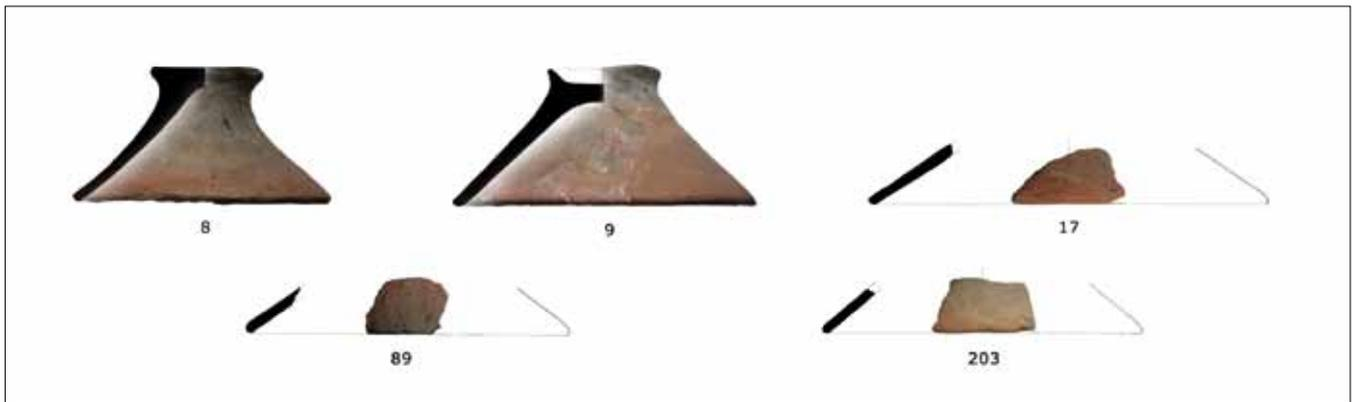

Sl. 158 Poklopci tip 2  
Fig. 158 Type 2 lids

u Hajdini gdje su slični poklopci pronađeni uz peć i ispod nje, međutim ovi primjerci su rađeni na kolu (Strmčnik-Gulić 1993: T. 7–8; T. 10: 3, 5–6, 11). Zatim, u drugoj fazi naseljavanja: kasnorepublikansko-rano augustovsko vrijeme na lokalitetu Gornji trg 30 u Ljubljani (Vičić 1994: 30, 37, T. 3: 12). Na Gornjem trgu 3 u Ljubljani pronađen je također poklopac ravnog oboda kosih stijenki (Vičić 2002: 196, 200, T. 10, 12), a datira se u drugu polovicu 1. i u 2. st. po. Kr. te na forumu u Ljubljani gdje taj poklopac ima premaz, a pripada najstarijoj građevinskoj fazi (Plesničar-Gec 2006: T. 44: 4). Poklopci ravnog oboda i kosih stijenki pronađeni su u grobovima u Ptuj u paljevinskom grobu 26 (Kujundžić 1982: 16, T. 3: 9), 132 (Kujundžić 1982: 26, T. 12: 3), i 334 (Kujundžić 1982: 50, T. 26: 2). Brukner na primjerima poklopaca iz Donje Panonije izdvaja više tipova, a ovoj grupi analogiju predstavlja tip 3a kojeg ona datira od kraja 1. do sredine 3. stoljeća i potječe iz Sirmija (Brukner 1981: 110, 161, T. 129: 9). Spomenuti primjerak ima i čepastu dršku. Sličan je kataloškom broju 8. Jednostavne poklopce koničnog oblika, ravnog oboda zaobljenog ruba s čepastom drškom, Bónis navodi kao tip poklopca koji se u Panoniji javlja za pokrivanje tronožaca (Bónis 1942: 56, T. XV, XXIV, XXI). Analogije postoje i u Tekiji (Tomović 1984: 351, T. III: 16) te u Singidunumu, iako je navedeni primjerak izrađen od pročišćene gline (Ivanišević, Nikolić-Đorđević 1997: 99, sl. 31: 4; Nikolić-Đorđević 2000: 155, tip VIII/4), Iloku (Jelinčić 2003: 82, T. 3: 18), Gorziju (Kocztur 1994: 94–95, Abb. 60: 7). Posljednji je primjerak zapravo najbliži poklopcima s lokaliteta Virovitica Kiškorija jug, a važno je i to što potječe iz zemunice i s lokaliteta ruralnog karaktera. Poklopac iz Gorzija datira se u 2.–3. st. Takav poklopac se, međutim na lokalitetu Budakalász – Luppá Csárdai datira u kraj druge polovine 4. st. (Ottományi 2004: 288–289, T. VI: 7). Poklopac tipa 2 pronađen je na kasnoantičkoj rustičnoj vili (3.–4. st.) na lokalitetu Zlatara – Ruma (Brukner 1995b: 138, 146, T. V: 49), ali i u domorodačkom naselju Pećinci u Srijemu iz 1. st. po. Kr. (Brukner 1995a: 99, 107, 125, T. XV: 152, 135, T. XXV: 10), domorodačkom naselju Žirovac – Ruma u Srijemu gdje se datira u sredinu i drugu polovinu 1. st. (Brukner

is interpreted as a continuation of the La Tène tradition (Brukner 1992: 26, 33, T. 18: 115). They are as well present on Liskovac and they date to the second half of the 1<sup>st</sup> century (Ožanić Roguljić 2009: T. 8: 11–13). This type of lids with brushed decorations were found on Drenje (Drenje 1987: 29, 37–38, T. 6: 1–6) as well as on Bad Wimpfen (vicus, Germania Superior) (Czys et al. 1981: 32, T. 38: 476). On Szakály site (a site from the early Iron Age, which is continuously present until the late Antiquity, with strong traditions visible throughout the material and the lifestyle) in Hungary, a lid like this was found in the backfill of a pit-house, which dates to the 2<sup>nd</sup> century (Gabler, Ottományi 1990: 170, Fig. 8, 10, 188) and in the tumulus from the early Empire on Zalalövő site (Müller 1971: fig. 12: 8). Not far from *Savaria*, in the settlement which dates from the 4<sup>th</sup> to the early 5<sup>th</sup> century, several similar lids were found. However their impressed part of the oblique wall is more profiled (Medgyes 2002: 116, T. XII: 28, 129, 595). Many lids, including lids of this type, were found in the basement of a Roman villa on Baláca site and they together with the other ceramic material from that basement date to the 2<sup>nd</sup> and the early 3<sup>rd</sup> century (Bíróné et al. 1992: 167, Abb. 41: 3, 10, 14, 15, 20). Thus, the P1 type lids are in use in a large area from the 1<sup>st</sup> and to the 5<sup>th</sup> century (fig. 160).

The lids with oblique walls without the rounding belong to the second type, **P2** (Pl. 1: 8–9; Pl. 2: 8; Pl. 11: 5; Pl. 23: 1), (8–9, 17, 89, 203) (fig. 158). Analogies for the second type can be found in Ptuj, in the layer between the graves (Tušek 1993: 402, T. 20) and in Hajdina, where similar lids were found next to a kiln and behind it, only these examples are made on a wheel (Strmčnik-Gulić 1993: T. 7–8; T. 10: 3, 5–6, 11). Subsequently, in the second phase of the settlement: late Roman Republic-early Augustan Age on the Gornji trg site in Ljubljana (Vičić 1994: 30, 37, T. 3: 12). On Gornji trg 3 in Ljubljana, a lid with a straight rim, that has oblique walls, was found (Vičić 2002: 196, 200, T. 10, 12), it dates to the second half of the 1<sup>st</sup> and the 2<sup>nd</sup> century. Also on the forum in Ljubljana, where that type of a lid has slip and belongs to the oldest construction

1995a: 100, 108, 128, T. XVII: 185), domorodačkom naselju Mitrovačke livade (Brukner 1995b: 102, 109, 131, T. XXI: 210) i Selištu (Dautova–Ruševljan 2003: 32, 86, T. LIII: 3). Ovakav tip poklopca s drukčijom drškom pronađen je u velikom broju u Vinkovcima, različitim dimenzija. Datiraju se od 2. do 4. st. (Ožanić 2008: 188–189). Poklopci tipa 2 pronađeni na Drenju ukrašeni su metličastim ukrasom, a također su izrađeni od grube fature (Drenje 1987: 38, T. 6: 8–12). Ovaj tip poklopca datiran je u 2. i početak 3. stoljeća na lokalitetu Baláca, gdje su u velikom broju pronađeni u podrumu rimske vile (Bíróne et al. 1992: 167–68, Abb. 41: 4, 25, 31).

Kataloški brojevi 8 i 9, 89 pronađeni su u objektima koji se datiraju u 3.–4. stoljeće (<sup>14</sup>C datumima ili drugima nalazima koji su pronađeni u tim objektima), a analogni nalazi pokazuju kako se on javlja i ranije, već od 1. stoljeća.

Treći tip **P3** (T. 11: 6, T. 16: 3; T. 23: 2) poklopci su čije su stijenke zaobljene prema vanjskoj strani (kat. br. 90, 124, 204) (sl. 159). Analogni poklopac, posebno za kat. br. 90, postoji u grobu 157 na lokalitetu Beletov vrt – Novo Mesto (Knez 1992: 57, T. 55: 6). Analogni poklopac trećem tipu primjerak je pronađen u Sirmiju i datira se u 1. st. (Brukner 1981: 110, 161, T. 130: 12). Analogije postoje u Singidunumu (Bojović 1977: 115, br. 632, T. LXXI: 632; Nikolić-Đorđević 2002: 228–229, sl. 7: 4) i rimskom naselju Mitrovačkim Livadama gdje su datirani u 1. i početak 2. st. (Brukner 1995b: 142, 146, T. I: 10). Ovakav tip poklopca sive boje javlja se i na lokalitetu Zalalövő u Mađarskoj (Cserményi 1977: 246, 266, Abb. 63: 3).

Kataloški broj 90 datiran je <sup>14</sup>C analizom od 239.–361. godine, a prema analogijama je vidljivo kako se ovaj tip poklopca javlja već od 1. stoljeća (sl. 160).

Svi poklopci koji su pronađeni imaju čepaste ručke koje su različito oblikovane (T. 23: 4–5). Podijeljeni su prema oblikovanju ručki koje su različito oblikovane i naglašene. Ručke mogu imati konično udubljenje (9, 56) ali mogu biti i ravne (55, 116, 204–206, 184).

Poklopac s ravnom čepastom ručkom koja je slično oblikovana, pronađen je u grobu 85 na lokalitetu Beletov vrt u Novom Mestu (Knez 1992: 43, T. 32: 6). Razlika je u tome što su stijenke spomenutog poklopca narebrene. Poklopci s čepastim drškama koje su slične tipovima s Virovitice Kiškorijske nalaze se i u Sisciji (Wiewegh 2001: 95, 113, T. VIII; Vidošević 2003: 19, 37, T. 10: 1–3). Čepaste ravne drške pronađene su i na lokalitetu Krvavići – Boškina te su izrađene od grublje gline s dosta primjesa (Bekić 2007: 106,

phase (Plesničar-Gec 2006: T. 44: 4). Lids with a straight rim and oblique walls were found in the graves in Ptuj, on the incineration cemetery 26 (Kujundžić 1982: 16, T. 3: 9), 132 (Kujundžić 1982: 26, T. 12: 3), and 334 (Kujundžić 1982: 50, T. 26: 2).

Brukner singles out several types from the lid examples from Lower Pannonia. The analogy for this group is the type 3a from Sirmium, which dates from the late 1<sup>st</sup> to the mid-3<sup>rd</sup> century (Brukner 1981: 110, 161, T. 129: 9). The mentioned example has a knob handle. It is similar to catalogue number 8. Bónis states the simple lids of conical shape with a straight rim, which has a rounded edge, with a knob handle, as a type of the lids used to cover tripods in Pannonia (Bónis 1942: 56, T. XV, XXIV, XXI). Analogies are also present in Tekija (Tomović 1984: 351, T. III: 16) and in Singidunum, although the mentioned example is made of the refined clay (Ivanišević, Nikolić-Đorđević 1997: 99, sl. 31: 4; Nikolić-Đorđević 2000: 155, tip VIII/4), Ilok (Jelinčić 2003: 82, T. 3: 18) and Gorzija (Kocztur 1994: 94–95, Abb. 60: 7).

The last example is actually the most similar to the lids from Virovitica Kiškorijska south site and it is important that it is from a pit-house and from a rural site. The lid from *Gorsium* dates to the 2<sup>nd</sup>–the 3<sup>rd</sup> century. However, this kind of lid from Budakalász – Lupa Csárdai site dates to the second half of the 4<sup>th</sup> century (Ottományi 2004: 288–289, T. VI: 7). A type 2 lid was found in a Late Antique villa rustica (3<sup>rd</sup>–4<sup>th</sup> century) on Zlatac - Ruma site (Brukner 1995b: 138, 146, T. V: 49), as well as in the native settlement of Pećinci in Srijem from the 1<sup>st</sup> century (Brukner 1995a: 99, 107, 125, T. XV: 152, 135, T. XXV: 10), in the native settlement of Žirovac - Ruma in Srijem, where it dates to the middle and the second half of the 1<sup>st</sup> century (Brukner 1995a: 100, 108, 128, T. XVII: 185), in the native settlement of Mitrovačke livade (Brukner 1995b: 102, 109, 131, T. XXI: 210) and in Selište (Dautova-Ruševljan 2003: 32, 86, T. LIII: 3). Numerous lids of this type, but with a different handle, were found in various sizes, in Vinkovci. They date from the 2<sup>nd</sup> to the 4<sup>th</sup> century (Ožanić 2008: 188–189). The type 2 lids with brushed decoration were found in Drenje, they were made from a coarse fabric (Drenje 1987: 38, T. 6: 8–12). This type of lid on Baláca site is dated to the 2<sup>nd</sup> and the early 3<sup>rd</sup> century, where many were found in the basement of a Roman villa (Bíróne et al. 1992: 167–68, Abb. 41: 4, 25, 31).

Catalogue numbers 8, 9 and 89 were found in structures that date to the 3<sup>rd</sup>–the 4<sup>th</sup> century (according to <sup>14</sup>C dates



Sl. 159 Poklopci tip 3

Fig. 159 Type 3 lids



TIP POSUDE	1. st.	2. st.	3. st.	4. st.	5. st.
 P 1	—————				
 P 2	—————				
 P 3	—————				

Sl. 160 Kronološko-tipološka tabela poklopaca  
Fig. 160 Typological and chronological table of lids

182, T. 17: 11). Kataloški broj 186 ima čepastu dršku koja je vrlo široka, a prema Bónis to su stariji oblici i jedan takav primjer datiran je novcem Klaudija iz groba (Bónis 1942: 56). Kataloški brojevi 8 i 9, 55, 116, pronađeni su u zapunama objekata datiranih u kasnu antiku, u razdoblje od 3. do 4. stoljeća, predmetima pronađenima u tim objektima. Čepasta udubljena drška pronađena je također u Sisciji (Vidošević 2003: 19, 37, T. 10: 4) i slični drški kataloškog broja 56. Velik broj čepastih drški s udubljenjem poklopca grube fature pronađen je na lokalitetu Drenje (Drenje 1987: 29, 38, T. 6: 13–25). Oba primjera s lokaliteta Virovitica Kiškorija jug pronađena su u objektima datiranim u 3.–4. Stoljeće, drugim nalazima iz tih objekata.

Na kraju se može zaključiti da su u ovdje zastupljeni jednostavni oblici poklopaca od nepročišćene gline, meke fature, ravnog oboda i sa čepastim drškama. Navedeni oblici javljaju se tijekom cijelog trajanja naselja i bez obzira na njihove male tipološke razlike, nije ih moguće vremenski ograničiti. To su potvrdile i analogije iz Gornje Panonije i susjednih provincija (sl. 160).

**3.3.5. Tarionici** (lat. *mortarium*, njem. *Reibschale*, eng. *mortar*, tal. *mortaio*, fra. *mortier*)

Tarionici su svojim oblikom nalik zdjelama zbog svoje dubine i široko razgrnutog oboda, koji je ponekad lučno savijen. Unutrašnja strana ruba zaobljena je, zadebljana, te naglašena rebrom koje često prelazi u izljev. Pored izljeva, okomito na sam rub, može se nalaziti pečat proizvođača ili radionice. U svježu glinu, prilikom izrade tarionika utiskivala bi se zrna pijeska kako bi površina nakon pečenja bila hrapava. To je omogućavalo lakše mrvljenje i miješanje hrane, a u tu svrhu služio je kameni, keramički ili metalni tučak *pistillum*. Ta ogrubljenost površina specifična je upravo za tarionike te omogućava da se tarionici kao keramički oblik prepoznaju među sitnim ulomcima. Poznat je primjerak tučka koji je izrađen od drva, a pronađen je u kontekstu bunara. Stijenke tarionika su debele, a dno je široko, što je

or other finds from those structures). Analogue finds indicate that it was present even earlier, already in the 1<sup>st</sup> century.

The third type, **P 3** (Pl. 11: 6, Pl. 16: 3; Pl. 23: 2), lids have outward rounded walls (Cat. Nos. 90, 124, 204) (fig. 159). There is an analogue lid, specially for Cat. No. 90, in the grave 157 on Beletov vrt - Novo Mesto site (Knez 1992: 57, T. 55: 6). The example found in *Sirmium*, which dates to the 1<sup>st</sup> century, is analogue to the third type (Brukner 1981: 110, 161, T. 130: 12). Analogies are present in *Singidunum* (Bojović 1977: 115, br. 632, T. LXXI: 632; Nikolić-Đorđević 2002: 228–229, sl. 7: 4) and in the Roman settlement of Mitrovačke Livade, where they date to the 1<sup>st</sup> and the early 2<sup>nd</sup> century (Brukner 1995b: 142, 146, T. I. 10). This type of a grey lid is also present on Zalalövő site in Hungary (Cserményi 1977: 246, 266, Abb. 63: 3).

The catalogue number 90 dates from the year 239 to the year 361, based on <sup>14</sup>C analysis and it is visible throughout analogies, that this type of lids is already present from the 1<sup>st</sup> century (fig. 160).

All of the found lids have differently moulded knob handles (Pl. 23: 4–5). They are divided by the moulding of handles, which are differently moulded and emphasised. The handles can have a conic depression (9, 56), but they can also be flat (55, 116, 204–206, 184).

The lid with a flat knob handle, similarly moulded, was found in the grave 85 on Beletov vrt site in Novo Mesto (Knez 1992: 43, T. 32: 6). The difference is in the lid's walls, which are ribbed. The lids with knob handles, that are similar to the types from Virovitica Kiškorija south, are present in *Siscia* (Wiewegh 2001: 95, 113, T. VIII; Vidošević 2003: 19, 37, T. 10: 1–3). Flat knob handles were also found on Kravići – Boškina site, but they are made from a coarser clay with a considerable quantity of inclusions (Bekić 2007: 106, 182, T. 17: 11). Cat. No. 186 has a very broad knob handle; according to Bónis those are older forms and one of those examples is dated based on the coins of Emperor Claudius found in the grave (Bónis 1942: 56). Catalogue numbers 8 and 9, 55, 116 were found in backfills of the structures that dates to the Late Antiquity, in the period



omogućavalo da posuda bude stabilna (T. 1: 10). Tarionik je služio kao posuda za usitnjavanje začina i različitih krupnih sastojaka koji su se dodavali hrani, ali je još više služio kao zdjela za miješanje tijesta, umaka i krema tj. općenito za pripremu hrane. Sličan, ali manji oblik, korišten je također u medicinske svrhe, te nešto veći za miješanje žbuke i boja. Ove posude izrađivane su od metala, zlata, srebra, bakra, olova, keramike i kamena. Ovisno o njihovoj namjeni, različito se zovu: u domaćinstvu *mortarium*, u medicini *coticula*, u industriji i umjetnosti *pila*, a kao različite posude, različitog nazivlja za različite svrhe razlikuju ih i antički pisci. Potrebno je razlikovati i tarionike korištene za pripremu hrane od onih koji su služili kao stolno posuđe (Schörgendorfer 1942: 9; Baatz 1976–1977: 147; 151; Hilgers 1969: 68/70, 225, 226; Brukner 1981: 38; Zabehlicky-Scheffenegger 1998: 286, Fig. 10; Šimić-Kanaet 2003: 128; Cool 2006: 42; Hargis 2007: 7, 41–42, 44–46). Ovdje će biti riječ o tarionicima korištenima za pripremu jela.

O njihovoj važnosti u rimskoj kuhinji govori i činjenica što je za pripremu većine rimskih jela bio potreban upravo tarionik. Koliko god da je on važan i povezan s rimskom kuhinjom i svakodnevnicom, Baatz smatra da je porijeklo tarionika u Maloj Aziji (javlja se u Kilikiji u 11. st. pr. Kr.) i Grčkoj (gdje se javlja u 7. st. pr. Kr. a od 5. st. pr. Kr. je u masovnoj upotrebi). Potvrde za raniju upotrebu tarionika u odnosu na Rimljane nalazimo u grčkim naseljima, etrušćanskim grobnicama (reljefi, freske, ali i kao grobni prilog) te kod grčkih pisaca. Njegovu pojavu i pripremu jela koja su vezana uz tarionike pratimo od vremena grčke kolonizacije Male Azije, a Rimljani ih vjerojatno preuzimaju za vrijeme grčke kolonizacije Apeninskog poluotoka i osnivanja grčkih kolonija na poluotoku. Na Europskom kontinentu tarionici su kao oblik keramike vezani za rimski način pripreme hrane i njihova pojava veže se uz dolazak Rimljana na područje srednje Europe i Britanije. Primjena tarionika u rimskoj kuhinji izuzetno je važna i nezamjenjiva (Baatz 1976–1977: 150, 154–155; Slapšak 1989: 16; Hargis 2007).

*Mortarium* (tarionik) i *pistillum* (tučak) spominju se u pisanim izvorima zajedno, u kontekstu njihove raznolike primjene. U rimskoj antici, čini se da je tarionik najkorišteniji za pripremu hrane. Pored pisanih izvora, javljaju se prikazi tarionika na freskama, vazama, mozaicima i kamenim spomenicima, u različitim kontekstima: u domaćinstvu, u pogrebnom i zavjetnom kontekstu. Tučak – *pistillum* neophodan je, a tarionik bez njega nema smisla (Slapšak 1989: 16; Ožanić 2004b: 9; Hargis 2007).

Tarionici pripadaju jednom od najraširenijih tipova rimske keramike. Ranocarski tarionici imaju često crveno ili mramorizirano ukrašavanje na obodu. U 2. i 3. st. javlja se varijanta bez ukrašavanja. U Joviji i Jalžabet - Bartolovcu prisutni su zeleno glazirani tarionici s mramoriziranim ukrasom na obodu (Jelinčić 2009: T. 44. 1; T. 52. 3). Obod panonskih tarionika u 4. st. masovno se ukrašava glazurom

from the 3<sup>rd</sup> to the 4<sup>th</sup> century, based on the objects found in those structures. A depressed knob handle, similar to the catalogue number 56 handle, was also found in Siscia (Vidošević 2003: 19, 37, T. 10: 4). Numerous knob handles with a depression, of lids made of coarse fabric were found on Drenje site (Drenje 1987: 29, 38, T. 6: 13–25). Both examples from Virovitica Kiškorija south site were found in the structures dated, by other subjects found in them, to the 3<sup>rd</sup>–the 4<sup>th</sup> century.

We can conclude in the end, that in this area there are simple shapes of lids made of unrefined clay, soft fabric, with a straight rim and knob handles. Those shapes are present throughout the existence of the settlement. Regardless of their typological differences, it is impossible to limit them in time. This was confirmed by the analogies from the Upper Pannonia and the neighbouring provinces (fig.160).

**3.3.5. Mortars** (Lat. *mortarium*, Ger. *Reibschale*, Ital. *mortaio*, Fr. *mortier*)

Mortars have a similar shape to bowls, because of their depth and broadly flaring rim, which is sometimes arched. The inner side of the edge is rounded, thickened and emphasised by a rib, which often transitions into spout. Next to the spout, vertical to the edge, a manufacturer's or workshop's stamp can be found. During the production of a mortar, sand grains would be pressed into the fresh clay, so that the surface would be rough after the firing. This enabled easier food grinding and stirring which was also the purpose of a stone, ceramic or metal pestle *pistillum*. That rough surface is specific for mortars and it enables the identification of mortars as a ceramic shape among small fragments. A well-known example of a wood pestle was found in a well context. The mortar's walls are thick and it has a broad base, which enabled the vessel to be stable (Pl. 1: 10). It was used as a vessel for crushing of herbs and various larger ingredients which were added to the food, and even more as a bowl for the mixing of dough, sauce or cream i.e. in general for the food preparation. A similar, but smaller shape was used for medical purposes as well, and bigger ones for mixing of plaster and paint. These vessels were made of metal, gold, silver, copper, lead, ceramics or stone. Depending on their use, they have different names: in household *mortarium*, in medicine *coticula*, in industry and art *pila*. The Antique authors also use different terminology for them, according to their purpose. It is necessary to differ the mortars used for the preparation of food from the ones used as tableware (Schörgendorfer 1942: 9; Baatz 1976–1977: 147; 151; Hilgers 1969: 68/70, 225, 226; Brukner 1981: 38; Zabehlicky-Scheffenegger 1998: 286, Fig. 10; Šimić-Kanaet 2003: 128; Cool 2006: 42; Hargis 2007: 7, 41–42, 44–46). The mortars used for the



i grubim nanosom (Poczy 1957: 43). Raniji tarionici razlikuju se od kasnijih po tome što su masivniji, dok su mlađi manjih dimenzija i tanjih stijenki, a tijekom 2. i 3. stoljeća javljaju se prvi primjerci ukrašeni glazurom (Kreković 1998: 24; Cool 2006: 44). U Britaniji se raniji tarionici osim po masivnim stijenkama od mlađih razlikuju po jako zaobljenom obodu i slabo naglašenom rebro na obodu, dok mlađi tarionici imaju jako naglašeno rebro i obod koji je manje izražen (Bédoyère 2000: 40).

Masovna pojava glaziranih tarionika u toku srednjeg i donjeg Dunava upućuje na njihovu masovnu proizvodnju u 3. i 4. po. Kr., a tu se misli na područje Panonije. Lokalna proizvodnja tarionika je također morala biti prisutna jer je pregled materijala pokazao kako se analogni tarionici jako razlikuju u svojoj strukturi na pojedinim lokalitetima (Jelinčić 2009: T. 44: 1–2; T. 52: 3; T. 53; T. 76: 1; T. 114: 1; sl. 54–59; 114–116). Proizvodnja u Panoniji započinje u vrijeme Flavijevaca i Trajana (Petovij, Akvink), dok se u 3. i 4. stoljeću tarionici proizvode i u manjim lokalnim radionicama (Baatz 1976–77; Brukner 1981: 38; Gabler 1982: 100). Na dunavskom limesu, na području Đerdapa, glazirana keramika pa tako i glazirani tarionici javljaju se od posljednje četvrtine 3. st. (Cvjetičanin 1995: 29). U Petoviju je dokazana radionička djelatnost i proizvodnja tarionika, te su poznati i majstori koji su ih izrađivali. Ti tipovi tarionika javljaju se u velikom broju duž Drave i Dunava te su osim u Panoniji, zastupljeni i u Meziji (Istenič 1999: 191–202; Cvjetičanin 2003: 99; 2006: 21), međutim ti tipovi nisu zastupljeni na Virovitici Kiškoriji jug, prema dosadašnjim istraživanjima.

Tarionici su u ovom radu podijeljeni u tri tipa i to po oblikovanju njihova oboda. Izrađeni su svi od iste strukture keramike, a na unutrašnjoj stijenki imaju sačuvane utisnute kamenčice preko kojih je stavljana staklena glazura zelene boje. Tarionici koji su oblikom slični tarionicima s Virovitice Kiškorije jug, a glazirani su, susreću se u provincijama uz srednji i donji tok Dunava (usporedi tarionike kod Cvjetičanin 2003: 103; 2006: 26; Brukner 1981: T. 61). Za izradu tarionika bili su potrebni vješti i specijalizirani majstori (Cuomo di Caprio 1982: 213) ipak, njihova drukčija struktura, a i oblik, upućuju na proizvodnju na užem prostoru oko Kiškorije, a ne na provincijsku proizvodnju. Ostaje otvoreno pitanje gdje su točno proizvedeni pojedini tarionici.

Tip **Tr1** (T. 15: 12), kat br. 119. Radi se o tarioniku čiji je obod izvijen prema van i blago je lučno savijen (sl. 161). Reb-ro nije jako naglašeno te prelazi u izljev. Na obodu nema ukrasa i glazure, ona se nalazi samo na unutrašnjoj stijenki posude ispod rebra iznad utisnutih kamenčica. Glazura je zeleno maslinaste boje. Sličan tarionik pronađen je u Sisciji (Katavić 2001: 37, T. 14: 11; Wiewegh 2001: 96, T. XI–XII), te u šljunčari kod Koprivnice (Marković 1993: 27–28). Zeleno glazirani tarionik ovakve profilacije pronađen je u sloju na ranocarskoj nekropoli Kunovec Breg gdje se sami grobovi datiraju od 1.–2. st. (Demo 1982: 292, T. 24: 14). Tip je zastu-

preparation of food will be discussed here.

The fact that most of the Roman dishes were made using that kind mortars tells us about their significance in the Roman cuisine. Even though the mortars are important for the Roman cuisine and everyday life and connected to it, Baatz believes that they originate from Asia Minor (they are present in Cilicia in the 11<sup>th</sup> century BC) and Greece (present in the 7<sup>th</sup> century BC and in a widespread use from the 5<sup>th</sup> century BC). Confirmation for the earlier use of mortars, compared to Romans, can be found in Greek settlements, Etruscan tombs (reliefs, frescoes, but also as grave goods) and with Greek authors. The presence of mortars and the preparation of food connected to them can be further followed, from the time of Greek colonisation of Asia Minor while the Romans probably assumed them during the Greek colonisation of the Apennine Peninsula and the foundation of Greek colonies on the peninsula. The mortars on the European continent, as a ceramic shape, are connected to the Roman way of food preparation and their appearance is connected to the arrival of Romans on the area of the Central Europe and Britain. The use of mortars is very important and irreplaceable in the Roman cuisine (Baatz 1976–1977: 150, 154–155; Slapšak 1989: 16; Hargis 2007).

*Mortarium* (mortar) and *pistillum* (pestle) are mentioned together in written sources, in the context of their various uses. In Roman Antiquity, it appears that the mortar is mostly used in the preparation of food. Beside the written sources, there are portrayals of mortars on frescoes, vases, mosaics and stone monuments, in different contexts: in the household, in the burial and votive context. The pestle – *pistillum* is essential, since the mortar is useless without it (Slapšak 1989: 16; Ožanić 2004b: 9; Hargis 2007).

Mortars are one of the most widespread types of Roman ceramics. Early Empire mortars often have red or marbled decorations on the rim. The version without decorations appears in the 2<sup>nd</sup> and the 3<sup>rd</sup> century. In *Iovia* and *Jalžabet - Bartolovac*, there are glazed green mortars with a decoration on the rim (Jelinčić 2009: T. 44. 1; T. 52. 3). The rim of Pannonian mortars is decorated with a lot of glaze and coarse silt during the 4<sup>th</sup> century (Poczy 1957: 43). Earlier mortars are more massive than the later ones, while the newer ones are smaller in size and they have thinner walls. The first examples decorated with glaze appears during the 2<sup>nd</sup> and in the 3<sup>rd</sup> century (Kreković 1998: 24; Cool 2006: 44). In Britain, the earlier mortars differ from the newer ones not only in more massive walls, but also in a very rounded rim and lightly emphasised rib on the rim, while the newer ones have a very emphasised rib and a less expressed rim (Bédoyère 2000: 40).

The mass presence of glazed mortars in the Middle and the Lower Danube flow suggests their mass production in the 3<sup>rd</sup> and the 4<sup>th</sup> century, in the area of Pannonia. The local production of mortars also had to be present, because the examination of material showed that the analogue mortars

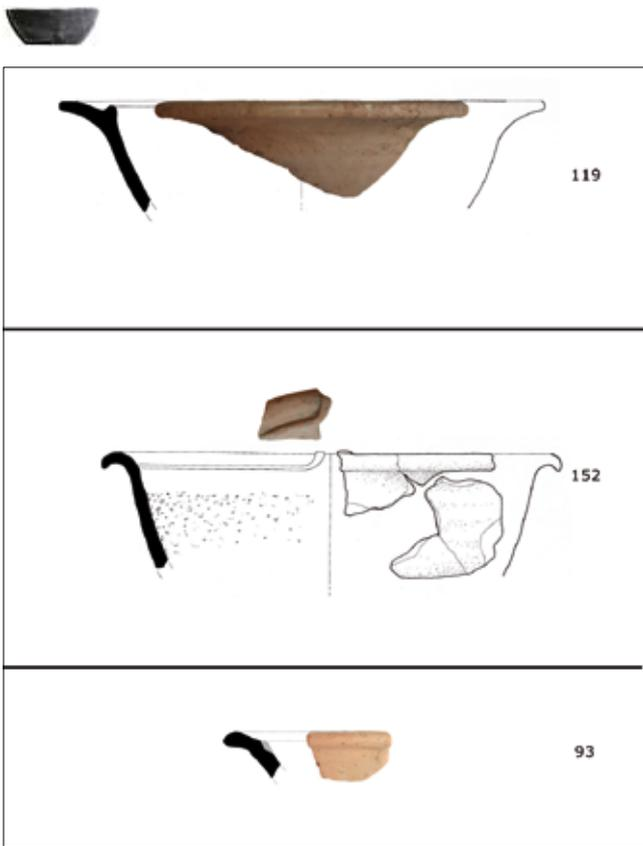

Sl. 161 Tarionici tip 1–3  
Fig. 161 Type 1–3 mortars

pljen na lokalitetu TÁC gdje se pretpostavlja i proizvodnja ovakvih i sličnih posuda (Thomas 1964: 321, T. CCVIII). Oblikom, u 2.–3- st. ovakvi tarionici javljaju se na lokalitetu Hrušica (*Ad Pirrum*), međutim na njihovom obodu nalaze se različiti urezani ukrasi i njihova unutrašnjost nije glazirana (Giesler 1981: 177, T. 37: 5–6; T. 56: 16, 19). U 3. i 4. stoljeću je na položaju rimske vile na lokalitetu TÁC-Fövenypusta djelovala keramičarska radionica u kojoj se proizvodila glazirana keramika. Na tom lokalitetu pronađen je i ovakav tip tarionika (Thomas 1955: 107, Abb. 3, 67, 122, 123, T. LI: 17). U blizini Savarije, u kasnoantičkom naselju datiranom u kraj 4. i 5. st. pronađen je sličan tarionik (Medgyes 2002: 116–117, T. I: 87, 450, 561), a iz istog razdoblja veliki je broj tarionika analogne profilacije na mađarskom lokalitetu Tokod (Bónis 1991: 94, 98, Abb. 1: 1, 7). Na zapadnom groblju Savarije, u grobu 10, također je zastupljen tarionik koji je sličan prvom tipu tarionika (Bíró 2004: 120).

Na lokalitetu Jalžabet tarionik ovakvog tipa, s mramoriziranim slikanjem na obodu i zelenom glazurom ispod rebra datira se u 3.–4. stoljeće (Vikić-Belančić 1968b: 92–94, T. IX: 2). U kasnu antiku datiraju se ovakvi tarionici i u Joviji (Vikić-Belančić 1983–1984, 157, T. 11: 11). Tarionici iz Jalžabeta i Jovije su drukčije strukture nego tarionici iz Virovitice Kiškorije jug. Tarionici ovakve profilacije pronađeni su na lokalitetu Jalžabet - Bartolovec (Jelinčić 2009: T. 44: 1–2), u Joviji (Jelinčić 2009: T. 52: 3; T. 53: 3) i Petrijancu (Jelinčić 2009: T. 60: 2). Oni se od tarionika iz Virovitice Kiškorije jug, ali i međusobno, razlikuju po strukturi, što

have a different fabric on individual sites (Jelinčić 2009: T. 44: 1–2; T. 52: 3; T. 53; T. 76: 1; T. 114: 1; sl. 54–59; 114–116). The production begins in Pannonia during the reign of Flavians and Traianus (*Poetovium*, *Aquincum*), while the mortars are manufactured in smaller local workshops in the 3<sup>rd</sup> and the 4<sup>th</sup> century (Baatz 1976–77; Brukner 1981: 38; Gabler 1982: 100). On the Danube Limes, in the area of Đerdap, the ceramics with glaze, including the mortars with glaze, appear in the last quarter of the 3<sup>rd</sup> century (Cvjetičanin 1995: 29). In *Poetovium*, the activity of the workshops and the mortars production were proven and the craftsmen which made them are known. These types of mortars appear in a large number along the Drava river and Danube river, and, beside in Pannonia, they are present in Moesia as well (Istenić 1999: 191–202; Cvjetičanin 2003: 99; 2006: 21). However these types are not represented on Virovitica Kiškorija south, according to the research done so far.

The mortars in this paper are divided into three types, according to the moulding of their rim. They are all made of ceramics with the same fabric and they have imprinted pebbles on the inner wall, over which there is a green glaze. The mortars with a similar shape as the mortars from Virovitica Kiškorija south, but with glaze, are present in provinces along the Middle and Lower Danube flow (compare mortars from Cvjetičanin 2003: 103; 2006: 26; Brukner 1981: T. 61). Skilled and specialised craftsmen were needed for the production of mortars (Cuomo di Caprio 1982: 213), and still, their different structure and shape indicate a production on a smaller area around Kiškorija, not a provincial production. The question, where exactly were some of the mortars produced, remains unanswered.

**Tr1** type (Pl. 15: 12). Cat. No. 119. This is a mortar with an outward drawn and lightly arched rim (fig.161). The rib is not highly emphasised and it transitions into the spout. There are no decorations or glaze on the rim, the slip is only present on the interior wall of the vessel, under the rib, above the imprinted pebbles. The glaze is olive-green. A similar mortar was found in *Siscia* (Katavić 2001: 37, T. 14: 11; Wiewegh 2001: 96, T. XI–XII) and in a gravel pit near Koprivnica (Marković 1993: 27–28). The mortar with a green glaze and whit this profilation was found in a layer, in the Early Empire necropolis of Kunovec Breg, where the graves date to the 1<sup>st</sup>–the 2<sup>nd</sup> century (Demo 1982: 292, T. 24: 14). This type is also present on TÁC site, where it is assumed that these and similar vessels were produced (Thomas 1964: 321, T. CCVIII). The mortars with this kind of shape are present on Hrušica site (*Ad Pirrum*) in the 2<sup>nd</sup> and the 3<sup>rd</sup> century, though their rim has various engraved decorations and their interior has no glaze (Giesler 1981: 177, T. 37: 5–6; T. 56: 16, 19). There was a ceramics workshop on the location of a Roman villa on TÁC-Fövenypust site, in the 2<sup>nd</sup>–the 3<sup>rd</sup> century, which produced ceramics with a glaze. This type of mortar was found on that site (Thomas 1955: 107, Abb. 3, 67, 122, 123, T. LI: 17). Near Savaria, a similar mortar was found in a Late Antiquity settlement that dates to the late 4<sup>th</sup> and the 5<sup>th</sup> century (Medgyes 2002: 116–117, T. I: 87, 450, 561), and numerous mortars were found, from the same period, on the Hungarian



upućuje na različite radionice u kojima su proizvedeni. Svi su glazirani u unutrašnjosti, a neki od njih na obodu imaju i ukras izveden mramorizacijom. Tarionici iz Jovije ovog tipa su manjih dimenzija od tarionika iz Virovitice Kiškorije jug. Što se tiče samog oblika, prema analogijama i <sup>14</sup>C analizama s Virovitice Kiškorije jug jasno je kako se Tr1 tip tarionika javlja od 1. pa do u 5. stoljeće. Ipak, temeljem ukrašavanja postoje neke kronološke odrednice (sl. 163). Od trećeg stoljeća tarionici su ukrašeni glazurom, a prije toga nerijetko mramoriziranjem.

Tip **Tr2** (T. 18: 3a–3b), kat. br. 152. Obod ovog tipa tarionika je lučno savijen, rebro je neznatno naglašeno te prelazi u izljev (sl. 161). Stijenke su neobično tanke za tarionik, obod nije ukrašen, a zeleno maslinasta glazura nalazi se ispod rebra u unutrašnjosti posude. Sličan oblik tarionika datiran u kasnu antiku susreće se i u Britaniji (Curle 1911: 263–265), zatim na lokalitetu Vinkovci – muzej gdje se datira od 3. do 4. st. (Ožanić 2004a: 139, T. 27: 8). U Dijani, Kostolcu i Ljubičevcu sreće se sličan oblik s nešto zaobljenijim obodom gdje se pojava ovakvog tarionika datira od posljednje četvrtine 3. do kraja treće četvrtine 4. stoljeća (Cvjetičanin 1995: 30), naglašeniji rub susreće se na Tekiji (Tomović 1984: 349, T. I: 1) na lokalitetu Tac gdje se datira u 3. st. (Bónis, 1980: 374–375). Prema analogijama i načinu ukrasa, ovaj tip tarionika datira se u 3. i 4. stoljeće (sl. 163).

Tip **Tr3** (T. 12: 1), kat. br. 93. Treći tip tarionika ima zanimljiv obod zbog toga što je on vrlo mali i nenaglašen, kao i njegovo rebro (sl. 161). Obod, kao i u prethodna dva tipa tarionika nema ukrasa, a zeleno maslinasta glazura iznad utisnutih kamenčića nalazi se tek ispod rebra na unutrašnjoj strani posude. Ovaj tip tarionika zastupljen je i u Bolenciju (Jelinčić 2009: kat. br. 156) a drukčije je strukture od tarionika iz Virovitice Kiškorije jug. Također je ovaj tip pronađen i u Sisciji (Jelinčić 2009: T. 114: 1), (Katavić 2001: 37, T. 14: 12), Sirmiju (Parović-Pešikan 1971: 35, XXI, 73, 10), a sličan se javlja i u ruralnom naselju na lokalitetu Závist u Češkoj (Motyková et al. 1991), te naselju iz 4. i početka 5. st. nedaleko od Savarie (Medgyes 2002: 116, 118, T. II: 56). U istom razdoblju prisutan je i u Tokodu (Bónis 1991: 94–95, Abb. 1: 14). Pronađen je i u Joviji (Jelinčić 2009: T. 53: 1–2).

Prema analogijama i analizama s Virovitice Kiškorije jug, ovaj tip tarionika datira se u 4. i 5. stoljeće (sl. 162).

Iako je tarionik posuda koja se svojom pojavom i ulogom u srednje europskim okvirima veže za rimsko carstvo, njegov oblik kroz stoljeća nije jednak u svim dijelovima Carstva, već se razlikuje od regije do regije. Tako se oblici koji su u ovom poglavlju navedeni susreću, osim na Virovitici Kiškoriji jug, u malom broju i to u sličnim varijantama u provinciji Panoniji i u njenoj bližjoj okolici, a nemaju nikakve sličnosti s oblicima koji se susreću dalje, počevši od Norika i Italije i dalje prema zapadu, osobito u Britaniji (uspoređi oblike tarionika u više zapadnih provincija u: Bédoyère 2000; Willems 2005). To vrijedi za tarionike kasne antike,

Tokod site Bónis 1991: 94, 98, Abb. 1: 1, 7). In the grave 10, in the western cemetery in Savaria, a mortar similar to the first type of mortars is present (Bíró 2004: 120).

On Jalžabet site, a mortar of this type with marbled painting on the rim and green glaze below the rib dates to 3<sup>rd</sup> - the 4<sup>th</sup> century (Vikić-Belančić 1968b: 92–94, T. IX: 2). Mortars from Jalžabet and Iovia have a different structure from the mortars from Virovitica Kiškorija south. Mortars with this profilation were found on Jalžabet-Bartolovec site (Jelinčić 2009: T. 44: 1–2), in Iovia (Jelinčić 2009: T. 52: 3; T. 53: 3) and Petrijanec (Jelinčić 2009: T. 60: 2). They differ from mortars from Virovitica Kiškorija south, and also among themselves, in fabric, which indicates that they were made in different workshops. They are all glazed on the inside, and some of them have a marbled decoration on the rim. This type of mortars from Iovia has smaller dimensions than mortars from Virovitica Kiškorija south. Concerning the shape, through analogies and <sup>14</sup>C analysis from Virovitica Kiškorija south, it is clear that Tr 1 type appears from the 1<sup>st</sup> to the 5<sup>th</sup> century. Nevertheless, their age can be chronologically determined based on the decoration (fig. 163). Mortars from the 3<sup>rd</sup> century are decorated with glaze while, before that time, they were often marbled.

**Tr2** type (Pl. 18: 3a–3b), Cat. No. 152. This type of mortars is arched and it has a slightly emphasised rib which transitions into a spout (fig. 161). The walls are uncommonly thin for a mortar, the rim has no decorations and they have an olive green glaze under the rib, on the inside of the vessel. A similar shape of mortars, that dates to the late Antiquity, is also present in Britain (Curle 1911: 263–265) as well as on the Vinkovci - muzej site, where it dates from the 3<sup>rd</sup> to the 4<sup>th</sup> century (Ožanić 2004a: 139, T.27: 8). There is a similar shape with a more rounded rim in Dijana, Kostolac and Ljubičevac, where these mortars appear from the last quarter of the 3<sup>rd</sup> to the third quarter of the 4<sup>th</sup> century (Cvjetičanin 1995: 30). The most emphasised edge can be found on Tekija (Tomović 1984: 349, T.I: 1), on Tac site, where it dates to the 3<sup>rd</sup> century (Bónis, 1980: 374–375). According to the analogies and the decoration style, this type of mortars dates to the 3<sup>rd</sup> and the 4<sup>th</sup> century (fig. 163).

**Tr3** type (Pl. 12: 1), Cat. No. 98. The third type of mortars has an interesting rim, as it is very small and not emphasised, just like its rib (fig.161). Same as with the other two types of mortars, the rim has no decorations and the olive green glaze over the imprinted pebbles is situated only below the ribs on the inner wall of the vessel. This type of mortars is present in *Bolentium* (Jelinčić 2009: kat. br. 156), but it has a different fabric from the mortars from Virovitica Kiškorija south. It was also found in *Siscia* (Jelinčić 2009: T. 114: 1), (Katavić 2001: 37, T. 14: 12) and *Sirmium* (Parović-Pešikan 1971: 35, XXI, 73, 10). A similar type appears in a rural settlement on Závist site in Czech Republic (Motyková et al. 1991) and in a settlement close to Savaria, from the 4<sup>th</sup> and the early 5<sup>th</sup> century (Medgyes 2002: 116, 118, T. II: 56). It is present in Tokod in the same time period (Bónis 1991: 94–95, Abb. 1: 14) and it was found in Iovia as well (Jelinčić 2009: T. 53: 1–2).



TIP POSUDE	1. st.	2. st.	3. st.	4. st.	5. st.
Tr 1			—————		
Tr 2			—————		
Tr 3				—————	

Sl. 162 Tipološko-kronološka tabela tarionika  
 Fig. 162 Typological and chronological table of mortars

budući da su gore opisana tri tipa datirana u kasnu antiku. Broj analogija ovih tarionika u Sisciji, posebno Tipa Tr1 je upečatljiv. Za određivanje porijekla tarionika treba uzeti u obzir i lokalitet TÁC-Fövenypusta gdje je pronađena radionica glazirane kasnoantičke keramike tip Tr1. Pored tog tipa, na ovom lokalitetu pronađeni su i tipovi zdjela kakvi postoje na Virovitici Kiškoriji jug, Z3. Ipak, međusobna različitost strukture tarionika iz Virovitice Kiškorije jug i Bolencija te različitost u odnosu na one analogne tarionike u Sisciji, Joviji i Jalžabet-Bartolovcu više govori u prilog njihovoj lokalnoj proizvodnji.

### 3.3.6. Posude za čuvanje hrane i druge vrste posuđa

U ovoj kategoriji donose se posude koje čine pojedinačne nalaze, a koje su vrlo zanimljive te svakako zaslužuju da ih se predstavi. Drugi razlog je i taj što su izrađene od lokalne strukture.

Posude – doliji (T. 3:1; T. 26: 1), (kat. br. 24, 218) su služile za čuvanje namirnica (sl. 163). Nalikuju loncima s Virovitice Kiškorije jug (tip L3). Imaju širok i koso izvijen te nešto zadebljan obod, zaobljeno rame i vrlo široko tijelo. Posude velikih dimenzija za čuvanje hrane nazivaju se doliji, međutim oni su često drugačije izrade i oblikovanja. Posude s Virovitice Kiškorije jug su izrađene od iste strukture kao i većina posuda na Virovitici Kiškoriji jug (VKJ 2), ali je bolje pečena. S obzirom na strukturu, dimenzije i oblik, za pretpostaviti je da se tu radi o lokalnoj varijanti velike posude za spremanje hrane. S obzirom da na vanjskoj stijenci ima premaz, u njoj su se mogle čuvati i namirnice tekućeg sadržaja. Oblikom podsjeća na lonac tip L3 koji se datira od 2. do kraja 4. stoljeća, moguće je da se ovako datira i ova posuda.

Velike posude za čuvanje hrane česte su i široko su rasprostranjene, tako i u jugozapadnoj Panoniji, te se većim dijelom mogu smatrati proizvodima lokalnih radionica (Vikić-Belančić 1965: 109), a u slučaju Virovitice Kiškorije jug, vjerojatno majstora iz samoga sela.

In accordance with analogies and analysis from Virovitica Kiškorija south, this type dates to the 4<sup>th</sup> and 5<sup>th</sup> century (fig. 162).

Although the mortar is a vessel, which is tied to the Roman Empire in frameworks for Central Europe, with its phenomenon and role, its shape varies through centuries in all parts of the Empire, and it is different from one region to another. Types mentioned in this chapter are present, besides on Virovitica Kiškorija south, in a small number and similar versions in the province of Pannonia and its near surroundings. They do not have any similarities with shapes found in distant areas, starting from Noricum and Italy and further west, especially in Britain (compare the mortar shapes from several west provinces in: Bédoyère 2000; Willems 2005). This also applies to the mortars from the late Antiquity, since the three types described above date to the late Antiquity. There is an impressive number of analogies for these mortars in Siscia, especially for the Tr1 Type. TÁC-Fövenypust site, where the workshop for the late Antique ceramics with glaze, Tr1 type, was found, should be taken into account to determine the origin of mortars. Apart from that type, types of bowls Z3, like the ones from Virovitica Kiškorija south, were also found on this site. Still, the difference in fabric between mortars from Virovitica Kiškorija south and Bolentium and the difference from the analogue mortars in Siscia, Iovia and Jalžabet-Bartolovac indicates their local production.

### 3.3.6. Vessels used for food storage and other types of dishes

Individual finds, which are very interesting and deserve to be studied, will be presented in this category. Another reason is the fact that they were made from local fabric.

*Dolia* – (Pl. 3:1; Pl. 26: 1), (Cat. Nos. 24, 218) vessels used for food storage (fig. 163). They resemble the pots from Virovitica Kiškorija south (L3 type). Their slightly thickened rim is wide and obliquely curved, the shoulder is thickened and their body is very broad. Vessels of large dimensions used for food storage are called *dolia*, though they are often differently produced and moulded. Vessels from Virovitica Kiškorija south have the same fabric as most of



Sl. 163 Doliji, tava i amfore (?)

Fig. 163 Dolia, pan and amphorae (?)

Predmet pod kat. br. 130 (T. 16: 9) ima cilindričan oblik i dvije pravilno oblikovane rupe, postavljene jedna nasuprot druge (sl. 163). Radi se o cilindričnom grlu velike posude za čuvanje hrane, nalik kat. br. 131, koja je imala dvije drške koje su bile pričvršćene na samo vrat sa svojim gornjim dijelom. Prilikom izrade same posude, bile su načinjene dvije pravilne rupe, jedna nasuprot druge, u koje su umetnute i pričvršćene drške. Drške su na kraju otpale što je vidljivo iz oštećenja kružnog oblika oko samih rupa na vanjskoj stijenci grla. Posuda je vjerojatno tada, prilikom oštećenja prenamijenjena na način da je uklonjen njezin donji dio, niže od ramena, dorađen kako ne bi bio oštar, a preostalo cilindrično grlo moglo je služiti kao prijenosno ognjište. Kao što je i objavljivano u kontekstu keramičkih prijenosnih ognjišta, ona se javljaju zajedno s velikim tavama na koje se naslanjaju i loncima koji se naslanjaju na samo keramičko ognjište. U ognjištima i na tavi nalazi se gar, te se na taj način hrana u loncu priprema ili održava toplom. Ta prijenosna ognjišta mogu biti u obliku polucilindra, te u tom slučaju imaju dugmad na obodu kako bi lonac na ognjištu bio stabilan. Pronađena ognjišta imaju i rupe sa strane, a za to su u ovom slučaju poslužile rupe otpalih drški, a uloga tih rupa je ta da služe za dovod zraka kako bi se žar održao. Polucilindrična ognjišta pronađena su na Agori u Ateni, ali i kod nas na Jadranu na brodskom teretu namijenjenom daljnjoj prodaji na lokalitetu Pod galiju (Viganj) te se datiraju u 1. i u 2. stoljeće po. Kr. Robinson navodi kako se kasnije takva ognjišta više ne koriste te da su u upotrebi metalna ognjišta (Robinson 1959: 34–35, T. 38; Rapanić 1972: 144; Jurišić 2000: 36–37, fig. 34; Fisković 2001: 57, sl. 5). Kako se ovdje radi o cilindričnom predmetu, nema potrebe za dugmetima za pričvršćivanje lonca, jer je samim njegovim oblikom posuda na njemu stabilna. Predmet je također bio stabilan jer je slomljeni prijelaz vrata posude u rame dorađen i zaobljen. Svojim cilindričnim

the vessels on Virovitica Kiškorija south (VKJ 2), but they are fired better. Considering the fabric, size and shape, it can be assumed that this is a local version of a big vessel for the food storage. Given that there is a slip on the outside wall, liquid groceries might have been stored in it. Its shape resembles the L3 type pot, which dates from the 2<sup>nd</sup> to the late 4<sup>th</sup> century, so it is possible that this vessel dates to the same period.

Large vessels used for food storage are frequent and widely spread, including in the Southwest Pannonia. They may mostly be considered to be a product of the local workshops (Vikić-Belančić 1965: 109) and in the case of Virovitica Kiškorija south, they were probably manufactured by a craftsman from that village.

The Cat. No. 130 (Pl. 16: 9) has a cylinder shape and two regularly moulded holes, placed right across from each other (fig. 163). It is a cylinder neck of a large vessel for food storage, similar to the Cat No. 131, which had two handles attached with their upper part to the neck itself. Two regular holes were made across from each other, during the production of the vessel, in which the handles were inserted and attached. The handles fell off, which is apparent from the roundly shaped damage around the holes on the outside wall of the neck. The vessel was probably, when it was damaged, repurposed, in a way that the part below the shoulders was removed and remade, not to be sharp, while the other part of the cylinder neck may have served as a portable hearth. Just like the published works about the portable ceramic hearths describe, they appear together with large pans, on which they lean on and with pots which lean on the ceramic hearth itself. The food is prepared in the pot and kept warm in a way that soot is put in the hearth and in the pan. These portable hearths can be made in a shape of a half cylinder and in that case they have buttons on the rim, so that the pot would be stable on the hearth. Found hearths also have holes on their side walls, although in this case those holes are left



oblikom ovakvo je ognjište i praktičnije budući da se na njega mogu nasloniti posude različitog promjera, dok dugmad na polucilindričnim prijenosnim ognjištima ipak ima određena ograničenja, tj. na polucilindrično ognjište stane posuda određenog promjera. Za podsjetiti se je i da brodsko ognjište (fogun) također ima cilindričan oblik (nešto više) i ima rupice za zrak, kao druga varijanta prijenosnog ognjišta (Vrsalović 1974: 141, sl. 166; Jurišić 2000: 36, fig. 28).

Postoje brojni drugi primjeri sekundarne upotrebe keramike i njenih dijelova. Primjer recikliranja grla amfore u svrhu prijenosnog ognjišta u kojemu je pronađen i pepo poznat je iz Pompeja (Peña 2007: 120, 149–150), a ovaj primjer najviše podsjeća na predmet s Virovitice Kiškorije jug. O tipovima prijenosnih ognjišta piše i Kapitän (Kapitän 1980).

Prijenosna keramička ognjišta bila su korištena ne samo na brodovima već i u gradovima i česta su pojava u rimskim kuhinjama (Slapšak 1989: 15). Problem je što nisu prepoznata među keramičkom građom. Prednost prijenosnih ognjišta je u tome što za pripremu hrane troše manje goriva (Cool 2006: 52).

Posuda je nalik amfori ili velikom vrču s dvije drške (T. 16: 10), (kat. br. 131), a služila je za čuvanje namirnica (sl. 163). Ona ima široki vrat s prstenasto zadebljanim rubom koji na svom prstenastom zadebljanju ima vodoravno urezanu liniju. Na vratu su se nalazile dvije drške, jedna nasuprot drugoj. Vrat prelazi u široko rame, ima ravno dno na prstenastoj, zaobljenoj nozi. Posuda je lokalne proizvodnje, kao i većina posuda na Virovitici Kiškoriji jug. Zbog toga, ona nije kvalitetna i pogodna za transport, te je vjerojatno služila za skladištenje hrane, ali i pića, budući da su joj unutarnja i vanjska stijenka premazane. Zastupljenost vrčeva s ovakvim, širokim vratom te trakasto ili prstenasto oblikovanim obodom i trbušastim tijelom na prostoru jugozapadnog dijela provincije Panonije uočava i B. Vikić-Belančić i to u Sisciji i Petoviju (Vikić-Belančić 1965: 105, sl. 40, 8, 17, 107).

Predmeti pod kat. br. 130–131 iz Virovitice Kiškorije jug pronađeni su u zatvorenoj arheološkoj cjelini, u bunaru koji je datiran <sup>14</sup>C datumom od sredine 2. do sredine 3. st. po. Kr. koji se po glaziranoj kasnoantičkoj keramici i staklenoj narukvici datira uže, u prvu polovicu 3. st. Struktura predmeta je ista kao i struktura većine grube keramike s Virovitice Kiškorije jug (VKJ 2).

Niska posuda (T. 4: 14a–b), (kat. br. 38) širokog, blago izvijenog oboda s jednom drškom ovalnog presjeka (sl. 163). Bočne stijenke su kose, drška je puna, nije šuplja kao što je slučaj kod drški kod slične posude kao što je *casseroles*. Tava je izrađena od strukture keramike kao i većina posuda s Virovitice Kiškorije jug (struktura VKJ 2). Riječ je o tavi korištenoj za pripremu hrane, a ima premaz na unutrašnjoj strani te je mogla držati tekućinu. Apicije u

from the handles that fell off. Their role was to allow the air-flow to keep the flame alive. The half cylinder hearths were found on Agora in Athens, but also in the Adriatic Sea in Croatia on Pod Galiju site (Viganj), among the ships' cargo that was intended for further resale, and they date to the 1<sup>st</sup> and the 2<sup>nd</sup> century. Robinson states that these hearths were not in use later and that they were replaced by the metal ones (Robinson 1959: 34–35, T.38; Rapanić 1972: 144; Jurišić 2000: 36–37, fig. 34; Fisković 2001: 57, sl. 5). Since this is a cylinder object, there is no need for the buttons used to attach the pot, because the shape allows the vessel to be stable. The object was stable as well due to the broken transition of the neck into the shoulder, which was remade and rounded. The cylinder shape makes this hearth more practical, since it is possible to lean vessels of different diameter on it, while the buttons on the half cylinder hearths have certain limitations, i.e. only vessels of certain diameter can fit the half cylinder hearth. We need to be reminded that the ship's hearth (fogun) has a cylinder shape (a little bit more), too, and it has holes for air, like the second variant of the portable hearth (Vrsalović 1974: 141, sl. 166; Jurišić 2000: 36, fig. 28).

There are numerous other examples of the functional ceramics and its pieces. There is an example of amphora's recycled throat, from Pompeii, used as a portable hearth, in which ashes were found (Peña 2007: 120, 149–150). This example resembles an object from Virovitica Kiškorija south the most. Kapitän also writes about the types of portable hearths (Kapitän 1980).

The portable hearths were not only used on ships, but also in towns, and they are common in Roman kitchens (Slapšak 1989: 15). The problem is that they were not recognised among the ceramic material. The advantage of portable hearths is that they need less fuel for the preparation of food (Cool 2006: 52).

The vessel is similar to an amphora or a big jug with two handles (Pl. 16: 10), (Cat. No. 131) and it was used for food storage (fig. 163). It has a wide neck with a ring-shaped thickened edge, which has an imprinted horizontal line on its ring-shaped thickening. There were two handles on the neck, opposite to each other. The neck transitions into a broad shoulder, it has a flat base on a ring-shaped and rounded foot. The vessel is locally produced, like most of the vessels on Virovitica Kiškorija south. Consequently, its quality is low and it is unsuitable for transport. It was probably used for food and drinks storage, since the interior and exterior walls have a slip. B. Vikić-Belančić also notices the presence of jugs with a wide neck, a striped or ring-shaped rim and a paunchy body, in the area of the southwest part of the Pannonia province, in *Siscia* and *Petovium* (Vikić-Belančić 1965: 105, sl. 40, 8, 17, 107).

Items Cat. Nos. 130–131, from Virovitica Kiškorija south, were found in an enclosed archaeological whole, in a well that, based on <sup>14</sup>C analysis, dates from the mid-2<sup>nd</sup> to the mid-3<sup>rd</sup> century. This well can be more precisely dated to the first half of the 3<sup>rd</sup> century, because of the late Antique glazed ceramics and a glass bracelet. These items have the same fabric as most of the coarse ceramics from Virovitica Kiškorija south (VKJ 2).



svojim receptima često spominje tave za pripremu, ali i serviranje hrane i to kao *patella* i *patina*. *Patina* je naziv, ne samo za posudu, nego i za veliki broj jela koja su svoje ime vjerojatno dobila po toj posudi (Apicije IV, 2. 1–37, Slapšak 1989: 61–67, 175). Recepti koji se spominju uglavnom podrazumijevaju pripremu jela od pečenog mesa, ribe i juhe. Mogla je služiti za sušenje žitarica, a jedan od načina pripreme bio je da se posuda stavi u vruću pepeo. Tave su često nalaz na Mediteranu gdje su velikih dimenzija. Tave kao što je ova, zbog fragmentiranosti grube keramike vjerojatno nisu prepoznate, a s obzirom na broj recepata koji postoji, moralo ih je biti mnogo. Oblikom slična *patera* se u izvorima najčešće spominje u kontekstu prinošenja žrtava, a vrlo rijetko u kućanstvu. Radi se o niskim i široko otvorenim posudama koje imaju dršku, ukrašene su reljefno, a služile su u obredne svrhe za prinošenje žrtava (krv, vino). Nazivaju se *patera* ili ako su dublje *casserola*. S obzirom da je tava s Virovitice Kiškorije jug služila za pripremu hrane, što je glavno obilježje posude koju izvori nazivaju *patina*, tava s Virovitice Kiškorije jug bila bi *patina*, a ne *patera*. One su bile izrađivane od metala, stakla, ali i od keramike kao što je slučaj s tavom s Virovitice Kiškorije jug (Hilgers 1969: 71–73, 242–247; Matthews 1969: 33–34; Vrsalović 1974: 141, sl. 165, 182; Istenič, Schneider 2000: 341, 345, Fig. 5: 4; Jurišić 2000: 36, fig. 27, 35–36). Pojava keramičkih tava, kao i drugih vrlo karakterističnih varijanata uvijek se može očekivati, posebno u malim sredinama s lokalnom proizvodnjom. Tako je na paljevinskom groblju iz 1. st. po. Kr. Volarije pri Žirjah u Sloveniji pronađena keramička tava lokalno proizvedena s malom drškom (Bavdek 2005: 246, 258, G 14 T. 6: 5). Ova posuda izrađena je od strukture keramike kao i većina keramičkih predmeta s Virovitice Kiškorije jug (VKJ 2). Tava s Virovitice Kiškorije jug nema ukrasa te je vrlo jednostavna, kao i sva druga uporabna keramika s ovog lokaliteta. Zbog svoje jednostavnosti sigurno je da je ona služila u domaćinstvu, a ne u obredne svrhe. Posuda je pronađena u objektu koji je datiran <sup>14</sup>C analizom ugljena u 2. polovinu 2. st. po. Kr.

A short vessel (Pl. 4: 14a–b), (Cat. No. 38) with a wide and slightly curved rim and one handle with an oval cross section (fig. 163). The lateral walls are oblique, the handle is full and not hollow like the handles of similar vessels like *casserola*. The pan is made from a ceramic structure, like most of the vessels from Virovitica Kiškorija south (structure VKJ 2). This pan was used for food preparation, it has a slip on the inside and it could hold liquids. Apicius often mentions in his recipes pans for the food preparation, but also for the serving of food, like *patella* and *patina*. *Patina* is a name, not only for a vessel, but also for a large number of dishes, which were probably named after that vessel (Apicije IV, 2. 1–37, Slapšak 1989: 61–67, 175). The mentioned recipes are mainly for the preparation of roasted meat, fish and soup. It could also serve for drying of cereals – putting of the vessel in the hot ashes was one of the ways of preparing them. The pans are a frequent find on the Mediterranean, where they are large sized. There must have been many pans like this one, because of numerous recipes, but they were probably not recognised, as a result of the coarse ceramic's fragmentation. The *patera*, which has a similar shape, is mostly mentioned in the context of sacrifice and very rarely in the household. They are short and wide open vessels with a handle and a relief decoration, which were used for ceremonial purposes, for sacrifice (blood, wine). They are called *patera* or, if they are deeper, *casserola*. Given that the pan from Virovitica Kiškorija south was used for food preparation, which is the main feature of the vessels called *patina*, the pan from Virovitica Kiškorija south is a *patina* and not a *patera*. They were made of metal, glass, but also of ceramics, like the pan from Virovitica Kiškorija south (Hilgers 1969: 71–73, 242–247; Matthews 1969: 33–34; Vrsalović 1974: 141, sl. 165, 182; Istenič, Schneider 2000: 341, 345, Fig. 5: 4; Jurišić 2000: 36, fig. 27, 35–36). The appearance of ceramic pans, as well as the other characteristic versions, can always be expected, especially in small communities with a local production. A locally produced ceramic pan with a small handle was found in the incineration cemetery from the 1<sup>st</sup> century, in Volarije pri Žirjah, Slovenia (Bavdek 2005: 246, 258, G 14 T. 6: 5). This vessel is made from ceramic fabric, like most of the ceramic objects from Virovitica Kiškorija south (VKJ 2). The pan from Virovitica Kiškorija south is very simple, with no decoration, like any other functional ceramics from this site. Because of its simplicity, it must have been used in a household and not for ceremonial purposes. The vessel was found in a structure which, according to <sup>14</sup>C analysis, dates to the second half of the 2<sup>nd</sup> century.



TIP POSUDE	1. st.	2. st.	3. st.	4. st.	5. st.
 Tava					
 Amfora ?					
 Amfora ?					
 Dolij					

Sl. 164 Tipološko-kronološka tabela  
Fig. 164 Typological and chronological table

## 3.4.

### Stolno posuđe i posuđe dvostruke funkcije *Tableware and dual function dishes*

#### **Stolno posuđe**

Na Kiškoriji je pronađena izuzetno mala količina ove vrste posuđa i riječ je o vrlo malim ulomcima.

#### **Tera sigilata**

Tera sigilata je stolno posuđe koje se uvozilo i na ovom je lokalitetu prava rijetkost. Od sveukupne keramičke građe pronađeno je svega 5 ulomaka (T. 1: 3; T. 17: 8; T. 20: 6; T. 25: 2; T. 28: 6). Neki se ulomci ne mogu tipološki odrediti (T. 1: 3; T. 25: 2; T. 28: 6), a dva ulomka koji mogu pripadaju zdjelama Drag. 32 (T. 17: 8; T. 20: 6) i datiraju se od 160. do 230. po. Kr. Svi su ulomci vjerojatno izrađeni u Rheinzaubernu. Proizvodi te radionice, uključujući i zdjele Drag. 32 susreću se u velikom broju u Panoniji (Vikić-Belančić 1965: 94; Makjanić 1990: 32; 1996: 98; Brukner 1981: 21; Wiewegh 2001: 101).

#### **Keramika tankih stijenki**

Čaša keramike tankih stijenki ima rijetke analogije (T. 18: 9). Najsličniji predmet pronađen je u Ščitarjevu (Nemeth-Ehrlich 1994: 121–122). Takva čaša podsjeća na čaše izrađene od stakla Isings 25 koje su se izrađivale krajem 1. i početkom 2. st. a pronađene su u Celju (Lazar 2004: 33–34). Još sličnija staklena čaša pronađena je na lokalitetu *Vetus Salina* i datirana je u drugu polovinu 1. st. (Barkóczy 1988: 103, T. XV: 161) Time bi dataciju ovog predmeta mogli smjestiti u prvu polovinu 2. st. Od iste keramičke strukture izrađen je i ulomak čaše ili šalice kat. br. 207 (T. 23: 6).

#### **Posuđe s dvostrukom funkcijom**

Keramičko posuđe koje je moglo služiti kao stolno posuđe i ujedno se upotrebljavati u pripremi hrane. Riječ je o različitim tipovima posuđa panonske proizvodnje pečenim različitim tehnikama.

#### **Panonska sivo pečena keramika**

U južnoj Panoniji čest je nalaz keramičko posuđe sivo pečene boje. Tu se misli na posuđe koje može imati vrlo tanak mat premaz i tada je najčešće riječ o vrčevima i loncima oblikovanima u skladu s latenskim tradicijama. Također tu mislimo i na posude s gustim premazom metalnog sjaja, često praćenim pečatnim ukrasom ili ukrasom izvede-

#### **Table ware**

On Kiškorija, an extremely small quantity of this type of dishes was found and they are in extremely fragmented.

#### **Terra sigillata**

*Terra sigillata* is a table ware that was imported and it is quite rare on this site. Only five fragments were found among the entire ceramic material (Pl. 1: 3; Pl. 17: 8; Pl. 20: 6; Pl. 25: 2; Pl. 28: 6). Some fragments cannot be typologically defined (Pl. 1: 3; Pl. 25: 2; Pl. 28: 6); two fragments that can, belong to Drag. 32 bowls (Pl. 17: 8; Pl. 20: 6) and date from the year 160 to the year 230. All the fragments are from Rheinzaubern workshops. Numerous products from that workshop, including the Drag. 32 bowls, are present in Pannonia (Vikić-Belančić 1965: 94; Makjanić 1990: 32; 1996: 98; Brukner 1981: 21; Wiewegh 2001: 101).

#### **Thin walled ceramics**

The ceramic cup with thin walls has very few analogies (Pl. 18: 9). The most similar object was found in Ščitarjevo (Nemeth-Ehrlich 1994: 121–122). This cup resembles cups made from Isings 25 glass, which were produced in the late 1<sup>st</sup> and the early 2<sup>nd</sup> century found in Celje (Lazar 2004: 33–34). An even more similar glass cup was found on *Vetus Salina* site and dates to the second half of the 1<sup>st</sup> century (Barkóczy 1988: 103, T. XV: 161). Thereby, we may date this object to the first half of the 2<sup>nd</sup> century. The fragment of a cup or a mug Cat. No. 207 (Pl. 23: 6) has the same ceramic fabric.

#### **Dual function dishes**

Ceramic dishes that may have served as tableware and at the same time for the preparation of food. It concerns different types of dishes, that were produced using various firing techniques in Pannonia.

#### **Pannonian grey fired ceramics**

Grey fired ceramic dishes are a frequent find in the South Pannonia. This refers to dishes which can have a very thin matte slip. Those are mostly jugs and pots, moulded according to the La Tène traditions, as well as the dishes with a thick metal glossy slip, often accompanied by a seal decoration or a rouletting decoration. Bowls and plates



nim kotačićem. Tako su najčešće ukrašavane zdjele i tanjuri (Brukner 1981; Gregl 1989; 1997; Ožanić 2004a; Gregl, Jelinčić 2010).

#### *Panonska sivo pečena keramika sa sjajnim premazom*

Na lokalitetu Virovitica Kiškorija jug, pronađeni su ulomci dvije zdjele. Ulomak prve zdjele (T. 18: 11) pripadao je loptasto oblikovanoj zdjeli koje su u Panoniji izrađivane u oksidacijskoj i redukcijskoj varijanti. U Gornjoj Panoniji na velikom broju lokaliteta one su crno do sivo pečene boje s različitim pečatnim ukrasima i ukrasima izvedenim kotačićem (Gregl 1997). Druga zdjela (T. 24: 4) također je vrlo zastupljen tip u Panoniji s analogijama iz Maksimira i Slovenije datiranima u 1. i 2. st. (Gregl, Jelinčić 2010: 160).

#### *Panonska sivo pečena keramika s premazom*

Riječ je o vrlo rasprostranjenoj, često proizvedenoj i korištenoj vrsti posuđa. Premaz na ovim posudama (vrčevima i loncima) je mat ili slabog sjaja, tanak je i ponekad jako oguljen. Tanak premaz osiguravao je nepropusnost posude. Oblici vrčeva i lonaca izrađivanih na ovaj način baštine nasljeđe latenskog posuđa u oblikovanju i tehnologiji. U većoj su mjeri prisutni u prva dva stoljeća, ali se javljaju i kasnije (Brukner 1981: 44; Ožanić 1998: T. 17). U drugu polovicu 1. st. datirani su na Liskovcu (Ožanić Roguljić 2009: 93–94). Velika količina tog posuđa nesumnjivo upućuje na velik broj proizvodnih centara, manjih i većih te im do sada na prostoru hrvatskog dijela Panonije nije posvećena pažnja. Obradom keramičkog materijala na jednom lokalitetu, a naročito na više njih, uočava se mnoštvo različitosti u strukturama od kojih je izrađivano ovo posuđe. Neke od struktura na Kiškoriji javljaju se samo na primjeru jednog ulomka te se nisu zasebno obrađivale. Bez ciljanog istraživanja ove vrste posuđa, nije moguće utvrditi proizvodne centre i pripisati im strukture. Zbog toga je teško definirati je li riječ o keramici koja je proizvedena u blizini Kiškorije ili je na lokalitet došla trgovinom s manje ili više udaljenih krajeva. Fragmentiranost posuđa s Kiškorije ne dozvoljava detaljniji tipološki pristup: može se samo zaključiti da je riječ o loncima ili još češće vrčevima s jednom ručkom koje nadvisuju obod, a izrađene su od različite strukture, nepoznate panonske proizvodnje (T. 2: 12; T. 5: 7–8; T. 12: 6–7; T. 14: 8; T. 15: 13; T. 17: 9–17; T. 20: 8; T. 21: 8; T. 28: 11).

### **Crveno pečena keramika**

#### *Bez slikanja*

U Panoniji se tijekom 1. st. javljaju amfore ravnog dna (Brukner 1981: T. 165–166). Na Kiškoriji su pronađeni ulomci tri drške koje bi mogle pripadati takvim amforama, naročito kat. br. 97 (T. 12: 5). Takve su amfore česte u Panoniji, a često ih nazivaju i vrčevima radi njihovih manjih dimenzija i ravnog dna (Wiewegh 2001: 97–98; Bačani et al. 2011: 136–137). Riječ je o amforama koje se javljaju u Gornjoj Panoniji, Noriku, Reciji i izrađivane su u 1. st., a proizvodnja im prestaje razvojem trgovine i učvršćivanjem

are usually decorated in that manner (Brukner 1981; Gregl 1989; 1997; Ožanić 2004a; Gregl, Jelinčić 2010).

#### *Grey fired Pannonian ceramics with a glossy slip*

Fragments of two bowls were found on Virovitica Kiškorija south site. The fragment of the first bowl (Pl. 18: 11) belonged to a spheroid bowl, the kind which was produced in an oxidative or a reductive version, in Pannonia. On numerous sites in Pannonia, their firing colour varies from grey to black with different seal and rouletting decorations (Gregl 1997). The second bowl (Pl. 24: 4) is also a very frequent type in Pannonia, with analogies from Maksimir and Slovenia dated to the 1<sup>st</sup> and the 2<sup>nd</sup> century (Gregl, Jelinčić 2010: 160).

#### *Grey fired Pannonian ceramics with a slip*

This type of dishes was widespread, often produced and used. The slip on these vessels (jugs and pots) is matte or very low-gloss, it is thin and sometimes mostly peeled. The thin slip secured the vessel's impermeability. The shapes of the jugs and pots, made this way, were modelled after the La Tène traditions in moulding and technology. They are largely present in the first two centuries, but they also appear later (Brukner 1981: 44; Ožanić 1998: T. 17). They are dated on Liskovac to the 1<sup>st</sup> century (Ožanić Roguljić 2009: 93–94). The large quantity of these dishes undoubtedly points that there were numerous smaller or larger production centres. Until now, there was no attention dedicated to them on the Croatian part of Pannonia. By processing the material on one site, and especially on several sites, we can notice a lot of diversities in the fabric, of which these dishes were made. Without a targeted research of this kind of dishes it is not possible to determine the production centres and their fabric. Consequently, it is hard to define if these ceramics were produced in the surroundings of Kiškorija or if they were commercially imported from more or less distant areas. The fragmentation of the dishes from Kiškorija does not allow a more typological approach: it can be concluded that it regards the pots or more often jugs with one handle, that overhangs the rim, and that they have a different fabric, unknown to the Pannonian production (Pl. 2: 12; Pl. 5: 7–8; Pl. 12: 6–7; Pl. 14: 8; Pl. 15: 13; Pl. 17: 9–17; Pl. 20: 8; Pl. 21: 8; Pl. 28: 11).

### **Red fired ceramics**

#### *Without painting*

The amphorae with a flat base appear in Pannonia in the 1<sup>st</sup> century (Brukner 1981: T. 165–166). The fragments of three handles, that may be a part of these amphorae, were found on Kiškorija; particularly Cat. No. 97 (Pl. 12: 5). This type of amphora is frequent in Pannonia and they are often called jugs, due to their small size and flat base (Wiewegh 2001: 97–98; Bačani et al. 2011: 136–137). These amphorae are present in the Upper Pannonia, *Noricum* and *Raetia* and were produced in the 1<sup>st</sup> century. The growth of the commerce and the strengthening of the trade network, by which wine and oil were imported to this area from Italy, Spain (Brukner 1981: 45) and Istria, stopped



trgovačke mreže kojom u taj prostor stižu vina i ulja iz Italije, Španjolske (Brukner 1981: 45) i Istre. Drugi su ulomci sitniji i mogli bi pripadati i vrčevima (T. 15: 14; T. 21: 9).

Manjem loncu ili vrču pripadao je ulomak kat. br. 139 (T. 17: 7), kojeg nije moguće pobliže tipološki i kronološki odrediti. Pored tog ulomka pronađeni su i ulomci zdjela (T. 24: 5; T. 28: 5). Kat. br. 214 nalikuje na kasnoantičke zdjele vodoravnog oboda, kakve se javljaju u 3. i 4. st. ali su glazirane.

#### *Sa slikanjem*

Pronađeno je više ulomaka ramena, trbuha ili dna posuda koje su pripadale vrčevima ili loncima, a imale su gusti crveni premaz (T. 5: 9; T. 9: 12; T. 18: 8). Ti su ulomci različitih i nedefiniranih struktura, te nesumnjivo predstavljaju uvoznju keramiku na lokalitetu.

Pronađeni su ulomci dvije zdjele (T. 14: 1; T. 17: 4) koji imitiraju sigilatni oblik Drag. 37. Sigilata tog oblika prisutna je u velikom broju u Panoniji (Brukner 1981: 21; Ožanić 1998: T. 1). Zdjela kat. br. 181 imitira sigilatni oblik Drag. 32 (T. 20: 15), datiran u drugu polovicu 2. i 3. st. ali se javlja i ranije kao oblik naslijeđen iz latenskog razdoblja. Nisu izoliran nalaz i ima ih na više lokaliteta u Panoniji (Ožanić Roguljić 2009: 84).

Na lokalitetu su pronađene samo dvije čaše. Jedna je kat. br. 126 (T. 16: 5), a riječ je o čaši s naborima (*Faltenbecher*), crveno pečene boje sjajnog i gustog crvenog premaza iz 2. st. Proizvodnja ovog tipa zabilježena je u Ptuj (Istenić 1999: 117–118). Druga je čaša izrađena u tehnici keramike tankih stijenika (T. 18: 9), a pored njih pronađene su i staklene čaše. Iako je sva keramika na lokalitetu jako usitnjena, uočava se kako nedostaju čaše. Staklenog posuđa također ima vrlo malo. Može li se pretpostaviti da su za piće koristili čaše izrađene od drveta?

#### *Panonska imitacija pompejanskih tanjura*

Ovdje se ubrajaju tanjuri koji nisu izrađeni od strukture VKJ 2 koja je lokalne proizvodnje. Od 1. do 4. st. u Panoniji je zabilježena prisutnost velikog broja tanjura koji imitiraju italske, pompejanske tanjure. S obzirom na raznolikost struktura, pretpostavlja se postojanje većeg broja radionica. Sigurno je da su se proizvodili u Ptuj (Istenić 1999: 117–119). Većina takvih tanjura s lokaliteta Virovitica Kiškorija jug pripada strukturi VKJ 13 i oblikom odgovaraju tipu T2 prisutnom i u lokalnoj varijanti (T. 2: 4; T. 2: 13; T. 8: 12; T. 8: 13; T. 17: 5; T. 18: 4; T. 21: 12), a zastupljene su strukture 16 i 23 (T. 19: 7; T. 20: 2; T. 20: 7). Posuđe ovog tipa zastupljeno je na brojnim objavljenim lokalitetima u Panoniji (Vikić-Belančić 1965: sl. 36; Brukner 1981: 39; Košćević, Makjanić 1986: sl. 5; Nemeth-Ehrlich 1994: 133; Ožanić 1998: T. 4–7; Wiewegh 2001: 95–96; Bačani et al. 2011: 112–124).

S obzirom na veliku zastupljenost ovog oblika, moralo je postojati više proizvodnih centara ove vrste posuđa (Siscija, Mursa, Petovij, Cibale).

their production. The other fragments are tinier and they could be parts of jugs (Pl. 15: 14; Pl. 21: 9).

The fragment Cat. No. 139 (Pl. 17: 7) belonged to a smaller pot or a jug, but it cannot be precisely typologically and chronologically determined. Apart from that fragment, fragments of bowls were found (Pl. 24: 5; Pl. 28: 5). Cat. No. 214 resembles late Antique bowls with a horizontal rim and a glaze, which date to the 3<sup>rd</sup> and the 4<sup>th</sup> century.

#### *With painting*

Several fragments were found, with a thick red slip, of a vessel's shoulder, body or base, which belonged to jugs or pots (Pl. 5: 9; Pl. 9: 12; Pl. 18: 8). These fragments have a different and undefined fabric and they were undoubtedly imported to the site.

Fragments of two bowls were found, which are an imitation of the *sigillata* shape Drag. 37. The *sigillata* of that shape is present in Pannonia in large quantities (Brukner 1981: 21; Ožanić 1998: T. 1). The bowl Cat. No. 181 imitates the *sigillata* shape Drag. 32 (Pl. 20: 15), and it dates to the second half of the 2<sup>nd</sup> and the 3<sup>rd</sup> century, but it is also present earlier as a shape inherited from the La Tène period. They are not an isolated find, they are present on several sites in Pannonia (Ožanić Roguljić 2009: 84).

Only two cups were found on the site. One of them is Cat. No. 126 (Pl. 16: 5), an indented cup (*Faltenbecher*), red firing colour and with a glossy thick slip, from the 2<sup>nd</sup> century. The production of this type was registered in Ptuj (Istenić 1999: 117–118). The other cup was made in the thin-wall technique (Pl. 18: 9). Besides them, glass cups were also found. Even though all of the ceramics from the site are very fragmented, we can notice the absence of cups. There is very little glassware. Can we assume that they used wooden cups for drinking?

#### *Pannonian imitation of the Pompeian plates*

These are the plates which do not have locally produced VKJ 2 fabric. Numerous plates that imitate the Italic and Pompeian plates are present in Pannonia, from the 1<sup>st</sup> to the 4<sup>th</sup> century. Since they have various fabrics, it can be assumed that there was a larger number of workshops. They were certainly produced in Ptuj (Istenić 1999: 117–119). Most of these plates from the Virovitica Kiškorija south site have the VKJ 13 fabric and their shape is similar to the T2 type, which is also represented in a local version (Pl. 2: 4; Pl. 2: 13; Pl. 8: 12; Pl. 8: 13; Pl. 17: 5; Pl. 18: 4; Pl. 21: 12). Fabrics 16 and 23 are present as well (Pl. 19: 7; Pl. 20: 2; Pl. 20: 7). This type of dishes is present on numerous published sites in Pannonia (Vikić-Belančić 1965: sl. 36; Brukner 1981: 39; Košćević, Makjanić 1986: sl. 5; Nemeth-Ehrlich 1994: 133; Ožanić 1998: T. 4–7; Wiewegh 2001: 95–96; Bačani et al. 2011: 112–124).

Considering the large presence of this shape, there must have been several production centres for this type of dishes (*Siscia, Mursa, Poetovium, Cibale*).





## Usporedba uporabne keramike lokalne proizvodnje s lokaliteta Virovitica Kiškorija Jug s takvom keramikom okolnih mikroregija

### Comparing the locally produced functional ceramics from the Virovitica Kiškorija South Site to the similar ceramics produced in neighbouring micro-regions

Kako bi se mogla usporediti uporabna keramika lokalne proizvodnje pregledan je keramički materijal koji se čuva u Arheološkom muzeju u Zagrebu s lokaliteta: Jalžabet - Bartolovec (Jelinčić 2009: T. 43–51), *Iovia/Botivo* (Ludbreg), (Jelinčić 2009: T. 52–59), *Pyrrri* (Komin) (Jelinčić 2009: 67–71), Gornji Čehi (Jelinčić 2009: T. 72), Mala Mlaka – Ciglenica (Jelinčić 2009: T. 72), Mala Mlaka - Starče (Jelinčić 2009: T. 75), Turopoljski lug (Jelinčić 2009: T. 74), *Andautonia* (Ščitarjevo), (Jelinčić 2009: T. 89–105). Pregledana je keramika s lokaliteta *Aqua viva* (Petrijanec) (Jelinčić 2009: T. 60–66) koja se čuva u Gradskom muzeju Varaždin, keramika iz Topuskog (Jelinčić 2009: T. 106–113), koja se čuva u Gradskom muzeju Karlovac, keramika s više lokaliteta u gradu u Sisku koja se nalazi u Gradskom muzeju Sisak (Jelinčić 2009: T. 113–132), keramika s više lokaliteta s područja Brdovca (Zavičajni muzej Brdovec), (Jelinčić 2009: T. 133–143), Ciglenice - Osekovo i Kutinske lipe (Jelinčić 2009: T. 144–153) iz Muzeja Moslavine Kutina, keramika pronađena prilikom zaštitnih arheoloških radova na trasi autoceste na lokalitetima Okuje (Jelinčić 2009: T. 86–88) i Šepkovčica (Jelinčić 2009: T. 76–85), (istraživanja proveli Muzej grada Zagreba i Kaducej), (Karta 3). Pregledane su i posude s lokaliteta Radovanci - Brdo koje se čuvaju u Gradskom muzeju Požega kao i keramika s lokaliteta Tekić.<sup>1</sup>

Za razmatranje od velike je važnosti i keramički materijal s lokaliteta Orešac koji je u izradi doktorske disertacije bio ključan pri određivanju karakteristika mikroregije u kojoj se nalazi Kiškorija (Jelinčić 2009). Orešac - *Bolentio* odnosno *Bolenta* iz itinerara poznat kao *mutatio*, smješten je na samoj cesti *Poetovio – Mursa* (*Itinerarium Hierosolymitanum/Burdigalense* 560–63; Kukuljević-Sakcinski 1873: 108;

In order to carry out the comparison of the locally produced functional ceramics, the ceramics from the following sites: Jalžabet - Bartolovec (Jelinčić 2009: T. 43–51), *Iovia/Botivo* (Ludbreg), (Jelinčić 2009: T. 52 – 59), *Pyrrri* (Komin) (Jelinčić 2009: 67–71), Gornji Čehi (Jelinčić 2009: T. 72), Mala Mlaka - Ciglenica (Jelinčić 2009: T. 72), Mala Mlaka - Starče (Jelinčić 2009: T. 75), Turopoljski lug (Jelinčić 2009: T. 74), *Andautonia* (Ščitarjevo), (Jelinčić 2009: T. 89–105) have been re-examined. The abovementioned ceramics are kept at the Zagreb Archaeological Museum. In addition, the following ceramics have been re-examined as well: the *Aqua viva* ceramics (Petrijanec) (Jelinčić 2009: T. 60–66), kept at the Varaždin City Museum; the ceramics from Topusko (Jelinčić 2009: T. 106–113), kept in the Karlovac City Museum; the ceramics from several sites in Sisak (Jelinčić 2009: T. 113–132), kept at the Sisak City Museum; the ceramics from several sites in the Brdovec area (Brdovec County Museum), (Jelinčić 2009: T. 133–143), Ciglenica - Osekovo and Kutinska Lipa (Jelinčić 2009: T. 144–153), kept at the Kutina Museum of Moslavina; the ceramics retrieved during the protective archaeological works at the motorway construction site at Okuje (Jelinčić 2009: T. 86–88) and Šepkovčica (Jelinčić 2009: T. 76–85), (research conducted by the Zagreb City Museum and Kaducej), (Map 3). The vessels from the Radovanci - Brdo site kept at the City Museum and the ceramics from the Tekić site were re-examined as well.<sup>1</sup>

The ceramics from the Orešac site, which played a key role in determining the characteristics of the Kiškorija micro-region in my doctoral dissertation, were very important for the study as well (Jelinčić 2009). Orešac – *Bolentio*, i.e. *Bolenta* also known as *mutatio*, is situated on the *Poetovio – Mursa* road (*Itinerarium Hierosolymitanum/Burdiga-*

1 Zahvaljujem se svim kolegama što su mi omogućili uvid u građu koja se čuva u muzejima (Arheološki muzej u Zagrebu (Z. Gregl, D. Nemeth - Ehrlich, D. Kušan Špalj), Gradski muzej Varaždin (Marina Šimek), Gradski muzej Sisak (Tea Tomaš Barišić), Zavičajni muzej Brdovec (Ivan Cvitković), Muzej Moslavine Kutina (Ana Bobovec), Saša Bugar (Muzej grada Zagreba), Josip Burmaz (Kaducej), Mirela Pavličić (Gradski muzej Požega).

1 I wish to thank all the colleagues who were as kind as to grant me an access to artefacts kept in the museums (Zagreb Archaeological Museum (Z. Gregl, D. Nemeth - Ehrlich, D. Kušan Špalj), Varaždin City Museum (Marina Šimek), Sisak City Museum (Tea Tomaš Barišić), Brdovec County Museum (Ivan Cvitković), Kutina Museum of Moslavina (Ana Bobovec), Saša Bugar (Zagreb City Museum), Josip Burmaz (Caduceus), Mirela Pavličić (Požega City Museum).



Soproni 1980: 213), (Karta 3).

Karakter nalaza iz višegodišnjih istraživanja Orešca govori da se na tom mjestu nije samo nalazila stanica za izmjenu konja već bogato naselje budući da je u istraživanjima pronađena raznovrsna građa različitog podrijetla (Salajić 2008: 67–72). To ne iznenađuje, s obzirom na činjenicu da su se putne stanice nalazile kod bogatih gospodarskih zgrada ili kao zasebni objekti sa različitim sadržajima za okrpju, prodavaonicama, gostionicama, kupalištima, prostorijama za povremenu pohranu robe koja se prevozi (Šonje 1991: 41).

Ipak, lokalno izrađena keramika s ovog lokaliteta je tipološki, tehnološki i strukturalno srodna keramici lokalne proizvodnje s lokaliteta Virovitica Kiškorija jug i ne predstavlja provincijsku proizvodnju već lokalnu proizvodnju ovog kraja. Terenskim pregledom lokaliteta Macute–Lenija (karta 3), koji je poznat po brojnim prapovijesnim nalazima (Salajić 2002: 70–73), uočena je nekolicina antičkih nalaza–keramike koja je tehnološki srodna nalazima iz Orešca i Virovitice Kiškorije jug.

Zbog toga bi ovaj lokalitet zajedno s lokalno izrađenom keramikom s Virovitice Kiškorije jug i Orešca mogao činiti svojevrsnu mikroregiju. Lokalitet Macute – Lenija nalazi se južno od ceste koja iz Voćina vodi za Slatinu i od nje ga je udaljen 6,7 km i oko 36 km od Orešca. Istoj mikroregiji pripada i lokalitet Radovanci – Brdo gdje je pronađena nekropola iz 4. st. (Sokač–Štimac 1976: 89–90, T. XXXVIII). U grobovima je pronađeno keramičko posuđe analogno posuđu iz Virovitice Kiškorije jug po strukturi (VKJ 2) i oblicima. Keramika koja je po svojim obilježjima srodna VKJ 2 strukturi zabilježena je i na lokalitetu Tekić (naselje). Od ukupne grube keramike u Tekiću, keramika koja je srodna VKJ 2 strukturi čini njezin manji dio.

Prema objavljenoj literaturi i nalazima s koprivničkog područja gdje je uočena keramika lokalne izrade s dosta pijeska, taj keramički materijal više nalikuje keramici Virovitičkog područja nego keramici ludbreškog kraja (Marković 1984: 300, T. 8: 4, 5, 8; 1993: 27, T. 1. 7). Prilikom istraživanja lokaliteta Virje - Volarski breg/Sušine pronađena je kasno-latenska keramika (Sekelj Ivančan 2014: 102–103) koja po svojoj strukturi i oblicima jako podsjeća na keramiku iz mikroregije kojoj pripada Virovitica Kiškorija jug. Ipak, treba imati na umu da je područje znatno bliže Ludbregu te da je bez vrlo detaljne makroskopske i tipološke analize teško odrediti je li materijal koprivničkog kraja srodniji ludbreškom ili virovitičkom keramičkom materijalu.

Nakon pregleda literature i keramike iz Ludbrega, Jalžabeta, Petrijanca i Varaždinskih Toplica (Vikić–Belančić 1965: 89–112; 1967; 1968b: 76–102; 1972.–1973 (1974): 75–127; 1975: 25–45; 1983.–1984: 119–166) te uvidom u građu s lokaliteta Ludbreg (Jelinčić 2009: T. 52–59), Jalžabet (Jelinčić 2009: T. 43–51) i Petrijanec (Jelinčić 2009: T. 60–66), jasno je kako se lokalno izrađena keramika koja se koristila na ta četiri lokaliteta mnogo razlikuje od prethodno opi-

lense 560–63; Kukuljević–Sakcinski 1873: 108; Soproni 1980: 213), (Map 3).

The character of the finds resulting from years-long research of Orešac would indicate that not only the post of exchange but also an elaborate settlement was at that particular location, since the research revealed a variety of archaeological material of different origin (Salajić 2008: 67–72). This should not come as a surprise bearing in mind a fact that the exchange posts were located next to wealthy estates or as separate structures with different facilities such as shops, inns, baths, storage rooms, etc. (Šonje 1991: 41).

Nevertheless, the locally produced ceramics from this particular site correspond, typologically, technologically and with its fabric, to the ceramics produced at the Virovitica Kiškorija South site, thus representing the local production of this region rather than the provincial one. Field re-examination of the Macute–Lenija site (Map 3), reputed for its numerous prehistoric finds (Salajić 2002: 70–73), revealed few antique finds – pieces of ceramics, technologically similar to the Orešac and Virovitice Kiškorije south finds.

Whence, this site, along with the locally produced ceramics from Virovitice Kiškorije south and Orešac, could make a specific micro-region. The Macute–Lenija site is located south of the road leading from Voćin to Slatina, 6.7 kilometres from the Macute - Lenija site and 36 kilometres from Orešac. The Radovanci–Brdo site, where the 4<sup>th</sup> century necropolis was found, belongs to the very same micro-region (Sokač–Štimac 1976: 89–90, T. XXXVIII). Ceramic vessels, analogous in fabric (VKJ 2) and form to the ceramics from the Virovitice Kiškorije south site, were retrieved from the graves. The ceramics of the characteristics similar to the VKJ 2 fabric have also been found at the Tekić site (settlement). Only a small portion of the coarse ceramics at the Tekić site corresponds to the VKJ 2 fabric.

According to published literature and the finds from the Koprivnica area, where the locally produced ceramics made with plenty of sand were found, this ceramic material resembles to the Virovitica ceramics rather than to the ceramics from the Ludbreg area (Marković 1984: 300, T. 8: 4, 5, 8; Marković: 27, T. 1. 7). During the research of the Virje - Volarski Breg/Sušine site, the late La Tène period (Sekelj Ivančan 2014: 102–103) ceramics were found, resembling in both fabric and form to the ceramics of the Virovitica Kiškorija South micro-region. However, one has to bear in mind that the subject area is much closer to Ludbreg and that it would take a detailed microscopic and typological analysis to determine whether the Koprivnica material is related to the Ludbreg or to the Virovitica ceramic material.

After having reviewed relevant literature and the ceramics from Ludbreg, Jalžabet; Petrijanec and Varaždinske Toplice (Vikić–Belančić 1965: 89–112; 1967; 1968b: 76–102, 1972.–1973 (1974): 75–127; 1975: 25–45; 1983.–1984: 119–166), and after having accessed the archaeological material from the Ludbreg (Jelinčić 2009: T. 52–59), Jalžabet (Jelinčić 2009: T. 43–51) and Petrijanec (Jelinčić 2009: T. 60–66) sites, it becomes clear that the locally produced ceramics used

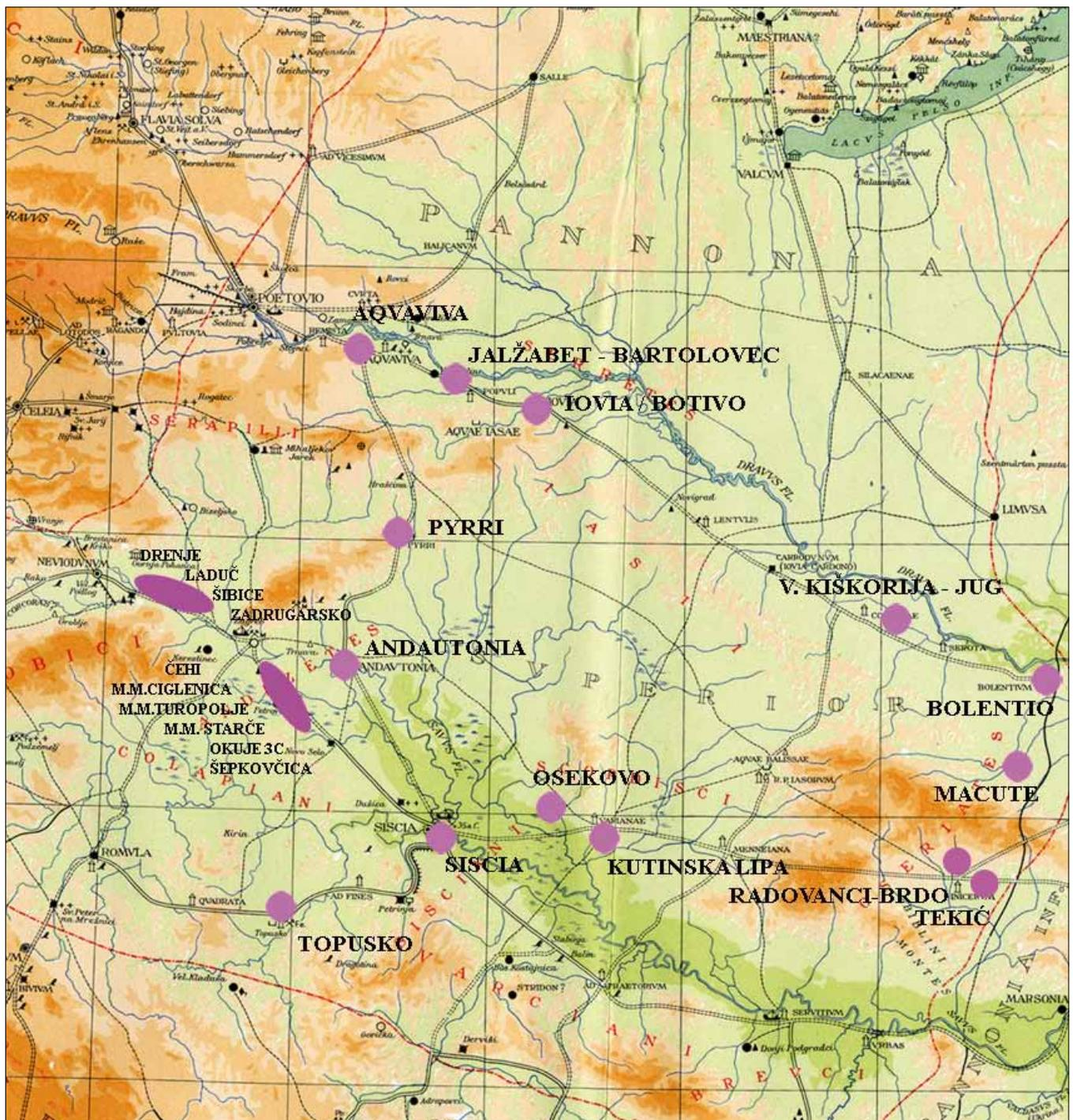

Karta 3 TIR foglio L 33 (isječak) Lokalizeti čiji je materijal pregledan municipija smještenog na mjestu današnjeg Daruvara – Aquae Ballissae i Gornjoj Panoniji

Map 3 TIR foglio L 33 (section) The sites where the re-examined material was found, from the location situated at the place of the present-day Daruvar – Aquae Ballissae and Upper Pannonia

sane virovitičke mikroregije: tipološki, strukturalno, ali i dekorativno. Istovremeno, lokalno proizvedena keramika "ludbreškog" područja ima neka zajednička tipološka, tehnološka i strukturalna obilježja te zbog toga čini zasebnu cjelinu. Pored tih zajedničkih osobina uočeni su pojedini keramički tipovi, karakteristični za svaki od lokaliteta. To najviše pokazuje složenost ove teme i potrebu da se sustavno pristupi obradi ove vrste keramike zasebno za svaki lokalitet. U Ludbregu, Petrijancu i Jalžabetu prisutan je tip

on these four locations differ significantly from the above described ceramics of the Virovitica micro-region, both in typology and in fabric, as well as in decoration. At the same time, the locally produced ceramics of the Ludbreg area have certain shared typological, technological and fabric characteristics making it a separate unit. Apart from these common features, individual types of ceramics, representative of the each of the sites, were also detected. This only goes to illustrate the complexity of the subject as well as the need to interpret this type of ceramics systematically



lonca L4, ali je strukturalno mnogo drukčiji od lonaca takvog tipa na Orešcu i Virovitici Kiškorijski jug. U Ludbregu je s više primjeraka dokumentiran takav lonac oštrog profila i koso izvijenog oboda i koso oblikovanog ramena.

Ipak, iako je taj tip lonca prisutan i na Jalžabetu, kod ovih lonaca (Jelinčić 2009: T. 54: 1–3; T. 55: 1) prisutne su strukturalne razlike. Ovaj tip zastupljeniji je s većim brojem primjeraka u Ludbregu. Na Jalžabetu se javljaju i tipovi posuda većih dimenzija, za čuvanje hrane, koji su bogato ukrašeni češljastim ukrasima. Pregledom materijala uočena je veća količina ulomaka koji su pripadali ovom tipu posuda. Ovi tipovi predstavljaju specifičnost lokaliteta Jalžabet (Jelinčić 2009: T. 45: 1–3; 46: 1; 47: 1–2; 48: 1) i Petrijanec (Jelinčić 2009: T. 65: 6–9; T. 66: 1, 3). Na Jalžabetu je pronađen i lonac tipa L1 koji je kao tip jako zastupljen u Gornjoj Panoniji (Jelinčić 2009: T. 48: 2), zatim više ulomaka trbuha ukrašenih češljastim ukrasom i pripadajućih oboda velikih lonaca za čuvanje hrane (Jelinčić 2009: T. 49: 1–2; T. 50–51), izrađenih rukom. Ovi veliki lonci nisu pronađeni na okolnim lokalitetima te predstavljaju specifičnost za Jalžabet barem što se tiče oblikovanja njihovog oboda.

Tarionici s Jalžabeta (Jelinčić 2009: T. 44: 1–2) su kao oblik prisutni i na drugim lokalitetima u Gornjoj Panoniji: Ludbreg (Jelinčić 2009: T. 52: 3, T. 53: 3/4), Sisak (Jelinčić 2009: T. 114: 1), Petrijanec (Jelinčić 2009: T. 60: 2). Svi se tarionici razlikuju u svojoj strukturi, boji pečenja keramike i glazuri. Raznolikost oblikovanja detalja na svim tim tarionicima i njihove izrade upućuje na lokalni karakter proizvodnje i ovog tipa posuda i to ne isključivo u velikim radioničkim centrima nego diljem provincije, te stoga i u manjim gradovima i naseljima. Za Ludbreg prije svega treba izdvojiti brojnost lonca tipa L4 i raznolikost struktura od koje je izrađen (Jelinčić 2009: T. 54: 1–3; T. 55). Od druge keramike zanimljiv je lonac koji je ukrašen (Jelinčić 2009: T. 58: 1) na ramenu i obodu s vanjske i unutrašnje strane, a zapravo se radi o tipu lonca koji je najzastupljeniji u Kominu (Jelinčić 2009: T. 69–70). Na drugim lokalitetima ovaj tip lonca za sada nije uočen.

U Ludbregu je pronađen i tip lonca S profila (Jelinčić 2009: T. 59: 1) s vrlo naglašenim ramenom i vodoravnim urezanim ukrasom koji počinje od ramena na niže. Takav tip lonca najzastupljeniji je u Ščitarjevu, međutim takve posude iz Ščitarjeva (Jelinčić 2009: T. 99–103) su strukturalno i tehnološki razlikuju od ove posude iz Ludbrega.

Keramika iz Petrijanca pokazuje srodnost s keramikom na lokalitetima Ludbreg i Jalžabet - Bartolovec. To se vidi na tarionicima i velikim loncima za pohranu hrane sive i smeđe boje koji su bogato češljasto ukrašeni (Jelinčić 2009: T. 60: 2; T. 65: 6–9; T. 66: 1). Keramika iz Petrijanca ipak više analogija ima na vili u Jalžabetu nego u Ludbregu, a to se odnosi na sivo pečenu keramiku ukrašenu različitim češljastim ukrasima (Jelinčić 2009: T. 45: 1–3; T. 46: 1; T. 48: 1; T. 49: 2; T. 50: 2; T. 65: 6–9; T. 66: 1–3). Ukras i tehnologija izrade kod ove keramike su slični međutim oblikovanje posude se

and separately for each of these sites. The pot of L4 type is found in Ludbreg, Petrijanec and Jalžabet, but its fabric differs significantly from the one of the same type found at Orešac and Virovitica Kiškorijski south. A number of examples of this type of pot featuring sharp profile and slanting rim and sloping shoulder have been found in Ludbreg.

Although this type of pot can also be found at Jalžabet, these pots (Jelinčić 2009: T. 54: 1–3; T. 55: 1) exhibit some structural differences. This type is quite well represented in Ludbreg. At Jalžabet, one can find somewhat larger vessels intended for food preservation, lavishly decorated with comb-shaped ornaments. Re-examination of the archaeological material revealed a large quantity of fragments belonging to this type of kitchen utensils. These particular types represent a specific quality of the Jalžabet (Jelinčić 2009: T. 45: 1–3; 46: 1; 47: 1–2; 48: 1) and Petrijanec (Jelinčić 2009: T. 65: 6–9; T. 66: 1, 3) sites. A pot of L1 type has also been found at Jalžabet; this type was also frequent in Upper Pannonia (Jelinčić 2009: T. 48: 2), as was the case with a number of fragments of bodies of vessels decorated with the comb-shaped pattern and appertaining rims of large hand-made pots used for food preservation (Jelinčić 2009: T. 49: 1–2; T. 50–51). These large pots have not been found at nearby sites and they are specific for the Jalžabet area, at least when it comes to the shape of their rim.

The mortaria shape from Jalžabet (Jelinčić 2009: T. 44: 1–2) is present at other sites in Upper Pannonia as well: Ludbreg (Jelinčić 2009: T. 52: 3, T. 53: 3–4), Sisak (Jelinčić 2009: T. 114: 1), Petrijanec (Jelinčić 2009: T. 60: 2). The mortaria differ in fabric, colour of baking and glazing. The variety of details on all of these mortaria refer to local character of production of this type kitchen utensils, not only and exclusively in big production centres, but also all over the province, i.e. in small townships and settlements as well. It has to be pointed out, as far as Ludbreg is concerned, that the type L4 pot is quite widespread. Equally interesting is the fabric it was made of (Jelinčić 2009: T. 54: 1–3, T. 55). When it comes to the rest of the ceramic material, we may single out a pot (Jelinčić 2009: T. 58: 1) decorated on both inside and outside of both shoulder and rim. In fact, we are dealing here with the type of a pot which is most frequently found at Komin (Jelinčić 2009: T. 69–70). This type of pot has not been found at other sites for the time being.

A pot with S-profile was found in Ludbreg (Jelinčić 2009: T. 59: 1) with prominent shoulder and horizontal ornament engraved at the shoulder and going downwards. This type of pot is most frequent in Ščitarjevo; however, such vessels from Ščitarjevo (Jelinčić 2009: T. 99–103) differ from this vessel from Ludbreg, both in fabric and technologically.

The Petrijanec ceramics bear analogy with the ceramics at the Ludbreg and Jalžabet-Bartolovec sites. This is evident on mortaria and large grey and brown lavishly decorated pots with comb-shaped ornaments, used for food preservation (Jelinčić 2009: T. 60: 2, T. 65: 6–9, T. 66: 1). However, the Petrijanec ceramics display more analogy on a villa at Jalžabet rather than on the one in Ludbreg, this pertaining to grey baked ceramics with different comb-shaped ornaments (Jelinčić 2009: T. 45: 1–3, T. 46: 1, T. 48: 1,



razlikuje u obodu (Jelinčić 2009: T. 45: 1–2; T. 49: 1; T. 56: 1–2; T. 63: 3, 5; T. 66: 1–2). Tarionici su na prvi pogled analogni na sva tri susjedna lokaliteta, međutim nisu u potpunosti isti bez obzira o kojem se tipu tarionika radi, a razlikuju se i u boji pečenja (Jelinčić 2009: T. 44: 1–2; T. 52: 3; T. 53: 1–3; T. 60: 2). Od manjih posuda prisutno je više tipova lonaca od kojih lonac s koso izvijenim vratom i koso oblikovanim ramenom oštrog profila svoje analogije nalazi na Jalžabetu, a naročito u Ludbregu. Strukturalno među njima postoje razlike (Jelinčić 2009: T. 43: 1; T. 54; T. 55; T. 61: 1). U Petrijancu prisutan je veći broj različito oblikovanih lonaca s jedva naglašenim obodom (Jelinčić 2009: T. 61: 3–5; T. 62: 1, 3), tip koji je kao i češljasto ukrašavanje dio prapovijesnih tradicija u oblikovanju posuda. Posude za čuvanje hrane u Petrijancu su bolje izrade od malih lonaca za kuhanje. Lonci za čuvanje su dobro pečeni, postojanog premaza, ne otiru se, dok se mali lonci mrve, otiru i loše su pečeni.

Postojanje istih tipova na pojedinim lokalitetima ne znači nužno i njihovu strukturalnu srodnost. Oni mogu biti izrađeni različitim tehnikom, od različite sirovine i pečeni na različitim način. Njihova strukturalna različitost govori različitoj sirovini, lončaru te vjerojatno i različitim mjestu proizvodnje. Isto tako moguća je njihova drugačija namjena radi drugačijeg sastava.

*Pyrri* (Komin) se nalazi na važnoj cesti koja je povezivala Sisak i Ščitarjevo preko Ludbrega s Ptujem. Istraživanja su pokazala kako se tu najvjerojatnije nalazilo naselje, a ne samo postaja za izmjenu konja (Nemeth-Ehrlich 1986a: 23; Gorenc, Nemeth-Ehrlich 1985: 103–104; Domić Kunić 2003: 285). Iako se radi uglavnom o dosta usitnjenim ulomcima keramike prepoznaju se dvije vrlo karakteristične strukture i dva tipa posuda. Uočena je znatna količina rukom izrađene keramike s velikom količinom primjesa pljeve i drugih primjesa biljnog podrijetla (Jelinčić 2009: T. 67–68). Struktura takve keramike nije uočena na drugim lokalitetima i čini specifičnost tog naselja. Drugi tip lonaca i strukture pripada manjim loncima izvijenog oboda s dosta tinjca i kvarca koji imaju ukrašene obode s vanjske i unutarnje strane kao i tijelo posude (Jelinčić 2009: T. 69–70). Taj tip je s jednim primjerkom pronađen i u Ludbregu (Jelinčić 2009: T. 58).

Žumberak pripada širem municipalnom području municipija smještenog kod Drnova. Taj *Municipium Flavium Latobicorum Neviodunum* obuhvaćao je područje koje su nastavali Latobici, a njihova keramička ostavština poznata je većim dijelom iz istraživanja nekropola. Iako se taj materijal ne može poistovjeđivati s uporabnom keramikom upotrebljavanom u kućanstvu, količina i karakter tog keramičkog materijala pokazuju izvjesne specifičnosti karakteristične samo za taj "latobiški" kraj. Neke od posuda koje su karakteristične za taj kraj kao što su lonci s narebrenim vratom, ponekad se javljaju u Drenju, Stenjevcu, Sisku i Andautoniji te u Šepkovčici, ali tamo znatno manje. To područje razlikuje se od svih ostalih i po tome što je u njemu

T. 49: 2, T. 50: 2, T. 65: 6–9, T. 66: 1–3). Ornaments and production technology are similar on this type of ceramics, but shapes of the vessels differ when it comes to their rim region (Jelinčić 2009: T. 45: 1–2, T. 49: 1, T. 56: 1–2, T. 63: 3, 5, T. 66: 1–2).

At first glance the mortaria are analogous at all three neighbouring sites; nevertheless, they are not identical, regardless of the type; also, they differ in colour (Jelinčić 2009: T. 44: 1–2, T. 52: 3, T. 53: 1–3, T. 60: 2). Several types of smaller pots have been found; one of them, i.e. the one with the sloping twisted neck and slanted shoulder of sharp profile has its analogies at Jalžabet, and at Ludbreg in particular. They differ in fabric (Jelinčić 2009: T. 43: 1, T. 54, T. 55, T. 61: 1). A large number of differently shaped pots with slightly accentuated rim have been found in Petrijanec (Jelinčić 2009: T. 61: 3–5, T. 62: 1, 3); this is the type, just as is the comb-shaped decoration, which is a part of a prehistoric tradition of the vessel design. The vessels used for food preservation from Petrijanec were manufactured with better workmanship than small pots used for cooking. Pots for food preservation are well baked, they have consistent slip and they would not rub off, whereas small pots are poorly baked, they break easily into small pieces and rub off.

The existence of these types at certain localities does not necessarily mean that their fabric is analogous. They could have been baked in a different way and manufactured using different techniques and different material. The diversity of their fabric suggests a different material, a different potter and, probably, a different place of production. Also, they might have been used for some other purpose as suggested by their different composition.

*Pyrri* (Komin) is situated on an important route connecting Sisak with Ščitarjevo and with Ptuj via Ludbreg. The researches showed that not only a place for changing horses was there, but a settlement as well (Nemeth-Ehrlich 1986a: 23; Gorenc, Nemeth-Ehrlich 1985: 103–104; Domić Kunić 2003: 285). Although there was only rather fragmented ceramic material found at the site, one can identify two distinct fabrics and two types of vessels. Considerable quantity of hand-made ceramic material with a large amount of winnow inclusion and other vegetable admixtures has been identified (Jelinčić 2009: T. 67–68). Fabric of such ceramics has not been observed on other sites and it is specific for this particular settlement. Another type of pots are smaller pots with bent rim, with a greater content of mica and quartz, with rims decorated in the same way as the body of a vessel, both on the inside and on the outside (Jelinčić 2009: T. 69–70). One pot of this type was also found in Ludbreg (Jelinčić 2009: T. 58).

Žumberak belongs to a general municipal area of the municipality located at Drnovo. This *Municipium Flavium Latobicorum Neviodunum* covered the area inhabited by Latobics whose ceramic heritage has become known through the research of the necropolis. Although this material cannot be identified with the functional ceramics used in households, the quantity and character of this ceramic material bears certain specific characteristics to this particular "Latobian" region only. Some of the vessels typi-



mnogo veća prisutnost rimskog utjecaja (Plesničar - Gec 1977, 166; Gregl 1989; Knez 1992, Gregl 2002: 82–91; Gregl 2003: 469–479; Nemeth-Ehrlich, Kušan Špalj 2003: 122, Fig. 30; Gregl 2007: 221–332).

Municipalni prostor Ščitarjeva (Karta 3) su naseljavali Varcijani (Domić Kunić 2003: 169–179; Nemeth-Ehrlich, Kušan Špalj 2003: 111; 2007: 20). Može li se tu očekivati zaokružena cjelina sa specifičnim keramičkim materijalom kao nešto zapadnije na području municipija Neviodunum? Preostaje samo pričekati s objavu mnogobrojne keramičke građe pronađene na više položaja u Ščitarjevu. Djelomičnim uvidom u građu (Jelinčić 2009: T. 89–105) jasno je samo kako se taj materijal (lokalno proizvedena keramika) razlikuje od keramičke građe područja oko Siska i Neviodunuma.

Lokaliteti Mala Mlaka - Ciglenica, Mala Mlaka - Starče (Jelinčić 2009: T. 72–75) pokazuju neke tipološke sličnosti što ne iznenađuje s obzirom na blizinu tih lokaliteta. Ščitarjevo se nalazilo na cesti koja je spajala Sisciju s Podravinom, a nešto južnije ta se cesta spajala s važnom prometnicom koja je spajala Emonu sa Siscijom i dalje Mursom i Sirmijem. Također tu je i Sava koja je bila plovna sve do Ljubljane prelaskom na rijeku Ljubljanicu, kojom se dalje moglo stići sve do Nauporta. O važnosti plovnih putova govore i carske odluke da veterani koji su služili na brodovima ciljano dobiju zemlju duž ovih važnih rijeka (Zaninović 1993: 55–56), a važnost ovih riječnih putova od Italije pa sve do krajnjeg istoka Dunavom prepoznata je još i u prapovijesti (Šašel Kos 2003: 13).

Pretpostavlja se da je Andautonija bila važna luka (Nemeth-Ehrlich, Kušan Špalj 2003: 107) iako za to još nisu pronađene arheološke potvrde. To je sigurno donijelo mnogo utjecaja na ovaj lokalitet od kojih su neki mogli djelovati na formiranje i ukrašavanje posuda. Moguće je da je to uzrok raznolikim tipovima posuda, a brojne strukture mogu ukazivati i na intenzivnu lokalnu proizvodnju, više obrtnika kroz dugo razdoblje života na ovom lokalitetu, te različitu sirovinu uzimanu sa šireg područja grada. Uvidom u građu zaključeno je kako postoji nekoliko struktura koje dominiraju među uporabnom keramikom te nekoliko tipova koji se češće ponavljaju. Ta raznovrsnost prisutnija je nego na manjim lokalitetima čiji je materijal pregledan. Uzrok tome je vjerojatno veličina naselja, intenzitet života i broj lončara koji je djelovao u njemu.

Keramika koja se pregledom građe izdvaja svojom većom količinom je crno pečeno posuđe, u presjeku crvene boje pečenja. Radi se o loncima, zdjelama, cjediljkama i tronošcima koji su izrađeni sa vrlo usitnjenim primjesama (Jelinčić 2009: T. 99–104). Ovakve posude nisu uočene na drugim lokalitetima u toliko velikom broju (Jelinčić 2009: T. 72: 1–2). Među pregledanom keramikom ističu se posude S profilacije latenske tradicije s jako naglašenim ramenom (Jelinčić 2009: T. 96: 1; T. 97: 2–4, T. 98, 99, 100, 101, 103, 104, 105). Površina posuda iz Ščitarjeva često je češljasto ukra-

cal for the area, such as the pots with ribbed neck, sometimes can be found in Drenje, Stenjevec, Sisak and Andautonia, as well as in Šepkovčica, though not in larger quantities. This area differs from any other due to a fact that the influence of Rome was much greater there. (Plesničar Gec 1977, 166; Gregl 1989; Knez 1992, Gregl 2002, 82–91; Gregl 2003, 469–479; Nemeth-Ehrlich, Kušan Špalj 2003, 122, Fig. 30; Gregl 2007, 221–332).

The municipal area of Ščitarjevo (Map 3) was inhabited by the Varcians (Domić Kunić 2003, 169–179; Nemeth-Ehrlich, Kušan Špalj 2003, 111; 2007: 20). One wonders if one could expect to find an integral system with a specific ceramic material, something like in the area of the municipality of Neviodunum? To get an answer to that question one has to wait and see the published data on the ceramic material found on several locations in Ščitarjevo. Partial insight (Jelinčić 2009: T. 89–105) enabled us only to understand that this material (locally produced ceramics) differs from the ceramic material in the area around Sisak and Neviodunum.

The Mala Mlaka - Ciglenica, Mala Mlaka - Starče sites (Jelinčić 2009: T. 72–75) display some typological similarities, which is not surprising given their relative vicinity. Ščitarjevo was located on the road connecting *Siscia* with Podravina; going to the south, this road adjoined an important communication route linking *Emona* and *Siscia* as well as with *Mursa* and *Sirmium*. Also, there was the Sava river, which used to be navigable up to Ljubljana, so that one could have navigated all the way to Nauport via the Ljubljanica river. The importance of navigational routes is mentioned in Emperor's decrees, which stated that the veterans who had served on ships were to be granted estates along these significant river routes (Zaninović 1993: 55–56), significance of which had been recognised even in prehistoric times when these inland navigation routes connected Italy and east Europe via Danube (Šašel Kos 2003: 13).

It has been assumed that *Andautonia* was an important port (Nemeth-Ehrlich, Kušan Špalj 2003: 107), though we still do not have any firm archaeological evidence. This must have had an enormous influence on this site and its production practices, including the way the vessels were designed and decorated. It is quite possible that these developments caused the emergence of a variety of vessel types, while a number of fabrics may indicate an intensive local production by different manufacturers over a lengthy period, as well as a fact that the raw material had been obtained from the sources situated in the wider area of the city.

Based on available archaeological material, it has been concluded that several fabrics are dominant among functional ceramics and that several types occur more frequently than others. This diversity is more common than in the case of smaller sites. The reason for this is probably in the size of a settlement, intensity of life and a number of active potters. Black fired dishes, with red cross-section, stand out for their quantity. We are talking here about the pots, bowls, strainers and three-legged dishes made with very fragmented inclusions (Jelinčić 2009: T. 99–104). This



šavana (Jelinčić 2009: T. 90: 2; T. 91: 1; T. 102: 1; T. 105: 1–2). Zastupljeni su i jednostavno oblikovani lonci kratkog vrata latenskih tradicija (Jelinčić 2009: T. 89, 90: 1).

U Ščitarjevu je pronađena velika količina keramičke građe koju nije bilo moguće u potpunosti pregledati te ovaj mali uvid predstavlja manji dio materijala koji je izdvojen jer se činio kao specifičan za Ščitarjevo. Treba naglasiti kako Ščitarjevo, isto kao i Sisak i bilo koji drugi veći grad, zahtijeva izuzetnu i posebnu pažnju prilikom obrade i ove vrste materijala te se samo tako može dobiti objektivan prikaz tipova, struktura i tehnologije lokalno proizvedene uporabne keramike raznovrsne u svojoj tipologiji i izvedbi.

Na lokalitetu Šepkovčica (Karta 3) pronađen je keramički materijal koji je sličan keramičkom materijalu *Andautonia*, ali se od njega razlikuje po mekšim profilacijama. Tu su pronađeni lonci koji imaju izvijen obod, kratak cilindričan vrat i naglašeno rame (Jelinčić 2009: T. 79: 1–3; T. 84: 1–2). Ipak to rame nije naglašeno u onoj mjeri kao što je to slučaj u *Andautoniji* gdje je ta naglašenost ramena prisutna na loncima, tronošcima i zdjelama. Osim te male tipološke razlike, posude sa Šepkovčice se od posuda iz Ščitarjeva razlikuju i tehnološki i strukturno.

Na Šepkovčici su pronađeni lonci koji tipološki, ali ne i strukturalno pokazuju srodnost s loncima s lokaliteta Mala Mlaka - Starče (Jelinčić 2009: T. 78), što i ne iznenađuje s obzirom na veliku blizinu tih lokaliteta. Na Šepkovčici su pronađeni i tanjuri koji bi odgovarali tipu T2 (Jelinčić 2009: T. 76: 2), a koji se bojom pečenja razlikuju od takvih tanjura iz Ščitarjeva. Na lokalitetu Gornji Čehi pronađena je zdjela S profilacije (Jelinčić 2009: T. 72: 2) koja je tipološki, tehnološki i strukturalno srodna brojnim posudama takvog tipa u Ščitarjevu, a opet, radi se o lokalitetima koji su prostorno vrlo bliski.

Veliki gradovi, osobito Siscija, predstavljaju problem za sebe što se tiče ove vrste keramike. Pregledom građe i objavljenog materijala uočava se raznolikost lokalno izrađene keramike što je za očekivati s obzirom na broj stanovnika, većih potreba za uporabnom svakodnevnom keramikom i na veći broj lončara. Za dio uporabne keramike smatra se da je uvezena (Lolić 2003: 145), a sigurno je da keramički materijal ove vrste zaslužuje zaseban opširan osvrt ne samo zbog količine nalaza već i zbog različitih utjecaja i specifičnosti samog grada.

Uvidom u uporabnu keramiku iz Siska i to s više položaja: Žitni magazin (izvan antičkih gradskih zidina), (Jelinčić 2009: T. 121–132), Osnovna škola 22. lipanj (Jelinčić 2009: T. 119–120) Ante Starčevića 40 (Jelinčić 2009: T. 113–117) i Euroagram (Jelinčić 2009: T. 118) uočena je raznolikost materijala. Ono što je najuočljivije jest to kako ova građa na svakom lokalitetu predstavlja zasebnu cjelinu, osobito u strukturalnom pogledu. To se vidi na tipovima koji su prisutni u *Andautoniji* i Sisku, a nisu izrađeni od iste strukture što samo potvrđuje različito mjesto proizvodnje i iste tradicije. Među ranijim materijalom u Sisku jako je zastupljen

type of vessel has not been found in such a large quantity on other sites (Jelinčić 2009: T. 72: 1–2). Among the ceramics re-examined, the S-profiled vessels of the La Tène tradition, with a prominent shoulder, stand out (Jelinčić 2009: T. 96: 1; T. 97: 2–4, T. 98, 99, 100, 101, 103, 104, 105). Surface of the Ščitarjevo vessels is often comb-decorated (Jelinčić 2009: T. 90: 2; T. 91: 1; T. 102: 1; T. 105: 1–2). In addition, there are also the pots of a simple design, of La Tène tradition, featuring short neck (Jelinčić 2009: T. 89, 90: 1).

Large quantity of ceramic material was found at Ščitarjevo. Since it was not possible to examine all the material retrieved, herein we present only a small part of the material deemed specific for Ščitarjevo. It should be pointed out that Ščitarjevo, just like Sisak or any other bigger city, requires an exceptional care in processing of this kind of material, since this is the only way to objectively present the types, fabrics and technology of the locally produced functional ceramics, which are so heterogeneous in typology and workmanship.

At the Šepkovčica site (Map 3) ceramic material similar to the one in *Andautonia* was found, differing only in somewhat softer profiling. Pots with twisted rim, short cylindrical neck and prominent shoulder were retrieved at that particular site (Jelinčić 2009: T. 79: 1–3, T. 84: 1–2). However, the shoulder is not as pronounced as is the case with the pots of *Andautonia*, where the shoulders are pronounced on pots, three-legged dishes and bowls. In addition, the dishes from Šepkovčica differ from the ones found in Ščitarjevo both in typology and fabric.

The pots found at Šepkovčica bear typological, though not structural, kinship with the pots found at the Mala Mlaka - Starče site (Jelinčić 2009: T. 78), which does not come as a surprise given the close proximity of these sites. The plates corresponding to type T2 plates have also been found at Šepkovčica (Jelinčić 2009: T. 76: 2); these differ from the plates found at Ščitarjevo in colour of firing. An S-profiled bowl has been found at the Gornji Čehi site (Jelinčić 2009: T. 72: 2), it is typologically, technologically and in fabric similar to a number of dishes of this type found at Ščitarjevo; then again, these two sites are situated in close proximity.

Big cities, *Siscia* in particular, represent a unique problem when it comes to this type of ceramics. Re-examination of the archaeological material and published material shows the diversity of locally produced ceramics, which is not unexpected if one considers number of inhabitants, an increased demand for functional, every-day ceramics and increased number of potters. It is assumed that a part of functional ceramics had been imported (Lolić 2003: 145), and it is evident that this type of ceramic material deserves special attention, not only because of the amount, but also because of different influences and specifics of the city itself.

Examination of the functional ceramics found in the Sisak area at the following locations: Žitni magazin (outside the antiquity walls), (Jelinčić 2009: T. 121–132), The 22<sup>nd</sup> June Elementary school (Jelinčić 2009: T. 119–120), No. 40 Ante Starčević Road (Jelinčić 2009: T. 113–117) and Eurogram (Jelinčić 2009: T. 118), showed diversity of the material. The most prominent feature of this material is that the material





tip lonca koji je u ovom radu svrstan pod tip L1 (osobito na lokalitetu Sisak ulica A. Starčevića 40), (Jelinčić 2009: T. 114: 2–4, T. 115–116; T. 117: 1–2; T. 122: 1–3; T. 123: 1–2). To je tip lonca koji je u većoj ili manjoj mjeri zastupljen na svim lokalitetima Gornje, ali i Donje Panonije te predstavlja nasljedstvo latenske kulture.

U Sisku su ovi lonci mnogobrojni, javljaju se i kasnije, ali koliko je samo uvid u materijal mogao navesti na zaključak, u nešto manjoj mjeri. U slojevima kasne antike javlja se keramika koja u svojoj strukturi ima mnogo primjesa kvarca, tinjca i u nekim slučajevima vapnenca (Jelinčić 2009: T. 118: 2; T. 120: 2; T. 123: 3; T. 124: 2–4; T. 126: 1, 3–4; T. 128: 1; T. 131: 2; T. 132). Ovim uvidom zaključeno je kako je među ranijim materijalom u Sisku uporabno posuđe izrađivano uglavnom od gline s pijeskom te manje drugih primjesa, dok u kasnoj antici prevladava keramika s mnogo primjesa kvarca, a ponekad i vapnenca. Keramika s vapnencem često je raspucala i loše kvalitete (Jelinčić 2009: T. 132: 2). Bitno je naglasiti kako keramika s lokaliteta Sisak - Žitni magazin ima mnogo analogija s lokalitetom Sisak - Kovnica (Wiewegh 2001: 89–149).

U odnosu na keramiku iz Ščitarjeva, Varaždinskih Toplica i Ludbrega sisački materijal nema toliko češljasto ukrašene keramike. S obzirom na razvijenost Siscije, količinu i sveukupni karakter keramike koja je tamo pronađena, među uporabnom keramikom prisutna je velika količina rukom rađene keramike. Bilo bi zanimljivo detaljno pristupiti ovoj problematici od položaja do položaja u gradu i izvan njega te statistički obraditi keramiku rađenu rukom u odnosu na uporabnu keramiku rađenu na kolu te definirati njihove razlike u tipologiji i strukturi. Uvijek postoji i pitanje bogatstva pojedinih kupaca. Na selima je proizvodnja uporabne keramike za vlastite potrebe vrlo vjerojatna, međutim oni koji su živjeli u gradu morali su vjerojatno kupovati posuđe, a nisu svi mogli priuštiti kvalitetno i skuplje posuđe. Uporabna keramika izrađena na kolu sigurno je bila skuplja zbog same organizacije proizvodnje od one izrađene rukom koja nije bila konkurentna prethodnoj robi, a osobito onoj koja nije lokalno proizvedena. Također, rukom rađena keramika sigurno je jeftinija i kupovali su je oni manje imućni. Ako prihvatimo ove pretpostavke, ostaje nejasno zašto u Sisku postoji toliko velika količina rukom rađene uporabne keramike lokalne proizvodnje (barem prema pregledanom materijalu).

Sisak je bio nakon Dioklecijanove reforme središte Panonije Savije. Već i prije toga on je pored Petovija južno od Drave bio najveći i najvažniji grad, ekonomsko, trgovačko, proizvodno i administrativno središte. Siscija kao takva što se tiče sve pokretne arheološke građe zahtijeva poseban osvrt kao na posebnu problematiku. Iako su uvidom u uporabnu keramiku Siscije uočeni neki osnovni okviri, ova keramika kao i svaka druga, u ovako velikom centru zahtijeva zaseban pristup zbog toga što su sastav njenog stanovništva drugačiji tj. raznolikiji i po porijeklu i po imo-

found at each individual site represents a separate body of finds, particularly in the terms of fabric. It is visible on the types found in *Andautonia* and Sisak; they were made of different fabrics, which confirm that they were produced at different locations as a result of different traditions. The earlier material from Sisak contains quite a number of pots herein categorised as type L1 (especially at the Sisak site known as No. 40 Ante Starčević Street) (Jelinčić 2009: T. 114: 2–4, T. 115–116; T. 117: 1–2; T. 122: 1–3; T. 123: 1–2). More or less, this type of pot is present at all sites of Upper and Lower Pannonia, and it represents the heritage of the La Tène culture.

These pots are very common in the Sisak area; they occur at a later time as well, though not in great numbers. In the layers of the late antiquity one can find the ceramics containing a lot of quartz, mica, and in some cases limestone (Jelinčić 2009: T. 118: 2; T. 120: 2; T. 123: 3; T. 124: 2–4; T. 126: 1, 3–4; T. 128: 1; T. 131: 2; T. 132). This examination confirmed that the functional dishes from the earlier Sisak archaeological material were generally made of clay and sand, with some other inclusions, whereas the ceramics produced in the late antiquity were mostly made of the raw material containing quartz and limestone. The ceramics containing limestone were cracked and of poor quality (Jelinčić 2009: T. 132: 2). It is essential to point out that the ceramics from the Sisak - Žitni magazin site have a number of analogies with the one from the Sisak - Kovnica site (Wiewegh 2001: 89–149).

As compared to the ceramics from Ščitarjevo, Varaždinske Toplice and Ludbreg, the material from Sisak does not contain as many ceramics with comb-shaped ornamentation. Given the level of development of *Siscia*, as well as quantity and overall character of the ceramics found there, quite a large quantity of the hand-made ceramics is present among functional ceramics. It would be interesting to study this subject in detail, site by site, both within and outside the city, and process the hand-made ceramics using statistical methods, compare it with the functional ceramics produced on potter's wheel and define their differences in typology and fabric. There has always been a question of wealth of individual buyers. Production of functional ceramics for personal use is quite probable in a village; however, inhabitants of the cities were probably compelled to buy their dishes. Naturally, not everyone was in position to buy quality and expensive goods. Functional ceramics produced on the potter's wheel were more expensive than the ones made by hand. The latter was not competitive to the former, let alone the imported one. On the other hand, the hand-made ceramics were certainly much cheaper and thus more acceptable to those less fortunate. Even if we accept these assumptions, it still remains unclear why the locally produced and hand-made utility ceramics are so abundant in Sisak (at least according to the material that has been re-examined).

After the Diocletian reforms Sisak was the centre of Pannonia Savia. Even before the reforms, along with *Petovia*, Sisak was the biggest and the most important city south of the Drava river: Sisak was economic, commercial, industrial and administrative centre. When it comes to movable



vinskom stanju, ali je i gradska ekonomija drugačija nego u selima, vilama i manjim gradovima.

Zbog prostora omeđenog rijekama Dravom i Murom, za pretpostaviti je da Međimurje predstavlja zasebnu cjelinu unutar koje se može prepoznati jedna mikroregija. Na tom području, točnije na području Sv. Martina na Muri nalazio se *Halicanum*. Njegov status nije siguran, te je zbog toga nesigurna pripadnost tog područja teritoriju Sale ili Petovija (Tomičić 1979: 40–43; 1986: 120; Horvat et al. 2003: 160; Redó 2003: 193). Zbog nedostatka nalaza neka područja predstavljaju praznine i nepoznanice u smislu da se ne zna imenom koja su naselja tamo točno bila i čijem su području pripadala. U slučaju Komina zna se da je tamo bilo smješteno naselje *Pyrrri*, međutim ostaje nejasno prema podacima koja su nam donijela dosadašnja istraživanja koji je status tog naselja i čijem je teritoriju ono pripadalo. Također postoji dosta nejasnoća za područje južno od Kalnika i jugozapadno od Bilogore. Rekognosciranjem su uočeni antički lokaliteti, međutim njihova imena i teritorijalna pripadnost nisu jasni (Tkalčec et al. 2007: 5–25). Što se tiče granica teritorija Petovija i Andautonije također postoje neke nejasnoće. Navodi se kako je sjeverna granica Andautonijskog agera Medvednica (Nemeth-Ehrlich, Kušan Špalj 2003: 110), dok se za južnu granicu Petovijskog područja navodi dio od Rogateca i brda Ivanščice te kako na jugu graniči s područjem Andautonije (Horvat et al. 2003: 160). To ostavlja područje između Ivanščice i Medvednice nejasnim u smislu pripadnosti području nekog naselja. Nejasna je teritorijalna pripadnost lokaliteta uz Savu kod Brdovca. Oni se nalaze uz zapadnu granicu Andautonijskog agera, a istočno od Nevijodunumskog. Moguće je da pripada naselju u Ribnici gdje je ubicirana *Romula* (Galić, Radman-Livaja 2002: 243).

Uporabna keramika iz Topuskog (Jelinčić 2009: T. 106–112) predstavlja također zasebnu cjelinu. U Topuskom se javlja više različitih struktura, a karakteristično je da je sva površina hrapava i da se otire zajedno sa svojim sitnim primjesama. Javlja se veći tip lonca (Jelinčić 2009: T. 109: 1) koji je pronađen i u Sisku (Jelinčić 2009: T. 124: 1). Prisutni su različiti lonci, zdjele i poklopci različitih struktura. Iako strukturalno i tehnološki različita od keramike iz Siska i Ščitarjeva, keramički lonci pokazuju određene srodnosti s materijalom tih lokaliteta. Velikim brojem primjeraka zastupljene su zdjele čiji je obod uvučen prema unutra (Jelinčić 2009: T. 106–107).

U okolici Brdovca, kod Zaprešića nalazi se više antičkih lokaliteta. To su Drenje (Jelinčić 2009: T. 13: 140), Laduč (Jelinčić 2009: T. 141), Šibice (Jelinčić 2009: T. 142) i Zadругarsko (Jelinčić 2009: T. 143). Najviše keramike pronađeno je na lokalitetu Drenje, koje je i najintenzivnije istraživano (Drenje 1987). Što se tiče strukture grube keramike s Drenja prevladavaju dvije strukture (jedna je crna do siva i jako hrapava s puno primjesa, a druga je smečkastih tonova, hrapava s primjesama), a javljaju se u manjem broju i ne-

archaeological material, *Siscia* requires special consideration. Although some basic features have been observed during the examination of the *Siscia* functional ceramics, this particular ceramics found in such an important centre, as any other ceramics for that matter, require specific approach due to a specific character of the place, its inhabitants, who are different, both regarding their origin and their wealth. In addition, economy in the city differs from the one in the villages, small cities and hamlets.

Situated between the Drava river and the Mura river, Međimurje represents a separate unit, with a unique micro-region located within it. *Halicanum* was in that area, or more precisely in the area of Sv. Martin on Mura. Its status is still uncertain, as well as is the affiliation of that particular area to the territory of Sale or *Petovio* (Tomičić 1979: 40–43; 1986: 120; Horvat et al. 2003: 160; Redó 2003: 193). Due to lack of the finds, some areas are still blank and unknown, meaning that we still do not know the names of settlements or to which area they belonged. In the case of Komin, we only know that there was a place called *Pyrrri*; however, according to data available, its status and affiliation is still unclear. The same uncertainty applies to an area south of the Kalnik and south-west of the Bilogora. Recognisance detected some antiquity localities, although their names and territorial affiliation remain to be unclear (Tkalčec et al. 2007: 5–25). Some ambiguities also exist when it comes to the borders of the *Petovio* and *Andautonia* territories. It has been stated that the Medvednica mt. is the northern boundary of the *Andautonian* agger (Nemeth-Ehrlich, Kušan Špalj 2003: 110); it has also been stated that the southern border of the *Petovio* area is a section running from Rogatec to the Ivanščica Hill and that the *Petovio* area borders with the *Andautonia* area in the south (Horvat et al. 2003: 160). This leaves the area between the Ivanščica and the Medvednica undefined when we speak of its affiliation. Also unclear is a territorial affiliation of the sites situated along the Sava river near Brdovec. They are located next to the western border of the *Andautonia* agger and east of *Neviodunum* agger. It is possible that it belongs to Ribnica, where *Romula* was located (Galić, Radman-Livaja 2002: 243).

Functional ceramics from Topusko (Jelinčić 2009: T. 106–112) represents a separate unit as well. Several different fabrics can be found in Topusko, their common characteristic being that they are rough-surfaced and that they rub off together with the inclusions they contain. A larger type of pot has been found (Jelinčić 2009: T. 109: 1) similar to the one found in Sisak (Jelinčić 2009: T. 124: 1). Different pots, bowls and lids of various fabric have been found. Although different in fabric and technology from the ceramics from Sisak and Ščitarjevo, the ceramic pots show certain affiliation to the material found at these sites. Bowls with an inward turned rim are represented in great number (Jelinčić 2009: T. 106–107).

A number of antiquity sites can be found in Brdovec area near Zaprešić, such as Drenje (Jelinčić 2009: T. 133–140), Laduč (Jelinčić 2009: T. 141), Šibice (Jelinčić 2009: T. 142) and Zadругarsko (Jelinčić 2009: T. 143). The Drenje site, which was researched most extensively, contains the

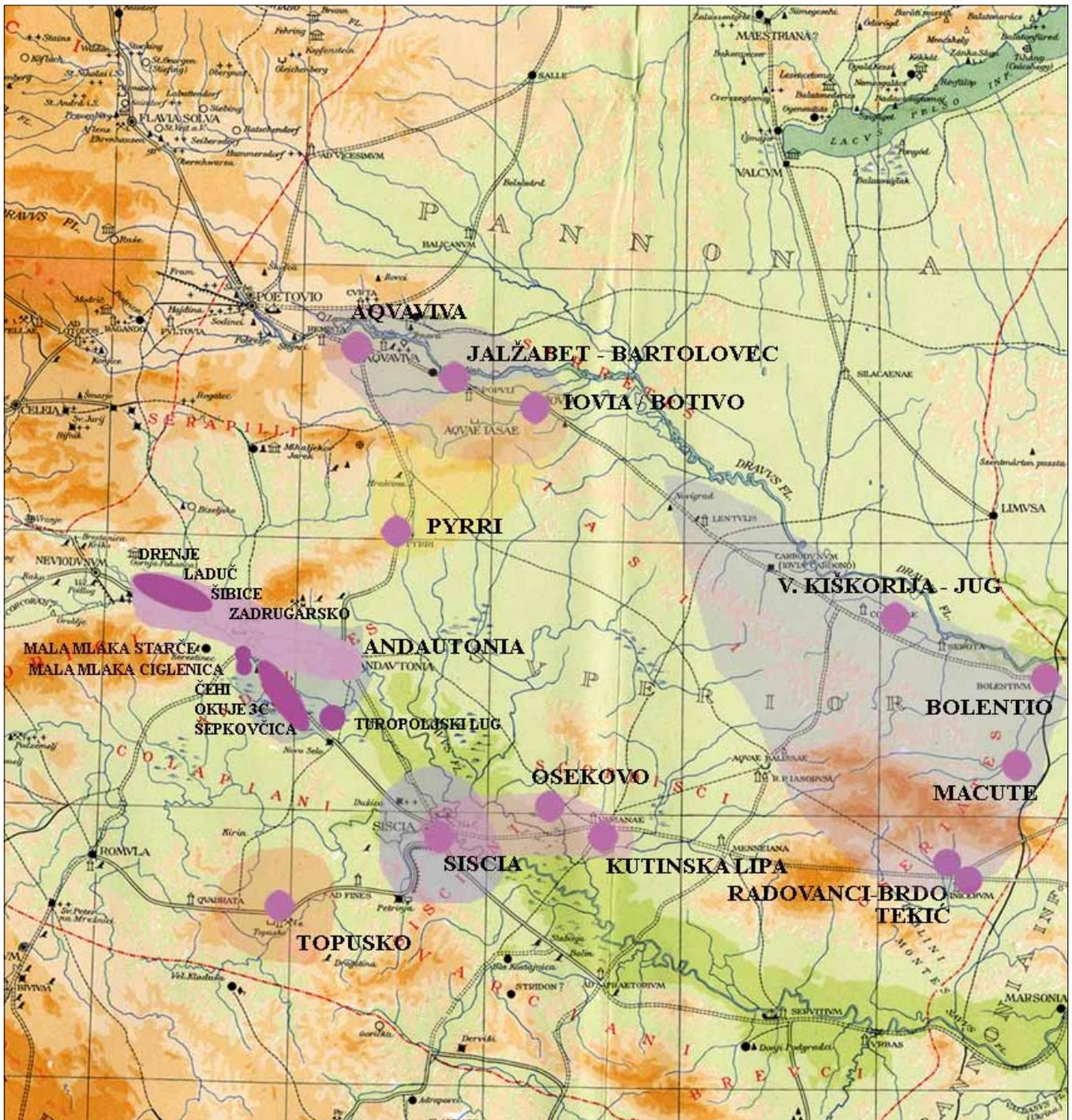

Karta 4 TIR foglio L 33 (isječak). Regije sa srodnim keramičkim materijalom  
 Map 4 TIR foglio (section). Regions with similar ceramic material

ke druge. Ono što je karakteristično za većinu keramike iz Drenja, bez obzira koja je struktura u pitanju, uvijek je bogato ukrašena metličastim ukrasom koji se primjenjuje na svim tipovima posuda. Pronađen je veliki broj tripesa i poklopaca, zatim lonaca, zdjela i tanjura. Što se tiče oblika, dio posuđa iz Drenja pokazuje srodnost s keramikom sa šireg područja Andautonije.

Ipak, u Drenju nedostaju oni jako karakteristični S oblikovani lonci, tronošci, zdjele i cjediljke izrađene od crne keramike, ali i općenito keramike takve strukture. Da-

largest quantity of ceramics (Drenje 1987). When it comes to the fabric of the coarse ceramics from Drenje, two types of fabric prevail (one being black to grey with plenty of inclusions and the other being brownish, coarse and with inclusions), although some other types may also be found. Regardless of the fabric, the most prominent characteristic of the greater part of the ceramics from Drenje is their decoration achieved by use of a brush, which is applied on all types of dishes: quite a few tripes and lids were retrieved, as well as pots, bowls and plates: as for their shape, a part of the dishes from Drenje show some similarity to the cera-



kle, tipološki Drenje i Ščitarjevo imaju srodan materijal, u određenoj mjeri, ali ne u potpunosti. Keramika sa Drenja, najbližnja je keramici sa lokaliteta Laduča (Jelinčić 2009: T. 141), koji je Drenju najbliži. S Laduča ima nešto manje keramike i ona je dosta usitnjena te ju je teško uspoređivati, ali je jasno kako su na Laduču prisutne one dvije najzastupljenije strukture s Drenja. Lokalitet Šibice (Jelinčić 2009: T. 142) nešto je udaljeniji i pokazuje nešto manje srodnosti s prethodna dva lokaliteta i sa Zadrugarskim, ali ipak pripada ovoj svojevrsnoj mikro regiji. S lokaliteta Zadrugarsko (Jelinčić 2009: T. 143) ima malo ulomaka keramike i ona je dosta fragmentirana. Prisutne su iste strukture keramike kao i na Drenju i Laduču, tipovi i ukrasi. Srodnost keramike s lokaliteta u okolici Brdovca ne iznenađuje s obzirom da se radi o malom području i lokalitetima koji su blizu jedni drugih.

Lokalitet Ciglenice - Osekovo (Bobovec 2003; 2008; Jelinčić 2008: T. 144–151) poznat je još iz 19. stoljeća, a krajem 20. i početkom ovog stoljeća istraživao je u više navrata. Zbog više istraživanja, s ovog lokaliteta iskopana je znatna količina arheološkog materijala od kojih veći dio čini raznovrsna keramika. Prethodnim pregledom keramike u Sisku uočeno je prisustvo dvaju struktura koje su zastupljene u velikoj količini, a pregledom keramike s lokaliteta Ciglenica - Osekovo uočeno je da su takve strukture zastupljene i na njemu. Riječ je o smeđe pečenoj keramici s puno tinjca, tanjih stijenki koja je tvrda i dobro je pečena (Jelinčić 2009: Sisak: T. 118: 2; T. 120: 2; T. 123: 3; T. 131: 1; Ciglenice - Osekovo: T. 144; T. 145; T. 146: 1–5; T. 151: 6) i neujednačeno pečenoj keramici pjeskovite strukture bez krupnih primjesa (Jelinčić 2009: Sisak: T. 118: 4; T. 119: 3, 4; T. 120: 1; T. 121: 3/4; T. 124: 1; T. 131: 3; Ciglenice - Osekovo: T. 146: 6–7; T. 147; T. 148: 1–3).

Ova keramika srodna je i tipološki. Na Ciglenicama prisutna je i keramika drugih struktura, ali u manjoj mjeri. Na lokalitetu je pronađen velik broj ulomaka tanjura i zdjela različite strukture od kojih bi jedan dio mogao biti i lokalne proizvodnje (Bobovec 2008: 35. 5852, 5857; Jelinčić 2009: T. 150: 2, 4, 5, 8, 9).

Uporabna keramika s lokaliteta Kutinska lipa (Bobovec 2007) srodna je keramici iz Ciglenica - Osekovo, a time i uporabnoj keramici iz Siska. Istraživanja na ovom lokalitetu tek su započela pa s njega nema mnogo materijala za usporedbu. Kako se radi o urbaniziranoj zoni, lokalitet je pa tako i materijal dosta oštećen, a keramika usitnjena. Prevladava keramika pjeskovite strukture (Jelinčić 2009: T. 1–7), a u nešto manjoj mjeri ima one s tinjcem (Jelinčić 2009: T. 152: 8; T. 153).

Tipološki ovaj je materijal također srodan keramici s Ciglenica - Osekovo i Siska. Zanimljiva je sličnost keramike koja se javlja na ova dva zadnja lokaliteta s keramikom iz Siska. Obično su lokaliteti koji pokazuju takvu sličnost i srodnost materijala dosta bliži. Razlog tome je vjerojatno to što je Sisak bio jak proizvodni centar te je kao takav mo-

mics from the wider area of *Andautonia*.

However, Drenje is lacking in those characteristic S-shaped pots, tripods, bowls and strainers made in black ceramics, as well as in ceramics of such fabric in general. Therefore, Drenje and Ščitarjevo share typologically similar material to a certain degree, though not entirely. The ceramics from Drenje bears the closest resemblance to the one from the Laduč site (Jelinčić 2009: T. 141), as these two locations are situated in the closest vicinity. Laduč has not yielded that much ceramics, and when it did it came up rather fragmented and thus difficult to compare to other finds, though it is clear that both fabrics so frequent at Drenje are represented here as well. The Šibice site (Jelinčić 2009: T. 142) is somewhat farther away and it shows less similarity to the former two sites, or to Zadrugarsko for that matter, but it still belongs to this distinctive micro-region. Only few fragments of ceramics have been retrieved at the Zadrugarsko site (Jelinčić 2009: T. 143), where the same fabrics, types and decorations are present as in Drenje and Laduč. Similarity of the ceramics found in the Brdovec area does not come as a surprise, given the size of the area and the proximity of the sites.

The Ciglenice - Osekovo site (Bobovec 2003; 2008; Jelinčić 2008: T. 144–151) has been known ever since the 19<sup>th</sup> century; it has been researched on several occasions in 20<sup>th</sup> century and at the beginning of the 21<sup>st</sup> century. As a result, a large quantity of archaeological material has been excavated, the majority being various ceramics. Preliminary examination of the ceramics found in Sisak revealed the presence of two main fabrics, which were also discovered in the ceramics from the Ciglenice - Osekovo site. One is hard; well fired, brown ceramics, containing large quantities of mica, with thin walls (Jelinčić 2009: Sisak: T. 118: 2; 120: 2; 123: 3; 131:1; Ciglenice - Osekovo: T. 144; 145; 146: 1–5; 151: 6) and another is unevenly fired ceramics of sandy fabric containing no coarse inclusions (Jelinčić 2009: Sisak: T. 118:4; 119: 3, 4; 120: 1; 121: 3/4; 124: 1; 131: 3; Ciglenice - Osekovo: T. 146: 6–7; 147, 148: 1–3).

These ceramics are typologically analogous as well. At Ciglenice, the ceramics of other fabric are also present, though to a lesser extent. A number of fragments of plates and bowls of different fabric has been found at the site, a certain portion of which could be locally produced (Bobovec 2008, 35. 5852, 5857; Jelinčić 2009: T. 150: 2, 4, 5, 8, 9).

Functional ceramics from the Kutinska Lipa site (Bobovec 2007) are analogous to the ceramics from the Ciglenice - Osekovo site and consequently to the functional ceramics from Sisak. The research at this site has only begun so that we do not have enough material for comparison. As this is an urban zone, the site and the material is quite damaged and the ceramics are fragmented. The ceramics are of a sandy fabric (Jelinčić 2009: T. 1–7), although there are some pieces containing mica (Jelinčić 2009: T. 152: 8; 153).

Typologically, this material is also related to the ceramics from Ciglenice - Osekovo and Sisak. It is interesting to note the similarity of the ceramics from these two sites and the ceramics from Sisak. Usually, this high level of similarity indicates proximity of the sites. The reason for this probably lies in the fact that Sisak was an important production



gao podmiriti nešto šire tržište i uporabnom keramikom.

Keramika pjeskovite strukture koja je zastupljena u Sisku, Ciglenici - Osekovo i Kutinskoj Lipi, srodna je keramici koja se susreće na Virovitičkom području u svojoj strukturi, a s malim odmacima i u oblicima. Takve keramike, barem za sada, nema sjeverno od Siska i u okolici Varaždina.

Usporedbom keramike s 22 antička lokaliteta primjećuju su neke sličnosti kako tipološkog i tehnološkog, tako i strukturalnog karaktera. Također jasnije su i razlike između pojedinih lokaliteta i područja. Postavljanje jasnih i čvrstih granica u ovom trenutku nije moguće, a pretpostavljam da ih se čvrsto nikada neće ni moći postaviti. Ovdje se prilaže karta (karta 4) na kojoj se vide područja koja imaju keramiku zajedničkih obilježja. Na njoj se vidi kako se i neka područja koja čine zasebne cjeline isprepliću, a to je zbog toga što je barem dio njihovog materijala srodan. Novim istraživanjima, te detaljnom obradom keramike svakog lokaliteta moći će se definirati nova područja i nove granice.

centre capable of supplying the functional ceramics to the markets in the wider area.

When it comes to the fabric, the ceramics of the sandy fabric found at Sisak, Ciglenice - Osekovo and Kutinska Lipa are related to the ceramics found in the Virovitica area, although there are some deviations when it comes to design and shapes. This type of ceramics cannot be found north of Sisak and in the vicinity of Varaždin, at least for the time being.

Comparing the ceramics from 22 antiquity sites, one can discern certain typological and technological similarities, as well as some similarities when it comes to fabrics. Also, one can clearly see the differences between individual sites and areas. At this point we are not able to draw distinct boundaries and I sincerely doubt it will be possible to draw any such firm boundaries in future either. Map 4 shows the areas containing the ceramics featuring the same characteristics. This map also illustrates how some of the areas that form separate units overlap due to similarity of the ceramics, or at least a part whereof, found in respective areas. Future research and further processing of the ceramics from each of these sites will make it possible to define new areas and new boundaries.

## 3.6.

### Keramički utezi i pršljeni *Ceramic loom weights and whorls*

Pronalazak keramičkih utega i pršljena na Kiškoriiji upućuju na izradu tkanina unutar sela, vjerojatno za potrebe stanovništva sela i to unutar samih domaćinstava (sl. 165–167).

Proizvodnja tkanine ima više proizvodnih faza (Wild 1999: 29/30, T. 1), a neke od njih mogu se prepoznati na Kiškoriiji. Među arheobotaničkim nalazima nisu pronađeni ostaci lana, a među arheozoološkim ostacima pronađeni su ostaci kostiju ovaca/koza. Zbog toga ovdje možemo govoriti pouzdano samo o izradi tkanina od vune, ali ne i od lana. Pronađeno je još nekoliko nalaza koji omogućavaju diskusiju o proizvodnji tkanina na lokalitetu: brončano zvonce (T. 19: 11) sa sitne preživače i željezna igla (T. 12: 16). Pronađena je i češljagija (T. 5: 10a–b) za čišćenje stoke što nesumnjivo govori o postojanju stoke u selu, ali ne i nužno o korištenju vune i proizvodnji tkanina. Brončano zvonce je pripadalo sitnoj stoci, ali ne možemo ga vezati isključivo za ovce, moglo je biti namijenjeno kozi. Igla se mogla koristiti i u kožarskom obrtu (vidi poglavlje 4.3). Od svih spomenutih nalaza, jedino su pršljeni i utezi sigurni pokazatelj izrade tkanina.

Arheozoološka analiza potvrdila je prisutnost sitnih preživača na lokalitetu, ali zbog loše očuvanosti kostiju nije bilo moguće utvrditi je li riječ o ovcama i kozama (vidi poglavlje 5.1). Ako pretpostavimo prisutnost ovaca njihova je korist bila višestruka: meso, mlijeko, vuna, koža (vidi poglavlje 5.3, tablica 10). Vuna se mogla koristiti za izradu tkanina, ali i u medicinske svrhe (Mantovanelli 2012: 633–640). Wild navodi kako su na selima neke ovce vjerojatno imale smeđu ili sivu vunu, a križanjem se došlo do ovaca sa čisto bijelom vunom čime dolazi do potrebe bojanja, koje se vršilo i u ruralnim krajevima, a ne samo u specijaliziranim radionicama u gradovima (Wild 1999: 33). Columella (XII, 3,6,) govori o izradi tekstila na rustičnim vilama kao o sasvim logičnom dijelu svakodnevnog života u okviru gospodarske isplativosti (Wild 1999: 29) što u potpunosti ima smisla s obzirom na ideju samodostatnosti rimskih vila. Kiškoriija nije rustična vila, već selo, ali se na njemu moralo proizvesti što više raznovrsne robe kako bi se stanovnici unutar zajednice mogli osigurati sve potrebštine.

U zatvorenoj cjelini datiranoj u 5. st. (SJ 1363/1364)

Ceramic weights and whorls found at Kiškoriija would suggest that the textile production was present in the village, probably for personal needs of the local population and individual households (fig. 165–167).

Textile production is divided into several stages (Wild 1999: 29/30, T. 1) and some of them may be identified at Kiškoriija. The archaeobotanical finds do not contain traces of flax, whereas archaeozoological finds contain traces of sheep/goat bones. Therefore, in this case we can only speak with certainty about the production of woollen textile, and not about the one made of flax. Few finds, such as bronze bell (Pl. 19: 11) for small stock and an iron needle (Pl. 12: 16), do suggest that the textile production was present at this particular site. A curry-comb for grooming the cattle (Pl. 5: 10a–b) was also found, which would suggest that there was some cattle in the village, but not necessarily that the wool was used in textile production. Bronze bell was used on small-stock, but we cannot associate it exclusively with the sheep, because it could have been used for the goats as well. The needle could have been used for tailoring leather products (see chapter 4.3). The only positive finds suggesting the existence of textile production at this site are the weights and whorls.

The archaeozoological analysis confirmed the presence of small-stock at the site, though to a poorly preserved bones it was not possible to ascertain whether these were sheep or goats (see chapter 5.1). If we assume the presence of sheep, then we might say that they were useful for several reasons: meat, milk, wool, leather (see chapter 5.3; Table 10). Wool could have been used in textile production and also for medical purposes (Mantovanelli 2012: 633–640). Wild states that the sheep in the villages could have had brown or grey wool, and that the white wool was the result of cross-breeding, thus making it essential to dye the wool, which was performed in rural areas, not only in specialised workshops in the cities (Wild 1999: 33). Columella (XII, 3,6) speaks of the textile production in rustic villas as a common and logical part of everyday life in terms of economic profitability (Wild 1999: 29), which makes sense given the idea of the Roman villas' self-sufficiency. Kiškoriija is not a rustic villa, but a village, which, nevertheless, had to produce a variety of goods in order to ensure the sustainable life for the entire community.

In an enclosed unit dated to the 5<sup>th</sup> century (SU



pronađena su dva velika utega za tkalački stan, kat. br. 3–4 (T. 19: 8–9). Veći je u obliku krnjeg stošca, (T. 19: 8), a manji u obliku krnje piramide (T. 19: 9). Uteg oblika krnje piramide ima analogija datiranih od 2. do 3. st. u selu Schwennenz u Njemačkoj (Fiedler, Schultze 2005: Abb. 19: 13). U Sisku su piramidalni utezi datirani od 1. do 4. st. (Bačani et al. 2012: 160–161).

Manji pršljen (T. 15: 5) ima analogiju na istom lokalitetu u Njemačkoj, u rimskom selu između 2. i 3. st. (Schwennenz), (Fiedler, Schultze 2005: Abb. 19: 6). Ručno predenje niti bilo je zanimanje koje se veže uz žene, a obavljalo se tijekom cijele godine uz druge aktivnosti u kućanstvu (Wild 1999: 33).

Rimljani su poznavali tri vrste tkalačkih stanova: tkalački stan s utezima, tkalački stan s dvije grede i vodoravni tkalački stan (Wild 1987: 459; <http://www.unc.edu/~klaxton/kathy.html>). Prevladava mišljenje kako je izrada tkanina u domaćinstvima bila uglavnom ženska uloga, međutim postoje grafiti iz Pompeja koji svjedoče kako su ponekad i muškarci tkali (Moeller 1969: 562).

Utezi iz cjeline datirane u 5. st. (SJ 1363/1364) bili su dio tkalačkog stana (T. 19: 8–9). Ovakva vrsta tkalačkog stana poznata je od prapovijesti, a utezi su služili da nategnu

1363/1364) two large loom weights, Cat. Nos. 3/4 have been found (Pl. 19: 8–9). The larger has a shape of a truncated cone (Pl. 19: 8), whereas the smaller one looks more like a truncated pyramid (Pl. 19: 9). The latter one has the analogies dated back to the 2<sup>nd</sup> and 3<sup>rd</sup> century in the village of Schwennenz, Germany (Fiedler, Schultze 2005: Abb. 19: 13). Similar weights found in Sisak are dated back to the 1st to 4th century (Bačani et al. 2012: 160–161).

The smaller whorl (Pl. 15: 5) has the analogy at the same site in Germany, in a Roman village from the 2<sup>nd</sup> and 3<sup>rd</sup> century (Schwennenz), (Fiedler, Schultze 2005: Abb. 19: 6). Thread spinning was associated with female population of the time and it took place during the entire year, along with other chores (Wild 1999: 33).

The Romans knew three types of looms; looms with weights, looms with two beams and horizontal loom (Wild 1987, 459; <http://www.unc.edu/~klaxton/kathy.html>). It is a prevailing opinion that women only were involved in textile production, however there are some Pompeii graffiti testifying that men also were involved in spinning (Moeller 1969: 562).

The weights from the unit dated back to the 5<sup>th</sup> century (SU 1363/1364) where part of a loom (Pl. 19: 8–9). This type of loom has been known ever since prehistoric times, and



Sl. 165 Utezi i pršljeni  
Fig. 165 Loom weights and whorls

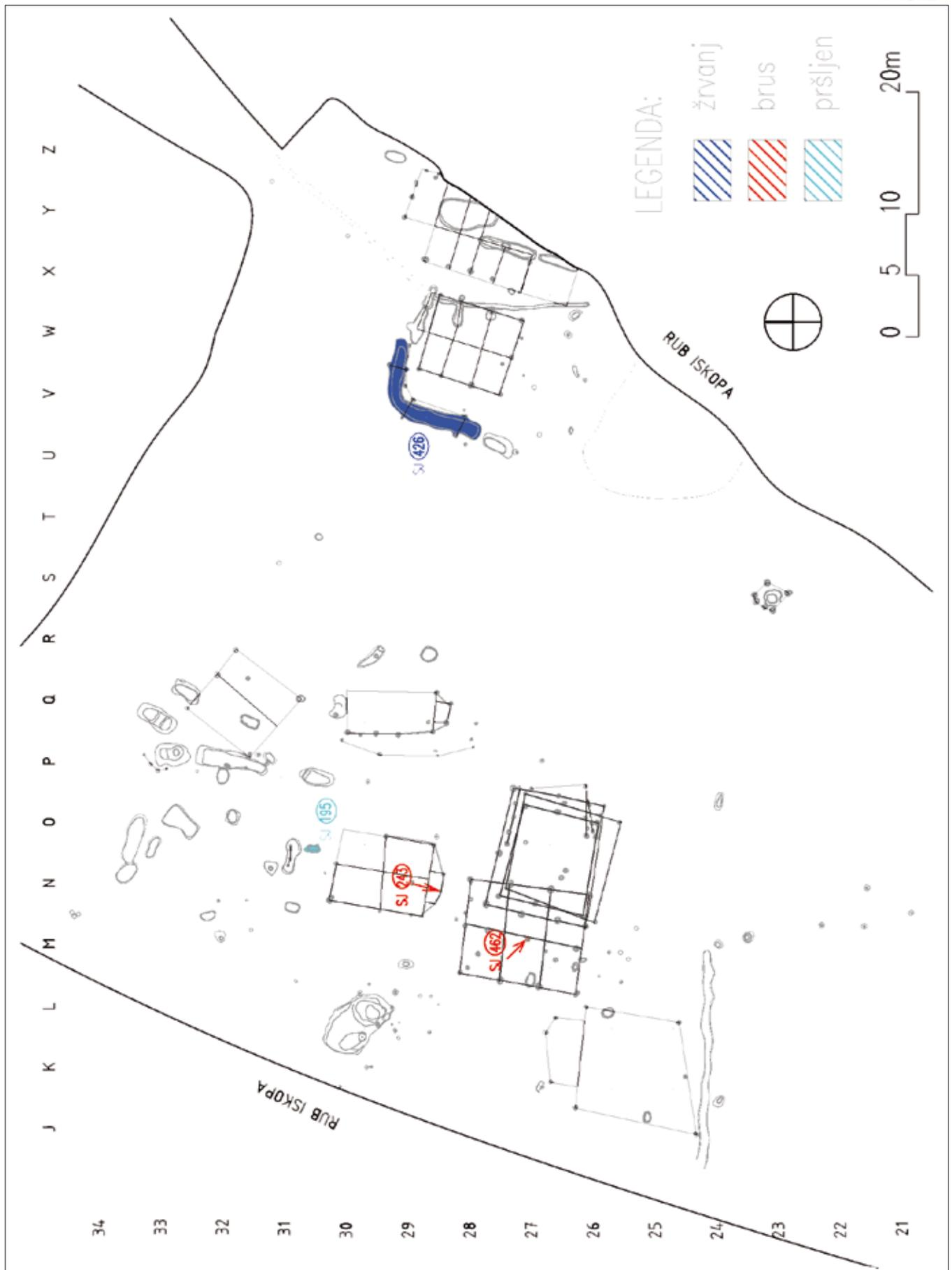

Sl. 166 Distribucija nalaza žrvnjeva, brusova, pršljenova  
 Fig. 166 Distribution of whetstones, grindstones and whorls



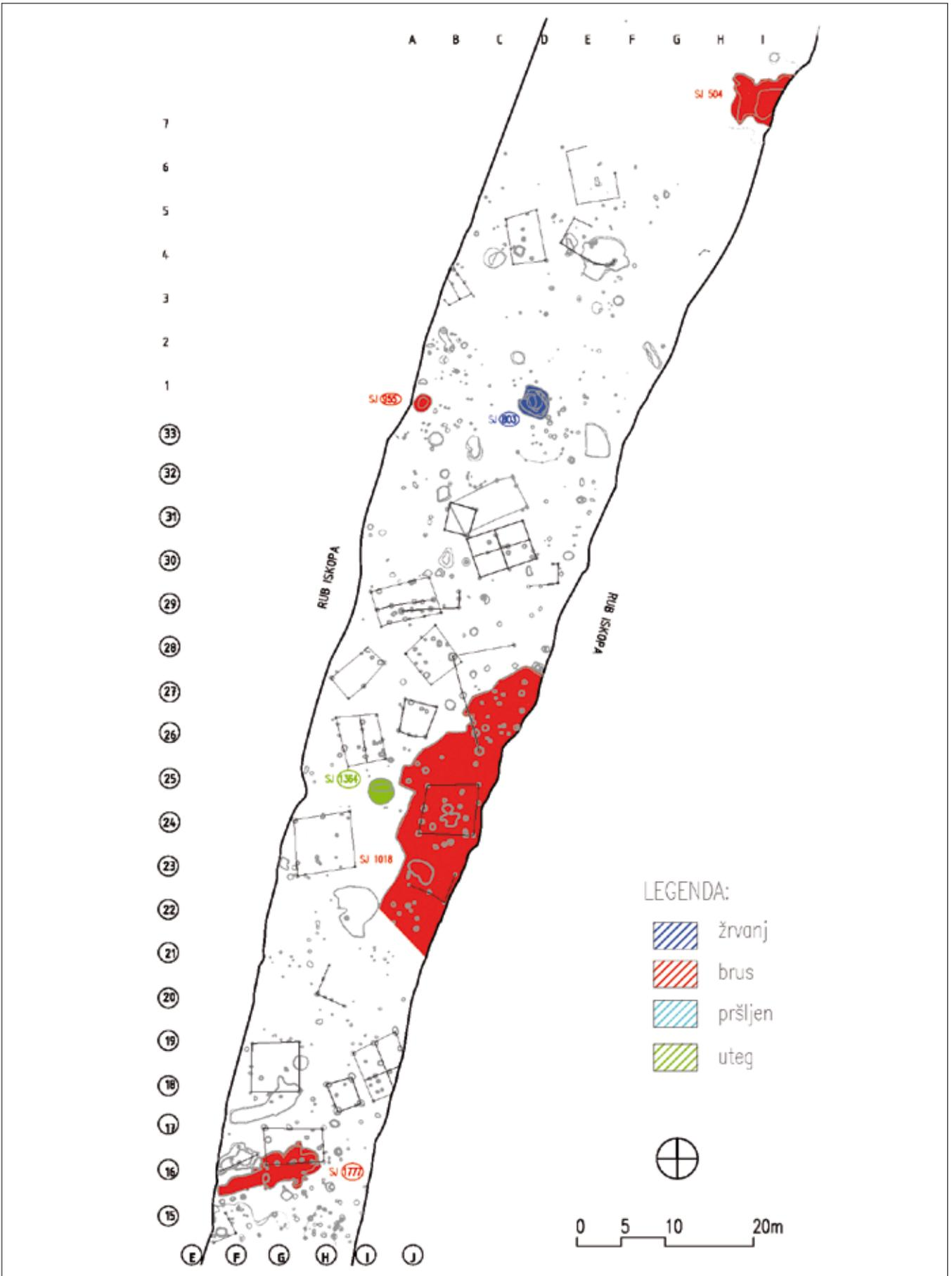

Sl. 167 Distribucija žrvnja, brusova, pršljena i utega  
 Fig. 167 Distribution of whetstones, grindstones; whorls and weights

184



niti i drže ih ravnima. Oni su uglavnom izduljenog oblika kako bi ih moglo što više stati jedan do drugog zbog velikog broja niti, a svakako su trebali biti teški kako bi dobro izvršili svoju ulogu.

Pršljeni za ručno pređenje pronađeni su u SJ 368 (srednjovjekovni objekt) i SJ 194, različite su veličine i težine što prema nekim analizama i eksperimentalnoj arheologiji može govoriti o pređenju niti biljnog i životinjskog porijekla (Sekelj Ivančan 2010a: 387). Prema tome, veći bi pršljen (T. 14: 2) služio za pređenje niti biljnog porijekla (lan) 1, a manji pršljen, (T. 15: 5) mogao bi služiti za pređenje niti životinjskog porijekla (vuna). Kao što je napomenuto, tragovi lana nisu pronađeni na lokalitetu, no važno je ovdje napomenuti kako je radi kiselosti tla organski materijal loše očuvan, pa je lan radi toga možda i uništen.

Usprkos postojanju tekstilne industrije u rimskom razdoblju, kućna izrada tkanina za obiteljske i osobne potrebe nije bila potisnuta tijekom cijele antike. Izgled raznih tkalačkih stanova i prikazi žena s preslicom poznati su s freski, reljefa, nadgrobnih spomenika i posuda (Crowfoot 1936/1937: 38; Broudy 1993: 47; Sperti 2012: 513–522). Utezi za tkalački stan kao i pršljeni za ručno pređenje često su zanemareni arheološki nalazi koji nam ipak donose podatke o svakodnevnici nekog razdoblja.

the weights were used to tighten and align the threads; they were generally elongated in shape and quite heavy so that they could be fitted alongside each other in order to accommodate and tighten a great number of threads.

Whorls for hand-spinning were found at the SU 368 (medieval structure) and SU 194; they are different in size and weight, which, according to some analyses and experimental archaeology, would suggest that both animal and vegetal threads were used (Sekelj Ivančan 2010a: 387). Therefore, the larger whorl (Pl. 14: 2) could have been used for the threads of vegetal origin (flax), 1, whereas the smaller one (Pl. 15: 5) was presumably used for threads of animal origin (wool). As mentioned hereinabove, flax traces have not been found at the site, but still it has to be pointed out that organic material was poorly preserved due to acidity of soil so that flax could have been destroyed.

In spite of the textile industry in the Roman era, homemade textile manufacture for personal and family use was never extinct during the entire antiquity period. The appearance of various looms and depictions of women holding a distaff are often seen on frescoes, reliefs, tombstones and dishes (Crowfoot 1936/1937: 38; Broudy 1993: 47; Sperti 2012: 513–522). Weights and whorls for looms are often neglected archaeological finds, though they are so valuable in supplying us data about the everyday life in certain historical period.

1 Organski ostaci na lokalitetu su radi kiselosti jako loše očuvani te ostaci lana možda radi toga nisu očuvani. Radi toga se ne može potvrditi kakve su se niti tkale na ovom pršljenju.

1 Organic remnants at the site were poorly preserved due to acidity of soil, this being the reason for absence of flax. That is why it was impossible to confirm what kind of thread was spun on this whorl.



## 3.7.

### Građevinski materijal *Building material*

Već sam pogled na kartu lokaliteta ili zračni snimak istraženog lokaliteta, (sl. 3/4, 168–172) arheolozima daje do znanja kako su se u ovom selu nalazile kolibe i poluukopani objekti građeni od drveta i sušene gline, a da su im krovovi bili prekriveni slamom. Nedostatak rimskih opeka (pronađen je samo 1 ulomak: sl. 173), kamena i žbuke, mnoštvo ostataka drvenih stupova te velika količina lijepa to potvrđuju.

Pored mnoštva amorfnih ulomaka lijepa, izdvajaju se i oni koji imaju ostatke negativa šiblja i dasaka različite veličine, a koji su zajedno tvorili zidne i pregradne konstrukcije različitih objekata (T. 6–7; T. 9: 8–9; T. 13; T. 21: 15a–15b; T. 27: 10–11).

Na temelju takvih ostataka jasno je kako su objekti bili građeni kombinacijom drvenih dasaka, što ravnih što obrađenih, i granja većih i manjih dimenzija u kombinaciji s blatom (sl. 134).

A mere glance at the site map or an aerial shot of the examined site (fig. 3/4, 168–172) will prove sufficient to an archaeologist to see that the area contained huts and pit houses built of wood and dried clay, with roofs covered with straw. Absence of Roman bricks (only one fragment was retrieved, fig. 173), stone and plaster, and numerous remnants of wooden posts and large quantity of daub will only confirm this impression.

Along with large quantity of amorphous fragments of daub, there are also some that exhibit negatives of wickerwork and planks of different sizes, suggesting that they all formed walls and partitions of different structures (Pl. 6–7; Pl. 9: 8–9; Pl. 13; Pl. 21: 15a–15b; Pl. 27: 10–11).

Based on these remnants one can see that the structures were built using combination of wooden boards, straight or processed, smaller and larger branches and mud (fig. 134).

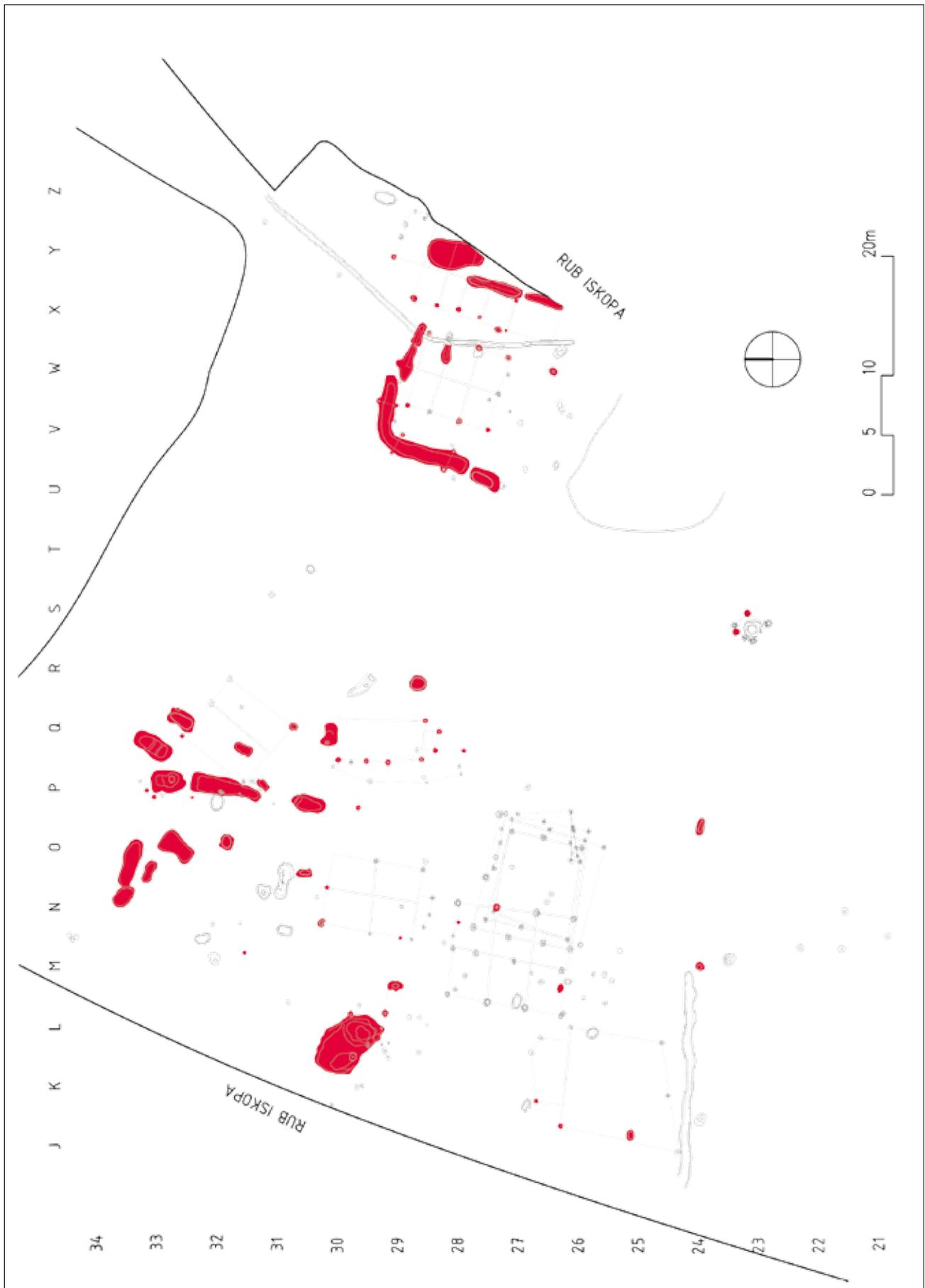

Sl. 168 Nalazi lijepa  
 Fig. 168 Finds of daub

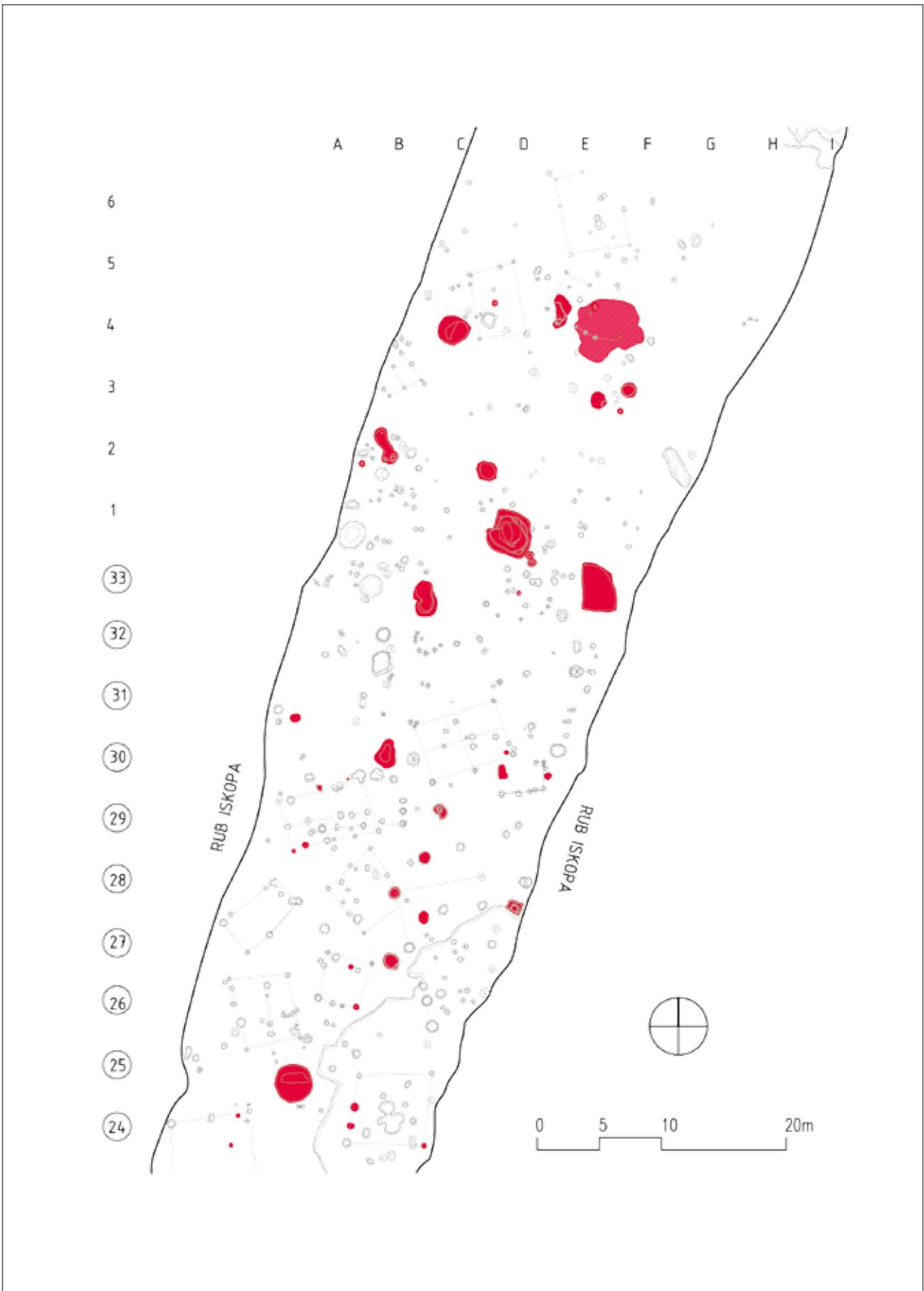

Sl. 169 Položaj nalaza lijepa  
Fig. 169 Positions where daub was found



Sl. 170 Položaj nalaza lijepa

Fig. 170 Position where daub was found



Sl. 171 Zračni snimak lokaliteta. Pogled na središnji-najniži dio s dva bunara. Na sjeveru se vidi lokalitet Virovitica Kiškorija sjever – kasnolatensko naselje.

Fig. 171 Aerial photography of the site. View of the central part with two wells. The Virovitica Kiškorija North site – the Late La Tène settlement is seen in the north





Sl. 172 Zračni snimak južnog dijela lokaliteta  
Fig. 172 Aerial shot of the southern part of the site

## Katalog keramičkih predmeta (posuđe, utezi, pršljeni i lijep) Catalogue of ceramic items (dishes, loom weights, whorls and daub)

### KERAMIČKO POSUĐE<sup>1</sup> – KATALOG

#### Kompleks 1

##### SJ 004

1. Ulomci lonca s dvije drške. Obod je blago zaobljen, izvijen prema van sa zaobljenim rubom. Rame je zaobljeno. Ručka počinje na obodu i polukružno se izdiže iznad oboda. U presjeku je blago profilirana. Lonac je bio izrađen od pjeskovite strukture s loše očuvanim premazom (T. 1: 1).

*dR* – 16 cm; *dN* – 15,8 cm; *dH* – 2,8 x 1,4 cm; *WT* – 0,5 cm; *St* – zaglađena; *CS* – CF neujednačena smeđa (5YR5/2–7,5YR6/4); SJ 004; □ O 32; S – VI; N – 44; T – L5; Fa – VKJ 2

2. Ulomci poklopca. Drška poklopca nije sačuvana. Unutrašnjost je zaglađena, a boja pečenja je neujednačena. Stijenke su kose i blago utisnute prema unutra (T. 1: 2).

*dR* – 20 cm; *hV* – sačuvan u visini od 6,4 cm; *WT* – 0,7 cm; *St* – zaglađena; *CS* – vani: svijetlo smeđa boja (7,5YR6/4), unutra: tamno smeđa (7,5YR4/2); *CF* – crvena (7,5YR5/6) do svijetlo siva (7,5YR7/1); SJ 004; □ O 32; S – VI; N – 44; T – P1; Fa – VKJ 2

3. Ulomak zdjele tere sigilate, vjerojatno proizvedene u Rheinzabernu. Na površini se nalazi glatki sjajni premaz (T. 1: 3).

*WT* – 0,8 cm; *St* – zaglađena; *CS* – crvena (10R4/8); *CF* – crvena (10R5/4); SJ 004; □ O 32; S – VI; N – 44; Tip – ?; Fa – pročišćena, s primjesama jedva vidljivim pod uvećanjem

##### SJ 007/008

4. Ulomak lonca izvijenog i zaobljenog oboda. Vrat je jedva naglašen, a rame je zaobljeno. Nema tragova

### CERAMIC DISHES<sup>1</sup> – CATALOGUE

#### Complex 1

##### SU 004

1 Fragments of a pot with two handles. The rim is slightly rounded, protruding outward and with a rounded edge. Rounded shoulder. The handle starts at the rim and raises above it. Slightly profiled cross-section. The pot is made of sandy fabric with poorly preserved slip (Pl. 1: 1).

*dR* – 16 cm; *dN* – 15.8 cm; *dH* – 2.8 x 1.4 cm; *WT* – 0.5 cm; *S* – smoothed; *CS* – CF – uneven brown (5YR5/2–7.5YR6/4); SU 004, □ O 32, A – VI; F – 44; T – L5; Fa – VKJ 2

2 Fragments of a lid. The handle of the lid is not preserved. Smoothed on the inside, uneven firing colour. Slanting walls, slightly incused (Pl. 1: 2).

*dR* – 20 cm; *hV* – preserved height 6.4 cm; *WT* – 0.7 cm; *S* – smoothed; *CS* – outer surface: light brown (7.5YR6/4), inner surface: dark brown (7.5YR4/2); *CF* – red (7.5YR5/6) to gray (7.5YR7/1); SU 004, □ O 32; A – VI; F – 44; T – P1; Fa – VKJ 2

3 Fragment of a *terra sigillata* bowl, probably produced in Rheinzabern. Smooth glossy slip on the surface (Pl. 1: 3).

*WT* – 0.8 cm; *S* – smoothed; *CS* – red (10R4/8); *CF* – red (10R5/4); SU 004, □ O 32, A – VI, F – 44; T – ?; Fa – purified, with inclusions barely visible under magnifier

##### SU 007/008

4 Fragment of a pot with a protruding rounded rim. Neck slightly emphasized rounded shoulder. No traces of slip, uneven firing colour (Pl. 1: 4).

*dR* – 15 cm; *dN* – 14.2 cm; *WT* – 0.6 cm; *S* – slightly coar-

1 Kratice korištene u katalogu keramičkih predmeta: *dR* – promjer oboda; *dN* – promjer vrata; *dV* – promjer posude, ramena ili trbuha; *dB* – promjer dna; *dF* – promjer noge; *dH* – promjer drške; *hV* – visina posude, predmeta; *WT* – debljina stijenke; *CS* – boja po Munsellu vanjska; *CF* – boja po Munsellu na svježem lomu; *St* – obrada površine; *D* – ukras; *SJ* – stratigrafska jedinica; □ – kvadrant, *S* – sektor; *N* – nalaz; *T* – tip; *Fa* – struktura

1 Abbreviations used in the Catalogue of ceramic items: *dR* – rim diameter; *dN* – neck diameter; *dV* – diameter of the vessel (shoulder or body); *dB* – base diameter; *dF* – foot diameter; *dH* – handle diameter; *hV* – vessel, fragment height; *WT* – wall thickness; *CS* – surface colour by Munsell; *CF* – fresh break colour by Munsell; *S* – surface treatment; *D* – decoration; *SU* stratigraphic unit – □ quadrant, *A* – area; *F* – find; *T* – type; *Fa* – fabric



premaza, a boja pečenja je neujednačena (T. 1: 4).

dR – 15 cm; dN – 14,2 cm; WT – 0,6 cm; St – malo hrapava; CS – vani: smeđa (7,5YR 6/6), unutra: tamno siva (10YR3/1); CF – tamno siva (10YR3/1); SJ 007; □ P 31/32; S – VI; N – 53; T – L3; Fa – VKJ 2

5. Lonac s obodom čiji je rub zaobljen, a obod koso izvijen prema van. Vrat je jedva naglašen i koso se širi prema tijelu lonca. Nema premaza, posuda nije rađena na kolu (T. 1: 5).

dR – 19,1 cm; hV – 17,9 cm; WT – 0,3–0,6 cm; St – malo hrapava; CS – vani: crvena (7,5YR6/6), unutra: tamno siva (10YR4/1); CF – tamno siva (10YR4/1); SJ 007; □ P 31/32; N – 53; T – L4; Fa – VKJ 2

6. Ulomak lonca koso izvijenog oboda, ukošenog ruba. Vrat je jedva naglašen, a rame je ukošeno. Premaz je slabo očuvan na unutrašnjoj stijenci, boja pečenja je ujednačena (T. 1: 6).

WT – 0,7 cm; St – malo hrapava; CS – vani: smeđa (7,5YR6/4), unutra: tamno siva (10YR3/1); CF – tamno siva (10YR3/1–4/4); SJ 007; □ P 31/32; S – VI; N – 53; T – L4; Fa – VKJ 2

7. Ulomak tanjura neizraženog i blago zaobljenog oboda, bočne stjenke se sužavaju prema dnu i samo su blago zaobljene. Na vanjskoj stijenci i na obodu nalazi se djelomice sačuvan premaz crne boje, a na unutrašnjoj premaz smeđe sive boje (T. 1: 7).

dR – 20 cm; hV – 5,6 cm u sačuvanom dijelu; WT – 0,5–0,8 cm; St – malo hrapava, s premazom; CS – vani: siva (2,5Y4/1) do crna (5Y2,5/1), unutra: siva (2,5Y4/1), CF – siva (2,5Y4/1) do crna (5Y2,5/1); D – crni premaz na obodu i na vanjskoj strani, smeđi na unutarnjoj stijenci; SJ 007; □ P 31/32; S – VI; N – 53; T – T1; Fa – VKJ 2

8. Poklopac izrađen rukom od nepročišćene keramike s primjesama, nejednake boje pečenja. Drška je ravna i neznatno zadebljana, rub poklopca je ravan (T. 1: 8).

dR – 16 cm; hV – 8,5 cm; WT – od 0,5 do 2 cm; dH – 6,8 cm; St – malo hrapava; CS – vani: crvena (10R5/6 red), svijetlo smeđa (7,5YR6/4), tamno smeđa (7,5YR3/1), unutra: tamno smeđa (7,5YR3/1), smeđa (5YR5/6); SJ 007; □ P 32; S – VI; N – 73; T – P2; Fa – VKJ 2

9. Poklopac izrađen rukom, od nepročišćene keramike, s primjesama. Rub je ravan, dok je drška naglašena tako što je blago izvijena prema van, te je u sredini udubljena. Nejednake je boje pečenja (T. 1: 9).

dR – 19 cm; hV – 8,5 cm; WT – 0,7 do 2 cm; dH – 7 cm; St – malo hrapava; CS – vani: crvena (10R6/6) do siva (10YR8/2), unutra: crvena (10R6/6) do tamno smeđa (5YR2,5/1); SJ 007; □ P 32; S – VI; N – 73; T – P2; Fa – VKJ 2

se; CS – outer surface: brown (7.5YR 6/6), inner surface: dark gray (10YR3/1); CF – dark gray (10YR3/1); SU 007; □ P 31/32, A – VI; F – 53; T – L3; Fa – VKJ 2

- 5 A pot with a rounded edge and a slanting outward protruding rim. Slightly emphasized neck widening slantwise toward the body of a pot. Without slip. A pot was not made on the wheel (Pl. 1: 5).

dR – 19.1 cm; hV – 17.9 cm; WT – 0.3–0.6 cm; S – slightly coarse; CS – outer surface: red (7.5YR6/6), inner surface: dark gray (10YR4/1); CF – dark gray (10YR4/1); SU 007, □ P 31/32; F – 53; T – L4; Fa – VKJ 2

- 6 Fragment of a pot with a slantwise strained rim with a slanting edge. Neck slightly emphasized, slanting shoulder. Slip is poorly preserved on the inner wall, uniform firing colour (Pl. 1: 6).

WT – 0.7 cm; S – slightly coarse; CS – outer surface: brown (7.5YR6/4), inner surface: dark gray (10YR3/1); CF – dark gray (10YR3/1–4/4); SU 007, □ P 31/32; A – VI; F – 53; T – L4; Fa – VKJ 2

- 7 Fragment of a plate with an unemphasised and slightly rounded rim. Side walls are tapering toward the base and are only slightly rounded. Partly preserved black slip on the outer surface and on the rim, and brown slip on the inside (Pl. 1: 7).

dR – 20 cm; hV – 5.6 cm of the preserved part; WT – 0.5–0.8 cm; S – slightly coarse, with slip; CS – outer surface: gray (2.5Y4/1) to black (5Y2.5/1), inner surface: gray (2.5Y4/1), CF – gray (2.5Y4/1) to black (5Y2.5/1); D – black slip on the rim and the outer surface, brown on the inner surface; SU 007; □ P 31/32; A – VI; F – 53; T – T1; Fa – VKJ 2

- 8 Handmade lid, made of unrefined fabric with inclusions, with uneven firing colour. Straight, slightly thickened handle; straight edge of the lid (Pl. 1: 8).

dR – 16 cm; hV – 8.5 cm; WT – from 0.5 to 2 cm; S – slightly coarse; CS – outer surface: red (10R5/6 red), light brown (7.5YR6/4), dark brown (7.5YR3/1), inner surface: dark brown (7.5YR3/1), brown (5YR5/6); dH – 6.8 cm; SU 007; □ P 32; A – VI; F – 73; T – P2; Fa – VKJ 2

- 9 Straight edge. Slightly protruding outward, emphasized handle; recessed in the middle. Uneven firing colour (Pl. 1: 9).

dR – 19 cm; hV – 8.5 cm; WT – 0.7–2 cm; S – slightly coarse; CS – outer surface: red (10R6/6) to gray (10YR8/2), inner surface: red (10R6/6) to dark brown (5YR2.5/1); dH – 7 cm; SU 007, □ P 32, A – VI; F – 73; T – P2; Fa – VKJ 2

- 10 Fragment of the base of a mortar. The inner surface of the vessel has been roughened with small pebbles and has an olive-green glaze. The mortar has a small and



- 10.** Ulomak dna tarionika. Unutrašnja stjenka posude ogrubljen je sitnim kamenčićima sa zeleno maslinastom glazurom. Tarionik ima malu i jedva naglašenu prstenastu nogu te lagano zaobljeno dno (T. 1: 10).

$dR$  – 12 cm;  $hV$  – 5,2 cm u sačuvanom dijelu; WT – 1,1 cm, dno, 0,7 cm bočne stjenke; St – dno hrapavo, bočna vanjska stjenka je zaglađena, unutrašnjost je ogrubljena kamenčićima i glazirana je; CS – vani: svijetlo crvena (7,5YR7/6), unutra: zelena (5Y6/4); CF – prema vanjskoj stjenki svijetlo crvena (7,5YR7/8), prema unutrašnjoj siva (5Y7/1); SJ 007; □ P 31/32; S – VI; N – 53; T – Tr?; Fa – VKJ 16

#### SJ 013/014

- 11.** Lonac širokog oboda koji je kratak i koso izvijen prema van. Njegova stijenka je nešto deblja od stijenke same posude. Vrat je naglašen samim prijelazom oboda u koso rame. Ima slabo sačuvan premaz (T. 2: 1).

$dR$  – 18 cm;  $dV$  – >21 cm;  $dN$  – 17,5 cm; WT – 0,3 cm (rame), 0,7 cm (obod); St – glatka; CS – vani: narančasta (7,5YR6/6), siva (7,5YR5/1), unutra: crna (GLEY1 2,5/N); CF – crna (GLEY1 2,5/N); SJ 013; □ P 33; N – 128; T – L4; Fa – VKJ 2

- 12.** Lonac oboda izvijenog prema van s rubom koji je stanje. Posuda je grube izrade (T. 2: 2).

WT – 0,7 cm (rame); St – hrapava; CS – narančasto crvena (2,5YR5/3); CF – smeđa, crvena (2,5YR5/6–4/3); SJ 013; □ P 33; S – VI; N – 128; T – L8; Fa – VKJ 29

#### SJ 015/016

- 13.** Tanjur kosih stijenki, zaobljenog oboda čiji je rub na unutrašnjoj strani jastučasto oblikovan. Na unutrašnjoj strani djelomično je očuvan crveni premaz (T. 2: 4).

WT – 0,7 cm; St – glatka; CS – crvena (2,5YR7/4); CF – smeđe (2,5YR6/4); SJ 013; □ P 33; S – VI; N – 128; T – T2; Fa – VKJ 13

#### SJ 25/26

- 14.** Lonac manjih dimenzija širokog oboda koji je neznatno izvijen prema van. Vrat je vrlo kratak i prelazi u jedva naglašeno rame. Posuda je rađena rukom, nepravilne je izrade (T. 2: 5).

$dR$  – 15 cm;  $dV$  – 14,8 cm;  $dN$  – 16,7 cm; WT – 0,9 cm; St – neravna s rupicama; CS – vani: smeđa (2,5YR6/1), smeđa (10R4/1), unutra: smeđa (10R4/1); CF – crna (GLEY1 2,5/N), svijetlo smeđa (5YR7/3); SJ 025; □ N/O 33; S – VI; N – 65; T – L1; Fa – VKJ 2

- 15.** Lonac manjih dimenzija širokog oboda koji je neznatno izvijen prema van. Vrat je vrlo kratak i prelazi u jedva naglašeno rame. Posuda je rađena rukom (T. 2: 6).

$dR$  – 16 cm;  $dV$  – 16,8 cm;  $dN$  – 14,7 cm; WT – 0,9 cm; St – neravna s rupicama; CS – vani: siva (7,5YR6/1),

barely emphasized ring-foot and a slightly rounded base (Pl. 1: 10).

$dR$  – 12 cm;  $hV$  – 5.2 cm on the preserved part; WT – 1.1 cm base, 0.7 cm wall of the vessel; S – the base is coarse, outer wall is smoothed, inner wall is coarse with small pebbles and the glaze; CS – outer surface: bright red (7.5YR7/6), inner surface: green (5Y6/4); CF – toward the outer surface bright red (7.5YR7/8), toward the inner surface gray (5Y7/1); SU 007; □ P 31/32; A – VI; F – 53; T – Tr?; Fa – VKJ 16

#### SU 013/014

- 11** A pot with a wide, short outward protruding rim. The wall of the rim is somewhat thicker than the walls of the vessel itself. The neck is emphasized by the transition of the rim into the slanting shoulder. Poorly preserved slip (Pl. 2: 1).

$dR$  – 18 cm;  $dV$  – larger than 21 cm;  $dN$  – 17.5 cm; WT – 0.3 cm (shoulder), 0.7 cm (rim); S – smooth; CS – outer surface: orange (7.5YR6/6), gray (7.5YR5/1), inner surface: black (GLEY1 2.5/N); CF – black (GLEY1 2.5/N); SU 013; □ P 33; F – 128; T – L4; Fa – VKJ 2

- 12** A pot with an outward protruding rim with a thinned edge. Coarse craftsmanship (Pl. 2: 2).

WT – 0.7 cm (shoulder); S – coarse; CS – orange-red (2.5YR5/3); CF – brown, red (2.5YR5/6–4/3); SU 013, □ P 33, A – VI; F – 128; T – L8; Fa – VKJ 29

#### SJ 015/016

- 13** A plate with slanting walls and a rounded rim whose edge is pillow-shaped on the inside. Partly preserved red slip on the inside (Pl. 2: 4).

WT – 0.7 cm; S – smooth; CS – red (2.5YR7/4); CF – brown (2.5YR6/4); SU 013; □ P 33; A – VI; F – 128; T – T2; Fa – VKJ 13

#### SJ 25/26

- 14** A small pot with a wide, slightly outward protruding rim. Very short neck which exceeds into a slightly emphasized shoulder. Handmade vessel of poor craftsmanship (Pl. 2: 5).

$dR$  – 15 cm;  $dV$  – 14.8 cm;  $dN$  – 16.7 cm; WT – 0.9 cm; S – uneven with small holes; CS – outer surface: brown (2.5YR6/1), brown (10R4/1), inner surface: brown (10R4/1); CF – black (GLEY1 2.5/N), light brown (5YR7/3); SU 025; □ N/O 33; A – VI; F – 65; T – L1; Fa – VKJ 2

- 15** A small pot with a wide, slightly outward protruding rim. Very short neck which exceeds into a slightly emphasized shoulder. Handmade (Pl. 2: 6).

$dR$  – 16 cm;  $dV$  – 16.8 cm;  $dN$  – 14.7 cm; WT – 0.9 cm; S – uneven with small holes; CS – outer surface: gray (7.5YR6/1), orange (7.5YR6/6), inner surface: orange (7.5YR6/6), gray (GLEY1 4/N); CF – orange (7.5YR6/6),



narančasta (7,5YR6/6), unutra: narančasta (7,5YR6/6), siva (GLE1 4/N); CF – narančasta (7,5YR6/6), siva (7,5YR6/1); SJ 025; □ N/O 33; S – VI; N – 65; T – L1; Fa – VKJ 2

- 16.** Lonac čiji je obod malo izvijen prema van, vrat je kratak i odmah prelazi u široko tijelo dosta šire od oboda (T. 2: 7).

dR – 17,3 cm; dN – 16,5 cm; WT – 0,3 cm; St – hrapava, neravna; CS – vani: crvena (7,5YR6/6–5/6), unutra: smeđa (7,5YR3/1); CF – crvena prema vani (7,5YR6/6–5/6), smeđa prema unutra (7,5YR3/1); SJ 25; □ N/O 33; S – VI; N – 65; T – L1; Fa – VKJ 2

- 17.** Poklopac čiji je obod je ravan, stjenke su ravne i koso se sužavaju prema drški (T. 2: 8).

dR – 24,5 cm; WT – 0,5 cm; St – hrapava; CS – vani: crvena (10R5/6), unutra: crvena do smeđa (10R5/6–5YR4/1); CF – crvena do smeđa (10R5/6–3/1); SJ 25; □ N/O 33; S – VI; N – 64; T – P2; Fa – VKJ 2

- 18.** Ravno dno posude. Na dnu su jako slabo očuvani tragovi premaza. Unutrašnjost je prekrivena jako zapečenom i popucalom naslagom crne boje koja se uhvatila na premaz. Dno je moglo pripadati tanjuru, zdjeli ili loncu (T. 2: 9).

dB – 18 cm; WT – 0,7 cm; St – glatka; CS – vani: crvena (5YR6/4), unutra: crna (GLE1 2,5/N); CF – crna (GLE1 2,5/N); SJ 25; □ N/O 33; S – VI; N – 64; T – dno; Fa – VKJ 2

- 19.** Ravno dno posude, grube i nepravilne izrade. Nema tragova premaza. Moguće da je posuda pripadala manjem loncu ili vrču (T. 2: 10).

dB – 8,5 cm; WT – 0,6 cm; St – glatka; CS – siva (7,5YR4/1); CF – crna (GLE1 2,5/N); SJ 25; □ N/O 33; S – VI; N – 64; T – dno; Fa – VKJ 2

- 20.** Ravno dno posude. Na dnu su jako slabo očuvani tragovi premaza. Unutrašnjost je prekrivena jako zapečenom i popucalom naslagom crne boje koja se uhvatila na premaz. Dno je moglo pripadati tanjuru, zdjeli ili loncu (T. 2: 11).

dB – 16 cm; WT – 0,8 cm; St – glatka; CS – vani: crvena (2,5YR6/4), unutra: crna (GLE1 2,5/N); CF – smeđa (2,5YR3/1–5/6); SJ 25; □ N/O 33; S – VI; N – 64; T – dno; Fa – VKJ 2

- 22.** Stijenka posude od sivo pečene i dobro pročišćene keramike. Vjerojatno je riječ o loncu ili vrču (T. 2: 12).

WT – 0,4–0,5 cm; St – glatka; CS – vani: siva (GLE1 6/N), unutra: siva (GLE1 7/N); CF – siva (GLE1 5/N); SJ 013, □ P 33; S – VI; N – 128; T – ?; Fa – VKJ 11

- 23.** Tanjur kosih stijenki, zaobljenog oboda čiji je rub na

gray (7.5YR6/1); SU 025; □ N/O 33; A – VI; F – 65; T – L1; Fa – VKJ 2

- 16** A pot with a slightly protruding rim, and a short neck which exceeds into a wide body, much wider than the rim (Pl. 2: 7).

dR – 17.3 cm; dN – 16.5 cm; WT – 0.3 cm; S – coarse, uneven; CS – outer surface: red (7.5YR6/6–5/6), inner surface: brown (7.5YR3/1); CF – red toward the outer surface (7.5YR6/6–5/6), brown toward the inner surface (7.5YR3/1); SU 25, □ N/O 33; A – VI; F – 65; T – L1; Fa – VKJ 2

- 17** A lid with a straight rim and straight walls which taper toward the handle (Pl. 2: 8).

dR – 24.5 cm; WT – 0.5 cm; S – coarse; CS – outer surface: red (10R5/6), inner surface: red to brown (10R5/6–5YR4/1); CF – red to brown (10R5/6–3/1); SU 25, □ N/O 33; A – VI; F – 64; T – P2; Fa – VKJ 2

- 18** Flat base of a vessel. Poorly preserved traces of slip on the bottom. The inside is covered by burned and cracked black layer sticking to slip. It could be the base of a plate, a bowl or a pot (Pl. 2: 9).

dB – 18 cm; WT – 0.7 cm; S – smooth; CS – inner surface: red (5YR6/4), outer surface: black (GLE1 2.5/N); CF – black (GLE1 2.5/N); SU 25; □ N/O 33; A – VI; F 64; T – base; Fa – VKJ 2

- 19** Flat base of a vessel of coarse and poor craftsmanship. No traces of slip. It could be the base of a smaller pot or a jug (Pl. 2: 10).

dB – 8.5 cm; WT – 0.6 cm; S – smooth; CS – gray (7.5YR4/1); CF – black (GLE1 2.5/N); SU 25; □ N/O 33; A – VI; F – 64; T – base; Fa – VKJ 2

- 20** Flat base of a vessel. Poorly preserved traces of slip on the bottom. The inside is covered by burned and cracked black layer sticking to slip. It could be the base of a plate, a bowl or a pot (Pl. 2: 11).

dB – 16 cm; WT – 0.8 cm; S – smooth; CS – outer surface: red (2.5YR6/4), inner surface: black (GLE1 2,5/N); CF – brown (2.5YR3/1–5/6); SU 25; □ N/O 33; A – VI; F – 64; T – base; F – VKJ 2

- 22** The wall of a vessel made of gray fired well refined ceramics. Probably a pot or a jug (Pl. 2: 12).

WT – 0.4–0.5 cm; S – smooth; CS – outer surface: gray (GLE1 6/N), inner surface: gray (GLE1 7/N); CF – gray (GLE1 5/N); SU 013; □ P 33; A – VI; F – 128; T – ?; Fa – VKJ 11

- 23** A plate with slanting walls and a rounded rim whose edge is pillow-shaped on the inside. Partly preserved red slip on the outside and on the inside (Pl. 2: 13).



unutrašnjoj strani jastučasto oblikovan. Na unutrašnjoj i vanjskoj strani djelomično je očuvan crveni premaz (T. 2: 13).

WT – 0,6 cm; St – glatka; CS – crvena (2,5YR7/4); CF – smeđe (2,5YR6/4); SJ 013; □ P 33; S – VI; N – 128; T – T2; Fa – VKJ 13

### SJ 034/035

**24.** Ulomci dolija. Očuvan je donji dio posude. Dno je ravno, blago je u sredini izdignuto. Bočne stijenke se koso šire prema trbuhu. Posuda je rađena rukom. Na unutrašnjoj strani su dobro vidljivi otisci drvenih daščica lončara (T. 3: 1).

*d*B – 37,5 cm; WT – 0,6–1 cm; CS – CF – tamno siva–siva (GLEY1 4/N–8/10Y); SJ 034; □ N 32/33; S – VI; PN – 9; T – dolij; Fa – VKJ 2

## Kompleks 2

### SJ 114/115

**25.** Lonac širokog oboda koji je koso izvijen prema van, a s vanjske strane na prijelazu u vrat na nekim mjestima je malo zadebljan. Rame je zaobljeno i šire od oboda (T. 4: 1).

*d*R – 20 cm; *d*N – 19,2 cm WT – 0,3 cm; St – hrapava; CS – vani: crvena (2,5YR5/8) do siva (GLEY1 3/N) unutra: siva (5YR3/1); CF – (GLEY1 3/N); SJ 114; □ W 28/29; S – VI; N – 543; T – L3; Fa – VKJ 2

**26.** Poklopac s drškom koja je s unutrašnje strane šuplja. Stjenke se vrlo blago šire prema obodu (T. 4: 2).

WT – 0,8 cm; *d*H – 6,4 cm; St – hrapava; CS – vani: smeđa (5YR4/1) do ružičasta (7,5YR7/4), unutra: crna (GLEY1 2,5/N); CF – smeđa (5YR4/1); SJ 114; □ W 28/29; S – VI; N – 543; T – P?; Fa – VKJ 2

### SJ 362/363

**27.** Ulomak oboda koso izvijenog lonca (T. 4: 3).

WT – 0,7 cm; CS – vani: crvena (2,5YR6/4), unutra (GLEY1 4/N); CF – crna do crvena (GLEY1 4/N, 2,5YR6/4); SJ 362/362; □ W 2; S – VI; T – L?; Fa – VKJ 2

**28.** Ulomak oboda lonca. Obod je neznatno izvijen (T. 4: 4).

WT – 1,1 cm; CS – CF vani: tamnosiva (GLEY1 4/N); SJ 362/362; □ W 2; S – VI; T – L8; Fa – VKJ 1

### SJ 374/375

**29.** Tanjur ravnog dna. Bočne stijenke konkavno su zaobljene, obod je malo zakrenut prema unutra i malo je zadebljan. Bočne stijenke se prema obodu sužavaju. Unutrašnja strana posude i oboda ima crni premaz (T. 4: 5).

*d*R – 22,6 cm; *d*B – 19,9 cm; *h*V – 6 cm; WT – 0,6–0,9 cm; St – zaglađena; CS – vani: smeđa (7,5YR6/3) do si-

WT – 0,6 cm; S – smooth; CS – red (2.5YR7/4); CF – brown (2.5YR6/4); SU 013, □ P 33, A VI; F 128; T – T2; Fa – VKJ 13

### SU 034/035

**24** Fragments of dolium. Lower part of the vessel is preserved. Flat base, slightly raised in the middle. Side walls obliquely widening toward the body. Handmade vessel. Traces of potters wooden tools clearly visible on the inside (Pl. 3: 1).

*d*B – 37.5 cm; WT – 0.6–1 cm; CS – CF – dark gray–gray (GLEY1 4/N–8/10Y); SU 034; □ N 32/33; A – VI; SF – 9; T – dolium; Fa – VKJ 2

## Complex 2

### SU 114/115

**25** A pot with a wide obliquely protruding rim, slightly thickened in places on the outer side on the transition to the neck. Rounded shoulder, wider than the rim (Pl. 4: 1).

*d*R – 20 cm; *d*N – 19.2 cm; WT – 0.3 cm; S – coarse; CS – outer surface: red (2.5YR5/8) to gray (GLEY1 3/N) inner surface: gray (5YR3/1); CF – (GLEY1 3/N); SU 114; □ W 28/29; A – VI; F – 543; T – L3; Fa – VKJ 2

**26** A lid with a hollow handle. Walls slightly widening toward the rim (Pl. 4: 2).

WT – 0.8 cm; S – coarse; CS – outer surface: brown (5YR4/1) to pink (7.5YR7/4), inner surface: black (GLEY1 2.5/N); CF – brown (5YR4/1); *d*H – 6.4 cm; SU 114; □ W 28/29; A – VI; F – 543; T – P?; Fa – VKJ 2

### SU 362/363

**27** Fragment of the obliquely protruding rim of a pot (Pl. 4: 3).

WT – 0.7 cm; CS – outer surface: red (2.5YR6/4), inner surface: red (GLEY1 4/N); CF – black to red (GLEY1 4/N; 2.5YR6/4); SU 362/362; □ W 2; A VI; T – L?; Fa – VKJ 2

**28** Fragment of the slightly protruding rim of a pot (Pl. 4: 4).

WT – 1.1 cm; CS – CF outer surface: dark gray (GLEY1 4/N); SU 362/362; □ W 2; A – VI, T – L8; Fa – VKJ 1

### SU 374/375

**29** Flat based plate. Side walls concavely rounded, rim slightly protruding inward and thickened. Side walls tapering toward the rim. Black slip on the inside wall and the rim (Pl. 4: 5).

*d*R – 22.6 cm; *d*B – 19.9 cm; *h*V – 6 cm; WT – 0.6–0.9 cm; S – smoothed; CS – outer surface: brown (7.5YR6/3) to gray (2.5Y3/1), inner surface: brown (7.5YR6/3) to black (GLEY1 2.5/N); CF – brown (7.5YR6/3); D – black slip on the inner surface; SU 374, □ X 26, A – VI; F – 354; T – T2; Fa – VKJ 2



va (2,5Y3/1), unutra: smeđa (7,5YR6/3) do crna (GLE Y1 2,5/N); CF – smeđa (7,5YR6/3); D – crni premaz s unutrašnje strane; SJ 374; □ X 26; S – VI; N – 354; T – T2; Fa – VKJ 2

**SJ 425/426**

**30.** Lonac širokog oboda velikih dimenzija. Obod je malo izvijen prema van i neznatno profiliran. Vrat je kratak. Površina je jako gruba i nema nikakve obrade na njoj. Pronađeni su ulomci dna koji vjerojatno pripadaju istoj posudi (T. 4: 6).

*dR* – 35,8 cm; *dN* – 25,2 cm; *dB* – 8 cm; *WT* – 0,8 cm; *St* – jako hrapava, bez obrade; *CS* – tamno siva (GLE Y1 3/N); *CF* – tamno siva (GLE Y1 3/N); SJ 425; □ V 28; S – VI; N – 310; T – L1; Fa – VKJ 1

**31.** Ulomak lonca širokog oboda. Obod je ravan i koso izvijen prema van. Vrat je kratak i odmah se širi u zaobljeno rame. Na unutrašnjoj strani oboda sačuvan je trag crnog premaza (T. 4: 7).

*dR* – 14,2 cm; *dN* – 13,6 cm; *WT* – 0,5 cm; *St* – bez posebne obrade, malo hrapava; *CS* – vani: smeđa (7,5YR5/2), unutra: smeđa (10YR4/1); *CF* – smeđa (10YR4/1); SJ 425; □ V 28; S – VI; N 310; T – L3; Fa – VKJ 2

**32.** Lonac širokog oboda koji je koso izvijen prema van. Vrat je kratak, samo je naznačen i odmah prijelazi u blago zaobljeno rame. Nema tragova premaza (T. 4: 8).

*dR* – 19,1 cm; *dN* – 17,2 cm; *WT* – 0,4 cm; *St* – bez posebne obrade; *CS* – vani: smeđa (7,5YR7/6), unutra: smeđa (7,5YR7/6), siva (GLE Y1 4/N); *CF* – smeđa (7,5YR7/6) siva; SJ 425; □ V 28; S – VI; N – 310; T – L3; Fa – VKJ 2

**33.** Ulomak lonca širokog oboda koji je koso izvijen prema van. Vrat je kratak i širi se u zaobljeno rame (T. 4: 9).

*dR* – 16 cm; *dN* – 14,1 cm; *WT* – 0,4 cm; *St* – malo hrapava; *CS* – vani: crvena (2,5YR6/6), unutra: narančasta (7,5YR6/6), siva (7,5YR5/2); *CF* – crvena (2,5YR6/6), siva (GLE Y1 4/N), smeđa (7,5YR6/6); SJ 425; □ V 28; S – VI; N – 310; T – L3; Fa – VKJ 2

**34.** Lonac širokog oboda koji je koso izvijen prema van i rub mu je zaobljen. Vrat je tek neznatno naglašen i koso se širi u trbuh. Nema tragova premaza i obrade površine (T. 4: 10).

*dR* – 13 cm; *dN* – 12,4 cm; *WT* – 0,3–0,8 cm, najdeblja na vratu, prema trbuhu se sužava; *St* – hrapava šupljikava; *CS* – vani: svijetlo siva (5Y6/1), unutra: tamno siva (GLE Y1 4/N); *CF* – siva (GLE Y1 7/N); SJ 425; □ V 28; S – VI; N – 310; T – L4; Fa – VKJ 2

**35.** Lonac širokog oboda koji je koso izvijen prema van. Vrat je kratak i koso se širi u trbuh (T. 4: 11).

*dR* – 16 cm; *dN* – 14,7 cm; *WT* – 0,3 cm trbuh, 0,45–0,6

**SU 425/426**

**30** Large pot with wide rim. Slightly outward protruding and lightly profiled rim. Short neck. Very coarse, surface without further treatment. Fragments of a base probably belonging to the same vessel have been found (Pl. 4: 6).

*dR* – 35.8 cm; *dN* – 25.2 cm; *dB* – 8 cm; *WT* – 0.8 cm; *S* – very coarse, without further treatment; *CS* – dark gray (GLE Y1 3/N); *CF* – dark gray (GLE Y1 3/N); SU 425; □ V 28; A – VI; F – 310; T – L1; Fa – VKJ 1

**31** Fragment of a pot with a wide rim. Straight, obliquely outward protruding rim. Short neck which widens into the rounded shoulder. Traces of black slip preserved on the inside of the rim (Pl. 4: 7).

*dR* – 14.2 cm; *dN* – 13.6 cm; *WT* – 0.5 cm; *S* – without further special treatment, slightly coarse; *CS* – outer surface: brown (7.5YR5/2), inner surface: red brown (10YR4/1); *CF* – brown (10YR4/1); SU 425; □ V 28; A – VI, F – 310; T – L3; Fa – VKJ 2

**32** A pot with a wide, obliquely outward protruding rim. Short, merely emphasized neck which immediately transgresses into a slightly rounded shoulder. No traces of slip (Pl. 4: 8).

*dR* – 19.1 cm; *dN* – 17.2 cm; *WT* – 0.4 cm; *S* – without further treatment; *CS* – outer surface: brown (7.5YR7/6), inner surface: brown (7.5YR7/6), gray (GLE Y1 4/N); *CF* – brown (7.5YR7/6); SU 425; □ V 28; A – VI; F – 310; T – L3; Fa – VKJ 2

**33** A fragment of a pot with a wide, obliquely outward protruding rim. Short neck which widens into the rounded shoulder (Pl. 4: 9).

*dR* – 16 cm; *dN* – 14.1 cm; *WT* – 0.4 cm; *S* – slightly coarse; *CS* – outer surface: red (2.5YR6/6), inner surface: orange (7.5YR6/6), gray (7.5YR5/2); *CF* – red (2.5YR6/6), gray (GLE Y1 4/N), brown (7.5YR6/6); SU 425; □ V 28; A – VI; F – 310; T – L3; Fa – VKJ 2

**34** A pot with a wide, obliquely outward protruding rim with a rounded edge. Short, merely emphasized neck obliquely widening into the body. Without traces of slip or further treatment of the surface (Pl. 4: 10).

*dR* – 13 cm; *dN* – 12.4 cm; *WT* – 0.3–0.8 cm, thickest on the neck, thinning towards the body; *S* – coarse with holes; *CS* – outer surface: bright gray (5Y6/1), inner surface: dark gray (GLE Y1 4/N); *CF* – gray (GLE Y1 7/N); SU 425; □ V 28; A – VI; F – 310; T – L4; Fa – VKJ 2

**35** A pot with a wide obliquely outward protruding rim. Short neck obliquely widening into the body (Pl. 4: 11).

*dR* – 16 cm; *dN* – 14.7 cm; *WT* – 0.3 cm body, 0.45–0.6 cm neck and the rim; *S* – slightly coarse; *CS* – brown



- cm vrat i obod; St – malo hrapava; CS – smeđa (10YR6/4); CF – smeđa (10YR6/4); SJ 425; □ V 28; S – VI; N – 310; T – L4; Fa – VKJ 2
- 36.** Lonac širokog oboda koji je koso izvijen prema van i kružno zaobljen. Vrat je kratak i koso prelazi u tijelo (T. 4: 12).  
dR – 14 cm; dV – više od 17 cm; dN – 12,8 cm; WT – 0,2–0,6 cm (najdeblja stjenka je na vratu); St – hrapava, neravna; CS – vani: siva (GLE1 5/N), unutra: siva (GLE1 3/N), žuta (2,5Y8/6); CF – siva (GLE1 3/N), žuta (2,5 Y 8/6); SJ 425; □ V 28; S – VI; N – 310; T – L4; Fa – VKJ 2
- 37.** Lonac širokog oboda koji je koso izvijen prema van. Vrat je zadebljan s unutrašnje strane i malo naglašen, kratak je i koso prelazi u rame (T. 4: 13).  
dR – 13,1 cm; dN – 12,3 cm; WT – 0,4–0,5 cm; St – hrapava; CS – smeđa (10YR7/2) crvena (5YR6/6); CF – smeđa (10YR7/2) crvena (5YR6/6); SJ 425; □ V 28; N – 310; T – L4; Fa – VKJ 2
- 38.** Tava, u obliku plitke zdjele s drškom. Ima crni premaz na vanjskoj i unutrašnjoj stijenci pa je prema tome vjerojatno služila za pripremanje hrane. Rađena je rukom, glina je nepročišćena s malo primjesa. Obod je kratak i blago je izvijen prema van (T. 4: 14).  
dR – 14,6 cm, dB – 8,4 cm; hV – 4 cm; WT – 0,6 cm; St – malo hrapava s tragovima crnog premaza; CS – vani: tamno smeđa (7,5YR4/2) do crna (GLE1 2,5/N) s tragovima crnog premaza, unutra: smeđa (10YR6/2) do tamno smeđa (7,5YR4/2) s tragovima crnog premaza; dH – 2,2 cm; D – crni premaz na vanjskoj i unutrašnjoj strani; SJ – 425; □ U 28; S – VI; N – 315; T – tava; Fa – VKJ 2
- 39.** Ulomak dna posude. Dno je ravno, bočne stijenske se koso šire prema trbuhu. Na površini nema očuvanog premaza (T. 5: 1).  
dB – 14 cm; WT – 0,9 cm; CS – smeđesiva (7,5YR6/4–2,5Y4/1); CF – smeđecrna (7,5YR2,5/1); SJ 425; □ V 28/29; S – VI; N – 313; T – ?; Fa – VKJ 2
- 40.** Ulomak dna posude bez očuvanog premaza. Dno je ravno, bočne stijenske se koso šire prema trbuhu (T. 5: 2).  
dB – 12 cm; WT – 0,3–0,8 cm; CS – smeđesiva (7,5YR6/4–2,5Y4/1); CF – smeđecrna (7,5YR2,5/1); SJ – 425; □ V 28/29; S – VI; N – 313; T – ?; Fa – VKJ 2
- 41.** Ulomak posude, vjerojatno zdjele. Obod je neizražen, rub zaobljen. Na unutrašnjoj i vanjskoj stijenci je djelomično očuvan crni premaz (T. 5: 3).  
WT – 0,5 cm; St – glatka, s premazom; CS – CF – siva (5YR4/1); SJ 425; □ V 28/29; S – VI; N – 313; T – Z1; Fa – VKJ 2
- (10YR6/4); CF – brown (10YR6/4); SU 425; □ V 28; A – VI; F – 310; T – L4; Fa – VKJ 2
- 36** A pot with a wide, obliquely outward protruding, rounded rim. Short neck with a slanting transition into the body (Pl. 4: 12).  
dR – 14 cm; dV – more than 17 cm; dN – 12.8 cm; WT – 0.2–0.6 cm (the wall is thickest on the neck); S – coarse, uneven; CS – outer surface: gray (GLE1 5/N), inner surface: gray (GLE1 3/N), yellow (2.5Y8/6); CF – gray (GLE1 3/N), yellow (2.5 Y 8/6); SU 425; □ V 28; A – VI, F – 310; T – L4; Fa – VKJ 2
- 37** A pot with a wide, obliquely outward protruding rim. The neck is thickened on the inside, slightly emphasized and with a slanting transition to the shoulder (Pl. 4: 13).  
dR – 13.1 cm; dN – 12.3 cm; WT – 0.4–0.5 cm; S – coarse; CS – brown (10YR7/2), red (5YR6/6); CF – brown (10YR7/2), brown (5YR6/6); SU 425; □ V 28; F – 310; T – L4; Fa – VKJ 2
- 38** A pan in a form of a shallow bowl with a handle. Black slip on the outside as well as on the inside indicates that it was used for preparing food. Handmade of unrefined clay with scarce inclusions. Short slightly outward protruding rim (T 4: 14).  
dR – 14.6 cm; dB – 8.4 cm; hV – 4 cm; WT – 0.6 cm; S – slightly coarse with traces of black slip; CS – outer surface: dark gray (7.5YR4/2) to black (GLE1 2.5/N) with traces of black slip, inner surface: brown (10YR6/2) to dark brown (7.5YR4/2) with traces of black slip; dH – 2.2 cm; D – black slip on the outer and on the inner surface; SU 425; □ – U 28; A – VI; F – 315; T – pan; Fa – VKJ 2
- 39** Fragment of the base of a vessel. Flat base; side walls obliquely widening toward the body. Without preserved slip on the surface (Pl. 5: 1).  
dB – 14 cm; WT – 0.9 cm; CS – brown–gray (7.5YR6/4–2.5Y4/1); CF – brown to black (7.5YR2.5/1); SU 425, □ V 28/29, A – VI; F – 313; T – ?; Fa – VKJ 2
- 40** Fragment of the base of a vessel without preserved slip. Flat base; side walls obliquely widening toward the body (Pl. 5: 2).  
dB – 12 cm; WT – 0.3–0.8 cm; CS – brown to gray (7.5YR6/4; 2.5Y4/1); CF – brown to black (7.5YR2.5/1); SU – 425; □ V 28/29; A – VI; F – 313; T – ?; Fa – VKJ 2
- 41** Fragment of a vessel, probably a bowl. Unemphasised rim, rounded edge. Partly preserved black slip on the inside and on the outside (Pl. 5: 3).  
WT – 0.5 cm; S – smooth with slip; CS – CF – gray (5YR4/1); SU 425; □ – V 28/29; A – VI; F – 313; T – Z1; Fa – VKJ 2





- 42.** Ulomak dna posude grube izrade. Dno je ravno i masivno, bočne stijenke se koso šire prema trbuhu (T. 5: 4).  
*dH* – 8,5 cm; *WT* – 1 cm; *CS* – siva do narančasta (7,5YR5/6–10YR4/1); *CF* – (10YR3/1); *SJ* 425; □ *V* 28/29; *S* – VI; *N* – 313; *T* – ?; *Fa* – VKJ 2
- 43.** Ulomak trakaste drške manjeg vrča bez očuvanog premaza (T. 5: 5).  
*dH* – 1,9 x 0,8 cm; *CS* – narančasta (5YR6/8); *CF* – narančasta (5YR6/8); *SJ* 425; □ *V* 28/29; *S* – VI; *N* – 313; *T* – ?; *Fa* – VKJ 13
- 44.** Ulomak profilirane drške, vjerojatno vrča (T. 5: 6).  
*dH* – 2,3 x 3,2 cm; *CS* – crvena do siva (5YR6/8–GLE1 7/10Y); *CF* – siva (GLE1 4/N); *SJ* 425; □ *V* 28/29; *S* – VI; *N* – 313; *T* – ?; *Fa* – VKJ 9
- 45.** Ulomak ramena vrča ili lonca izrađenog na kolu. Rame je blago zaobljeno. Nema očuvanog premaza (T. 5: 7).  
*WT* – 0,8 cm; *CS* – siva (GLE1 4/N); *CF* – smeđa (10R4/2); *SJ* 425; □ *V* 28/29; *S* – VI; *N* – 313; *T* – ?; *Fa* – VKJ 5
- 46.** Ulomak trbuha posude izrađene na kolu pročišćene strukture. Na površini nema tragova očuvanog premaza (T. 5: 8).  
*WT* – 0,5 cm; *CS* – narančasta do siva (7,5YR7/6–7/1); *CF* – siva (7,5YR5/1); *SJ* 425; □ *V* 28/29; *S* – VI; *N* – 313; *T* – ?; *Fa* – VKJ 23
- 47.** Ulomak ramena posude izvrsne izrade s djelomično očuvanim premazom na vanjskoj strani (T. 5: 9).  
*WT* – 0,4 cm; *D* – gusti, sjajni premaz; *CS* – smeđa do siva (7,5YR6/4–10R5/1), premaz: crven (10R5/8); *CF* – siva (GLE1 4/N); *SJ* 425; □ *V* 28/29; *S* – VI; *N* – 313; *T* – ?; *F* – ?
- SJ 427/428**
- 48.** Ulomak lonca s dvije drške. Obod lonca blago je izvijen prema van i zaobljen je, vrat je jedva naglašen i prelazi u rame. Najveća širina posude je u središnjem dijelu trbuha, pa lonac ima loptasti presjek. Drške su malo profilirane i dižu se neznatno iznad oboda. Ispod spoja drški s trbuhom posude, ona se naglo sužava. Na posudi nema tragova premaza (T. 8: 1a–b).  
*dR* – 11 cm; *dV* – 14 cm; *dN* – 10,6 cm; *dH* – 1,7 x 0,9 cm; *hV* – 9,2 cm u sačuvanom dijelu; *WT* – 0,6 cm; *CS* – vani: smeđa (7,5YR5/2), unutra: smeđa (7,5YR5/2) do siva (7,5Y3/1); *CF* – smeđa (7,5YR5/2) do siva (7,5Y3/1); *SJ* 427; □ *U* 27; *S* – VI; *N* – 321; *T* – L5; *Fa* – VKJ 2
- 49.** Ulomak lonca s dvije drške. Očuvan je dio drške i tijela lonca. Drška je blago profilirana (T. 8: 2).  
*dH* – 2,5 x 1 cm; *CS* – smeđa (7,5YR6/4); *CF* – smeđa (7,5YR4/3); *SJ* 427; □ *U* 27; *S* – VI; *N* – 321; *T* – L5; *Fa* – VKJ 2
- 42** Fragment of the base of a coarse vessel. Flat, massive base; side walls obliquely widening toward the body (Pl. 5: 4).  
*dH* – 8.5 cm; *WT* – 1 cm; *CS* – gray to orange (7.5YR5/6–10YR4/1); *CF* – (10YR3/1); *SU* 425; □ *V* 28/29; *A* – VI; *F* – 313; *T* – ?; *Fa* – VKJ 2
- 43** Fragment of a ribbon-like handle of a smaller jug without preserved slip (Pl. 5: 5).  
*dH* – 1.9 x 0.8 cm; *CS* – orange (5YR6/8); *CF* – orange (5YR6/8); *SU* – 425; □ *V* 28/29; *A* – VI; *F* – 313; *T* – ?; *Fa* – VKJ 13
- 44** Fragment of a profiled handle, probably of a jug (Pl. 5: 6).  
*dH* – 2.3 x 3.2 cm; *CS* – red to gray (5YR6/8–GLE1 7/10Y); *CF* – gray (GLE1 4/N); *SU* 425; □ *V* 28/29; *A* – VI; *F* – 313; *T* – ?; *Fa* – VKJ 9
- 45** Fragment of the shoulder of a jug or a pot made on a wheel. Slightly rounded shoulder. Without preserved slip (Pl. 5: 7).  
*WT* – 0.8 cm; *CS* – gray (GLE1 4/N); *CF* – brown (10R4/2); *SU* 425; □ *V* 28/29; *A* – VI; *F* – 313; *T* – ?; *Fa* – VKJ 5
- 46** Fragment of the body of a vessel made on a wheel out of refined fabric. No traces of preserved slip on the surface (Pl. 5: 8).  
*WT* – 0.5 cm; *CS* – orange to gray (7.5YR7/6–7/1); *CF* – gray (7.5YR5/1); *SU* 425; □ *V* 28/29; *A* – VI; *F* – 313; *T* – ?; *Fa* – VKJ 23
- 47** Fragment of the shoulder of a exquisitely made vessel with partly preserved slip on the outside (Pl. 5: 9).  
*WT* – 0.4 cm; *CS* – brown to gray (7.5YR6/4–10R5/1), slip: red (10R5/8); *CF* – gray (GLE1 4/N); *SU* 425; □ *V* 28/29; *A* – VI; *F* – 313; *D* – thick, shiny slip; *T* – ?; *Fa* – ?
- SU 427/428**
- 48** Fragment of a pot with two handles. The rim of the pot is slightly protruding outward and rounded while the neck is merely emphasized and exceeding into the shoulder. The vessel is widest at the middle part of the body, therefore its cross-section is globular. Handles are somewhat profiled and rise slightly above the rim. The vessel abruptly narrows below the joint of the handle with the body. There are no traces of slip (Pl. 8: 1a–b).  
*dR* – 11 cm; *dV* – 14 cm; *dN* – 10.6 cm; *dH* – 1.7 x 0.9 cm; *hV* – 9.2 cm on the preserved part; *WT* – 0.6 cm; *CS* – outer surface: brown (7.5YR5/2), inner surface: brown (7.5YR5/2) to gray (7.5Y3/1); *CF* – brown (7.5YR5/2) to gray (7.5Y3/1); *SU* 427; □ *U* 27; *A* – VI; *F* – 321; *T* – L5; *Fa* – VKJ 2



- 50.** Ulomak lonca s dvije drške. Obod je malo izvijen prema van i trokutastog je presjeka, dok mu je vrh zaobljen. Sačuvan je premaz. Drška je malo profilirana, kao i kod prethodne posude (T. 8: 3).  
*dR* – 16 cm; *dV* – 22,4 cm; *dN* – 14,8 cm; *hV* – 16 cm u sačuvanom dijelu; *dH* – 3,1 x 1,4 cm; WT – 0,6 cm; CS – smeđa (7,5YR6/4); CF – smeđa (7,5YR5/4); SJ 427; □ U 27; S – VI; N – 321; T – L5; Fa – VKJ 2
- 51.** Ulomak lonca grube izrade. Rađen je bez kola. Obod je blago izvijen, rub zadebljan, površina je hrapava (T. 8: 4).  
*dR* – 33 cm; *dN* – 32 cm; WT – 0,8 cm; CS – crna (GLE1 3/N); CF – crna (GLE1 2,5/N); St – jako hrapava; SJ 427; □ U 27; S – VI; N – 321; T – L8; Fa – VKJ 1
- 52.** Ulomak lonca izvijenog oboda, proširenog ruba. Vrat je nizak i cilindričan i širi se u zaobljeno rame. Površina je gruba i hrapava, lonac je nepravilne izrade (T. 8: 5).  
 WT – 0,7 cm; CS – smeđa (7,5YR4/2); CF – tamno smeđa (7,5YR2,5/1); St – gruba, hrapava; SJ 427; □ U 27; S – VI; N – 321; T – L8; Fa – VKJ 24
- 53.** Ulomak lonca koso izvijenog oboda i koso postavljene ramena. Nema očuvan premaz (T. 8: 6).  
 WT – 0,6 cm; CS – narančasta (7,5YR6/4–5YR6/8); CF – siva do narančasta (5YR5/6–5/1); SJ 427; □ U 27; S – VI; N – 321; T – L4?; Fa – VKJ 2
- 54.** Tanjur ravnog dna i neznatno zadebljanog oboda okrenutog prema unutra. Stijenke su kose, boja pečenja je nejednaka, a u sastavu glina ima vrlo sitnih primjesa. Na unutrašnjoj stijenci nalazi se crni premaz, pretpostavlja se da se u tanjuru mogla držati tekućina (T. 8: 7).  
*dR* – 23 cm; *dB* – 16 cm; *hV* – 5,1 cm; WT – 0,6 cm; St – malo hrapava, s unutrašnje strane crni premaz; CS – vani: crvena (5YR6/4), smeđa (5YR5/4), crna (10YR3/1), unutra: siva (10YR3/1) boja pečenja s crnim premazom (2,5Y2,5/1); CF – neujednačena; D – s unutrašnje strane ima crni premaz; SJ 427; □ U 27/28; S – VI; N – 338; T – T1; Fa – VKJ 2
- 55.** Ulomak poklopca s drškom koja je prstenastog oblika, ali je neurednog i nepravilnog izgleda. S unutrašnje strane drška je ispunjena. Bočne stijenke su malo zaobljene prema unutrašnjoj strani (T. 8: 8).  
*hV* – 9,2 u očuvanom dijelu; *dH* – 0,35 cm; WT – 0,5–1,8 cm; St – malo hrapava; CS – vani: tamno siva (10YR4/1) do smeđa (7,5 YR5/3), unutra: crna (5Y3/1) do smeđa (7,5YR6/4); CF – smeđa (7,5YR6/4); SJ 427; □ U 27; S – VI; N – 321; T – P1; Fa – VKJ 2
- 56.** Ulomak poklopca s drškom koja se prema vrhu širi i s gornje strane ima udubljenje, u presjeku je ispunjena
- 49** fragment of a pot with two handles. A part of the handle and of the body of a pot is preserved. The handle is slightly profiled (Pl. 8: 2).  
*dH* – 2.5 x 1 cm; CS – brown (7.5YR6/4); CF – brown (7.5YR4/3); SU 427; □ U 27; A – VI; F – 321; T – L5; Fa – VKJ 2
- 50** Fragment of a pot with two handles. Slightly outward protruding rim of a triangular cross-section with a rounded tip. Slip is preserved. Slightly profiled handle, same as on the previous vessel (Pl. 8: 3).  
*dR* – 16 cm; *dV* – 22.4 cm; *dN* – 14.8 cm; *hV* – 16 cm on the preserved part; *dH* – 3.1 x 1.4 cm; WT – 0.6 cm; CS – brown (7.5YR6/4); CF – brown (7.5YR5/4); SU 427; □ U 27; A – VI; F – 321; T – L5; Fa – VKJ 2
- 51** Fragment of a coarse pot. It was not made on a wheel. Slightly protruding rim with a rounded edge. Rough surface (Pl. 8: 4).  
*dR* – 33 cm; *dN* – 32 cm; WT – 0.8 cm; CS – black (GLE1 3/N); CF – black (GLE1 2.5/N); S – very coarse; SU 427; □ U 27; A – VI; F – 321; T – L8; Fa – VKJ 1
- 52** Fragment of a pot with a protruding rim with a widened edge. Short, cylindrical neck widening into a rounded shoulder. A pot is of poor craftsmanship with rough, coarse surface (Pl. 8: 5).  
 WT – 0.7 cm; CS – brown (7.5YR4/2); CF – dark brown (7.5YR2.5/1); S – coarse; SU 427; □ U 27; A – VI; F – 321; T – L8; Fa – VKJ 24
- 53** Fragment of a pot with an obliquely protruding rim and a slanting shoulder. Slip is not preserved (Pl. 8: 6).  
 WT – 0.6 cm; CS – orange (7.5YR6/4–5YR6/8); CF – gray to orange (5YR5/6–5/1); SU 427; □ U 27; A – VI; F – 321; T – L4?; Fa – VKJ 2
- 54** A flat based plate with slightly thickened inward protruding rim. Slanting walls, uneven firing colour, very small inclusions in the clay. Black slip on the inner wall; presumably so that the vessel could hold liquids (Pl. 8: 7).  
*dR* – 23 cm; *dB* – 16 cm; *hV* – 5.1 cm; WT – 0.6 cm; S – slightly coarse, black slip on the inner surface; CS – outer surface: red (5YR6/4), brown (5YR5/4), black (10YR3/1), inner surface: gray (10YR3/1) firing colour with black slip (2.5Y2.5/1); CF – uneven; D – black slip on the inner surface; SU 427; □ U 27/28; A – VI; F – 338; T – T1; Fa – VKJ 2
- 55** Fragment of a lid with a ring-shaped, but messy, handle. The handle is not hollow. Side walls are slightly curved inward (Pl. 8: 8).  
*hV* – 9.2 on the preserved part; *dH* – 0.35 cm; WT – 0.5 – 1.8 cm; S – slightly coarse; CS – outer surface: dark



(T. 8: 9).

hV – 5,1 cm u očuvanom dijelu; dH – 4,6 cm; WT – 0,9 cm; St – malo hrapava; CS – tamno siva (2,5Y3/1); CF – smeđa (7,5YR5/4); SJ 427; □ U 27; S – VI; N – 321; T – P?; Fa – VKJ 2

- 57.** Ulomak dna posude. Dno je ravno, bočne stijenke se koso šire prema trbuhu. Grube je izrade, bez očuvanog premaza (T. 8: 10).

dB – 10 cm; WT – 0,6 cm; CS – smeđa do siva (7,5YR5/4–10YR5/1); CF – smeđa (7,5YR4/4); SJ 427; □ U 27; S – VI; N – 321; T – ?; Fa – VKJ 2

- 58.** Četiri ulomka dna posude. Dno je ravno, bočne stijenke se koso izdižu prema trbuhu. Posuda je rađena na sporo rotirajućem kolu (T. 8: 11).

dB – 11 cm; WT – 0,5 cm; CS – smeđa do siva (7,5YR6/3–10YR4/1); CF – smeđa (5YR4/6); SJ 427; □ U 27; S – VI; N – 321; T – ?; Fa – VKJ 2

- 59.** Ulomak oboda pompejanskog tanjura. Bočne stijenke su kose, obod je zaobljen, rub je s unutrašnje strane jastučasto zadebljan. Mjestimice je očuvan tamni crveni premaz (T. 8: 12).

WT – 0,6 cm; CS – narančasta (5YR7/4), premaz crven (2,5YR4/8); CF – smeđa (2,5YR5/4); D – tamnocrveni premaz; SJ 427; □ U 27; S – VI; N – 321; T – T2; Fa – 13

- 60.** Ulomak pompejanskog tanjura. Bočne stijenke su ukošene, obod je zaobljen, blago zadebljan (T. 8: 13).

WT – 0,6 cm; CS – narančasta (2,5YR7/4); CF – narančasta (2,5YR5/6); SJ 427; □ U 27; S – VI; N – 321; T – T2; Fa – VKJ 13

### Kompleks 3

#### SJ 76/77

- 61.** Lonac koso izvijenog oboda koji s unutrašnje strane ima crni premaz. Vrat je vrlo kratak i širi se u tijelo sa zaobljenim ramenom koje je neznatno šire od samog oboda. Posuda s vanjske strane ima crni premaz (T. 9: 1). dR – 18 cm; dV – 19,5 cm; dN – 16,4 cm; WT – 0,3 cm; St – hrapava, mjestimice glatka gdje je premaz; CS – vani: smeđa (7,5YR5/2), unutra: tamno smeđa (7,5YR3/1); CF – tamno smeđa (7,5YR3/1); D – crni premaz na obodu s unutrašnje strane i na tijelu posude s vanjske strane; SJ 76; □ Y 28; S – VI, N – 106; T – L3; Fa – VKJ 2

- 62.** Ulomak trakaste drške i oboda posude. Gruba izrada (T. 9: 2).

dH – 1,9 x 0,8 cm; CS – siva (GLEY1 4/N); CF – crna (GLEY1 2,5/N); SJ 76; □ Y 28; S – VI; N – 106; T – L5?; Fa – VKJ 2

- 63.** Ulomak dna uske posude. Dno je ravno, bočne stijenke su blago zaobljene (T. 9: 3).

gray (10YR4/1) to brown (7,5YR5/3), inner surface: black (5Y3/1) to brown (7,5YR6/4); CF – brown (7,5YR6/4); SU 427; □ U 27; A – VI; F – 321; T – P1; Fa – VKJ 2

- 56.** Fragment of a lid with a handle which widens toward its top and has a dent on it; filled in cross-section (Pl. 8: 9).

hV – 5.1 cm on the preserved part; dH – 4.6 cm; WT – 0.9 cm; S – slightly coarse; CS – dark gray (2.5Y3/1); CF – brown (7.5YR5/4); SU 427; A – VI; □ U 27; F – 321; T – P?; Fa – VKJ 2

- 57.** Fragment of the base of a vessel. Flat base; side walls obliquely widening toward the body. Coarse craftsmanship; slip is not preserved (Pl. 8: 10).

dB – 10 cm; WT – 0.6 cm; CS – brown to gray (7.5YR5/4; 10YR5/1); CF – brown (7.5YR4/4); SU – 427; □ U 27; A – VI; F – 321; T – ?; Fa – VKJ 2

- 58.** Four fragments of the base of a vessel. Flat base; side walls obliquely rising toward the body. Vessel made on the slow wheel (Pl. 8: 11).

dB – 11 cm; WT – 0.5 cm; CS – brown to gray (7.5YR6/3–10YR4/1); CF – brown (5YR4/6); SU – 427; □ U 27; A – VI; F – 321; T – ?; Fa – VKJ 2

- 59.** Fragment of the rim of a Pompeian plate. Oblique side walls; rounded rim, thickened and pillow-shaped on the inside. Dark red slip preserved in places (Pl. 8: 12).

WT – 0.6 cm; CS – orange (5YR7/4), red slip (2,5YR4/8); CF – brown (2,5YR5/4); D – dark red slip; SU – 427; □ U 27; A – VI; F – 321; T – T2; Fa – 13

- 60.** Fragment of a Pompeian plate. Oblique side walls; rounded, slightly thickened rim (Pl. 8: 13).

WT – 0.6 cm; CS – orange (2,5YR7/4); CF – orange (2,5YR5/6); SU – 427; □ U 27; A – VI; F – 321; T – T2; Fa – VKJ 13

### Complex 3

#### SU 76/77

- 61.** A pot with an obliquely protruding rim with a black slip on the inside. Short neck which widens into the body with a rounded shoulder which is somewhat wider than the rim itself. Black slip on the outside of the vessel (Pl. 9: 1).

dR – 18 cm; dV – 19.5 cm; dN – 16.4 cm; WT – 0.3 cm; S – coarse, occasionally smooth in places where the slip is preserved; CS – outer surface: brown (7.5YR5/2), inner surface: dark brown (7.5YR3/1); CF – dark brown (7.5YR3/1); D – black slip on the inside of the rim, and on the outer wall of the body; SU 76; □ Y 28; A – VI; F – 106; T – L3; Fa – VKJ 2

- 62.** Fragment of the ribbon-like handle and the rim of a vessel. Coarse craftsmanship (Pl. 9: 2).



*d*B – 7 cm; WT – 0,6 cm; CS – crna (GLE1 3/N); CF – smeđesiva (10R3/1); SJ 76; □ Y 28; S – VI; N – 106; T – ?; Fa – VKJ 2

- 64.** Zdjela ravnog oboda koji je zakošen s unutrašnje strane. Stjenke su blago zaobljene prema vanjskoj strani. S unutrašnje strane nalazi se crni premaz, pa je posuda vjerojatno služila za držanje tekućine (T. 9: 4).

*d*R – 25,2 cm; *d*B – 18 cm; *h*V – 10,9 cm; WT – 0,5–0,9 cm; St – malo hrapava; CS – vani: smeđa (7,5YR5/2) do crvena (5YR6/6), unutra: crna (5Y2,5/1); CF – crna (5Y2,5/1); D – na unutrašnjoj strani crni premaz; SJ 76; □ Y 28; S – VI; PN – 11; T – Z1; Fa – VKJ 2

- 65.** Ulomci donjeg dijela veće posude, vjerojatno lonca grube izrade. Dno je ravno, a bočne stijenke su ukošene (T. 9: 5).

*d*B – 14,2 cm; WT – 0,7–1,2 cm; CS – smeđesiva (10R5/1); CF crna (GLE1 2,5/N); SJ 76; □ Y 28; S – VI; PN – 11; T – ?; Fa – VKJ 22?

#### SJ 104/105

- 66.** Ulomak oboda lonca. Obod je koso izvijen, rame je zaobljeno. Grube je izrade, premaz nije očuvan (T. 9: 7).

*d*R – 16,2 cm; WT – 0,7 cm; CS – smeđa do siva (7,5YR6/3–GLE1 5/N); CF – smeđa do siva (7,5YR5/4–4/1); SJ 104; □ X 27; S – VI; N – 120; T – L3; Fa – VKJ 2

#### SJ 106/107

- 67.** Ulomak lonca koso izvijenog oboda i koso postavljenog ramena. Grube je izrade bez tragova očuvanog premaza. Očuvano je i dno koje vjerojatno pripada istoj posudi. Dno je ravno, bočne stijenke se koso šire prema trbuhu (T. 9: 11a–b).

*d*B – 10 cm; WT – 0,7 cm; CS – CF – smeđa do siva (7,5YR5/4–4/1); SJ 106; □ X 25; S – VI; N – 125; T – L4; Fa – VKJ 2

- 68.** Osam ulomaka vrča ili lonca ukrašenog tamno crvenim slikanjem. Dno je ravno, ukošeno s vanjske strane, očuvan je i dio zaobljenog vrata (T. 9: 12a–b).

*d*B – 6,3 cm; WT – 0,5 cm; CS – tamno crveno (2,5YR5/6), boja crvena (10R 4/6); CF – crveno (10R5/6); D – slikanje tamnocrvenom bojom; SJ 106; □ X 25; S – VI; N – 125; T – ?; Fa – mnogo sitnih primjesa uočljivih tek pod uvećanjem

#### Kompleks 4

##### Zapune ukopa SJ 405

- 69.** Lonac širokog oboda koji je izvijen prema van, obod je zadebljan i u presjeku izgleda plosnato. Vrat je vrlo kratak i prelazi u zaobljeno rame. Posuda na obodu i vanjskoj stijenci ima premaz (T. 10: 1).

*d*R – 17,2 cm; *d*N – 15,6 cm; WT – 0,4 cm tijelo, 0,6 cm

*d*H – 1,9 x 0,8 cm; CS – gray (GLE1 4/N); CF – black (GLE1 2,5/N); SU 76; □ Y 28; S – VI; F – 106; T – L5?; Fa – VKJ 2

- 63** Fragment of the base of a narrow vessel. Flat base; side walls slightly rounded (Pl. 9: 3).

*d*B – 7 cm; WT – 0,6 cm; CS – black (GLE1 3/N); CF – brown to gray (10R3/1); SU 76; □ Y 28; A – VI; F – 106; T – ?; Fa – VKJ 2

- 64** A bowl with a straight rim slanted on the inside. Walls slightly curved outward. Black slip on the inside indicates that the vessel was probably used for storage of liquids (Pl. 9: 4).

*d*R – 25,2 cm; *d*B – 18 cm; *h*V – 10,9 cm; WT – 0,5–0,9 cm; S – slightly coarse; CS – outer surface: brown (7,5YR5/2) to red (5YR6/6), inner surface: black (5Y2,5/1); CF – black (5Y2,5/1); D – black slip on the inner surface; SU 76; □ Y 28; A – VI; SF 11; T – Z1; Fa – VKJ 2

- 65** Fragments of the lower part of a larger vessel, probably a coarse pot. Flat base, slanting side walls (Pl. 9: 5).

*d*B – 14,2 cm; WT – 0,7–1,2 cm; CS – brown to gray (10R5/1); CF – black (GLE1 2,5/N); SU 76; □ Y 28; A – VI; SF – 11; T – ?; Fa – VKJ 22?

#### SU 104/105

- 66** Fragment of the rim of a pot. Obliquely protruding rim; rounded shoulder. Coarse craftsmanship; slip is not preserved (Pl. 9: 7).

*d*R – 16,2 cm; WT – 0,7 cm; CS – brown to gray (7,5YR6/3–GLE1 5/N); CF – brown to gray (7,5YR5/4–4/1); SU – 104; □ X 27; A – VI; F – 120; T – L3; Fa – VKJ 2

#### SU 106/107

- 67** Fragment of a pot with an obliquely protruding rim and slanting shoulder. Coarse craftsmanship without traces of slip. A base is preserved which probably belongs to the same vessel. Flat base; side walls obliquely widen toward the body (Pl. 9: 11a–b).

*d*B – 10 cm; WT – 0,7 cm; CS – CF – brown to gray (7,5YR5/4–4/1); SU – 106; □ X 25; A – VI; F – 125; T – L4; Fa – VKJ 2

- 68** Eight fragments of a jug or a pot with dark red painted decorations. Flat base, slanted to the outside; part of a rounded neck is also preserved (Pl. 9: 12a–b).

*d*B – 6,3 cm; WT – 0,5 cm; CS – dark red (2,5YR5/6), red (10R 4/6); CF – red (10R5/6); D – painted with dark red paint; SU 106; □ X 25; A – VI; F 125; T – ?; F – many tiny inclusions visible only under magnifier

#### Complex 4

##### Backfills of SU 405

- 69** A pot with a wide outward protruding rim which is thickened and flat in cross-section. Very short neck that



vrat; St – glatka; CS – smeđa (10YR6/3); CF – smeđa (10YR6/3) do crna u sredini (10YR2/1); SJ 404; □ K/L 29/30; S – VII; N – 294; T – L2; Fa – VKJ 2

- 70.** Lonac zaobljenog oboda izvijenog prema van. Vrat je vrlo kratak i odmah prelazi u rame. Na posudi nema ukrasa, a premaz je slabo sačuvan (T. 10: 2).

*dR* – 17 cm; *dN* – 16 cm; WT – 0,4–0,5 cm; St – malo hrapava; CS – tamno smeđa (7,5YR5/2); CF – tamno siva (7,5YR4/1); SJ 499; □ K/L 29/30; S – VII; N – 317; T – L2; Fa – VKJ 2

- 71.** Lonac kratkog i širokog oboda koji je kružno zaobljen i malo izvijen prema van. Vrat je jedva naglašen, a tijelo se dosta širi u odnosu na obod. Na vanjskoj stijenci loše je sačuvan premaz. Posuda je rađena na kolu (T. 10: 3).

*dR* – 17 cm; *dV* – više od 21 cm; *dN* – 16,7 cm; WT – 0,4–0,6 cm (tijelo ima tanje stjenke koje se debljaju prema vratu i obodu); St – zaglađena; CS – smeđa (10YR5/3); CF – smeđa (10YR5/3–3/1) tamnija je prema vanjskoj stijenci; D – na obodu i vanjskoj stijenci tragovi smeđeg premaza; SJ 404; □ K/L 29/30; S VII; N – 294; T – L2; Fa – VKJ 2

- 72.** Lonac s obodom koji je izvijen prema van, kružno je zaobljen i zadebljan. Vrat je kratak, s unutrašnje strane naglašen je prijelaz u zaobljeno rame. Tijelo se jako širi, a stjenke su tanje nego na vratu i obodu. Na obodu su sačuvani tragovi premaza. Obod i vanjska stjenka bili su zaglađeni (T. 10: 4).

*dR* – 18 cm; *dV* – >21,5 cm; *dN* – 16,5 cm; WT – 2 mm tijelo, 5,5 mm vrat i obod; St – zaglađena, neravna; CS – vani: smeđa (10YR5/3), unutra: smeđa (10YR5/3) do crna (2,5Y3/1); CF – tamno siva (10YR3/1); SJ 499; □ K/L 29/30; S – VII; N – 317; T – L2; Fa – VKJ 2

- 73.** Lonac sa zaobljenim obodom izvijenim prema van. Obod i vrat imaju nešto deblju stjenku od tijela. Vrat je kratak. Na obodu se nalazi crni premaz s unutrašnje strane, a na vanjskoj stijenci lonca smeđi (T. 10: 5).

*dR* – 15 cm; *dN* – 13,9 cm; WT – 0,6 cm obod, 0,3 cm tijelo; St – zaglađena; CS – vani: tamno siva (2,5Y3/1), unutra: crna (5YR2,5/1), smeđa (7,5YR5/2); CF – crna (5YR2,5/1); D – premaz na obodu i vanjskoj stijenci; SJ 404; □ K/L 29/30; S – VII; N – 294; T – L2; Fa – VKJ 2

- 74.** Lonac izrađen na kolu sa zaobljenim obodom koji je izvijen prema van. Stjenka oboda i vrata su deblje od stjenke tijela lonca. Prijelaz vrata u rame je naglašen jedva vidljivom vodoravnom linijom, a rame je zaobljeno. Posuda ima premaz (T. 10: 6).

*dR* – 15 cm; *dN* – 14 cm; WT – 0,2 cm tijelo, 0,4 cm obod i vrat; St – zaglađena; CS – tamno siva (2,5Y3/1); CF – tamno siva (2,5Y3/1) do smeđa (7,5YR6/6); SJ 404; □ K/L

exceeds into a rounded shoulder . Slip on the rim and the outer wall of the vessel (Pl. 10: 1).

*dR* – 17.2 cm; *dN* – 15.6 cm; WT – 0.4 cm body, 0.6 cm neck; S – smooth; CS – brown (10YR6/3); CF – brown (10YR6/3) to black in the middle (10YR2/1); SU 404; □ K/L 29/30; A – VII; F – 294; T – L2; Fa – VKJ 2

- 70** A pot with an outward protruding, rounded rim. Very short neck immediately exceeding into the shoulder. There are no decorations on the vessel and slip is poorly preserved (Pl. 10: 2).

*dR* – 17 cm; *dN* – 16 cm; WT – 0.4–0.5 cm; S – slightly coarse; CS – dark brown (7.5YR5/2); CF – dark gray (7.5YR4/1); SU 499; □ K/L 29/30; A – VII; F – 317; T – L2; Fa – VKJ 2

- 71** A pot with a short and wide, rounded and slightly outward protruding rim. The neck is hardly emphasized, and the body widens considerably with regard to the rim. Poorly preserved slip on the outside wall. Vessel is made on the wheel (Pl. 10: 3).

*dR* – 17 cm; *dV* – more than 21 cm; *dN* – 16.7 cm; WT – 0.4–0.6 cm (walls of the body are thinner than the walls of the neck and the rim); S – smoothed; CS – brown (10YR5/3); CF – brown (10YR5/3–3/1) darker towards the outer surface; D – on the rim and the outer surface the remains of brown slip; SU 404; □ K/L 29/30; A – VII; F – 294; T – L2; Fa – VKJ 2

- 72** A pot with an outward protruding, rounded and thickened rim. Short neck, with transition to the neck emphasized on the inside. The body widens considerably and its walls are thinner than on the neck and the rim. Traces of slip preserved on the rim. The rim and the outer walls were smoothed (Pl. 10: 4).

*dR* – 18 cm; *dV* – larger than 21.5 cm; *dN* – 16.5 cm; WT – 2 mm body, 5.5 mm the neck and the rim; S – smoothed, uneven; CS – outer surface: brown (10YR5/3), inner surface: brown (10YR5/3) to black (2.5Y3/1); CF – dark gray (10YR3/1); SU 499; □ K/L 29/30; A – VII; F – 317; T – L2; Fa – 2

- 73** A pot with a rounded, outward protruding rim. Walls thicker on the rim and the neck. Short neck. Black slip on the inside of the rim, a brown on the outside of the vessel (Pl. 10: 5).

*dR* – 15 cm; *dN* – 13.9 cm; WT – 0.6 cm rim, 0.3 cm body; S – smoothed; CS – outer surface: dark gray (2.5Y3/1), inner surface: black (5YR2.5/1), brown (7.5YR5/2); CF – black (5YR2.5/1); D – slip on the rim and the outer surface; SU 404; K/L 29/30; A – VII; F – 294; T – L2; Fa – VKJ 2

- 74** A pot made on the wheel with a rounded, outward protruding rim. Walls of the rim and the neck are thicker than the walls of the body of the pot. The transition



29/30; S – VII; N – 294; T – L2; Fa – VKJ 2

- 75.** Lonac širokog oboda koji je izvijen prema van i vrlo blago je zaobljen. Vrat je kratak i prelazi u blago zaobljeno rame. Na vanjskoj stijenci ima premaz (T. 10: 7).

$dR$  – 14 cm;  $dN$  – 13,5 cm; WT – 0,3–0,6 mm, stjenka je deblja na tijelo, širi se prema vratu i obodu; St – hrpava, premaz je oguljen; CS – vani: crvena (7,5YR5/4) boja pečenja i smeđi (7,5YR5/2) premaz, unutra: crvena (7,5YR6/6); CF – smeđa (7,5YR5/6); D – premaz s obje strane; SJ 404; □ K/L 29/30; S – VII; N – 294; T – L2; Fa – VKJ 2

- 76.** Lonac čiji je obod izvijen prema van, vrat je kratak, odnosno naglašen je naglim prijelazom u rame. S unutrašnje strane posuda je crne boje s tragovima gara, dok ih s vanjske strane nema. Na posudi ima vrlo malo sačuvanog premaza na vanjskoj stijenci. Ispod oboda na unutrašnjoj stijenci očuvani su otisci prstiju lončara nastali prilikom dodavanja gline za obod lonca (T. 10: 8).

$dR$  – 16 cm;  $dN$  – 14,5 cm; WT – 0,47 cm; St – malo hrpava; CS – vani: neujednačena boja, svijetlo smeđa (7,5YR6/4) do crna (7,5YR4/1), unutra: crna (7,5YR2,5/1); CF – crna (7,5YR2,5/1); SJ 497; □ K/L 29/30; S – VII, N – 318; T – L3; Fa – VKJ 2

- 77.** Lonac s kosim obodom izvijenim prema van, a njegov rub je ravan. Stjenke oboda su deblje od stijenci tijela posude. Vrat je vrlo kratak, a mjestimično je sačuvan premaz (T. 10: 9).

$dR$  – 16 cm;  $dV$  – oko 18 cm;  $dN$  – 14,7 cm; WT – 0,2–0,5 cm; St – hrpava; CS – smeđa (7,5YR6/4); CF – smeđa (7,5YR6/4); SJ 499; □ K/L 29/30; S – VII; N – 317; T – L3; Fa – VKJ 2

- 78.** Lonac s obodom koji je koso izvijen prema van, ima kratki vrat koji prelazi u zaobljeno rame i trbuh koji je samo neznatno širi od oboda. Na obodu s unutrašnje strane i na vanjskoj stijenci nalazi se premaz od tamno-sive boje koji je loše sačuvan (T. 10: 10).

$dR$  – 14 cm;  $dV$  – 15,5 cm;  $dN$  – 12,8 cm; WT – 0,3–0,4 cm; St – glatka; CS – tamno siva (10YR4/1); CF – tamno siva (10YR4/1); SJ 509; □ K/L 29/30; S – VII; N – 323; T – L3; Fa – VKJ 2

- 79.** Lonac širokog oboda rađen na kolu. Obod je koso izvijen prema van i ima oštre bridove. Vrat je kratak, rame je zaobljeno, a na obodu i vanjskoj stijenci slabo sačuvan premaz (T. 10: 11).

$dR$  – 19 cm;  $dN$  – 18,2 cm; WT – 0,6 cm; St – zaglađena; CS – vani: smeđe siva (10YR4/1); unutra: smeđa (10YR6/4); CF – siva (10YR4/1); D – smeđi premaz na obodu i vanjskoj stijenci; SJ 404; □ K/L 29/30; S – VII; N – 294;

from the neck to the shoulder is emphasized by a barely visible horizontal line, and the shoulder is rounded. The vessel has a slip (Pl. 10: 6).

$dR$  – 15 cm;  $dN$  – 14 cm; WT – 0.2 cm body, 0,4 cm rim and neck; S – smoothed; CS – dark gray (2.5Y3/1); CF – dark gray (2.5Y3/1) to brown (7.5YR6/6); SU 404; □ K/L 29/30; A – VII; F – 294; T – L2; Fa – VKJ 2

- 75** A pot with a wide, obliquely protruding, slightly rounded rim. Short neck which exceeds into a slightly rounded shoulder. Slip on the outer wall (Pl. 10: 7).

$dR$  – 14 cm;  $dN$  – 13.5 cm; WT – 0.3–0.6 mm, the wall is thicker towards the neck and the rim; S – coarse, the slip is peeled; CS – outer surface: red (7.5YR5/4) firing colour and brown (7.5YR5/2) slip, inner surface: red (7.5YR6/6); CF – brown (7.5YR5/6); D – slip on both surfaces; SU 404; □ K/L 29/30; A – VII; F – 294; T – L2; Fa – VKJ 2

- 76** A pot with an outward protruding rim and a short neck emphasized by an abrupt transition to the neck. The vessel is black with traces of soot on the inside, while there are none on the outside. Poorly preserved slip on the outside of the vessel. Fingertips of the potter, incurred when the clay was added, are preserved on the inside, below the rim (Pl. 10: 8).

$dR$  – 16 cm;  $dN$  – 14.5 cm; WT – 0.47 cm; S – slightly coarse; CS – outer surface: the colour is uneven, light brown (7.5YR 6/4) to black (7.5YR4/1), inner surface: black (7.5YR2.5/1); CF – black (7.5YR2.5/1); SU 497; □ K/L 29/30; A – VII, F – 318; T – L3; Fa – VKJ 2

- 77** A pot with an oblique, outward protruding rim with a straight edge. Walls of the rim are thicker than the walls of the body of the vessel. Very short neck; slip preserved in places (Pl. 10: 9).

$dR$  – 16 cm;  $dV$  – around 18 cm;  $dN$  – 14.7 cm; WT – 0.2–0.5 cm; S – coarse; CS – brown (7.5YR6/4); CF – brown (7.5YR6/4); SU 499; □ K/L 29/30; A – VII; F – 317; T – L3; Fa – VKJ 2

- 78** A pot with an obliquely outward protruding rim, a short neck which exceeds to the rounded shoulder and the body which is only slightly wider than the rim itself. Poorly preserved dark gray slip on the inside of the rim and on the outer wall (Pl. 10: 10).

$dR$  – 14 cm;  $dV$  – 15.5 cm;  $dN$  – 12.8 cm; WT – 0.3–0.4 cm; S – smooth; CS – dark gray (10YR4/1); CF – dark gray (10YR4/1); SU 509; □ K/L 29/30; A – VII; F – 323; T – L3; Fa – VKJ 2

- 79** A pot with a wide rim, made on the wheel. Obliquely outward protruding rim with sharp edges. Short neck; rounded shoulder; poorly preserved slip on the rim and on the outer wall (Pl. 10: 11).

$dR$  – 19 cm;  $dN$  – 18.2 cm; WT – 0.6 cm; S – smoothed; CS



T – L3; Fa – VKJ 2

- 80.** Lonac širokog oboda koji je koso izvijen prema van. Vrat je naglašen na način da se na njemu lomi posuda iz oboda u tijelo koje se koso širi. Posuda je imala premaz s vanjske i unutrašnje strane (T. 10: 12).

*dR* – 16 cm; *dV* – >18 cm; *dN* – 14,4 cm; *WT* – 0,4–0,6 cm (stjenke trbuha su tanje od oboda i vrata); *St* – glatka; *CS* – vani: siva (10YR4/1), unutra: crna (5Y2,5/1); *CF* – siva (10YR4/1); *SJ* 404; □ K/L 29/30; *S* – VII; *N* – 294; *T* – L4; *Fa* – VKJ 2

- 81.** Trakasto oblikovana drška. Blago profilirana. Pripadala je loncu s dvije drške ili vrču (T. 10: 13).

*dH* – 3,1 x 2,6 cm; *CS* – smeđa (7,5YR6/4); *CF* – smeđa (7,5YR5/6); *SJ* 404; □ K/L 29/30; *S* – VII; *N* – 294; *T* – L5?; *Fa* – VKJ 2

- 82.** Trakasto oblikovana drška. Blago profilirana. Pripadala je loncu s dvije drške ili vrču (T. 10: 14).

*dH* – 2,5 x 1,2 cm; *CS* – smeđa (7,5YR7/4); *CF* – smeđa do siva (7,5YR5/2–10YR4/1); *SJ* 404; □ K/L 29/30; *S* – VII; *N* – 294; *T* – L5?; *Fa* – VKJ 2

- 83.** Trakasto oblikovana drška. Blago profilirana. Pripadala je loncu s dvije drške ili vrču (T. 10: 15).

*dH* – 3,1 x 1,6 cm; *CS* – smeđa (10YR7/3–7/2); *CF* – smeđa (7,5YR4/3); *SJ* 404; □ K/L 29/30; *S* – VII; *N* – 294; *T* – L5; *Fa* – VKJ 2

- 84.** Trakasto oblikovana drška. Blago profilirana. Pripadala je loncu s dvije drške ili vrču (T. 10: 16).

*dH* – 3,2 x 1,4 cm; *CS* – smeđa (7,5YR5/3); *CF* – tamnosmeđa (7,5YR2,5/1); *SJ* 404; □ K/L 29/30; *S* – VII; *N* – 294; *T* – L5?; *Fa* – VKJ 2

- 85.** Ulomci oboda i dna velikog lonca. Posuda je vrlo grube i nepravilne izrade. Obod je negdje trokutast u presjeku, a negdje je samo koso izvijen. Dno je ravno i nepravilno (T. 11: 1).

*dR* – 36 cm; *dB* – 22 cm; *WT* – 0,8–1 cm; *CS* – smeđa (7,5YR5/2); *CF* – (7,5YR3/1); *SJ* 499; □ K/L 29/30; *S* – VII; *N* – 317; *T* – L?; *Fa* – VKJ 14

- 86.** Tanjur ravnog dna i oboda. Stjenke posude su kose, a na unutrašnjoj strani nalazi se crni premaz koji se mrviti otpada (T. 11: 2).

*dR* – 22 cm; *dB* – 16,1 cm; *hV* – 5,3 cm; *WT* – 0,7 cm tijelo, 0,2 cm dno; *St* – hrapava, bez posebne obrade; *CS* – vani: crvena (5YR5/6) do tamno siva (5YR3/1), unutra: tamno siva (5YR3/1); *CF* – tamno siva (5YR3/1); *D* – premaz na unutrašnjoj strani; *SJ* 404; □ K/L 29/30; *S* – VII; *N* – 294; *T* – T1; *Fa* – VKJ 2

- 87.** Posuda ravnog dna, jako zakošenih stijenki i blago

– outer surface: brown to gray (10YR4/1); inner surface: brown (10YR6/4); *CF* – gray (10YR4/1); *D* – brown slip on the rim and the outer surface; *SU* 404; □ K/L 29/30; *A* – VII; *F* – 294; *T* – L3; *Fa* – VKJ 2

- 80** A pot with a wide, obliquely outward protruding rim. The neck is emphasized by a transition from the rim into the obliquely widening body. Slip on the outside and on the inside (Pl. 10: 12).

*dR* – 16 cm; *dV* – larger than 18 cm; *dN* – 14.4 cm; *WT* – 0.4–0.6 cm (walls of the body are thinner than the walls of the rim and the neck); *S* – smooth; *CS* – outer surface: gray (10YR4/1), inner surface: black (5Y2.5/1); *CF* – gray (10YR4/1); *SU* 404; □ K/L 29/30; *A* – VII; *F* – 294; *T* – L4; *Fa* – VKJ 2

- 81** Ribbon-like handle. Slightly profiled. It was a part of a pot with two handles or a jug (Pl. 10: 13).

*dH* – 3.1 x 2.6 cm; *CS* – brown (7.5YR6/4); *CF* – brown (7.5YR5/6); *SU* 404; □ K/L 29/30; *A* – VII; *F* – 294; *T* – L5?; *Fa* – VKJ 2

- 82** Ribbon-like handle. Slightly profiled. It was a part of a pot with two handles or a jug (Pl. 10: 14).

*dH* – 2.5 x 1.2 cm; *CS* – brown (7.5YR7/4); *CF* – brown to gray (7.5YR5/2–10YR4/1); *SU* 404; □ K/L 29/30; *A* – VII; *F* – 294; *T* – L5?; *Fa* – VKJ 2

- 83** Ribbon-like handle. Slightly profiled. It was a part of a pot with two handles or a jug (Pl. 10: 15).

*dH* – 3.1 x 1.6 cm; *CS* – brown (10YR7/3–7/2); *CF* – brown (7.5YR4/3); *SU* 404; □ K/L 29/30; *A* – VII; *F* – 294; *T* – L5; *Fa* – VKJ 2

- 84** Ribbon-like handle. Slightly profiled. It was a part of a pot with two handles or a jug (Pl. 10: 16).

*dH* – 3.2 x 1.4 cm; *CS* – brown (7.5YR5/3); *CF* – dark brown (7.5YR2.5/1); *SU* 404; □ K/L 29/30; *A* – VII; *F* – 294; *T* – L5?; *Fa* – VKJ 2

- 85** Fragments of the rim and the base of a large pot. Very coarse and poor craftsmanship. The rim in places has a triangular cross-section, and in places it is only obliquely protruding. Flat and irregular base (Pl. 11: 1).

*dR* – 36 cm; *dB* – 22 cm; *WT* – 0.8–1 cm; *CS* – brown (7.5YR5/2); *CF* – (7.5YR3/1); *SU* 499; □ K/L 29/30; *A* – VII; *F* – 317; *T* – L?; *Fa* – VKJ 14

- 86** A plate with a flat base and a straight rim. Slanting walls; black slip, which started to peel, on the inside (Pl. 11: 2).

*dR* – 22 cm; *dB* – 16.1 cm; *hV* – 5.3 cm; *WT* – 0.7 cm body, 0.2 cm base; *S* – coarse with no additional treatment; *CS* – outer surface: red (5YR5/6) to dark gray (5YR3/1), inner surface: dark gray (5YR3/1); *CF* – dark gray (5YR3/1); *D* – slip on the inner side; *SU* 404; □ K/L



- zadebljalog oboda naglašenog prema unutra. Tanjur ima neujednačenu boju pečenja, a s unutrašnje strane imalo je crni premaz pa se pretpostavlja da se u njemu držala tekućina (T. 11: 3).  
*dR* – 24 cm; *dB* – 13,9 cm; *hV* – 6,9 cm; *WT* – 0,6 cm; *St* – pomalo hrapava, unutrašnja strana ima premaz i tu je glatka; *CS* – vani: crvena (5YR6/4), smeđa (5YR5/4), crna (10YR3/1), unutra: smeđa (7,5YR4/2), siva (10YR3/1) boja pečenja s crnim premazom (2,5Y2,5/1); *CF* – neujednačena; *D* – unutrašnja strana ima crni premaz, SJ 404–499; □ K/L 29/30; *S* – VII; *N* – 261, 302, 317; *T* – T2; *Fa* – VKJ 2
- 88.** Poklopac čiji je obod blago izvijen prema van, a stijenke su blago utisnute prema unutra. Na unutrašnjoj stijenci nalaze se tragovi gara (T. 11: 4).  
*dR* – 22 cm; *WT* – 0,6 cm; *St* – neravna; *CS* – vani: crvena (2,5YR5/4) do tamno siva (10YR3/14), unutra: tamno siva (2,5YR2/1); *CF* – siva (2,5YR2/1); SJ 497; □ K/L 29/30; *S* – VII; *N* – 318; *T* – P1; *Fa* – VKJ 2
- 89.** Posuda koja je mogla služiti kao poklopac (zbog oblika), ali i kao tanjur (zbog premaza na vanjskoj i unutrašnjoj strani). Obod je ravan, a stijenke se koso spuštaju i nisu zaobljene. Premaz je smeđe boje na vanjskoj strani, a na unutrašnjoj crne. Ukoliko je ovaj predmet služio kao tanjur onda je mogao služiti iz a serviranje tekuće hrane zbog premaza (T. 11: 5).  
*dR* – 19,7 cm; *hV* – 3,6 cm u sačuvanom dijelu; *WT* – 0,6 cm; *St* – hrapava, s unutrašnje strane crni premaz, s vanjske smeđi; *CS* – vani: crvena (2,5YR6/6) boja pečenja, i smeđi (7,5YR6/3) premaz, unutra: crna (5Y2,5/1); *CF* – crna (5Y2,5/1) prema vanjskoj stijenci, crvena (2,5YR6/6) prema unutrašnjoj; *D* – premaz na vanjskoj i unutrašnjoj stijenci; SJ 404; □ K/L 29/30; *S* – VII; *N* – 294; *T* – P2; *Fa* – VKJ 2
- 90.** Obod je ravan, malo uvučen prema unutra. Stijenke se jako koso spuštaju pa se čini da se radi o poklopcu, ali kako se s unutrašnje strane nalazi premaz moguće je da se radi o tanjuru u kojem se servirala tekućina. Moguće je da je posuda služila i kao tanjur, i kao poklopac (T. 11: 6).  
*dR* – 22,8 cm; *hV* – u sačuvanom dijelu 2,9 cm; *WT* – 0,55–0,65 cm; *St* – hrapava, s unutrašnje strane ima premaz; *CS*: vani: smeđa (10YR4/2), unutra: smeđa (10YR4/2) do crna (5Y2,5/1); *CF* – smeđa (10YR4/2) do crna (5Y2,5/1); *D* – s unutrašnje strane ima tragove crnog premaza; SJ 404; □ K/L 29/30; *S* – VI; *N* – 294; *T* – P3; *Fa* – VKJ 2
- 91.** Zdjela s vodoravno izvijenim i profiliranim obodom. S unutrašnje strane prijelaz oboda u bočne stijenke naglašen je uskim rebrom, sami rub oboda je ukrašen 29/30; *A* – VII; *F* – 294; *T* – T1; *Fa* – VKJ 2
- 87** Flat based vessel, with strongly slanting walls and slightly thickened, inward protruding rim. Firing colour is uneven, and there was a black slip on the inside which indicates that the vessel was used for storing liquids (Pl. 11: 3).  
*dR* – 24 cm; *dB* – 13.9 cm; *hV* – 6.9 cm; *WT* – 0.6 cm; *S* – slightly coarse, inner surface: smooth in places where slip is preserved; *CS* – outer surface: red (5YR6/4), brown (5YR5/4), black (10YR3/1), inner surface: brown (7.5YR4/2), gray (10YR3/1) colour of the firing with black slip (2.5Y2.5/1); *CF* – uneven; *D* – inner surface with black slip; SU 404–499; □ K/L 29/30; *A* – VII; *F* – 261, 302, 317; *T* – T2; *Fa* – VKJ 2
- 88** A lid with a slightly outward protruding rim. Traces of soot on the inside (Pl. 11: 4).  
*dR* – 22 cm; *WT* – 0.6 cm; *S* – uneven; *CS* – outer surface: red (2.5YR5/4) to dark gray (10YR3/14), inner surface: dark gray (2.5YR2/1); *CF* – gray (2.5YR2/1); SU 497; □ K/L 29/30; *A* – VII; *F* – 318; *T* – P1; *Fa* – VKJ 2
- 89** A vessel which could have been used as a lid (due to its shape), as well as a plate (due to the slip on the inner and on the outer walls). Straight rim; walls slanting and not rounded. Slip is brown on the outside and black on the inside. If this object was used as a plate it could have been used for serving liquid foods due to the slip (Pl. 11: 5).  
*dR* – 19.7 cm; *hV* – 3.6 cm on the preserved part; *WT* – 0.6 cm; *S* – coarse, inner surface: black slip, outer surface: brown slip; *CS* – outer surface: red (2.5YR6/6) firing colour and brown (7.5YR6/3) slip, inner surface: black (5Y2.5/1); *CF* – black (5Y2.5/1) towards the outer surface, red (2.5YR6/6) towards the inner surface; *D* – slip on both surfaces; SU 404; □ K/L 29/30; *A* – VII; *F* – 294; *T* – P2; *Fa* – VKJ 2
- 90** Straight, slightly inward protruding rim. Walls are slanting so it looks like it was a lid but since there was slip on the inside it could have been a plate used for serving liquid foods. The vessel could have been used both as a plate and as a lid (Pl. 11: 6).  
*dR* – 22.8 cm; *hV* – on the preserved part 2.9 cm; *WT* – 0.55–0.65 cm; *S* – coarse, slip on the inner surface; *CS* – outer surface: brown (10YR4/2), inner surface: brown (10YR4/2) to black (5Y2.5/1); *CF* – brown (10YR4/2) to black (5Y2.5/1); *D* – inner surface: traces of black slip; SU 404; □ K/L 29/30; *S* – VI; *F* – 294; *T* – P3; *Fa* – VKJ 2
- 91** A bowl with a horizontally protruding and profiled rim. Transition from the rim into the side walls is emphasized by a narrow rim on the inside, and the rim itself is decorated by a somewhat wider rib with a row of shal-





nešto širim rebrom u kojeg je plitko utisnut ovalni ukras u nizu. Unutrašnja strana posude prekrivena je mnoštvom manjih rupica (manje od 1 mm) u kojima su sačuvani tragovi glazure (T. 11: 7).

dR – 27 cm; hV – 3,5 u sačuvanom dijelu; WT – 0,6 cm; St – hrapava; CS – vani: siva (7,5YR5/1), unutra: siva (7,5YR5/1) i svijetlo smeđa (7,5YR7/4); CF – siva (7,5YR5/1); D – obod je profiliran, a njegov rub je ukrašen ovalnim ubodima; SJ 404; □ K/L 29/30; S – VII; N – 294; T – Z3; Fa – VKJ 2

- 92.** Ulomak oboda i vrata posude. Posuda ovakve profilacije nije zabilježena na lokalitetu s drugim primjerima. Riječ je vjerojatno, o ulomku vrča (T. 11: 8).

dR – 10 cm; dN – 9,7 cm; WT – 0,7 cm; CS – smeđa (7,5YR6/4); CF – smeđa (7,5YR5/6); SJ 404; □ K/L 29/30; S – VII; N – 294; T – ?; Fa – VKJ 2

- 93.** Ulomak oboda tarionika. Na unutrašnjoj strani djelomice su sačuvani kamenčići utisnuti u glinu s glazurom zeleno maslinaste boje. Obod je jako izvijen prema van i zadebljan je. Prijelaz oboda u tijelo na unutrašnjoj strani naglašen je laganim plastičnim rebrom (T. 12: 1).

WT – 1 cm; St – glatka, na unutrašnjoj strani ogrubljena kamenčićima i ima glazuru; CS – vani: crvena, (5YR7/6), unutra: crvena, (5YR7/6), zeleno maslinasta (5Y6/4); CF – crvena (5YR7/6); D – glazura na unutrašnjoj stijenci; SJ 404; □ K/L 29/30; S – VII; N – 294; T – Tr3; Fa – VKJ 16

- 94.** Ulomak dna tarionika. Dno je ravno, bočne stijenske su ukošene. Unutrašnjost je prekrivena kamenčićima između kojih je djelomično očuvana maslinastozelena glazura (T. 12: 2).

dB – 7 cm; WT – 0,5–0,9 cm; CS – crvena (2,5YR6/8); CF – narančasta do siva (2,5YR5/6–6/2); D – tragovi zelenomaslinaste glazure na unutrašnjoj stijenci; SJ 499; □ K/L 29/30; S – VII; N – 317; T – Tr?; Fa – VKJ 17

- 95.** Dva ulomka zelenoglaziranog tarionika. Očuvane su bočne stijenske. Na unutrašnjoj strani nalaze s vrlo mali kamenčići prekriveni dosta oštećenom maslinastozeleonom glazurom (T. 12: 3).

WT – 0,9 cm; CS – narančasta (7,5YR7/6); CF – sivo do narančasta (5YR6/8–6/1); D – zelenomaslinasta glazura na unutrašnjoj stijenci; SJ 404; □ K/L 29/30; S – VII; N – 294; T – Tr?; Fa – VKJ 16

- 96.** Ulomak glaziranog tarionika. Očuvan je ulomak bočne stijenske (T. 12: 4).

WT – 0,6 cm; CS – narančasta (5YR7/8); CF – narančasta do siva (5YR7/6–5/2); D – zelenomaslinasta glazura na unutrašnjoj stijenci; SJ 404; □ K/L 29/30; S – VII; N – 299; T – Tr?; Fa – VKJ 16

low incised oval decorations. The inner side of the vessel is covered by multitude of small holes (smaller than 1 mm) in which traces of glaze are preserved (Pl. 11: 7). dR – 27 cm; hV – 3.5 on the preserved part; WT – 0.6 cm; S – coarse; CS – outer surface: gray (7.5YR5/1), inner surface: gray (7.5YR5/1) and light brown (7.5YR7/4); CF – gray (7.5YR5/1); D – profiled rim, the edge is decorated with oval impressions; SU 404; □ K/L 29/30; S VII; F 294; T – Z3; Fa – VKJ 2

- 92** Fragment of the rim and the neck of a vessel. A vessel with such profilation has not yet been noted on a site with other types. It is probably a part of a jug (Pl. 11: 8). dR – 10 cm; dN – 9.7 cm; WT – 0.7 cm; CS – brown (7.5YR6/4); CF – brown (7.5YR5/6); SU 404; □ K/L 29/30; A VII; F 294; T – ?; Fa – VKJ 2

- 93** Fragment of the rim of a mortar. Partly preserved pebbles incised in clay with an olive-green glaze preserved on the inside. Strongly outward protruding thickened rim. Transition from the rim into the body is emphasized on the inside by a light plastic rib (Pl. 12: 1). WT – 1 cm; S – smooth, inner surface: glazed and roughened with small pebbles; CS – outer surface: red, (5YR7/6), inner surface: red (5YR7/6), olive-green (5Y6/4); CF – red (5YR7/6); D – glaze on the inner surface; SU 404; □ K/L 29/30; A – VII; F – 294; T – Tr3; Fa – VKJ 16

- 94** Fragment of the base of a mortar. Flat base, slanting side walls. the inside is covered by small pebbles between which an olive-green glaze is partly preserved (Pl. 12: 2).

dB – 7 cm; WT – 0.5–0.9 cm; CS – red (2.5YR6/8); CF – orange to gray (2.5YR5/6–6/2); D – traces of olive-green glaze on the inner surface; SU 499; □ K/L 29/30; A – VII; F – 317; T – Tr?; aF – VKJ 17

- 95** Two fragments of a green-glazed mortar. Side walls preserved. Very small pebbles on the inside, covered with severely damaged olive-green glaze (Pl. 12: 3). WT – 0.9 cm; CS – orange (7.5YR7/6); CF – gray to orange (5YR6/8–6/1); D – olive-green on the inner surface; SU 404; □ K/L 29/30; A – VII; F – 294; T – Tr?; Fa – VKJ 16

- 96** Fragment of side wall of a glazed mortar (Pl. 12: 4). WT – 0.6 cm; CS – orange (5YR7/8); CF – orange to gray (5YR7/6–5/2); D – olive-green glaze on the inner surface; SU 404; □ K/L 29/30; A – VII; F – 299; T – Tr?; Fa – VKJ 16

- 97** Fragment of a massive, profiled handle of a jug. It can be assumed that it was not locally produced (Pl. 12: 5). dH – 4.9 x 2.9 cm; CS – orange (5Y7/6); CF – brown (5YR5/3); SU 499; □ K/L 29/30; A – VII; F – 317; T – amphorae with a flat base/flagon; Fa – VKJ 17



- 97.** Ulomak masivne i profilirane drške vrča. Pretpostavljam da nije lokalni proizvod (T. 12: 5).  
dH – 4,9 x 2,9 cm; CS – narančasta (5Y7/6); CF – smeđa (5YR5/3); SJ 499; □ K/L 29/30; S – VII; N – 317; T – amfora ravnog dna/vrč; Fa – VKJ 17
- 98.** Ulomak sivo pečene posude, lonca ili vrča. Očuvana je bočna, ukošena stijenka (T. 12: 6).  
WT – 0,5–0,7 cm; CS – siva (GLE Y1 4/N–2,5Y7/1); CF – siva (2,5Y6/1); D – uski vodoravni, plitki žlijebovi; SJ 499; □ K/L 29/30; S – VII; N – 261; T – ?; Fa – VKJ 4
- 99.** Ulomak sivo pečene posude, vrča ili lonca. Očuvan je ulomak bočne stijenke (T. 12: 7).  
WT – 0,5 cm; CS – siva (2,5Y5/1); CF – siva (2,5Y5/2); D – nepravilni plitki, paralelni žlijebovi; SJ 499; □ K/L 29/30; S – VII; N – 261; T – ?; Fa – VKJ 4
- Kompleks 5**  
**SJ 244/245**
- 100.** Oboda zdjele. Bočne stijenke su blago zaobljene, obod je ispupčen prema vanjskoj strani. Riječ je o panonskoj imitaciji Drag. 37 zdjele. Na unutrašnjoj i vanjskoj stijenci nalaze se ostaci crvenog premaza (T. 14: 1).  
WT – 0,6 cm; CS – narančasta do crvena (5YR7/3–2,5YR5/8); CF – smeđa (2,5YR5/4); D – crveni premaz na unutrašnjoj i vanjskoj strani; SJ 244; □ N 28; S – VII; N – 193; T – Z, imitacija Drag. 37; Fa – VKJ 13
- SJ 194/195**
- 101.** Poklopac, dno je neznatno izvijeno prema van, stijenke su malo konveksno zakrivljene i sužavaju se prema drški (T. 14: 3).  
dR – 17 cm; WT – 0,5 cm; St – malo hrapava CS – CF – crvena (2,5YR6/6–5/6) do smeđa (7,5YR4/1); SJ 194; □ N 30; S – VII; N – 220; T – P1; Fa – VKJ 2
- 102.** Zdjelica s blago izvijenim obodom, S profilacije. Posuda je s vanjske i unutrašnje strane prevučena crnim premazom. Tijelo je blago zaobljeno i manje u promjeru od oboda (T. 14: 4).  
dR – 17 cm; dV – 16,7 cm; WT – 0,4 cm; St – glatka; CS – vani: crna (2,5Y3/1) do smeđa (10YR4/2), unutra: crna (5Y2,5/1); CF – crna (2,5Y3/1); D – crni premaz s vanjske i unutrašnje strane; SJ 194; □ N 30; S – VII; N – 220; T – Z4; Fa – VKJ 2
- SJ 196/197**
- 103.** Ulomci dna i donjeg dijela većeg lonca ili dolija. Dno je ravno, a bočne stijenke ukošene (T. 14: 5).  
dB – 23 cm; WT – 0,8 cm; CS – narančasta (7,5YR6/4); CF – smeđa (7,5YR6/6); SJ 196; □ N 31; S – VII; PN – 16; T – L?; Fa – VKJ 2
- 98** Fragment of a gray fired vessel; a pot or a jug. Slanting side wall is preserved (Pl. 12: 6).  
WT – 0.5–0.7 cm; CS – gray (GLE Y1 4/N–2.5Y7/1); CF – gray (2.5Y6/1); D – narrow and shallow horizontal grooves; SU 499; □ K/L 29/30; A – VII; F – 261; T – ?; Fa – VKJ 4
- 99** Fragment of a gray fired vessel; a pot or a jug. A fragment of a side wall is preserved (Pl. 12: 7).  
WT – 0.5 cm; CS – gray (2.5Y5/1); CF – gray (2.5Y5/2); D – irregular and shallow parallel grooves; SU 499; □ K/L 29/30; A – VII; F – 261; T – ?; Fa – VKJ 4
- Complex 5**  
**SU 244/245**
- 100** A rim of a bowl. Slightly rounded side walls; rim protruding outward. It is a Pannonian imitation of a Drag. 37 bowl. Remains of red slip on the inside and on the outside (Pl. 14: 1).  
WT – 0.6 cm; CS – orange to red (5YR7/3–2.5YR5/8); CF – brown (2.5YR5/4); D – red slip on both surfaces; SU 244; □ N 28; A – VII; F – 193; T – Z, imitation of Drag. 37; Fa – VKJ 13
- SU 194/195**
- 101** A lid; rim slightly protruding outward, walls somewhat convexly curved, narrowing toward the handle (Pl. 14: 3).  
dR – 17 cm; WT – 0.5 cm; S – slightly coarse; CS – CF – red (2.5YR6/6–5/6) to brown (7.5YR4/1); SU 194; □ N 30; A – VII; F – 220; T – P1; Fa – VKJ 2
- 102** An S-profiled bowl with a slightly protruding rim. Covered with black slip on the outside and on the inside. Slightly rounded body with the diameter smaller than the rim (Pl. 14: 4).  
dR – 17 cm; dV – 16.7 cm; WT – 0.4 cm; S – smooth; CS – outer surface: black (2.5Y3/1) to brown (10YR4/2), inner surface: black (5Y2.5/1); CF – black (2.5Y3/1); D – black slip on both surfaces; SU 194; □ N 30; A – VII; F – 220; T – Z4; Fa – VKJ 2
- SU 196/197**
- 103** Fragments of the base and the lower part of a larger pot or a dolia. Flat base; slanting side walls (Pl. 14: 5).  
dB – 23 cm; WT – 0.8 cm; CS – orange (7.5YR6/4); CF – brown (7.5YR6/6); SU 196; □ N 31; A – VII; SF – 16; T – L?; Fa – VKJ 2
- 104** Fragments of the base and the lower part of a larger pot or a dolia. Flat base; slanting side walls (Pl. 14: 6).  
dR – 17 cm; WT – 0.6 cm; CS – orange (7.5YR6/4); CF – brown (7.5YR6/6); SU 196; □ N 31; A – VII; SF – 16; T – L?; Fa – VKJ 2



**104.** Ulomci dna i donjeg dijela većeg lonca ili dolija. Dno je ravno, a bočne stijenke ukošene (T. 14: 6).  
dR – 17 cm; WT – 0,6 cm; CS – narančasta (7,5YR6/4); CF – smeđa (7,5YR6/6); SJ 196; □ N 31; S – VII; PN – 16; T – L?; Fa – VKJ 2

### Kompleks 6

#### SJ 168/169

**105.** Dva ulomka vrata posude. Riječ je o vrču ili loncu, vrat je profiliran (T. 14: 8).  
WT – 0,4 cm; CS – tamno siva (GLE1 4/N); CF – smeđa (2,5YR5/6); D – profilirani vrat; SJ 168; □ U 32; S – VII; N – 251; T – ?; Fa – ?

#### SJ 190/191

**106.** Ulomak koso izvijenog oboda, bez tragova očuvanog premaza, grube izrade (T. 14: 9).  
WT – 0,8 cm; CS – narančasta do siva (5YR7/6–4/1); CF – crna (GLE1 2,5/N); SJ 190; □ P 30; S – VII; N – 216; T – L?; Fa – VKJ 2

**107.** Ulomak poklopca kosih bočnih stijenki, bez premaza, grube izrade (T. 14: 10).  
dR – 20 cm; WT – 0,8 cm; CS – crvena do siva (5YR6/8–4/1); CF – smeđa (5YR5/6); SJ 190; □ P 30; S – VII; N – 216; T – P1; Fa – VKJ 2

**108.** Dno posude vrlo grube izrade (T. 14: 11).  
dB – 18 cm; WT – 0,7 cm; CS – smeđa (7,5YR6/4); CF – smeđa (7,5YR4/2); SJ 190; □ P 30; S – VII; N – 216; T – dno; Fa – ?

### Kompleks 7

#### SJ 340/341

**109.** Ulomak ramena lonca grube i nepravilne izrade (T. 15: 1).  
WT – 0,6 cm; CS – crvena (5YR6/4); CF – siva (5YR4/2); SJ 340; □ O 26; S – VI; N – 248; T – ?; Fa – VKJ 2

**110.** Ulomak ramena posude grube i nepravilne izrade (T. 15: 2).  
WT – 0,4 cm; CS – smeđa do crna (5YR6/3–GLE1 2,5/N); CF – crna (GLE1 2,5/N); SJ 340; □ O 26; S – VI; N – 248; T – ?; Fa – VKJ 2

### Kompleks 8

#### SJ 320/321

**111.** Dva ulomka dna veće posude. Dno je ravno, a bočne stijenke blago zaobljene. Posuda je grube izrade bez tragova premaza. Na dnu se s unutrašnje strane uočavaju tragovi prstiju i alatki lončara (T. 15: 3).  
dB – 11 cm; WT – 0,7 cm; CS – crvena do smeđa (2,5YR6/8–4/1); CF – siva do smeđa (2,5YR3/1–5/4); SJ 320; □ J/K 27; S – VII; PN – 20; T – ?; Fa – VKJ 2

### Complex 6

#### SU 168/169

**105** Two fragments of the neck of a vessel. It is a jug or a pot with a profiled neck (Pl. 14: 8).  
WT – 0.4 cm; CS – dark gray (GLE1 4/N); CF – brown (2.5YR5/6); D – profiled neck; SU 168; □ U 32, A – VII; F – 251; T – ?; Fa – ?

#### SU 190/191

**106** Fragment of an obliquely protruding rim, without preserved traces of slip and of coarse craftsmanship (Pl. 14: 9).  
WT – 0.8 cm; CS – orange to gray (5YR7/6–4/1); CF – black (GLE1 2.5/N); SU 190; □ P 30; A – VII; F – 216; T – L?; Fa – VKJ 2

**107** Fragment of a lid with slanting side walls, without slip and of coarse craftsmanship (Pl. 14: 10).  
dR – 20 cm; WT – 0.8 cm; CS – red to gray (5YR6/8–4/1); CF – brown (5YR5/6); SU 190; □ P 30; A – VII; F – 216; T – P1; Fa – VKJ 2

**108** The base of a coarsely crafted vessel (Pl. 14: 11).  
dB – 18 cm; WT – 0.7 cm; CS – brown (7.5YR6/4); CF – brown (7.5YR4/2); SU 190; □ P 30; A – VII; F – 216; T – base; Fa – ?

### Complex 7

#### SU 340/341

**109** Fragment of the shoulder of a coarse, irregularly shaped, pot (Pl. 15: 1).  
WT – 0.6 cm; CS – red (5YR6/4); CF – gray (5YR4/2); SU – 340; □ O 26; A – VI; F – 248; T – ?; Fa – VKJ 2

**110** Fragment of the shoulder of a coarse, irregularly shaped, pot (Pl. 15: 2).  
WT – 0.4 cm; CS – brown to black (5YR6/3–GLE1 2.5/N); CF – black (GLE1 2.5/N); SU – 340; □ O 26; A – VI; F – 248; T – ?; Fa – VKJ 2

### Complex 8

#### SU 320/321

**111** Two fragments of the base of a larger pot. Flat base; slightly rounded side walls. Coarse vessel without any traces of slip. Fingerprints of the potter and traces of tools visible on the inner side of the base (Pl. 15: 3).  
dB – 11 cm; WT – 0.7 cm; CS – red to brown (2.5YR6/8–4/1); CF – gray to brown (2.5YR3/1–5/4); SU – 320; □ J/K 27; A – VII; SF – 20; T – ?; Fa – VKJ 2

#### SU 360/361

**112** An S-profiled bowl. Outward protruding rim; short neck; slightly rounded body. Uneven firing colour; slip preserved on the inside. The width of the body is smaller than the width of the rim (Pl. 15: 4).

**SJ 360/361**

**112.** Zdjela S profilacije. Obod je izvijen prema van, vrat kratak, tijelo blago zaobljeno. Boja pečenja je neujednačena, na unutrašnjoj stijenki sačuvan je premaz. Širina trbuha zdjele ne prelazi širinu oboda (T. 15: 4).

$dR - 24,4$  cm;  $dV - 24,5$  cm;  $dN - 23,8$  cm;  $hV - > 9$  cm;  $WT - 0,55$  cm;  $St -$  malo hrapava;  $CS -$  vani: crvena (5YR6/6) do smeđa (7,5YR4/2), unutra: crna (2,5Y3/1);  $CF -$  crna (2,5Y3/1);  $SJ 360$ ;  $\square L 26$ ;  $S - VII$ ;  $PN - 21$ ;  $T - Z4$ ;  $Fa - VKJ 2$

**Kompleks 9****SJ 642/643**

**113.** Lonac s dvije drške i ravnim dnom. Na vanjskoj stijenki slabo je sačuvan premaz (T. 15: 6).

$dB - 8$  cm;  $dV -$  oko 13 cm  $WT - 0,9$  cm;  $St -$  glatka  $CS -$  vani: crna (GLE1 3/N), unutra: smeđe siva (10YR4/2);  $CF -$  smeđe siva (10YR4/2);  $dH - 2$  cm;  $SJ 642$ ;  $\square E/F 3/4$ ;  $S - XIV$ ;  $N - 417$ ;  $T - L5$ ;  $Fa - VKJ 2$

**114.** Ulomak posude s drškom. Vjerojatno se radi o loncu s dvije drške. Očuvan je dio trbuha s profiliranom drškom, bez tragova premaza (T. 15: 7).

$dH - 2,8 \times 1,8$  cm;  $WT - 0,8$  cm;  $CS -$  siva (7,5YR5/2);  $CF -$  smeđesiva (7,5YR5/6-10YR4/1);  $SJ 642$ ;  $\square E/F 3/4$ ;  $S - XIV$ ;  $N - 417$ ;  $T - L5?$ ;  $Fa - VKJ 2$

**115.** Ulomak profilirane drške. Vjerojatno je pripadala loncu s dvije drške (T. 15: 8).

$dH - 3 \times 1,2$  cm;  $CS -$  smeđa (7,5YR7/2);  $CF -$  smeđa (7,5YR6/6);  $SJ 642$ ;  $\square E/F 3/4$ ;  $S - XIV$ ;  $N - 417$ ;  $T - L5?$ ;  $Fa - VKJ 2$

**116.** Poklopac s drškom koja se malo sužava na prijelazu u tijelo koje se neznatno širi prema obodu. Drška je s unutrašnje strane puna (T. 15: 9).

$WT - 0,5$  cm;  $St -$  hrapava, neravna;  $CS -$  vani: smeđa (7,5YR7/6), unutra: siva (2,5Y4/1);  $CF -$  smeđa (7,5YR7/6);  $dH - 5,3$  cm;  $SJ 642$ ;  $\square E/F 3/4$ ;  $N - 403$ ;  $T - P$ ;  $Fa - VKJ 2$

**117.** Ulomak plitke zdjele ili tanjura. Obod je zaobljen, bočne stijenke su blago zaobljene. Površina je gruba i nepravilna (T. 15: 10).

$WT - 0,8$  cm;  $CS - CF -$  crna (GLE1 2,5/N);  $SJ 642$ ;  $\square E/F 3/4$ ;  $S - XIV$ ;  $N - 417$ ;  $T - Z2?$ ;  $Fa - VKJ 2$

**118.** Ulomak glaziranog tarionika. Očuvan je dio bočne stijenke i prijelaz prema dnu. Unutrašnjost je prekrivena kamenčićima i maslinastozelenom glazurom. Kvalitetne izrade (T. 15: 11).

$WT - 1,8$  cm;  $CS -$  vani: narančasta (5YR7/8), unutra: zelenomaslinasta (2,5Y6/4);  $CF -$  siva (GLE2 6/5PB);  $D -$  glaze on the inner surface;  $SJ 642$ ;  $\square E/F 3/4$ ;  $S - XIV$ ;  $N$

$dR - 24,4$  cm;  $dV - 24,5$  cm;  $dN - 23,8$  cm;  $hV -$  larger than 9 cm;  $WT - 0,55$  cm;  $S -$  slightly coarse;  $CS -$  outer surface: red (5YR6/6) to brown (7,5YR4/2), inner surface: black (2,5Y3/1);  $CF -$  black (2,5Y3/1);  $SJ 360$ ;  $\square L 26$ ;  $A - VII$ ;  $SF - 21$ ;  $T - Z4$ ;  $Fa - VKJ 2$

**Complex 9****SJ 642/643**

**113** A pot with two handles and a flat base. Poorly preserved slip on the outer wall (Pl. 15: 6).

$dB - 8$  cm;  $dV -$  around 13 cm;  $WT - 0,9$  cm;  $S -$  smooth;  $CS -$  outer surface: black (GLE1 3/N), inner surface: brown to gray (10YR4/2);  $CF -$  brownish gray (10YR4/2);  $dH - 2$  cm;  $SJ 642$ ;  $\square E/F 3/4$ ;  $A - XIV$ ;  $F - 417$ ;  $T - L5$ ;  $Fa - VKJ 2$

**114** Fragment of a vessel with a handle. Probably a pot with two handles. A part of the body with a profiled handle, without traces of slip, is preserved (Pl. 15: 7).

$dH - 2,8 \times 1,8$  cm;  $WT - 0,8$  cm;  $CS -$  gray (7,5YR5/2);  $CF -$  brownish gray (7,5YR5/6-10YR4/1);  $SJ 642$ ;  $\square E/F 3/4$ ;  $A - XIV$ ;  $F - 417$ ;  $T - L5?$ ;  $Fa - VKJ 2$

**115** Fragment of a profiled handle. It probably belonged to a pot with two handles (Pl. 15: 8).

$dH - 3 \times 1,2$  cm;  $CS -$  brown (7,5YR7/2);  $CF -$  brown (7,5YR6/6);  $SJ 642$ ;  $\square E/F 3/4$ ;  $A - XIV$ ;  $F - 417$ ;  $T - L5?$ ;  $Fa - VKJ 2$

**116** A lid with a handle which narrows on the transition into the body which then widens towards the rim. The handle is full (Pl. 15: 9).

$dH - 5,3$  cm;  $WT - 0,5$  cm;  $S -$  coarse, uneven;  $CS -$  outer surface: brown (7,5YR7/6), inner surface: gray (2,5Y4/1);  $CF -$  brown (7,5YR7/6);  $SJ 642$ ;  $\square E/F 3/4$ ;  $F - 403$ ;  $T - P$ ;  $Fa - VKJ 2$

**117** Fragment of a shallow bowl or a plate. Rounded rim; slightly rounded side walls. Coarse and irregular surface (Pl. 15: 10).

$WT - 0,8$  cm;  $CS - CF -$  black (GLE1 2,5/N);  $SJ 642$ ;  $\square E/F 3/4$ ;  $A - XIV$ ;  $F - 417$ ;  $T - Z2?$ ;  $Fa - VKJ 2$

**118** Fragment of a glazed mortar. A part of the side wall, and its transition into the base is preserved. The inside is covered with pebbles and olive-green glaze. Quality craftsmanship (Pl. 15: 11).

$WT - 1,8$  cm;  $CS -$  outer surface: orange (5YR7/8), inner surface: olive-green (2,5Y6/4);  $CF -$  gray (GLE2 6/5PB);  $D -$  glaze on the inner surface;  $SJ 642$ ;  $\square E/F 3/4$ ;  $A - XIV$ ;  $F - 417$ ;  $T - Tr?$ ;  $Fa - VKJ 16$

**119** A mortar with an outward protruding rim; semi circularly thickened on the inside. The inside is roughened with pebbles and covered with green glaze (Pl. 15: 12).



– 417; T – Tr?; Fa – VKJ 16

**119.** Tarionik čiji je obod izvijen prema van, s unutrašnje strane je zadebljan polukružno. Unutrašnja strana je ogrubljena kamenčićima i premazana zelenom glazurinom (T. 15: 12).

dR – 32 cm; WT – 0,4 cm; St – glatka; CS – vani: narančasta (7,5YR8/6), unutra: narančasta (7,5YR8/6) s tragovima zelene glazure (2,5Y6/4); CF – narančasta (7,5YR8/6); SJ 642; □ E/F 3/4; S – XIV; N – 417; T – Tr1; Fa – VKJ 16

**120.** Dva ulomka dna dobro pečene posude, izrađene na kolu. No u sredini je blago izdignuto (T. 15: 13). dB – 8 cm; WT – 0,8 cm; CS – vani: siva (GLE1 5/N), unutra: smeđa (7,5YR6/2); CF – smeđa (7,5YR5/6); SJ 642; □ E/F 3/4; S – XIV; N – 417; T – ?; Fa – ?

**121.** Ulomak profilirane drške. Pretpostavlja se da je pripadala većem vrču ili stolnoj amfori ravnog dna. Nisu očuvani tragovi premaza (T. 15: 14).

dH – 3,7 x 1,4 cm; CS – narančasta (5YR7/6); CF – narančasta (5YR6/6); SJ 642; □ E/F 3/4; S – XIV; N – 417; T – amfora ravnog dna/vrč; Fa – ?

#### SJ 674/675

**122.** Lonac čiji je obod blago izvijen prema van i malo zadebljan, u presjeku je pravokutan. Vrat je kratak i širi se u tijelo šire od oboda lonca (T. 16: 1).

dR – 20,6 cm; dN – 20,4 cm; WT – 0,5 cm; St – hrapava; CS – CF – smeđa (10R5/1); SJ 674; □ C 4; S – XIV; N – 389; T – L1; Fa – VKJ 2

**123.** Lonac s malo izvijenim obodom koji je zadebljan, vrat je kratak i naglašen urezom te se širi u tijelo šire od oboda lonca. Na obodu i vanjskoj stijenci nalazi se crni premaz (T. 16: 2).

dR – 14 cm; dN – 13,8 cm; WT – 0,5 cm; St – zaglađena; CS – CF – smeđa (10YR4/1); D – premaz na obodu i vanjskoj stijenci; SJ 674; □ C 4; S – XIV; N – 390; T – L2; Fa – VKJ 2

**124.** Poklopac ravnog oboda i bočnih stijenci koje su zaobljene prema van (T. 16: 3).

dR – 21 cm; WT – 0,8 cm; St – neravna; CS – vani: tamno crvena (5YR4/2), unutra: crna do smeđa (7,5YR2,5/1–5/4); CF – crna (7,5YR2,5/0); SJ 674; □ C 4; S – XIV; N – 403; T – P3; Fa – VKJ 2

**125.** Zdjelica čiji je obod izvijen i zaobljen prema unutra. Bočne stjenke su konkavno zakrivljene te prekrivene crnim premazom (T. 16: 4).

dR – 15 cm; WT – 0,6–0,8 cm; St – zaglađena; CS – crna (GLE1 2,5/N); CF – smeđa (10R5/4); SJ 674; □ C 4; S – XIV; N – 390; T – Z2; Fa – VKJ 2

dR – 32 cm; WT – 0,4 cm; S – smooth; CS – outer surface: orange (7.5YR8/6), inner surface: orange (7.5YR8/6) with traces of olive green glaze (2.5Y6/4); CF – orange (7.5YR8/6); SU 642; □ E/F 3/4; S – XIV; F – 417; T – Tr1; Fa – VKJ 16

**120** (T 15: 13) Two fragments of the base of a well fired vessel made on a wheel. The base slightly raised in the middle.

dB – 8 cm; WT – 0.8 cm; CS – outer surface: gray (GLE1 5/N), inner surface: brown (7.5YR6/2); CF – brown (7.5YR5/6); SU 642; □ E/F 3/4; A – XIV; F – 417; T – ?; Fa – ?

**121** Fragment of a profiled handle. It is assumed that it belonged to a larger jug or a flat-based table amphora. Traces of slip are not preserved (Pl. 15: 14).

dH – 3.7 x 1.4 cm; CS – orange (5YR7/6); CF – orange (5YR6/6); SU 642; □ E/F 3/4; A – XIV; F – 417; T – flat-based amphora/flagon; Fa – ?

#### SU 674/675

**122** A pot with a slightly outward protruding, thickened rim, rectangular in the cross-section. Short neck, widening into the body which is wider than the rim (Pl. 16: 1).

dR – 20.6 cm; dN – 20.4 cm; WT – 0.5 cm; S – coarse; CS – CF – brown (10R5/1); SU 674; □ C 4; A – XIV; F – 389; T – L1; Fa – VKJ 2

**123** A pot with a slightly protruding, thickened rim; short neck emphasized by the incision, widening into the body which is wider than the rim. Black slip on the rim and on the outer wall of the vessel (Pl. 16: 2).

dR – 14 cm; dN – 13.8 cm; WT – 0.5 cm; S – smoothed; CS – CF – brown (10YR4/1); D – slip on both surfaces; SU 674; □ C 4; A – XIV; F – 390; T – L2; Fa – VKJ 2

**124** A lid with a straight rim and side walls curved outward (Pl. 16: 3).

dR – 21 cm; WT – 0.8 cm; S – uneven; CS – outer surface: dark red (5YR4/2), inner surface: black to brown (7.5YR2.5/1–5/4); CF – black (7.5YR2.5/0); SU 674; □ C 4; A – XIV; F – 403; T – P3; Fa – VKJ 2

**125** A small bowl with a rounded, inward protruding rim. Side walls are concavely curved and covered with black slip (Pl. 16: 4).

dR – 15 cm; WT – 0.6–0.8 cm; S – smoothed; CS – black (GLE1 2.5/N); CF – brown (10R5/4); SU 674; □ C 4; A – XIV; F – 390; T – Z2; Fa – VKJ 2

#### SU 732/733

**126** Fragment of a slide wall of a cup with pleats (*Faltenbecher*). Made of orange fired clay with red slip on the outside and on the inside. The cup probably had six

**SJ 732/733**

**126.** Ulomak bočne stijenke čaše s naborima (*Faltenbecher*). Izrađena je od narančasto pečene gline sa crvenim premazom vanjskoj i unutrašnjoj strani. Čaša je vjerojatno imala 6 nabora (T. 16: 5).

WT – 0,4 cm; CF – narančasto (2,5YR6/8), premaz crveni (10R5/8); CF – narančasta (2,5YR5/8); D – gusti crveni mat premaz; SJ 732; □ C 1/2; S – XIV; N – 399; T – Čaša s naborima; Fa – pročišćena struktura s vrlo malo primjesa, vidljivih tek pod uvećanjem

**SJ 802/803**

**127.** Lonac širokog oboda koji je koso izvijen prema van i blago zaobljen, vrat je kratak i odmah se koso širi u tijelo. Ima sačuvane tragove premaza i gara (T. 16: 6).

dR – 17 cm; dN – 16,1 cm; WT – 0,9 cm; St – hrapava; CS – vani: siva (2,5Y4/1–10YR4/1), unutra: siva (10YR4/1); CF – siva (10YR4/1); SJ 802; □ C/D 1; S – XIV; N – 455; T – L4; Fa – VKJ 2

**128.** Lonac manjih dimenzija širokog oboda koji je koso izvijen prema van i zaobljen je. Vrat je kratak i koso se širi u tijelo (T. 16: 7).

dR – 11 cm; dN – 10,7 cm; WT – 0,5 cm; St – hrapava; CS – vani: smeđa (7,5YR6/6), unutra: tamnosmeđa (5YR3/1); CF – tamnosmeđa (5YR3/1); SJ 802; □ C/D 1; S – XIV; N – 455; T – L4; Fa – VKJ 2

**129.** Ulomak zdjele uvučenog oboda, zaobljenog ruba, grube izrade (T. 16: 8).

WT – 0,8 cm; CS – tamnosiva (7,5YR4/1); CF – crna (GLEY1 2,5/N); SJ 802; □ C/D 1/(M/L33); S – XIV; N – 449; T – Z2; Fa – VKJ 2

**130.** Cilindrični keramički predmet čiji je obod blago izvijen prema van i zaobljen je. Pri dnu je zaobljeno izvijen prema van i na tom dijelu stoji, kao da je nakon loma pobrušen. Na cilindričnom dijelu posude nalaze se dvije perforacije (T. 16: 9).

dR – 15 cm; dB – 17 cm; dV – 14,2 cm; hV – 8,5 cm; WT – 0,9 cm; St – neravna, rukom rađena, nije hrapava; CS – vani: narančasta (5YR6/6) do siva (10YR4/1), unutra: svijetlo (GLEY1 7/10Y) do tamno siva (GLEY1 4/N); CF – narančasta (5YR6/6), svijetlo siva (GLEY1 7/10Y) do crna (GLEY1 2,5/N); SJ 802; □ C/D 1; N – 440; Tip – *Varia*; Fa – VKJ 2

**131.** Posuda za čuvanje hrane širokog oboda koji je neznatno koso izvijen prema van te profiliran. S vanjske strane ima neuredno izvedenu vodoravnu liniju. Vrat je cilindričan i neravan. Od središnjeg dijela vrata počinje drška. Vrat se naglo širi u visoko rame. Na vanjskoj i unutrašnjoj stijenci posuda ima premaz (T. 16: 10).

dR – 14 cm; dN – 13,6 cm; WT – 0,8 cm; St – gruba, ne-

pleats (Pl. 16: 5).

WT – 0,4 cm; CF – orange (2.5YR6/8), red slip (10R5/8); CF – orange (2.5YR5/8); D – thick red matte slip; SU 732; □ C 1/2; A – XIV; F – 399, T – Indented beaker; Fa – purified with a small amount of inclusions, visible only under magnifier

**SU 802/803**

**127** A pot with a wide, obliquely outward protruding, slightly rounded rim; short neck which immediately widens slanting into the body. Preserved traces of slip and soot (Pl. 16: 6).

dR – 17 cm; dN – 16.1 cm; WT – 0.9 cm; S – coarse; CS – outer surface: gray (2.5Y4/1–10YR4/1), inner surface: gray (10YR4/1); CF – gray (10YR4/1); SU 802; □ C/D 1; A – XIV; F – 455; T – L4; Fa – VKJ 2

**128** A smaller pot with a wide, obliquely outward protruding, rounded rim. Short neck which widens slanting into the body (Pl. 16: 7).

dR – 11 cm; dN – 10.7 cm; WT – 0.5 cm; S – coarse; CS – outer surface: brown (7.5YR6/6), inner surface: dark brown (5YR3/1); CF – dark brown (5YR3/1); SU 802; □ C/D 1; A – XIV; F – 455; T – L4; Fa – VKJ 2

**129** Fragment of a coarsely crafted bowl with an indented rim with a rounded edge (Pl. 16: 8).

WT – 0.8 cm; CS – dark gray (7.5YR4/1); CF – black (GLEY1 2.5/N); SU – 802; □ C/D 1/(M/L 33); A – XIV; A – 449; T – Z2; Fa – VKJ 2

**130** Cylindrical ceramic item with a slightly outward protruding, rounded rim. It is roundly curved outward at the base, and it is standing on that section as if it was punctured after the brake. There are two perforations on the cylindrical part of the vessel (Pl. 16: 9).

dR – 15 cm; dB – 17 cm; dV – 14.2 cm; hV – 8.5 cm; WT – 0.9 cm; S – uneven, handmade, but not coarse; CS – outer surface: orange (5YR6/6) to gray (10YR4/1), inner surface: light (GLEY1 7/10Y) to dark gray (GLEY1 4/N); CF – orange (5YR6/6), light gray (GLEY1 7/10Y) to black (GLEY1 2.5/N); SU 802; □ C/D 1; F – 440; T – *Varia*; Fa – VKJ 2

**131** A vessel with a wide, slightly obliquely outward protruding, profiled rim, used for storing food. Uneven horizontal line incised on the outer surface. Cylindrical, rough neck. Handle starts at the middle of the neck. The neck abruptly widens into the high shoulder. Slip on the outside and on the inside of the vessel (Pl. 16: 10).

dR – 14 cm; dN – 13.6 cm; WT – 0.8 cm; S – coarse, uneven; CS – outer surface: dark gray (5YR3/1) – brown (7.5YR5/3), inner surface: brown (7.5YR5/3); CF – brown (7.5YR5/3); SU 802; □ C/D 1; F – 450; T – *Varia*; Fa – VKJ 15



ravna; CS – vani: tamno siva (5YR3/1) – smeđa (7,5YR5/3), unutra: smeđa (7,5YR5/3); CF – smeđa (7,5YR5/3); SJ 802; □ C/D 1; N – 450; T – *Varia*; Fa – VKJ 15

**132.** Tri ulomka drške grube izrade. Moguće je da je riječ o drški amfore lokalne proizvodnje kao što su kat br. 130–131. Ona se okomito nastavljala na vrat i spajala na rame posude što je drugačije od ručki lonaca L5 VKJ 2 strukture i panonskih sivo pečenih vrčeva. Ručka je u presjeku profilirana s tri duboka paralelna i okomita žlijeba koja su grubo izvedena (T. 16: 11).

dH – 3,6 x 1,7 cm; CS – smeđa do siva (5YR6/6–5/1); CF – smeđa (5YR5/4); D – tri okomita paralelna žlijeba na vanjskoj strani; SJ 802; □ C/D 1; S – XIV; N – 483; T – ?; Fa – VKJ 2

**133.** Ulomak dna posude grube i nepravilne izrade. Dno je ravno, bočne stijenke blago zaobljene. Na unutrašnjoj strani dna vidljivo je kako je posuda ručno izrađena (T. 17: 1).

dB – 5,7–6,2 cm; WT – 0,3–0,7 cm; CS – smeđesiva (5YR4/1); CF – smeđa (5YR5/6); SJ 802; □ C/D 1, (M/N 33); S – XIV; N – 483; T – ?; Fa – VKJ 2

**134.** Ulomak dna posude grube izrade. Posuda je rađena rukom i otisci prstiju lončara su jasno vidljivi s unutrašnje strane dna. Nema tragova očuvanog premaza (T. 17: 2).

dB – 14 cm; WT – 0,6 cm; CS – svijetlosmeđa (10YR7/4); CF – smeđa (7,5YR5/3); SJ 802; □ C/D 1, (M/N 33); S – XIV; N – 483; T – ?; Fa – VKJ 2

**135.** Ulomak stijenke zeleno glaziranog tarionika. Posuda je rađena na kolu, s unutrašnje strane se nalaze utisnuti sitni kamenčići i loše očuvani tragovi zelenomaslinaste glazure (T. 17: 3).

WT – 1,5 cm; CS – vani: crvena (2,5YR6/6), unutra: siva (GLE1 8/N); CF – crna (GLE1 3/N); St – utisnuti kamenčići na unutrašnjoj stijenki; D – zelenomaslinasta glazura na unutrašnjosti; SJ 802; □ C/D 1, (M/N 33); S – XIV; N – 483; T – Tr?; Fa – VKJ 2?

**136.** Ulomak oboda i bočne stijenke zdjele, imitacije Drag. 37. Obod je zadebljan, s vanjske strane zaobljen. Na unutrašnjoj i vanjskoj stijenki su očuvani tragovi crvenog mat premaza (T. 17: 4).

WT – 0,3–1 cm; CS – crvena (2,5YR6/6–5/6); CF – crvena (2,5YR5/6); D – crveni premaz; SJ 802; □ C/D 1, (M/N 33); S – XIV; N – 449; T – imitacija Dr. 37; Fa – VKJ 10

**137.** Ulomak pompejanskog tanjura panonske izrade. Obod je zadebljan, unutrašnji rub uglat. Bočne stijenke su blago zaobljene, na unutrašnjoj stijenki su djelomično očuvani tragovi smeđeg premaza (T. 17: 5).

WT – 0,8 cm; CS – svijetlosmeđa do smeđa (7,5YR7/2–

**132** Three fragments of a coarse crafted handle. It could be a handle of a locally produced amphora as are Cat. Nos. 130–131. It vertically exceeds into the neck and connects to the shoulder of the vessel which distinguishes it from L5 pots of VKJ 2 fabric and the Pannonian gray fired jugs. The handle is profiled in cross-section with three parallel and vertical roughly crafted grooves (Pl. 16: 11).

dH – 3.6 x 1.7 cm; CS – brown to gray (5YR6/6–5/1); CF – brown (5YR5/4); D – three vertical and parallel grooves on the outer surface; SU 802; □ C/D 1; A – XIV; F – 483; T – ?; Fa – VKJ 2

**133** Fragment of the base of a coarse, poorly crafted vessel. Flat base; slightly rounded side walls. Traces of hand moulding visible on the inside (Pl. 17: 1).

dB – 5.7–6.2 cm; WT – 0.3–0.7 cm; CS – brownish gray (5YR4/1); CF – brown (5YR5/6); SU 802; □ C/D 1, (M/N 33); A – XIV; F – 483; T – ?; Fa – VKJ 2

**134** Fragment of the base of a coarsely crafted vessel. The vessel is handmade, and the fingerprints of the potter are visible on the inside of the base. There are no preserved traces of slip (Pl. 17: 2).

dB – 14 cm; WT – 0.6 cm; CS – light brown (10YR7/4); CF – brown (7.5YR5/3); SU 802; □ C/D 1, (M/N 33), A – XIV; F – 483; T – ?; Fa – VKJ 2

**135** Fragment of the wall of a green-glazed mortar. The vessel is made on the wheel; pebbles are impressed on the inside; poorly preserved traces of an olive-green glaze (Pl. 17: 3).

WT – 1.5 cm; CS – outer surface: red (2.5YR6/6), inner surface: gray (GLE1 8/N); CF – black (GLE1 3/N); S – impressed pebbles on the inner surface; D – olive-green glaze on the inner surface; SU 802; □ C/D 1, (M/N 33); A – XIV; F – 483; T – Tr?; Fa – VKJ 2?

**136** Fragment of the rim and the side wall of a bowl, imitation of Drag. 37. Thickened rim, rounded on the outside. Traces of red matte slip preserved on the inner and on the outer wall (Pl. 17: 4).

WT – 0.3–1 cm; CS – red (2.5YR6/6–5/6); CF – red (2.5YR5/6); D – red slip; SU 802; □ C/D 1, (M/N 33); A – XIV; F – 449; T – imitation of Dr. 37; Fa – VKJ 10

**137** Fragment of a Pompeian plate of the Pannonian production. Thickened rim with an angular inner edge. Slightly rounded side walls; partially preserved traces of brown slip on the inside (Pl. 17: 5).

WT – 0.8 cm; CS – light brown to brown (7.5YR7/2–5/6); CF – light brown (7.5YR6/1); D – brown slip; SU 802; □ C/D 1, (M/N 33); A – XIV; F – 449; T – T2; Fa – VKJ 13

**138** Fragment of the base of a plate, without traces of



- 5/6); CF – svijetlosmeđa (7,5YR6/1); D – smeđi premaz; SJ 802; □ C/D 1, (M/N 33); S – XIV; N – 449; T – T2; Fa – VKJ 13
- 138.** Ulomak dna tanjura bez tragova slikanja. Dno je ravno, bočne stijenke ukošene (T. 17: 6).  
WT – 0,6 cm; CS – svijetlocrvena do crvena (5YR7/6); CF – crvena (5YR6/8); SJ 802; □ C/D 1, (M/N 33); S – XIV; N – 449; T – T?; Fa – VKJ 13
- 139.** Ulomak dna posude kvalitetne izrade. Posuda je bila izrađena na kolu. Dno je ravno, uz rub se nalaze dvije plitko urezane koncentrične kružnice. Bočne stijenke blago su zaobljene. S vanjske strane nalazi se plitko urezana vodoravna linija (T. 17: 7).  
dB – 6,2 cm; WT – 0,8–0,9 cm; CS – svijetlocrvena (7,5YR7/4); CF – svijetlocrvena (7,5YR7/2); SJ 802; □ C/D 1, (M/N 33); S – XIV; N – 449; T – ?; Fa – VKJ 13
- 140.** Ulomak zdjele. Posuda je izrađena u tehnici tere sigilate, u Rheinzabern radionici. Obod je neznatno uvučen prema unutra, bočne stijenke su zaobljene. Dobro je očuvan tamnocrveni premaz (T. 17: 8).  
dR – 19,8 cm; dV – 20,3 cm; WT – 0,5 cm; CS – narančasta do crvena (10R7/8–2,5YR6/8); CF – narančasta (2,5YR6/8); D – sjajni, crveni premaz; SJ 802; □ C/D 1; S – XIV; N – 440; T – Drag. 32, Rheinzabern radionica; Fa – pročišćena glina, prisutne su pukotine i primjese pijeska
- 141.** Dva ulomka lonca sivo pečene panonske keramike grube izrade. Obod je okomito izvučen, trokutasto oblikovan, vrat cilindričan, rame ukošeno (T. 17: 9).  
WT – 0,7 cm; CS – siva (5YR6/2–GLEY14/N); CF – smeđa (2,5Y4/1); SJ 802; □ C/D 1, (M/N 33); S – XIV; N – 483; T – L?; Fa – VKJ 11
- 142.** Ulomak manjeg lonca širokog oboda koji je koso izvijen prema van i zaobljen je. Vrat je kratak i koso se širi u tijelo. Ima sačuvan mjestimice sivi premaz (T. 17: 10).  
dR – 10 cm; dN – 8,8 cm; WT – 0,3 cm; St – malo hrapava; CS – siva (GLEY1 5/N); CF – svijetlo crvena (10R6/3); SJ 802; □ C/D 1, (M/N 33); S – XIV; N – 440; T – L4; Fa – VKJ 8
- 143.** Ulomak oboda i vrata lonca ili vrča panonske sivo pečene keramike. Obod je polukružno izvijen prema van sa zaobljenim rubom. Rame je ukošeno (T. 17: 11).  
WT – 0,4 cm; CS – siva (GLEY1 7/N); CF – siva (GLEY1 6/N); SJ 802; □ C/D 1, (M/N 33); S – XIV; N – 449; T – ?; Fa – VKJ 7
- 144.** Ulomak oboda lonca ili vrča panonske sivo pečene keramike. Obod je polukružno izvijen i zadebljan, rame je ukošeno (T. 17: 12).  
paint. Flat base; slanting side walls (Pl. 17: 6).  
WT – 0,6 cm; CS – light red to red (5YR7/6); CF – red (5YR6/8); SU 802; □ C/D 1, (M/N 33); A – XIV; F – 449; T – T?; Fa – VKJ 13
- 139** Fragment of the base of a quality crafted vessel made on the wheel. Flat base; two shallow, concentric circles along the edge. Slightly rounded side walls. Shallow, incised, horizontal line on the outside (Pl. 17: 7).  
dB – 6.2 cm; WT – 0.8–0.9 cm; CS – light red (7.5YR7/4); CF – light red (7.5YR7/2); SU 802; □ C/D 1, (M/N 33); A – XIV; F – 449; T – ?; Fa – VKJ 13
- 140** Fragment of a bowl. Produced in the *terra sigillata* technique, in Rheinzabern workshop. the rim is slightly protruding inward; rounded side walls. Well preserved dark red slip (Pl. 17: 8).  
dR – 19.8 cm; dV – 20.3 cm; WT – 0.5 cm; CS – orange to red (10R7/8–2.5YR6/8); CF – orange (2.5YR6/8); D – red glossy slip; SU 802; □ C/D 1; A – XIV; F – 440; T – Drag. 32, Rheinzabern workshop; Fa – purified clay, visible voids and sand inclusions
- 141** Two fragments of a gray fired, coarsely crafted, Pannonian pot. Vertically protruding, triangularly shaped rim; cylindrical neck; slanted shoulder (Pl. 17: 9).  
WT – 0.7 cm; CS – gray (5YR6/2–GLEY14/N); CF – brown (2.5Y4/1); SU 802; □ C/D 1, (M/N 33); A – XIV; F – 483; T – L?; Fa – VKJ 11
- 142** Fragment of a smaller pot with a wide, outward protruding, thickened rim. Short neck which widens slanting into the body. Gray slip preserved in places (Pl. 17: 10).  
dR – 10 cm; dN – 8.8 cm; WT – 0.3 cm; S – slightly coarse; CS – gray (GLEY1 5/N); CF – light red (10R6/3); SU 802; □ C/D 1, (M/N 33); A – XIV; F – 440; T – L4; Fa – VKJ 8
- 143** Fragment of the rim and the neck of a pot or a jug of the gray fired Pannonian ware. The rim is semicircular, protruding outward, with a rounded edge. Slanted shoulder (Pl. 17: 11).  
WT – 0.4 cm; CS – gray (GLEY1 7/N); CF – gray (GLEY1 6/N); SU 802; □ C/D 1, (M/N 33); A – XIV; F – 449; T – ?; Fa – VKJ 7
- 144** Fragment of the rim of a pot or a jug of the gray fired Pannonian ware. The rim is semicircular, protruding outward, with a rounded edge. Slanted shoulder (Pl. 17: 12).  
WT – 0.4 cm; CS – gray (GLEY1 6/N); CF – gray (GLEY1 5/N); SU 802; □ C/D 1, (M/N 33); A – XIV; F – 449; T – ?; Fa – VKJ 7
- 145** Two fragments of a gray fired jug. A handle and a part





WT – 0,4 cm; CS – siva (GLE Y1 6/N); CF – siva (GLE Y1 5/N); SJ 802; □ C/D 1, (M/N 33); S – XIV; N – 449; T – ?; Fa – VKJ 7

**145.** Dva ulomka sivo pečenog vrča. Očuvana je ručka, dio oboda i vrata. Ručka je blago profilirana, izdiže se iznad oboda i spajala se s trbuhom vrča. Obod je malo zadebljan, izvijen prema van, vrat ukošen (T. 17: 13).

dH – 3 x 1,2 cm; WT – 0,3 cm; CS – siva (GLE Y1 5/N); CF – siva (GLE Y1 7/N); SJ 802; □ C/D 1, (M/N 33); S – XIV; N – 483; T – vrč; Fa – VKJ 8

**146.** Ulomak ručke i oboda vrča od sivo pečene keramike. Blago profilirana drška se nastavlja visoko iznad oboda. Na površini su očuvani tragovi tamno sivog tankog premaza (T. 17: 14).

dH – 3,5 x 1,3 cm; WT – 0,6 cm; CS – siva (GLE Y1 5/N–3/N); CF – smeđesiva (5YR5/1); St – vrlo tanko premaz; SJ 802; □ C/D 1, (M/N 33); S – XIV; N – 483; T – vrč; Fa – VKJ 8

**147.** Dva ulomka ručke i trbuha vrča sivo pečene keramike. Ručka je blago profilirana, a trbuh zaobljen (T. 17: 15).

dH – 3,6 x 1,3 cm; WT – 0,7 cm; CS – siva (GLE Y1 6/N); CF – siva (GLE Y1 5/N) SJ 802; □ C/D 1, (M/N 33); S – XIV; N – 483; T – vrč; Fa – VKJ 7

**148.** Ulomak dna sivo pečene posude na nozi. Noga je ukošena, dno ravno, bočne stijenke su ukošene (T. 17: 16).

dF – 9,7 cm; WT – 0,4 cm; CS – siva do roza (GLE Y1 5/N–10YR 8/3); CF – siva (GLE Y1 5/N); SJ 802; □ C/D 1, (M/N 33); S – XIV; N – 449; T – ?; Fa – ?

**149.** Ulomak dna sivo pečene posude. Noga je jedva naglašena, s vanjske strane je ukošena. Bočne stijenke su blago zaobljene. S vanjske strane loše je očuvan u tragovima tanki premaz (T. 17: 17).

dF – 10,2 cm; WT – 0,6 cm; CS – siva (5Y7/1); CF – siva (5Y6/1); SJ 802; □ C/D 1, (M/N 33); S – XIV; N – 449; T – ?; Fa – VKJ 4

#### SJ 844/855

**150.** Ulomak poklopca izrađenog od nepročišćene gline, izrađen rukom. Drška poklopca je u presjeku trokuta, a površina drške je ravna (T. 18: 1).

dH – 6 cm; WT – 0,5 cm; CS – vani: smeđa (10YR4/1), unutra: smeđa (10YR4/1) do tamno smeđa (10YR3/1); CF – smeđa (10YR4/1); SJ 844; □ (L 32/33); N – 552; T – P?; Fa – VKJ 2

**151.** Dva ulomka velikog vrča ili amfore. Drška je profilirana s dva plitka žlijeba i postavljena je okomito na tijelo

of the rim and the neck are preserved. The handle is slightly profiled, it rises above the rim and connects to the body of a jug. The rim is slightly thickened and protruding outward; the neck is slanted (Pl. 17: 13).

dH – 3 x 1.2 cm; WT – 0.3 cm; CS – gray (GLE Y1 5/N); CF – gray (GLE Y1 7/N); SU 802; □ C/D 1, (M/N 33); A – XIV; F – 483; T – flagon; Fa – VKJ 8

**146** Fragment of the handle and the rim of a gray fired jug. Slightly profiled handle rises high above the rim. Traces of dark gray thin slip preserved on the surface (Pl. 17: 14).

dH – 3.5 x 1.3 cm; WT – 0.6 cm; CS – gray (GLE Y1 5/N–3/N); CF – brownish gray (5YR5/1); S – very thin slip; SU 802; □ C/D 1, (M/N 33), A – XIV; F – 483; T – flagon; Fa – VKJ 8

**147** Two fragments of the handle and the body of a gray fired jug. Slightly profiled handle; rounded body (Pl. 17: 15).

dH – 3.6 x 1.3 cm; WT – 0.7 cm; CS – gray (GLE Y1 6/N); CF – gray (GLE Y1 5/N; SU 802; □ C/D 1, (M/N 33), A – XIV; F – 483; T – flagon; Fa – VKJ 7

**148** Fragment of the base of a gray fired vessel on a foot. Oblique foot; flat base; slanted side walls (Pl. 17: 16).

dF – 9.7 cm; WT – 0.4 cm; CS – gray to pink (GLE Y1 5/N–10YR 8/3); CF – gray (GLE Y1 5/N); SU 802; □ C/D 1, (M/N 33); A – XIV; F – 449; T – ?; Fa – ?

**149** Fragment of the base of a gray fired vessel. Hardly emphasized foot, slanted on the outside. Slightly rounded side walls. Poorly preserved traces of thin slip on the outer surface (Pl. 17: 17).

dF – 10.2 cm; WT – 0.6 cm; CS – gray (5Y7/1); CF – gray (5Y6/1); SU 802; □ C/D 1, (M/N 33); A – XIV; F – 449; T – ?; Fa – VKJ 4

#### SU 844/855

**150** Fragment of a lid made by hand of unrefined clay. The handle of a lid is triangular in cross-section and its surface is smooth (Pl. 18: 1).

dH – 6 cm; WT – 0.5 cm; CS – outer surface: brown (10YR4/1), inner surface: brown (10YR4/1) to dark brown (10YR3/1); CF – brown (10YR4/1); SU 844; □ (L 32/33), F – 552; T – P?; Fa – VKJ 2

**151** Two fragments of a larger jug or an amphora. The handle is profiled with two shallow grooves and placed perpendicular to the body of the vessel (Pl. 18: 2).

dH – 4 x 1.2 cm; CS – light orange (7.5YR 7/4); CF – orange to gray (7.5YR6/4–6/1); SU 844; □ (L 32/33); F – 552; T – ?; Fa – VKJ 13

**152** A mortar with the rim thickened on the inside with a



posude (T. 18: 2).

dH – 4 x 1,2 cm; CS – svijetlo narančasta (7,5YR 7/4); CF – narančasta do siva (7,5YR6/4–6/1); SJ 844; □ (L 32/33); N – 552; T – ?; Fa – VKJ 13

- 152.** Tarionik čiji je obod s unutrašnje strane zadebljan polukružnim rebrom koje prelazi u izljev. Sami obod je polukružno izvijen prema van, a unutrašnjost je ogrubljena kamenčićima (T. 18: 3a–3b).

dR – 29 cm; WT – 0,8 cm; St – hrapava; CS – vani: narančasta (7,5YR7/6), unutra: crvena (2,5YR6/6); CF – narančasta (7,5YR7/6) do siva (10YR7/1); SJ 844; □ L 32/33; N – 552; T – Tr2; Fa – VKJ 16

- 153.** Ulomak posude s tragovima mat crvenog premaza na unutrašnjoj strani. Vjerojatno je riječ o ulomku pompejskog tanjura panonske proizvodnje (T. 18: 4).

WT – 0,6 cm; CS – narančasta (5YR7/4), crvena (2,5YR5/8); CF – narančasta (2,5YR5/6); D – crveni premaz; SJ 844; □ (L 32/33); N – 552; T – ?; Fa – VKJ 13

#### SJ 874/875

- 154.** Lonac većih dimenzija, širokog oboda koji je izvijen prema van, vrat je kratak i širi se u visoko zaobljeno rame. Tijelo posude je šire od oboda. Na vanjskoj stijenci ima premaz (T. 18: 5).

dR – 21 cm; dN – 20 cm; WT – 0,55 cm; St – zaglađena; CS – vani: crna (GLE1 3/N), unutra: smeđa (10YR4/1); CF – smeđa (10YR4/1); SJ 874; □ (M 33); N – 528; T – L2; Fa – VKJ 2

#### SJ 966/967

- 155.** Ulomak lonca zaobljenog i izvijenog oboda i zaobljenog ramena (T. 18: 7).

WT – 0,4–0,6 cm; CS – smeđa do tamnosmeđa (5YR5/3–3/1); CF – tamnosmeđa (5YR2,5/1); SJ 966; □ (J/K 32/33); N – 543; T – L2; Fa – VKJ 2

- 156.** Ulomak ramena lonca ili vrča. Vrat je ukošen, rame blago zaobljeno. Na vanjskoj stijenci očuvani su tragovi gustog, mat crvenog premaza (T. 18: 8).

WT – 0,4 cm; CS – vani: svijetlo crvena (5YR7/6), premaz crveni (10R5/8), unutra: tamno crvena (10R5/2), CF – u sredini siva (2,5Y7/2), uz rubove crvena (2,5YR5/6); D – slikanje crvenom mat bojom na vanjskoj strani; SJ 966; □ (J/K 32/33), N – 543; T – ?; Fa – dobro pročišćena struktura s primjesama uočljivim pod uvećanjem te pukotinama

- 157.** Tri ulomka čaše. Obod je neznatno izvijen prema van, a ispod njega se s vanjske strane nalazi vodoravno urezana linija. U središnjem dijelu tijela čaše, nalaze se tri reda ovalnih, blago ukošenih ovalnih udubljenja, a iznad i ispod nalaze se po dva reda vodoravno urezanih

semi-circular rib which exceeds into the spout. The rim itself is semi-circularly protruding outward and the inside is roughened by pebbles (Pl. 18: 3a–3b).

dR – 29 cm; WT – 0.8 cm; S – coarse; CS – outer surface: orange (7.5YR7/6), inner surface: red (2.5YR6/6); CF – orange (7.5YR7/6) to gray (10YR7/1); SU 844; □ L 32/33; F – 552; T – Tr2; Fa – VKJ 16

- 153** Fragment of a vessel with traces of matte red slip on the inside. It is probably a fragment of a Pompeian plate of the Pannonian production (Pl. 18: 4).

WT – 0.6 cm; CS – orange (5YR7/4), red (2.5YR5/8); CF – orange (2.5YR5/6); D – red slip; SU 844; □ (L 32/33); F – 552; T – ?; Fa – VKJ 13

#### SU 874/875

- 154** A larger pot with a wide, outward protruding rim; short neck widening into a high rounded shoulder. The body of the vessel is wider than its rim. Slip on the outer surface (Pl. 18: 5).

dR – 21 cm; dN – 20 cm; WT – 0.55 cm; S – smoothed; CS – outer surface: black (GLE1 3/N), inner surface: brown (10YR4/1); CF – brown (10YR4/1); SU 874; □ (M 33); F – 528; T – L2; Fa – VKJ 2

#### SU 966/967

- 155** Fragment of a pot with a rounded, protruding rim and a rounded shoulder (Pl. 18: 7).

WT – 0.4–0.6 cm; CS – brown to dark brown (5YR 5/3–3/1); CF – dark brown (5YR2.5/1); SU 966; □ (J/K 32/33); F – 543; T – L2; Fa – VKJ 2

- 156** Fragment of the shoulder of a pot or a jug. Slanted neck; slightly rounded shoulder. Traces of thick, matte red slip preserved on the outer surface (Pl. 18: 8).

WT – 0.4 cm; CS – outer surface: light red (5YR7/6), red slip (10R5/8), inner surface: dark red (10R5/2), CF – gray in the middle (2,5Y7/2), red toward the surface (2.5YR5/6); D – outer surface: painted with red matte colour; SU 966; □ (J/K 32/33); F – 543; T – ?; Fa – very well purified fabric with inclusions and voids visible under magnifier

- 157** Three fragments of a beaker. The rim slightly protruding outward; below it, on the outside, incised horizontal line. On the middle segment of the beaker there are three rows of oval, slightly slanted impressions, and below and above them, there are two rows of incised horizontal lines. On the lower segment of the body, below the first horizontal line (below the impressions) the cup is painted ochre, somewhat darker than the firing colour. The vessel is quality crafted in mould of well purified clay (Pl. 18: 9).

dR – 8 cm; dV – 5.9 cm; hV – 10.2 cm on the preserved part; WT – 0.1 cm; S – smooth; CS – ochre 7.5YR8/4), in



linija. U donjem dijelu trbuha, ispod prve vodoravne linije (ispod udubljenja) čaša je bila bojana oker bojom, nešto tamnijom od boje pečenja. Posuda je izrađena od dobro pročišćene gline, dobre je kvalitete pečenja, rađena je u kalupu (T. 18: 9).

*dR* – 8 cm; *dV* – 5,9 cm; *hV* – 10,2 cm u sačuvanom dijelu; *WT* – 0,1 cm; *St* – glatka; *CS* – oker (7,5YR8/4), u donjem dijelu ima oker premaz nešto tamniji od boje pečenja (7,5YR6/4); *CF* – oker (7,5YR8/4); *D* – donji dio čaše je bojan oker bojom, posuda je ukrašena vodoravnim urezima i ovalnim udubljenjima; *SJ* 966; □ (J 33); *PN* – 54; *T* – čaša; *Fa* – jako pročišćena struktura bez vidljivih primjesa

### SJ 1006/1007

**158.** Lonac širokog oboda koji je koso izvijen prema van i malo je zadebljan. S vanjske strane prijelaz prema vratu je naglašen. Vrat je kratak i širi se u blago zaobljeno rame. Unutrašnja strana oboda (koja je bila dobro vidljiva jer je vrat koso izvučen prema van) te vanjska stjenka posude imali su premaz koji je većim dijelom nesačuvan (T. 18: 10).

*dR* – 21 cm; *dN* – 19,4 cm; *WT* – 0,6–0,85 cm; *St* – hrapava; *CS* – vani: smeđa (7,5YR6/6–10YR4/1), unutra: smeđa do siva (10YR3/1–7,5YR5/3); *CF* – smeđa do siva (10YR3/1–7,5YR5/3); *D* – obod s unutrašnje strane i vanjska strana posude imali su premaz; *SJ* 1006; □ (J 31) *N* – 534; *T* – L2; *Fa* – VKJ 2

### SJ 1229/1230

**159.** Ulomak zdjele panonske sive keramike. Na vanjskoj stjenki očuvan je crni sjajni premaz u ukras izveden kotačićem, na unutrašnjoj stijenki premaz je lošije očuvan, vidljiv je samo pod uvećanjem (T. 18: 11).

*WT* – 0,4–0,6 cm; *CS* – siva crni (5Y6/1), premaz crni (GLE1 3/N); *CF* – siva (5Y5/1); *D* – gusti crni premaz i ukras kotačićem, *SJ* 1229; □ (J 28); *N* – 468; *T* – zdjela; *Fa* – VKJ 8

### SJ 1341/1342

**160.** Lonac čiji je obod malo izvijen prema van, vrat je jedva naglašen i koso se širi prema trbuhu. Posuda je rađen rukom od nepročišćene gline s malo primjesa. Na posudi nema tragova premaza (T. 18: 15).

*dR* – 24 cm; *dN* – 23,3 cm; *WT* – 1,1 cm; *St* – neravna, malo hrapava; *CS* – (2,5Y4/1; GLE1 3/N); *CF* – tamno siva (2,5Y3/1) do crvena (2,5YR6/6); *SJ* 1341; □ (K 26/27); *S* – XVI; *N* – 675; *T* – L1; *Fa* – VKJ 2

**161.** Zdjela S profilacije s obodom koji je malo izvijen prema van. Vrat je vrlo kratak i širi se u naglašeni donji dio posude. Posuda nije rađena na kolu, glina nije pročišćena i ima malo primjesa. Površina je neravna, malo hrapava i ima tragova crnog premaza na unutrašnjoj stijenki.

the lower part it has an ochre slip, slightly darker than the firing colour (7.5YR6/4); *CF* – ochre (7.5YR8/4); *D* – lower part of the beaker is coloured with ochre colour, the vessel is decorated with horizontal incisions and oval impressions; *SU* 966; □ (J 33); *SF* – 54; *T* – beaker; *Fa* – very refined fabric without visible inclusions

### SU 1006/1007

**158** A pot with a wide, obliquely outward protruding, slightly thickened rim. Transition to the neck is emphasized on the outside. Short neck which widens into the slightly rounded shoulder. The inner side of the rim (which was quite visible since the neck is protruding outward), and the outside of the vessel, were covered by the poorly preserved slip (Pl. 18: 10).

*dR* – 21 cm; *dN* – 19.4 cm; *WT* – 0.6–0.85 cm; *S* – coarse; *CS* – outer surface: brown (7.5YR6/6–10YR4/1), inner surface: brown to gray (10YR3/1–7.5YR5/3); *CF* – brown to gray (10YR3/1–7.5YR5/3); *D* – slip on the inner side of the rim and outer side of the vessel; *SU* 1006, □ (J 31) *F* – 534; *T* – L2; *Fa* – VKJ 2

### SU 1229/1230

**159** Fragment of a bowl of gray Pannonian ceramics. Black glossy slip and rouletting decoration preserved on the outside, while on the inside the slip is poorly preserved and visible only under magnifier (Pl. 18: 11).

*WT*: 0.4–0.6 cm; *CS*: gray to black (5Y6/1), black slip (GLE1 3/N); *CF*: gray (5Y5/1); *D* – thick black slip and rouletting decoration; *SU* 1229; □ (J 28), *F* – 468; *T* – bowl; *Fa* – VKJ 8

### SU 1341/1342

**160** A pot with the rim slightly protruding outward and a hardly emphasized neck which widens toward the body. The vessel is handmade of unrefined clay with scarce inclusions. There are no traces of slip (Pl. 18: 15).

*dR* – 24 cm; *dN* – 23.3 cm; *WT* – 1.1 cm; *S* – uneven, slightly coarse; *CS* – (2.5Y4/1; GLE1 3/N); *CF* – dark gray (2.5Y3/1) to red (2.5YR6/6); *SU* 1341; □ (K 26/27); *A* – XVI; *F* – 675; *T* – L1; *Fa* – VKJ 2

**161** An S-profiled bowl with a slightly outward protruding rim. Very short neck which widens into the emphasized lower segment of the vessel. The vessel was not made on the wheel, the clay is unrefined and the inclusions are scarce. The surface is uneven, slightly rough and with traces of black slip on the inside wall (Pl. 18: 16).

*WT* – 0.7 cm; *S* – uneven; *CS* – dark gray (GLE1 4/N); *CF* – dark gray (GLE1 4/N); *D* – inner surface: black slip; *SU* 1341; □ (K 26/27); *A* – XVI; *F* – 675; *T* – Z4; *Fa* – VKJ 2

### SU 1363/1364

**162** A pot with a slightly protruding rim which has a somewhat emphasized slot for the lid on its inner wall.



Služila za kuhanje ili serviranje tekućeg sadržaja (T. 18: 16).

WT – 0,7 cm; St – neravna; CS – tamno siva (GLEY1 4/N); CF – tamno siva (GLEY1 4/N); D – crni premaz na unutrašnjoj stijenci; SJ 1341; □ (K 26–27); S – XVI; N – 675; T – Z4; Fa –VKJ 2

### SJ 1363/1364

**162.** Lonac sa blago izvijenim obodom koji na unutrašnjoj stijenci ima blago naglašeni utor za poklopac. Glina je nepročišćena s malo primjesa. Vrat je kratak, na ulomku nema tragova premaza (T. 19: 1).

dR – 21 cm; dN – 20 cm; WT – 0,75 cm; St – hrapava; CS – vani: crvena (5YR6/8), unutra: tamno siva – crna (10YR4/1–3/1); CF – tamnosiva – crna (10YR4/1–3/1); SJ 1363; □ (I/J 24/25); S – XVII; N – 455; T – L2; Fa – VKJ 2

**163.** Ulomak ručke. Vjerojatno je pripadala tipu lonca s dvije ručke. Neznatno je profilirana, polukružno savijena. Djelomično su očuvani tragovi crnog premaza (T. 19: 2).

dH – 1,9 x 1,1 cm; St – premaz; CS – smeđa (7,5YR4/3); CF – smeđa (7,5YR4/1); SJ 1363; □ (I/J 24/25); S – XVII; N – 455; T – L5?; Fa – VKJ 2

**164.** Ulomci donjeg dijela lonca. Očuvano je dno i ukošene bočne stijenske. Posuda je rađena na brzo rotirajućem kolu, grube je izrade (T. 19: 3).

dB – 7,9 cm; WT – 0,6 cm; CS – CF – GLEY1 2,5/N; SJ 1363; □ (I/J 24/25); S – XVII; N – 455; T – L?; Fa – VKJ 22

**165.** Ulomak zdjelice vodoravno izvijenog oboda koji je ukrašen s dvije koncentrične kružnice. Unutrašnjost je prekrivena loše sačuvanom zelenom glazurom (T. 19: 4a–4b).

dR – 12,8 cm; WT – 0,6 cm; St – hrapava; CS – vani: crvena (5YR7/6); unutra: zelena (5Y7/4); CF – crvena (5YR7/6); D – obod je ukrašen dvjema koncentričnim kružnicama; SJ 1363; □ (I/J 24/25); S – XVII; N – 455; T – Z3; Fa – VKJ 16

**166.** Ulomak dna zelenoglazirane zdjele. Dno je zadebljano i ravno, bočne stijenske su zaobljene. Glazura se nalazi na unutrašnjoj strani (T. 19: 5).

dB – 6 cm; WT – 0,5 cm; CS – vani: narančasta (5YR7/6), zelenomaslinasta (2,5Y7/2); CF – narančasta (7,5YR7/4); D – zelenomaslinasta glazura; SJ 1363; □ (I/J 24/25); S – XVII; T – Z3 ?; Fa – 16

**167.** Ulomak zelenoglaziranog tarionika. Na unutrašnjoj stijenci nalaze se utisnuti kamenčići različite veličine preliveni debelim slojem zelenomaslinaste glazure (T. 19: 6).

WT – 0,6 cm; CS – vani: crvena (2,5YR7/6), unutra maslinasto zelena (5Y5/4); CF – narančasta do siva (5Y6/1–7/1,

Unrefined clay with scarce inclusions. Short neck. There are no traces of slip on the fragment (Pl. 19: 1).

dR – 21 cm; dN – 20 cm; WT – 075 cm; S – coarse; CS – outer surface: red (5YR6/8), inner surface: dark gray to black (10YR4/1–3/1); CF – dark gray to black (10YR4/1–3/1); SU 1363; □ (I/J 24/25); A – XVII; F – 455; T – L2; Fa – VKJ 2

**163** Fragment of a handle. It probably belonged to the type of the pot with two handles. Slightly profiled, semi-circularly curved. Partially preserved traces of black slip (Pl. 19: 2).

dH – 1.9 x 1.1 cm; CS – brown (7.5YR4/3); CF – brown (7.5YR4/1); S – slip; SU 1363; □ (I/J 24/25), A – XVII; F – 455; T – L5?; Fa – VKJ 2

**164** Fragments of the lower segment of a pot. The base and slanting side walls are preserved. The vessel is coarsely crafted on the fast-rotating wheel (Pl. 19: 3).

dB – 7.9 cm; WT – 0.6 cm; CS – CF – GLEY1 2.5/N; SU 1363; □ (I/J 24/25); A – XVII; F – 455; T – L?; Fa – VKJ 22

**165** Fragment of a small bowl with a horizontally protruding rim decorated with two concentric circles. The inside is covered with a poorly preserved green glaze (Pl. 19: 4a–4b).

dR – 12.8 cm; WT – 0.6 cm; S – coarse; CS – outer surface: red (5YR7/6); inner surface: green (5Y7/4); CF – red (5YR7/6); D – rim is decorated with two concentric circles; SU 1363; □ (I/J 24/25); A – XVII; F – 455; T – Z3; Fa – VKJ 16

**166** Fragment of the base of a green-glazed bowl. Flat, thickened rim; rounded side walls. The glaze is on the inside (Pl. 19: 5).

dB – 6 cm; WT – 0.5 cm; CS – outer surface: orange (5YR7/6), olive-green (2.5Y7/2); CF – orange (7.5YR7/4); D – olive-green glaze; SU 1363; □ (I/J 24/25); A – XVII; T – Z3 ?; Fa – 16

**167** Fragment of a green-glazed mortar. Pebbles of different sizes impressed on the inner wall, covered with a thick layer of olive-green glaze (Pl. 19: 6).

WT – 0.6 cm; CS – outer surface: red (2.5YR7/6), inner surface: olive-green (5Y5/4); CF – orange to gray (5Y6/1–7/1; 5YR6/6); D – olive-green glaze; SU 1363; □ (I/J 24/25); A – XVII; F – 455; T – Tr?; Fa – VKJ 13

**168** Fragment of the base of a red painted pottery. Probably a Pompeian plate. Matte red slip preserved only on the upper segment. Flat base (Pl. 19: 7).

WT – 0.7 cm; CS – orange to red (2.5YR7/3–5/8); CF – dark red (2.5YR7/6); D – inner surface: red slip; SU 1363; □ (I/J 24/25); A – XVII; F – 455; T – T?; Fa – VKJ 16



5YR6/6); D – zelenomaslinasta glazura; SJ 1363; □ (I/J 24/25); S – XVII; N – 455; T – Tr?; Fa – VKJ 13

**168.** Ulomak dna posude crveno slikane keramike. Vjerojatno je riječ o pompejanskom tanjuru. Crveni mat premaz je očuvan samo na gornjoj strani. Dno je ravno (T. 19: 7).

WT – 0,7 cm; CS – narančasta do crvena (2,5YR7/3–5/8); CF – tamno crvena (2,5YR7/6); D – crveni premaz na unutrašnjoj strani; SJ 1363; □ (I/J 24/25); S – XVII; N – 455; T – T?; Fa – VKJ 16

#### SJ 1405/1406

**169.** Lonac širokog oboda koji je izvijen prema van i zadebljan je. Zadebljanje je ukrašeno sa četiri koncentrične kružnice. Premaz crne boje nalazi se s vanjske i unutrašnje strane posude (T. 20: 1).

dR – 18,8 cm; dN – 19 cm; WT – 0,5–1,6 cm; St – glatka; CS – crna (GLE Y1 3/N); CF – crvena (10R7/6–6/6); D – obod je ukrašen sa četiri urezane koncentrične kružnice; SJ 1405; □ (I 25); S – XVII; N – 1009; T – L7; Fa – VKJ 27

#### SJ 1431/1432

**170.** Tanjur ravnog dna svijetlo smeđe boje pečenja. Obod je zadebljan i okrenut prema unutrašnjoj strani. Bočne stijenke su blago zakošene prema dnu koje je neznatno uže od oboda. Na unutrašnjoj stijenci nalaze se tragovi crvene boje (T. 20: 2).

dR – 22,4 cm; dB – 19,5 cm; hV – 3,65 cm; WT – 0,8 cm; St – bez posebne obrade, pomalo hrapava; CS – svijetlo smeđa (2,5YR 6/4); CF – svijetlo smeđa (2,5YR 6/4); SJ 1431; □ (I 25); S – XVII; N – 580; T – T2; Fa – VKJ 23

#### SJ 1495/1496

**171.** Manji lonac s obodom koso izvijenim prema van. Vrat je kratak, tijelo je nešto šire od oboda lonca. Rame lonca je zaobljeno. Površina je neravna, posuda je rađena rukom (T. 20: 3).

dR – 14 cm; dN – 13,3 cm; WT – 0,6 cm; St – hrapava, neravna; CS – vani: smeđa (2,5Y5/4), unutra: crna (GLE Y1 2,5/N); CF – smeđa prema vanjskoj strani (2,5Y5/4), crna prema unutrašnjoj (GLE Y1 2,5/N); SJ 1495; □ (K 24); S – XVII; N – 611; T – L3; Fa – VKJ 15

#### SJ 1507/1508

**172.** Ulomak posude, tanjura ili zdjele. Obod je neizražen, zaobljenog ruba. Bočne stijenke su ukošene. Posuda je grube i nepravilne izrade (T. 20: 5).

WT – 0,8 cm; CS – smeđa (10R6/3–5/3) CF – smeđa (10R4/1); SJ 1507; □ (J 23); S – XVII; N – 670; T – ?; Fa – VKJ 19

**173.** Ulomak zdjele izrađene u tehnici tere sigilate, Drag. 32, rajnzaberske proizvodnje. Obod je uvučen prema

#### SU 1405/1406

**169** A pot with a wide, outward protruding, thickened rim. The thickening is decorated with four concentric circles. Black slip on the inside and on the outside of the vessel (Pl. 20: 1).

dR – 18.8 cm; dN – 19 cm; WT – 0.5–1.6 cm; S – smooth; CS – black (GLE Y1 3/N); CF – red (10R7/6–6/6); D – rim is decorated with four incised concentric circles; SU 1405; □ (I 25); A – XVII; F – 1009; T – L7; Fa – VKJ 27

#### SU 1431/1432

**170** Light brown fired flat-based plate. The rim is thickened and protruding inward. Side walls are slightly slanted toward the base which is somewhat narrower than the rim. Traces of red paint on the inner wall (Pl. 20: 2).

dR – 22.4 cm; dB – 19.5 cm; hV – 3.65 cm; WT – 0.8 cm; S – without additional treatment, slightly coarse; CS – light brown (2.5YR6/4); CF – light brown (2.5YR6/4); SU 1431; A – XVII; □ (I 25); F – 580; T – T2; Fa – VKJ 23

#### SU 1495/1496

**171** A small pot with an obliquely outward protruding rim. Short neck; body somewhat wider than the rim of the pot. Rounded shoulder. Uneven surface; vessel handmade (Pl. 20: 3).

dR – 14 cm; dN – 13.3 cm; WT – 0.6 cm; S – coarse, uneven; CS – outer surface: brown (2.5Y5/4), inner surface: black (GLE Y1 2.5/N); CF – brown towards outer surface (2.5Y5/4), black towards inner surface (GLE Y1 2.5/N); SU 1495; □ (K 24); A – XVII; F – 611; T – L3; Fa – VKJ 15

#### SU 1507/1508

**172** Fragment of a vessel; a plate or a bowl. Inconspicuous rim with a rounded edge. Slanted side walls. Coarse and irregular craftsmanship (Pl. 20: 5).

WT – 0.8 cm; CS – brown (10R6/3–5/3) CF – brown (10R4/1); SU 1507; □ (J 23); A – XVII; F – 670; T – ?; Fa – VKJ 19

**173** Fragment of a bowl made in *terra siggilata* technique, Drag. 32, of Rheinzabern production. The rim protruding inward with a thinned edge. Partially preserved glossy red slip (Pl. 20: 6).

WT – 0.7 cm; CS – orange (10R7/6), red (10R5/6); CF – orange (10R6/6); D – red glossy slip; SU 1507; □ (J 23); A – XVII; F – 670; T – Drag. 32; Fa – purified clay with fragmented inclusions visible under magnifier

**174** Flat-based plate with semi-circularly thickened, inward protruding rim. Slightly inward curved side walls. Partially preserved bright red slip on the inside (Pl. 20: 7).

dR – 28 cm; dB – 25 cm; hV – 4.3 cm; WT – 0.6 cm; S – smooth; CS – outer surface: red (5YR5/4–7/6), inner surface: red firing colour (5YR7/6) with red slip (10R5/8); CF – red (5YR7/6); D – inner surface: bright red slip; SU



unutra sa stanjenim rubom. Sjajni premaz crvene boje je djelomice očuvan (T. 20: 6).

WT – 0,7 cm; CS – narančasta (10R7/6), crvena (10R5/6); CF – narančasta (10R6/6); D – crveni sjajni premaz; SJ 1507; □ (J 23); S – XVII; N – 670; T – Drag. 32; Fa – pročišćena glina s usitnjenim primjesama koje se uočavaju kod uvećanja

**174.** Tanjur ravnog dna s obodom koji je polukružno zadebljan i okrenut prema unutra. Bočne stjenke su prema unutrašnjosti vrlo blago zaobljene. Na unutrašnjoj strani djelomice je sačuvan žarko crveni premaz (T. 20: 7). dR – 28 cm; dB – 25 cm; hV – 4,3 cm; WT – 0,6 cm; St – glatka; CS – vani: crvena (5YR5/4–7/6), unutra crvena boja pečenja (5YR7/6) s crvenim premazom (10R5/8); CF – crvena (5YR7/6); D – s unutrašnje strane nalazi se žarko crveni premaz; SJ 1507; □ (J 23); S – XVII; N – 670; T – T2; Fa – VKJ 23

**175.** Ulomci lonca od svijetlosive pročišćene gline s vrlo malo primjesa. Posuda je rađena na kolu. Noga je prstenasto naglašena i iznad nje nalazi se plitko urezana vodoravna linija. Obod je izvučen prema van i malo je zadebljan, ispod njega nalazi se plitko urezana linija. Vrat je kratak i prelazi u rame koje nije sačuvano. Najveća širina posude je u gornjem dijelu trbuha. Posuda je bila ukrašena vodoravnim, plitko urezanim linijama od kojih su sačuvane tri. Noga nije u potpunosti sačuvana, a pretpostavlja se da je dno bilo ravno (T. 20: 8). dR – 15 cm; dB – 8 cm; dV – 16 cm ?; dN – 13,5 cm; hV – 14,4 cm; WT – 0,3 cm; St – glatka; CS – CF – svijetlo siva (2,5Y7/2); D – plitko urezane vodoravne linije; SJ 1507; □ (J 23); S – XVII; T – L3; Fa – VKJ 4

#### SJ 1576/1577

**176.** Lonac ravnog neizraženog oboda i kratkog cilindričnog vrata. Vrat se naglo širi u visoko rame (T. 20: 9). dR – 16 cm; dN – 15,9 cm; WT – 0,4 cm; St – hrapava; CS – CF – smeđa (7,5YR5/3); SJ 1576; □ (H/I 22); S – XVII; N – 704; T – L1; Fa – VKJ 26

#### SJ 1774/1775

**177.** Ulomak lonca blago izvijenog oboda, zaobljenog ruba. Posuda je vrlo grube izrade (T. 20: 11). WT – 0,6 cm; CS – vani: smeđa (10R5/3), unutra: svijetlo smeđa (7,5YR5/3); CF – smeđa (2,5YR5/4); SJ 1774; □ (F 16), S – XIX; N – 651; T – L1; Fa – VKJ 2

**178.** Ulomak lonca blago zaobljenog oboda, jedva naglašenog vrata. Obod je malo izvijen prema vani, ali je to izvedeno na neujednačen način budući da je posuda izrađena rukom. Obod je izveden na način da je kao traka prilijepljen na tijelo te je prstima spojen, ali ne do kraja što je dobro vidljivo s unutrašnje strane. Trbuh je najširi u

1507; □ (J 23); A – XVII; F – 670; T – T2; Fa – VKJ 23

**175** Fragments of a pot made of light-gray refined clay with scarce inclusions. The vessel is made on the wheel. The ring-foot is emphasized and there is a shallow horizontal line incised above it. The rim is protruding outward and thickened with a shallow incised line below it. The neck is short and it exceeds into the shoulder which is not preserved. The vessel is widest on the upper segment of the body. It was decorated with horizontal, shallowly incised lines of which three are preserved. The foot is only partially preserved but we can assume that it had a flat base (Pl. 20: 8).

dR – 15 cm; dB – 8 cm; dV – 16 cm ?; dN – 13.5 cm; hV – 14.4 cm; WT – 0.3 cm; S – smooth; CS – CF – light gray (2.5Y7/2); D – shallow horizontal incised lines; SU 1507; □ (J 23); A – XVII; T – L3; Fa – VKJ 4

#### SU 1576/1577

**176** A pot with a straight, unemphasised rim and a short cylindrical neck. The neck abruptly widens into the high shoulder (Pl. 20: 9).

dR – 16 cm; dN – 15.9 cm; WT – 0.4 cm; S – coarse; CS – CF – brown (7.5YR5/3); SU 1576; □ (H/I 22); A – XVII, F – 704; T – L1; Fa – VKJ 26

#### SU 1774/1775

**177** Fragment of a pot with a slightly protruding rim with a rounded edge. Very coarse craftsmanship (Pl. 20: 11). WT – 0.6 cm; CS – outer surface: brown (10R5/3), inner surface: light brown (7.5YR5/3); CF – brown (2.5YR5/4); □ (F 16), A – XIX; F – 651; T – L1; Fa – VKJ 2

**178** Fragment of a pot with a slightly protruding rim and hardly emphasized neck. The rim is only slightly and unevenly protruding outward since the vessel is handmade. The rim is actually a stripe of clay not fully attached to the body by hand, which is visible on its inner side. The body is widest on the lower segment of the vessel. Traces of slip are visible on the outside of the vessel (Pl. 20: 12).

dR – 9 cm; dV – 11.7 cm; dN – 8.5 cm; hV – on the preserved part 11.4 cm; WT – 0.5 cm; S – slightly coarse, uneven; CS – outer surface: black (10YR3/1), inner surface: brown (10YR6/4), black on the inner surface of the rim (10YR3/1); CF – brown towards the inner surface (10YR6/4), black on the outside (10YR6/4); □ (F 16), A – XIX; F – 680; T – L1; Fa – VKJ 2

**179** Fragment of the pot with an outward protruding, thickened rim. Short neck exceeds into a slightly emphasized shoulder. Smoothened outer wall; the pot is not made on the wheel therefore the walls are uneven and messy (Pl. 20: 13).

dR – 24 cm; dV – oko 26.5 cm; dN – 22 cm; WT – 0.7 cm;



donjem dijelu posude. S vanjske strane lonca nalaze se tragovi premaza (T. 20: 12).

$dR$  – 9 cm;  $dV$  – 11,7 cm;  $dN$  – 8,5 cm;  $hV$  – u sačuvanom dijelu 11,4 cm;  $WT$  – 0,5 cm;  $St$  – malo hrapava, neravna;  $CS$  – vani: crna (10YR3/1), unutra: smeđa (10YR6/4) na unutrašnjoj strani oboda crna (10YR3/1);  $CF$  – uz unutrašnji rub smeđa (10YR6/4), uz vanjski crna (10YR6/4);  $SJ$  1774; □ (F 16);  $S$  – XIX;  $N$  – 680;  $T$  – L1;  $Fa$  – VKJ 2

- 179.** Ulomak lonca s obodom koji je izvijen prema van i zaobljen je. Vrat posude je kratak i prelazi u rame koje nije jako naglašeno. Vanjska stjenka je zaglađena, a lonac nije rađen na kolu te su mu stjenke izvedene neravno i neuredno (T. 20: 13).

$dR$  – 24 cm;  $dV$  – oko 26,5 cm;  $dN$  – 22 cm;  $WT$  – 0,7 cm;  $St$  – zaglađena;  $CS$  – vani: tamno siva do svijetlo smeđa (5Y4/1–7,5YR6/4), unutra: tamno siva do crna (10YR3/1);  $CF$  – tamno siva do crna (10YR3/1);  $SJ$  1774; □ (F 16);  $S$  – XIX;  $N$  – 651;  $T$  – L2;  $Fa$  – VKJ 2

- 180.** Ulomak poklopca. Rub oboda je koso odrezan, bočna stijenka je blago utisnuta. Grube je izrade (T. 20: 14).

$WT$  – 0,8 cm;  $CS$  – vani: crvena (2,5YR6/4), unutra: bež do siva (2,5YR6/1–5YR4/1);  $CF$  – crvena do siva (10R5/6–GLE1 2,5/N);  $SJ$  1774; □ (F 16);  $S$  – XIX;  $N$  – 651;  $T$  – P1;  $Fa$  – VKJ 2

- 181.** Zdjela sa zaobljenim obodom koji je izvijen prema unutra. Bočne stjenke blago su zaobljene. Boja pečenja je ujednačena i crvena, a mjestimično je s unutrašnje strane sačuvan žarko crveni premaz (T. 20: 15).

$dR$  – 19 cm;  $hV$  – u sačuvanom dijelu 3,7 cm;  $WT$  – 0,65 cm;  $St$  – glatka;  $CS$  – crvena (5YR6/6);  $CF$  – crvena (5YR6/6);  $SJ$  1774; □ (F 16);  $S$  – XIX;  $N$  – 680;  $T$  – Z2;  $Fa$  – VKJ 23

#### SJ 1852/1853

- 182.** Ulomak lonca čiji je obod malo zadebljan i izvijen je prema van. Vrat posude je vrlo kratak i odmah prelazi u slabo naglašeno i zaobljeno rame. Na posudi nema tragova premaza i ukrasa (T. 21: 2).

$dR$  – 23,8 cm;  $dN$  – 23 cm;  $WT$  – 0,6 cm;  $St$  – malo hrapava, neravna;  $CS$  – vani: smeđa (7,5YR6/4), unutra: smeđe siva (7,5YR4/1);  $CF$  – prema unutrašnjem rubu tamno siva (7,5YR3/1), prema vanjskom rubu crvena (7,5YR5/4);  $SJ$  1852; □ (E/F/G 14/15);  $S$  – XIX/XX;  $N$  – 674;  $T$  – L2;  $Fa$  – VKJ 2

- 183.** Ulomak lonca koso izvijenog oboda, koso odrezanog ruba. Površina je hrapava i gruba (T. 21: 3).

$WT$  – 0,9 cm;  $CS$  – smeđa (5YR6/4);  $CF$  – smeđa (5YR5/6);  $SJ$  1852; □ (E/F/G 14/15);  $S$  – XIX/XX;  $N$  – 674;  $T$  – L8;  $Fa$  – VKJ 24

$S$  – smooth;  $CS$  – outer surface: dark gray to light brown (5Y4/1–7,5YR6/4), inner surface: dark gray to black (10YR3/1);  $CF$  – dark gray to black (10YR3/1);  $SU$  1774; □ (F 16);  $S$  XIX;  $F$  – 651;  $T$  – L2;  $F$  – VKJ 2

- 180** Fragment of a lid. The edge of the rim is obliquely cut and the side walls are slightly dented. Coarse craftsmanship (Pl. 20: 14).

$WT$  – 0.8 cm;  $CS$  – outer surface: red (2.5YR6/4), inner surface: beige to gray (2.5YR6/1–5YR4/1);  $CF$  – red to gray (10R5/6–GLE1 2.5/N);  $SU$  1774; □ (F 16);  $A$  – XIX;  $F$  – 651;  $T$  – P1;  $Fa$  – VKJ 2

- 181** A bowl with the rounded, inward protruding rim. Slightly rounded side walls. Even, red firing colour with bright red slip preserved in places on the inside (Pl. 20: 15).

$dR$  – 19 cm;  $hV$  – on the preserved part 3.7 cm;  $WT$  – 0.65 cm;  $S$  – smooth;  $CS$  – red (5YR6/6);  $CF$  – red (5YR6/6);  $SU$  1774; □ (F 16);  $A$  – XIX;  $F$  – 680;  $T$  – Z2;  $Fa$  – VKJ 23

#### SU 1852/1853

- 182** Fragment of a pot with a slightly thickened, outward protruding rim. Very short neck which immediately exceeds into the slightly emphasized, rounded shoulder. There are no traces of slip or decorations on the vessel (Pl. 21: 2).

$dR$  – 23.8 cm;  $dN$  – 23 cm;  $WT$  – 0.6 cm;  $S$  – slightly coarse, uneven;  $CS$  – outer surface: brown (7.5YR6/4), inner surface: brown gray (7.5YR4/1);  $CF$  – dark gray towards inner surface (7.5YR3/1), red towards outer surface (7.5YR5/4);  $SU$  1852; □ (E/F/G 14/15);  $A$  – XIX/XX;  $F$  – 674;  $T$  – L2;  $Fa$  – VKJ 2

- 183** fragment of a pot with an obliquely protruding rim with an obliquely cut edge. Coarse and rough surface (Pl. 21: 3).

$WT$  – 0.9 cm;  $CS$  – brown (5YR6/4);  $CF$  – brown (5YR5/6);  $SU$  1852; □ (E/F/G 14/15);  $A$  – XIX/XX;  $F$  – 674;  $T$  – L8;  $Fa$  – VKJ 24

- 184** Fragment of a vessel, probably a T 2 plate. Slanted side walls; thickened rim. Pillow-shaped edge on the inside. The vessel is quality crafted on the wheel (Pl. 21: 4).

$WT$  – 0.6 cm;  $CS$  – gray (5YR5/1);  $CF$  – gray (GLE1 3/N);  $SU$  1852; □ (E/F/G 14/15);  $A$  – XIX/XX;  $F$  – 674;  $T$  – T2?;  $Fa$  – VKJ 2

- 185** Fragment of a red fired mortar. The upper segment of the vessel is preserved, with the inner rounded rib placed lower than the rim (Pl. 21: 5).

$WT$  – 1.2 cm;  $CS$  – orange (5YR7/6);  $CF$  – brown (2.5YR5/6);  $SU$  1852; □ (E/F/G 14/15);  $A$  – XIX/XX;  $F$  – 674;  $T$  – Tr?;  $Fa$  – VKJ 23



- 184.** Ulomak posude, vjerojatno tanjura, T 2. Bočna stijjenka je ukošena, obod je zadebljan. Rub na unutrašnjoj strani jastučasto oblikovan. Posuda je dobre izrade, rađena na kolu (T. 21: 4).  
WT – 0,6 cm; CS – siva (5YR5/1); CF – siva (GLE1 3/N); SJ 1852; □ (E/F/G 14/15); S – XIX/XX; N – 674; T – T2?; Fa – VKJ 2
- 185.** Ulomak crveno pečenog tarionika. Očuvan je gornji dio posude s unutrašnjim zaobljenim rebrom, niže postavljanim od oboda (T. 21: 5).  
WT – 1,2 cm; CS – narančasta (5YR7/6); CF – smeđa (2,5YR5/6); SJ 1852; □ (E/F/G 14/15); S – XIX/XX; N – 674; T – Tr?; Fa – VKJ 23
- 186.** Ulomak drške poklopca od nepročišćene gline s vrlo malo sitnih primjesa. Radi se o poklopcu većih dimenzija za prekrivanje velike posude. Drška i stjenke su masivni, drška je na vrhu ravna, a sa strane zaobljena (T. 21: 6).  
dH – 9,3 cm; WT – 1,7 cm; St – malo hrapava; CS – siva (7,5YR4/1); CF – crvena (7,5YR6/6); SJ 1852; □ (E/F/G 14/15); S – XIX/XX; N – 674; T – P; Fa – VKJ 2
- 187.** Ulomak drške, u presjeku je trakasto oblikovana sa zaobljenim krajevima. Izrađena je od strukture koja je korištena za izradu L5 tipa lonaca (s dvije drške) (T. 21: 7).  
dH – 1,7 x 0,8 cm; CS – smeđa (2,5YR6/2); CF – smeđa (2,5YR5/4); SJ 1852; □ (E/F/G 14/15); S – XIX/XX; N – 674; T – L5 ?; Fa – VKJ 2
- 188.** Ulomak zaobljene drške koja je plosnata u presjeku. Na površini se nalazi vrlo tanak premaz (T. 21: 8).  
dH – 2,9 x 1,2 cm; CS – siva (GLE1 4/N); CF – smeđa (7,5YR5/4); St – tanki sivi premaz; SJ 1852; □ (E/F/G 14/15); S – XIX/XX; N – 674; T – L5 ?; Fa – VKJ 8
- 189.** Ulomak drške vrča crveno pečene boje. U presjeku, drška je profilirana širokim žlijebom (T. 21: 9).  
dH – 3,6 x 1,4 cm; CS – CF – narančasta (2,5YR6/8); SJ 1852; □ (E/F/G 14/15); S – XIX/XX; N – 674; T – ?; Fa – VKJ 9
- SJ 2133/2134**
- 190.** Ulomak tanjura koji je ukrašen crvenim slikanjem. Obod je uvučen prema unutra, rub je jastučasto zadebljan, bočne stijjenke su ukošene. Crveni premaz je bolje očuvan na unutrašnjoj strani (T. 21: 12).  
WT – 0,5 cm; CS – narančasta do crvena (5YR7/6–10R5/6); CF – narančasta (10R7/6); D – tamnocrveni premaz; SJ 2133; □ (G 14/15); S – XIX; N – 767; T – T2; Fa – VKJ 13
- 186** Fragment of the handle of a lid made of unrefined clay with scarce tiny inclusions. It is a large lid used for covering large vessels. The handle and the walls are massive, the handle has a flat top and rounded sides (Pl. 21: 6).  
dH – 9.3 cm; WT – 1.7 cm; S – slightly coarse; CS – gray (7.5YR4/1); CF – red (7.5YR6/6); SU 1852; □ (E/F/G 14/15); A – XIX/XX; F – 674; T – P; Fa – VKJ 2
- 187** Fragment of a ribbon-like handle with rounded ends. Made of fabric used for the production of L5 type pots (with two handles) (Pl. 21: 7).  
dH – 1.7 x 0.8 cm; CS – brown (2.5YR6/2); CF – brown (2.5YR5/4); SU 1852; □ (E/F/G 14/15); A – XIX/XX; F – 674; T – L5 ?; Fa – VKJ 2
- 188** Fragment of a rounded handle, flat in cross-section. Very thin slip on the surface (Pl. 21: 8).  
dH – 2.9 x 1.2 cm; CS – gray (GLE1 4/N); CF – brown (7.5YR5/4); S – thin gray slip; SU 1852; □ (E/F/G 14/15); A – XIX/XX; F – 674; T – L5 ?; Fa – VKJ 8
- 189** Fragment of a red fired jug handle. The handle is profiled by a wide groove in its cross-section (Pl. 21: 9).  
dH – 3.6 x 1.4 cm; CS – CF – orange (2.5YR6/8); SU 1852; □ (E/F/G 14/15); A – XIX/XX; F – 674; T – ?; Fa – VKJ 9
- SU 2133/2134**
- 190** Fragment of a red painted plate. Inward protruding rim with pillow-shaped edge; slanted side walls. Red slip better preserved on the inside (Pl. 21: 12).  
WT – 0.5 cm; CS – orange to red (5YR7/6–10R5/6); CF – orange (10R7/6); D – dark red slip; SU 2133; □ (G 14/15); A – XIX; F – 767; T – T2; Fa – VKJ 13
- SU 1788/1789**
- 191** Fragment of the rim and the neck of a coarse, poorly crafted jug (Pl. 21: 13).  
dR – 8.7 cm; dN – 7.9 cm; WT – 0.5 – 0.7 cm; CS – gray to brown (7.5YR5/2–5/3); CF – dark gray (GLE1 3/N); □ (G 15); A – XIX; F – 708; T – flagon; Fa – ?
- SU 1850/1851**
- 192** A pot with an outward protruding, slightly thickened rim. Short neck; body not much wider than the rim. Rounded shoulder (Pl. 21: 14).  
dR – 19 cm; dV – 20.3 cm; dN – 17.4 cm; WT – 0.3–0.5 cm; S – slightly coarse; CS – outer surface: orange (5YR6/8), inner surface: orange (5YR6/8) to brown (5YR5/4); CF – orange (5YR6/8); □ (E/F 14); A – XX; F – 738; T – L2; Fa – VKJ 2
- SU 2191/2192**
- 193** A larger pot with a wide, obliquely outward protruding rim with an almost rectangular edge. Very short neck which widens slanting into the body (Pl. 21: 16).



**SJ 1788/1789**

**191.** Ulomak oboda i vrata vrča grube i nepravilne izrade (T. 21: 13).

$dR$  – 8,7 cm;  $dN$  – 7,9 cm;  $WT$  – 0,5 – 0,7 cm;  $CS$  – siva do smeđa (7,5YR5/2–5/3);  $CF$  – tamnosiva (GLE Y1 3/N); □ (G 15);  $S$  – XIX;  $N$  – 708;  $T$  – vrč;  $Fa$  – ?

**SJ 1850/1851**

**192.** Lonac čiji je obod je izvijen prema van i malo je zadebljan. Vrat je kratak, a tijelo se ne širi znatno više od oboda. Rame je zaobljeno (T. 21: 14).

$dR$  – 19 cm;  $dV$  – 20,3 cm;  $dN$  – 17,4 cm;  $WT$  – 0,3–0,5 cm;  $St$  – malo hrapava;  $CS$  – vani: narančasta (5YR6/8), unutra: narančasta (5YR6/8) do smeđa (5YR5/4);  $CF$  – narančasta (5YR6/8); □ (E/F 14);  $S$  – XX;  $N$  – 738;  $T$  – L2;  $Fa$  – VKJ 2

**SJ 2191/2192**

**193.** Lonac većih dimenzija širokog oboda koji je koso izvijen prema van, a rub mu je gotovo pravokutan. Vrat je vrlo kratak i koso se širi u tijelo (T. 21: 16).

$dR$  – 24 cm;  $dN$  – 21,7 cm;  $WT$  – 0,4–0,9 cm;  $St$  – malo hrapava;  $CS$  – vani: crna (7,5YR2,5/1), unutra: smeđa (7,5YR6/3);  $CF$  – smeđa (7,5YR6/3); SJ 2191; □ (F 14);  $S$  – XIX;  $N$  – 623;  $T$  – L4;  $Fa$  – VKJ 2

**SJ 1978/1979**

**194.** Manji lonac čiji je obod lagano izvijen prema van, vrat je kratak. Tijelo je neznatno šire od samog tijela. Posuda je rađena rukom, površina je hrapava i neravna (T. 22: 1).

$dR$  – 11,1 cm;  $dV$  – 13 cm;  $dN$  – 10,7 cm;  $WT$  – 0,4 cm;  $St$  – gruba;  $CS$  – vani: smeđa (5YR4/1), unutra: smeđa (5YR4/2);  $CF$  – smeđa (5YR4/2); SJ 1978; □ (F/G 7/8);  $S$  – XXI;  $N$  – 667;  $T$  – L1;  $Fa$  – VKJ 2

**195.** Lonac širokog oboda koji je blago izvijen prema van, vrat je vrlo kratak i širi se u zaobljeno rame šire od oboda. Rađen je na kolu (T. 22: 2).

$dR$  – 15 cm;  $dN$  – 14,2 cm;  $WT$  – 0,55 cm;  $St$  – gruba, neravna;  $CS$  – vani: narančasta (10YR6/4), unutra: smeđa (10YR4/2);  $CF$  – smeđa (10YR4/2); SJ 1978; □ (F/G 7/8);  $S$  – XXI;  $N$  – 648;  $T$  – L1;  $Fa$  – VKJ 2

**196.** Lonac širokog oboda koji je izvijen prema van te malo zadebljan. Vrat je kratak i širi se u zaobljeno rame, šire od samog oboda. Posuda je izrađena rukom (T. 22: 3).

$dR$  – 18 cm;  $dV$  – 21,2 cm;  $dN$  – 17 cm;  $WT$  – 5,5 cm;  $St$  – hrapava, neravna;  $CS$  – vani: narančasta (7,5YR6/6), unutra: siva (7,5YR4/1);  $CF$  – narančasta (7,5YR6/6) do siva (7,5YR4/1); SJ 1978; □ (F/G 7/8);  $S$  – XXI;  $N$  – 648;  $T$  – L2;  $Fa$  – VKJ 2

$dR$  – 24 cm;  $dN$  – 21.7 cm;  $WT$  – 0.4–0.9 cm;  $S$  – slightly coarse;  $CS$  – outer surface: black (7.5YR2.5/1), inner surface: brown (7.5YR6/3);  $CF$  – brown (7.5YR6/3); SU 2191; □ (F 14);  $A$  – XIX;  $F$  – 623;  $T$  – L4;  $Fa$  – VKJ 2

**SU 1978/1979**

**194** A smaller pot with a slightly outward protruding rim and a short neck. The body is merely wider than the rim itself. Handmade vessel with rough and uneven surface (Pl. 22: 1).

$dR$  – 11.1 cm;  $dV$  – 13 cm;  $dN$  – 10.7 cm;  $WT$  – 0.4 cm;  $S$  – coarse;  $CS$  – outer surface: brown (5YR4/1), inner surface: brown (5YR4/2);  $CF$  – brown (5YR4/2); SU 1978; □ (F/G 7/8);  $A$  – XXI;  $F$  – 667;  $T$  – L1;  $Fa$  – VKJ 2

**195** A pot with a wide, slightly outward protruding rim and a very short neck which widens into the rounded shoulder wider than the rim. Made on the wheel (Pl. 22: 2).

$dR$  – 15 cm;  $dN$  – 14.2 cm;  $WT$  – 0.55 cm;  $S$  – coarse, uneven;  $CS$  – outer surface: orange (10YR6/4), inner surface: brown (10YR4/2);  $CF$  – brown (10YR4/2); SU 1978; □ (F/G 7/8);  $A$  – XXI;  $F$  – 648;  $T$  – L1;  $Fa$  – VKJ 2

**196** A pot with a wide, outward protruding, slightly thickened rim. Short neck which widens into a rounded shoulder wider than the rim itself. The vessel is handmade (Pl. 22: 3).

$dR$  – 18 cm;  $dV$  – 21.2 cm;  $dN$  – 17 cm;  $WT$  – 5.5 cm;  $S$  – coarse, uneven;  $CS$  – outer surface: orange (7.5YR6/6), inner surface: gray (7.5YR4/1);  $CF$  – orange (7.5YR6/6) to gray (7.5YR4/1); SU 1978; □ (F/G 7/8);  $A$  – XXI;  $F$  – 648;  $T$  – L2;  $Fa$  – VKJ 2

**197** A larger pot with a wider rim. Obliquely outward protruding rim; very short neck which exceeds into a rounded shoulder. The surface is slightly smoothed and uneven since the vessel is handmade (Pl. 22: 4).

$dR$  – 22 cm;  $dN$  – 21 cm;  $WT$  – 0.4 cm;  $S$  – smooth;  $CS$  – outer surface: brown (7.5YR4/1), inner surface: brown (7.5YR4/2) to black (5Y2.5/1);  $CF$  – brown (7.5YR4/1) to black (5Y2.5/1); SU 1978; □ (F/G 7/8);  $A$  – XXI;  $F$  – 667;  $T$  – L3;  $Fa$  – VKJ 2

**198** A pot with a wide rim. The rim is obliquely protruding outward and slightly thickened; very short neck which immediately exceeds into the wide body with a rounded shoulder. The vessel is handmade (Pl. 22: 5).

$dR$  – 20 cm;  $dN$  – 18.7 cm;  $WT$  – 0.45 cm;  $S$  – coarse, uneven;  $CS$  – outer surface: dark gray (10YR3/1), inner surface: brown (10YR5/3);  $CF$  – dark gray (10YR3/1) to brown (10YR5/3); SU 1978; □ (F/G 7/8);  $A$  – XXI;  $F$  – 648;  $T$  – L3;  $Fa$  – VKJ 2



- 197.** Lonac većih dimenzija, širokog oboda. Obod je koso izvijen prema van, vrat je vrlo kratak i prelazi u zaobljeno rame. Površina je blago zaglađena, neravna, posuda je rađena rukom (T. 22: 4).  
dR – 22 cm; dN – 21 cm; WT – 0,4 cm; St – zaglađena; CS – vani: smeđa (7,5YR4/1), unutra: smeđa (7,5YR4/2) do crna (5Y2,5/1); CF – smeđa (7,5YR4/1) do crna (5Y2,5/1); SJ 1978; □ (F/G 7/8); S – XXI; N – 667; T – L3; Fa –VKJ 2
- 198.** Lonac širokog oboda. Obod je koso izvijen prema van i malo je zadebljan, vrat je vrlo kratak i odmah prelazi u široko tijelo sa zaobljenim ramenom. Posuda je rađena rukom (T. 22: 5).  
dR – 20 cm; dN – 18,7 cm; WT – 0,45 cm; St – hrapava, neravna; CS – vani: tamno siva (10YR3/1), unutra: smeđa (10YR5/3); CF – tamno siva (10YR3/1) do smeđa (10YR5/3); SJ 1978; □ (F/G 7/8); S – XXI; N – 648; T – L3; Fa –VKJ 2
- 199.** Tanjur s kosim stjenkama. Obod je pomalo zaobljen. Stjenka je na dnu posude koje je ravno zadebljana u odnosu na bočne stjenke tanjura. Na posudi nema premaza i slikanja, a površina ima neravnomjernu boju pečenja (T. 22: 6).  
dR – 21,3 cm; dB – 15,1 cm; hV – 4,5 cm; WT – 0,55 – 0,8 cm; St – pomalo hrapava; CS – smeđa do siva (10YR6/2; 10YR3/1; 7,5YR6/4); CF – smeđa do siva (10YR6/2; 10YR3/1; 7,5YR6/4); SJ 1978; □ (F/G 7/8); S – XXI; N – 667; T – T1; Fa –VKJ 2
- 200.** Zdjela ravnog dna i ravnog oboda. Bočne stjenke posude su lagano zaobljene prema van u središnjem dijelu. S unutrašnje strane očuvan je crni premaz, što upućuje da je posuda bila pogodna za držanje tekućeg sadržaja. Površina je neravna i nema tragova izrade na kolu (T. 22: 7).  
dR – 17,5 cm; dB – 9,9 cm; hV – 6,2 cm; WT – 0,54 cm; St – hrapava; CS – vani: crna do tamno smeđa (2,5Y3/1; 5YR4/2), unutra: crna boja pečenja i tragovi crnog premaza (GLEY1 2,5/N); CF – crna (GLEY1 2,5/N); D – premaz na unutrašnjoj strani; SJ 1978; □ (F/G 7/8); S – XXI; N – 648; T – Z1; Fa –VKJ 2
- 201.** Keramička zdjela rađena rukom. Na unutrašnjoj i vanjskoj stjenki nalaze se tragovi premaza pa je za pretpostaviti da je zdjela korištena za serviranje ili kuhanje tekućeg sadržaja. Obod je ravan, neznatno zadebljan prema unutrašnjoj strani. Bočne stjenke su kose i prelaze u ravno dno. Boja je na vanjskoj i unutrašnjoj strani neujednačena (T. 22: 8).  
dR – 18,5 cm; dB – 9 cm; hV – 8 cm; WT – 0,5 cm; St – malo hrapava; CS – vani: smeđe siva (10R5/1), unutra: svijetlo smeđa do crvena (10R6/4); SJ 1978; □ (F/G 7/8); S – XXI; N – 648, 647; T – Z1; Fa –VKJ 2
- 199** A plate with oblique walls. Somewhat rounded rim. The wall at the flat base is thicker than the side walls of the plate. There are no traces of slip or paint on the vessel, and the firing colour of the surface is uneven (Pl. 22: 6).  
dR – 21.3 cm; dB – 15.1 cm; hV – 4.5 cm; WT – 0.55 – 0.8 cm; S – slightly coarse; CS – brown to gray (10YR6/2; 10YR3/1; 7.5YR6/4); CF – brown to gray (10YR6/2; 10YR3/1; 7.5YR6/4); SU 1978; □ (F/G 7/8); A – XXI; F – 667; T – T1; Fa –VKJ 2
- 200** A bowl with a flat base and a straight rim. Side walls of the vessel are slightly curved outward in the middle segment. Black slip is preserved on the inside which indicates that the vessel was suitable for liquids. The surface is uneven and there are no traces of the wheel (Pl. 22: 7).  
dR – 17.5 cm; dB – 9.9 cm; hV – 6.2 cm; WT – 0.54 cm; S – coarse; CS – outer surface: black to dark brown (2.5Y3/1; 5YR4/2), outer surface: black firing colour and traces of black slip (GLEY1 2.5/N); CF – black (GLEY1 2.5/N); D – slip on the inner side; SU 1978; □ (F/G 7/8); A – XXI; F – 648; T – Z1; Fa –VKJ 2
- 201** Ceramic handmade bowl. Traces of slip visible on the outside and on the inside which indicates that the bowl was used for serving or preparing liquid foods. Straight rim, slightly thickened on the inside. Slanting side walls which exceed into the flat base. Colour on the outside and on the inside is uneven (Pl. 22: 8).  
dR – 18.5 cm; dB – 9 cm; hV – 8 cm; WT – 0.5 cm; S – slightly coarse; CS – outer surface: brownish gray (10R5/1), inner surface: light brown to red (10R6/4); SU 1978, □ (F/G 7/8); A – XXI; F – 648, 647; T – Z1; Fa –VKJ 2
- 202** Fragments of a bowl with a slightly inward protruding, rounded rim. The vessel is coarsely crafted. Side walls are slanted (Pl. 22: 9).  
dR – 19 cm; WT – 0.5 cm; CS – brown (7.5YR4/1); CF – brown (7.5YR4/2); SU 1978; □ (F/G 7/8); A – XXI; F – 648, 647; T – Z1; Fa –VKJ 2
- 203** A lid with a straight rim. Slanted side walls (Pl. 23: 1).  
dR – 20 cm; WT – 0.5 cm; S – coarse; CS – red to brown (2.5YR5/8–5/2); CF – red to brown (2.5YR2.5/1–4/2); SU 1978; □ (F/G 7/8); A – XXI; F – 667; T – P2; Fa –VKJ 2
- 204** A lid with a straight rim and walls slightly curved outward in its lower segment. Smoothened outer and inner surface (Pl. 23: 2).  
dR – 20 cm; WT – 0.6 cm; S – smoothed; CS – orange (10YR6/4) to brown (7.5YR4/1); CF – orange (10YR6/4) to brown (7.5YR4/1); SU 1978; □ (F/G 7/8); A – XXI; F – 648; T – P3; Fa –VKJ 2
- 205** A lid with a wide flat handle with a triangular cross-



- 202.** Ulomci zdjele, blago uvučenog oboda, zaobljenog ruba. Posuda je grube izrade, bočne stijenke su ukošene (T. 22: 9).  
*dR* – 19 cm; *WT* – 0,5 cm; *CS* – smeđa (7,5YR4/1); *CF* – smeđa (7,5YR4/2); *SJ* 1978; □ (F/G 7/8); *S* – XXI; *N* – 648, 647; *T* – Z1; *Fa* – VKJ 2
- 203.** Poklopac s ravnim obodom. Bočne stijenke su ukošene (T. 23: 1).  
*dR* – 20 cm; *WT* – 0,5 cm; *St* – hrapava; *CS* – crvena do smeđa (2,5YR5/8–5/2); *CF* – crvena do smeđa (2,5YR2,5/1–4/2); *SJ* 1978; □ (F/G 7/8); *S* – XXI; *N* – 667; *T* – P2; *Fa* – VKJ 2
- 204.** Poklopac čiji je obod ravan, stijenke su blago zaobljene prema van u donjem dijelu poklopca. Vanjska i unutrašnja stjenka su zaglađene (T. 23: 2).  
*dR* – 20 cm; *WT* – 0,6 cm; *St* – zaglađena; *CS* – narančasta (10YR6/4) do smeđa (7,5YR4/1); *CF* – narančasta (10YR6/4) do smeđa (7,5YR4/1); *SJ* 1978; □ (F/G 7/8); *S* – XXI; *N* – 648; *T* – P3; *Fa* – VKJ 2
- 205.** Poklopac sa širokom ravnom drškom trokutastog presjeka. Tijelo se konično širi prema obodu (T. 23: 3).  
*WT* – 0,6 cm; *St* – hrapava; *CS* – tamno siva (10YR3/1); *CF* – tamno siva (10YR3/1); *dH* – 5,7 cm; *SJ* 1978; □ (F/G 7/8); *S* – XXI; *N* – 667; *T* – P?; *Fa* – VKJ 2
- 206.** Poklopac sa širokom drškom, blagog prijelaza u tijelo koje se jako širi u obod (T. 23: 4).  
*WT* – 0,6–1 cm; *St* – neravna, rađena rukom; *CS* – tamno siva (10YR3/1); *CF* – tamno siva (10YR3/1); *dH* – 6 cm; *SJ* 1978; □ (F/G 7/8); *S* – XXI; *N* – 667; *T* – P; *Fa* – VKJ 2
- 207.** Ulomak drške vrlo grube i nekvalitetne izrade. Na donjem dijelu očuvana je manja istaka kojom je drška bila učvršćena za tijelo posude (koja je imala rupu na mjestu spoja s drškom) (T. 23: 5).  
*dH* – 2,3 x 1 cm; *CS* – smeđe siva (2,5YR5/1–7,5YR6/4); *CF* – smeđa (7,5YR5/6); *SJ* 1978; □ (F/G 7/8); *S* – XXI; *N* – 667; *T* – ?; *Fa* – VKJ 2
- 208.** Ulomak zdjele tankih stijenki. Obod je šiljato oblikovan, s vanjske strane nalaze se dva vodoravna plitka žlijeba. Nema tragova premaza. Struktura je istovjetna strukturi čaše kat. br. 116. (T. 23: 6).  
*WT* – 0,2 cm; *CS* – oker (7,5YR8/4), u donjem dijelu ima oker premaz nešto tamniji od boje pečenja (7,5YR6/4); *CF* – oker (7,5YR8/4); *St* – glatka; *D* – dva plitka žlijeba ispod oboda s vanjske strane; *SJ* 1978; □ (F/G 7/8); *S* – XXI; *N* – 667; *T* – L5?; *Fa* – pročišćena glina bez primjesa
- section. The body conically widens toward the rim (Pl. 23: 3).  
*WT* – 0.6 cm; *S* – coarse; *CS* – dark gray (10YR3/1); *CF* – dark gray (10YR3/1); *dH* – 5.7 cm; *SU* 1978; □ (F/G 7/8); *A* – XXI; *F* – 667; *T* – P?; *Fa* – VKJ 2
- 206** A lid with a wide handle which mildly exceeds into the body which strongly widens into the rim (Pl. 23: 4).  
*WT* – 0.6 – 1 cm; *S* – uneven, handmade; *CS* – dark gray (10YR3/1); *CF* – dark gray (10YR3/1); *dH* – 6 cm; *SU* 1978; □ (F/G 7/8); *A* – XXI; *F* – 667; *T* – P; *Fa* – VKJ 2
- 207** Fragment of a very coarse, poorly crafted handle. On the lower part, a small projection is preserved by which the handle was connected to the body of the vessel (there was a hole on the vessel on the connection point) (Pl. 23: 5).  
*dH* – 2.3 x 1 cm; *CS* – brownish gray (2.5YR5/1–7.5YR6/4); *CF* – brown (7.5YR5/6); *SU* 1978; □ (F/G 7/8); *A* – XXI; *F* – 667; *T* – ?; *Fa* – VKJ 2
- 208** Fragment of a thin-walled vessel. Pointy-shaped rim with two horizontal shallow grooves on the outside. No traces of slip. The fabric is the same as the fabric of a cup Cat. No. 116. (Pl. 23: 6).  
*WT* – 0.2 cm; *CS* – ochre (7.5YR8/4), in the lower part there is an ochre slip slightly darker than the firing colour (7.5YR6/4); *CF* – ochre (7.5YR8/4); *S* – smooth; *D* – two shallow grooves under the rim on the outer side; *SU* 1978; □ (F/G 7/8); *A* – XXI; *F* – 667; *T* – L5?; *Fa* – purified clay without inclusions
- SU 2149/2150**
- 209** A pot with a somewhat emphasized, slightly outward protruding rim. Very short neck immediately exceeding into the unemphasised shoulder. The body is slightly wider than the rim; the vessel is poorly handmade of unrefined clay; there is no foot, only a flat base. There are no traces of the wheel. There are no traces of slip or paint neither on the inside nor on the outside. The vessel follows local prehistoric traditions with its shape (Pl. 23: 8).  
*dR* – 19.6 cm (uneven due to being handmade); *dB* – 16 cm; *dV* – 24 cm; *dN* – 18.7 cm; *hV* – 19 cm; *WT* – 6 – 7 mm (uneven); *S* – without special treatment, slightly coarse; *CS* – reddish brown, uneven firing colour (5YR5/4; 5YR 4/2); *CF* – reddish brown, uneven firing colour (5YR5/4; 5YR 4/2); *SU* 2149; □ (D/E 10/11); *A* – XX; *F* – 660; *T* – L1; *Fa* – VKJ 19
- 210** A pot with a slightly protruding rim, somewhat thickened on the outside. The neck is short and hardly emphasized and the body is somewhat wider than the rim. The vessel is handmade without slip and is made

**SJ 2149/2150**

**209.** Lonac s obodom koji je neznatno naglašen tako što je malo izvijen prema van. Vrat je jako kratak, brzo prelazi u nenaglašeno rame. Trbuh je neznatno širi od oboda, posuda nema nogu, već ravno dno. Nema tragova rada na kolu, posuda je rađena rukom, od nepročišćene gline i dosta je nepravilna. Na posudi s unutrašnje i vanjske strane nema tragova nikakvih premaza ni slikanja. Posuda se svojim oblikom nastavlja na lokalne prapovijesne tradicije (T. 23: 8).

*dR* – 19,6 cm (neujednačeno jer je rađeno rukom); *dB* – 16 cm; *dV* – 24 cm; *dN* – 18,7 cm; *hV* – 19 cm; *WT* – 6–7 mm (promjenjiva); *St* – bez posebne obrade, pomalo hrapava; *CS* – crveno smeđa, nejednake boje pečenja (5YR5/4; 5YR4/2); *CF* – crveno smeđa, nejednake boje pečenja (5YR5/4; 5YR4/2); *SJ* 2149; □ (D/E 10/11); *S* – XX; *N* – 660; *T* – L1; *Fa* – VKJ 19

**210.** Lonac neznatno izvijenog oboda koji je samo blago zadebljan prema vanjskoj strani. Vrat je kratak i jedva naglašen, a tijelo je nešto šire od oboda. Posuda je rađena rukom, nema premaza i izrađena je od gline koja nije pročišćena i ima malo primjesa (T. 24: 1).

*dR* – 16,4 cm; *dN* – 15,8 cm; *S* – neravna, malo hrapava; *CS* – vani: oker (10YR7/2), unutra: tamno siva (GLE Y1 4/N); *CF* – tamno siva (GLE Y1 4/N); *SJ* 2149; □ (D/E 10/11); *S* – XX; *N* – 660; *T* – L1; *Fa* – VKJ 2

**211.** Lonac s blago izvijenim obodom prema vanjskoj strani. Vrat je kratak i odmah prelazi u zaobljeno tijelo. Površina je neravna, posuda nije rađena na kolu, glina je nepročišćena s malo primjesa (T. 24: 2).

*dR* – 19,1 cm; *dV* – 21 cm; *dN* – 18,6 cm; *hV* – više od 9 cm; *WT* – 6–7 cm; *St* – neravna, malo hrapava; *CS* – vani: crveno smeđa (10YR6/3), unutra: oker (2,5Y7/3); *CF* – oker (2,5Y7/3), crveno smeđa (10YR6/3); *SJ* 2149; □ (D/E 10/11); *S* – XX; *N* – 660; *T* – L1; *Fa* – VKJ 19

**212.** Lonac blago izvijenog oboda koji je prema van nejednako zadebljan. Vrat je kratak i prelazi u trbuh neznatno širi od oboda. Posuda nije rađena na kolu, izrađena je od nepročišćene gline s primjesama (T. 24: 3).

*dR* – 14,2 cm; *dV* – 16 cm; *dN* – 13,6 cm; *WT* – 0,4–0,5 cm; *St* – neravna, malo hrapava; *CS* – unutra: smeđa (7,5YR6/4), vani: tamno smeđa do siva (GLE Y1 4/N); *CF* – crna (GLE Y1 2,5/N); *SJ* 2149; □ (D/E 10/11); *S* – XX; *N* – 660; *T* – L2; *Fa* – VKJ 2

**213.** Ulomak zdjele od pročišćene gline s tragovima crnog premaza na unutrašnjoj i vanjskoj strani. Obod je ravan i prema vanjskoj strani zaobljen. Ispod ruba na vanjskoj strani nalazi se vodoravni uski žlijeb (T. 24: 4a–4b).

*dR* – 22 cm; *WT* – 0,4–0,6 cm; *St* – glatka, s tragovima

of unrefined clay with scarce inclusions (Pl. 24: 1).

*dR* – 16.4 cm; *dN* – 15.8 cm; *S* – uneven, slightly coarse; *CS* – outer surface: ochre (10YR7/2), inner surface: dark gray (GLE Y1 4/N); *CF* – dark gray (GLE Y1 4/N); *SU* 2149; □ (D/E 10/11); *A* – XX; *F* – 660; *T* – L1; *Fa* – VKJ 2

**211** A pot with a slightly outward protruding rim. Short neck which immediately exceeds into a rounded body. Uneven surface; the vessel is not made on the wheel; clay unrefined with scarce inclusions (Pl. 24: 2).

*dR* – 19.1 cm; *dV* – 21 cm; *dN* – 18.6 cm; *hV* – > 9 cm; *WT* – 6–7 cm; *S* – uneven, slightly coarse; *CS* – outer surface: reddish brown (10YR6/3), inner surface: ochre (2.5Y7/3); *CF* – ochre (2.5Y7/3), reddish brown (10YR6/3); *SU* 2149; □ (D/E 10/11); *A* – XX; *F* – 660; *T* – L1; *Fa* – VKJ 19

**212** A pot with a slightly protruding rim, unevenly thickened on the outside. Short neck which exceeds into the body which is somewhat wider than the rim. The vessel was not made on the wheel, and it was made of unrefined clay with inclusions (Pl. 24: 3).

*dR* – 14.2 cm; *dV* – 16 cm; *dN* – 13.6 cm; *WT* – 0.4–0.5 cm; *S* – uneven, slightly coarse; *CS* – inner surface: brown (7.5YR6/4), outer surface: dark brown to gray (GLE Y1 4/N); *CF* – black (GLE Y1 2.5/N); *SU* 2149; □ (D/E 10/11); *A* – XX; *F* – 660; *T* – L2; *Fa* – VKJ 2

**213** Fragment of a bowl made of purified clay, with traces of black slip on the inside and on the outside. The rim is straight, rounded outward. Narrow, horizontal groove, on the outside, under the rim (Pl. 24: 4a–4b).

*dR* – 22 cm; *WT* – 0.4 – 0.6 cm; *S* – smooth, with traces of black slip; *CS* – gray (2.5Y7/1–6/1) with black slip (GLE Y2 2.5/5PB); *CF* – gray (GLE Y2 5/10B); *D* – thick black slip on both surfaces, on the outer surface, under the rim there is a horizontal incised line; *SU* 2149; □ (D/E 10/11); *A* – XX; *F* – 660; *T* – bowl; *Fa* – VKJ 21

**214** Fragment of a vessel with a horizontally protruding rim with rounded edge. The rim is on its upper part, next to the edge, profiled with a shallow groove. It is a well fired, quality crafted vessel (Pl. 24: 5).

*WT* – 0.7 cm; *CS* – orange (7.5YR7/6); *CF* – orange to gray (7.5YR6/4–7/1); *SU* 2149; □ (D/E 10/11); *A* – XX; *F* – 660; *T* – Z?; *Fa* – VKJ 13

**Hearth****SU 437/438**

**215** A big pot with an outward protruding, thickened rim.

The rim itself is not evenly thick as it is crafted as rough and as irregular as the whole pot. The fabric of the vessel is very coarse and hard, the clay is unrefined and contains a lot of large inclusions of quartz and mica (up to 7 mm). Below the rim a somewhat narrower neck mildly exceeds into the body which is not wider than



gustog crnog premaza; CS – siva (2,5Y7/1–6/1) sa crnim premazom (GLE2 2,5/5PB); CF – siva (GLE2 5/10B); D – gusti crni premaz na vanjskoj i unutrašnjoj strani, s vanjske strane ispod oboda nalazi se vodoravno urezana linija; SJ – 2149; □ (D/E 10/11); S – XX; N – 660; T – zdjela; Fa – VKJ 21

**214.** Ulomak posude vodoravno izvijenog oboda, zaobljenog ruba. Obod je s gornje strane profiliran plitkim žlijebom, tik uz rub. Kvalitetne izrade, dobro pečena (T. 24: 5).

WT – 0,7 cm; CS – narančasta (7,5YR7/6); CF – narančasta do siva (7,5YR6/4–7/1); SJ – 2149; □ (D/E 10/11); S – XX; N – 660; T – Z?; Fa – VKJ 13

### Ognjište

#### SJ 437/438

**215.** Veliki lonac s obodom koji je izvijen prema van te zadebljan. Sam rub nije jednake debljine, izveden je grubo i nepravilno kao i cijela posuda. Struktura posude je vrlo gruba, tvrda, glina je nepročišćena i sadrži mnogo krupnih primjesa kvarca i tinjca (do 7 mm). Ispod oboda nalazi se nešto uži vrat koji blago prelazi u trbuh koji svojom širinom ne prelazi širinu oboda. Zbog velike količine primjesa kvarca i tinjca posuda je vjerojatno služila za kuhanje (T. 24: 8).

dR – 36 cm; dV – 34,2 cm; dN – 31,8 cm; hV – više od 24 cm; WT – 0,8 cm; St – vrlo gruba; CS – crvena (5YR5/4) do smeđa (10YR3/1); CF – crvena (5YR5/4) do smeđa (10YR3/1); D – rame i gornji dio trbuha ukrašeni su češljastim ukrasom povučenim od lijeva gore prema desno dolje; SJ 437; □ R/S 23; S – VIII; PN – 23; T – L6; Fa – VKJ 24

**216.** Lonac većih dimenzija širokog oboda. Obod je izvijen prema van i koso je odrezan, vrat nije naglašen, a tijelo se koso širi prema trbuhu. Na prijelazu iz vrata u rame nalazi se vodoravna urezana linija. Površina lonca je gruba i hrapava (T. 25: 1).

dR – 26 cm; dV – veći od 36 cm; dN – 24 cm; WT – 1 cm; St – hrapava i gruba; CS: vani: neujednačena, crvena, svijetlo smeđa, krem (7,5YR7/3; 2,5YR6/6), unutra: neujednačena, siva, smeđa (5YR5/6; 10YR7/3; 10YR5/2); CF – neujednačena, siva, smeđa, crvena (10YR5/2; 7,5YR7/3; 2,5YR6/6); D – vodoravni urez na prijelazu vrata u rame; SJ 437; □ R/S 23; S – VIII; N – 297; T – L8; Fa – VKJ 28

**217.** Dno posude na nozi od tere sigilate. Noga je ukošena prema van, dno je također ukošeno s najnižim dijelom u sredini. S vanjske strane djelomično je očuvan sjajni, postojani tamnocrveni premaz. Ulomak je stradao u sekundarnom gorenju i gornja strana je jako oštećena i oguljena (T. 25: 2).

the rim. The large quantity of inclusions of quartz and mica indicates that the vessel was probably used for cooking (Pl. 24: 8).

dR – 36 cm; dV – 34.2 cm; dN – 31.8 cm; hV – >24 cm; WT – 0.8 cm; S – very coarse; CS – red (5YR5/4) to brown (10YR3/1); CF – red (5YR5/4) to brown (10YR3/1); D – shoulder and the upper part of the body are decorated with combed decoration which extends from the upper left part toward the lower right part; SU 437; □ R/S 23; A – VIII; SF – 23; T – L6; Fa – VKJ 24

**216** A large pot with a wide rim. The rim is obliquely cut and protruding outward; the neck is not emphasized and the body widens slanting. Horizontal incised line on the transition from the neck into the shoulder. The surface of the pot is coarse and rough (Pl. 25: 1).

dR – 26 cm; dV – >36 cm; dN – 24 cm; WT – 1 cm; S – coarse and rough; CS: outer surface: uneven, red, light brown (7.5YR7/3; 2.5YR6/6), inner surface: uneven, gray, brown (5YR5/6; 10YR7/3; 10YR5/2); CF – uneven, gray, brown, red (10YR5/2; 7.5YR7/3; 2.5YR6/6); D – horizontal incision between the neck and the shoulder; SU 437; □ R/S 23; A – VIII; F – 297; T – L8; Fa – VKJ 28

**217** *Terra sigillata* base of a footed vessel. The foot is slanting outward and the base is also oblique with its lowest part being its centre. Partially preserved glossy, consistent dark red slip on the outer wall. Fragment was damaged during secondary firing and therefore its upper segment is severely damaged and peeled (Pl. 25: 2).

dF – 9.4 cm; WT – 0.6 cm; CS – orange (2.5YR7/6), red (10R5/8); CF – orange (2.5YR6/6); D – thick, glossy slip; SU 437; □ R/S 23; A – VIII; F – 297; T – Z?; Fa – purified clay, with very small inclusions visible under magnifier

### Layers

#### SU 001

**218** A large vessel for food storage - dolium. Handmade of unrefined clay with scarce inclusions. The rim is slightly protruding outward and the neck is short and it immediately exceeds into a rounded shoulder which widens strongly toward the body which is not preserved in its widest segment. Black slip on the outside of the vessel which indicates that it could have been used for storing liquids. On the inner wall partially visible traces of wooden potters spatula used for moulding of the vessel (Pl. 26: 1).

dR – 21 cm; dV – >28 cm; dN – 19.7 cm; WT – 0.6 cm; S – smoothed, uneven colour of the firing; CS – outer surface: black (10YR3/1–2/1), inner surface: brown (7.5YR5/2); CF – reddish brown (5YR5/6); SU 001; A – XV, □ ?; F – 307; T – dolium; Fa – VKJ 2



dF – 9,4 cm; WT – 0,6 cm; CS – narančasta (2,5YR7/6), crvena (10R5/8); CF – narančasta (2,5YR6/6); D – tamni, sjajni gusti premaz; SJ 437; □ R/S 23; S – VIII; N – 297; T – Z?; Fa – pročišćena glina, s vrlo sitnim primjesama koje se uočavaju kod uvećanja

## Slojevi

### SJ 001

**218.** Posuda većih dimenzija za čuvanje hrane–dolij. Rađena je rukom od nepročišćene gline s malo primjesa. Obod je blago izvijen prema van, vrat je kratak i odmah prelazi u zaobljeno rame koje se jako širi u trbuh koji nije sačuvan u svom najširem dijelu. Na posudi se na vanjskoj stijenki nalazi premaz crne boje te je ona mogla služiti i za čuvanje tekućeg sadržaja. Djelomično su vidljivi tragovi upotrebe drvenih spatula kod obrade posude na unutrašnjoj stijenki (T. 26: 1).

dR – 21 cm; dV – više od 28 cm; dN – 19,7 cm; WT – 0,6 cm; St – zaglađena, ujednačene boje pečenja; CS – vani: crna (10YR3/1–2/1), unutra: smeđa (7,5YR5/2); CF – crveno smeđa (5YR5/6); SJ 001; □ ?; S – XV; N – 307; T – dolij; Fa –VKJ 2

### SJ 002

**219.** Tanjur ravnog dna i blago zaobljenog i neizraženog oboda. Bočne stijenke su ukošene. S unutrašnje strane nalazi se crni premaz zbog kojeg je moguće da je posuda sadržavala tekući sadržaj (T. 26: 12).

dR – 22,6 cm; dB – 16,5 cm; hV – 5 cm; WT – 0,65 cm; St – malo hrapava, na mjestima gdje je očuvan premaz na unutrašnjoj strani je glatka; CS – vani: smeđe siva do crna (GLEY1 3/N; 5YR5/1), unutra: tamno siva do crna (10YR3/1–2/1); CF – sivo crna (10YR3/1–2/1); D – s unutrašnje strane nalazi se crni premaz; SJ 002; □ X 28; N – 110; T – T1; Fa – VKJ 2

### SJ 424

**220.** Lonac s vodoravno izvijenim obodom, kratkim i naglašenim vratom te ramenom koje se jako širi. Prijelaz iz vrata u rame je naglašen vodoravnim urezom. Glina je nepročišćena s krupnim primjesama. Nema tragova premaza. Na vodoravnom obodu uz vanjski rub nalazi se koncentrično urezana linija, vjerojatno za pridržavanje poklopca (T. 27: 1).

dR – 11,1 cm; dN – 9,9 cm; WT – 0,5 cm; St – gruba, hrapava; CS – CF – tamno siva (GLEY1 4/N); SJ 424; □ U 25/26, V 25; S –VII; N – 284; T – L2; Fa – VKJ 25

**221.** Lonac s koso izvijenim obodom prema van čija je stjenka zadebljana u odnosu na tijelo. Vrat je kratak i koso se širi prema tijelu. Površina je neravna i malo hrapava, lonac nije rađen na kolu, a ima tragove premaza (T. 27: 2).

dR – 16 cm; dN – 14,5 cm; WT – 0,45–0,85 cm; St – hra-

### SU 002

**219** (T 26: 12) Flat-based plate with a slightly rounded unemphasised rim. Slanted side walls. Since there is black slip on the inside it can be assumed that the vessel was used for storing liquids.

dR – 22,6 cm; dB – 16,5 cm; hV – 5 cm; WT – 0,65 cm; S – slightly coarse, smooth in places on the inside where slip was preserved; CS – outer surface: brown-gray to black (GLEY1 3/N; 5YR5/1), inner surface: dark gray to black (10YR3/1–2/1); CF – gray-black (10YR3/1–2/1); D – black slip on the inner surface; SU 002; □ X 28; F – 110; T – T1; Fa – VKJ 2

### SJ 424

**220** A pot with a horizontally protruding rim, short and emphasized neck, and a strongly widening shoulder. The transition from the neck into the shoulder is emphasized by a horizontal incision. Clay is unrefined with large inclusions. There are no traces of slip. Concentric incised line on the horizontal rim, next to the outer edge, probably for the purpose of holding the lid (Pl. 27: 1).

dR – 11.1 cm; dN – 9.9 cm; WT – 0.5 cm; S – coarse, rough; CS – CF – dark gray (GLEY1 4/N); SU 424; □ U 25/26, V 25; A – VII; F – 284; T – L2; Fa – VKJ 25

**221** A pot with an obliquely outward protruding rim with walls thicker than the walls of the body. Short neck widens slanting toward the body. Uneven and slightly rough surface. The pot was not made on the wheel. Visible traces of slip (Pl. 27: 2).

dR – 16 cm; dN – 14.5 cm; WT – 0.45 – 0.85 cm; S – coarse; CS – outer surface: brown (7.5Y7/4), inner surface: dark gray (GLEY1 4/N); CF – dark gray (GLEY1 4/N); SU 424; □ U 25/26, V 25; A – VII; F – 284; T – L4; Fa – VKJ 2

**222** A bowl with a straight rim, not made on the wheel. Uneven surface, with black slip on the inside indicates that the bowl was used for serving or storing liquids. Side walls taper toward the base and are slightly curved (Pl. 27: 3).

dR – 19 cm; WT – 0.95 cm; S – uneven, inner surface with black slip; CS – outer surface: brown (10YR 6/3) to dark gray (GLEY1 4/N); inner surface: dark gray (GLEY1 4/N) with black slip (GLEY1 3/N); CF – dark gray (GLEY1 4/N); D – black slip on inner surface; SU 424; □ U 25/26, V 25; A – VII, F – 284; T – Z1; Fa – VKJ 2

### SU 504

**223** A pot with an obliquely outward protruding, slightly thickened rim, triangular in cross-section. The neck is short and widens into the body which is only slightly wider than the rim itself. Rounded shoulder (Pl. 27: 6).

dR – 17 cm; dV – 18.7 cm; dN – 15.6 cm; WT – 0.2 – 0.6 cm; S – coarse; CS – CF – brown (7.5YR5/2 brown); SU



pava; CS – vani: smeđa (7,5Y7/4), unutra: tamno siva (GLE Y1 4/N); CF – tamno siva (GLE Y1 4/N); SJ 424; □ U 25/26, V 25; S – VII; N – 284; T – L4; Fa – VKJ 2

**222.** Zdjela ravnog oboda koja nije rađena na kolu, površina je neravna, unutrašnja strane premazana je crnim premazom te se koristila za serviranje ili kuhanje tekućeg sadržaja. Bočne stijenke sužavaju se prema dnu i neznatno su zaobljene (T. 27: 3).

dR – 19 cm; WT – 0,95 cm; St – neravna, unutrašnja s crnim premazom; CS – vani: smeđa (10YR 6/3) do tamno siva (GLE Y1 4/N); unutra: tamno siva (GLE Y1 4/N) sa crnim premazom (GLE Y1 3/N); CF – tamno siva (GLE Y1 4/N); D – unutrašnja strana ima crni premaz; SJ 424; □ U 25/26, V 25; S – VII; N – 284; T – Z1; Fa – VKJ 2

### SJ 504

**223.** Lonac s obodom koji je koso izvijen prema van, malo je zadebljan i trokutast u presjeku. Vrat je kratak i širi se u tijelo neznatno šire od samog oboda, a rame je zaobljeno (T. 27: 6).

dR – 17 cm; dV – 18,7 cm; dN – 15,6 cm; WT – 0,2–0,6 cm; St – hrapava; CS – CF – smeđa (7,5YR5/2); SJ 504; □ H/I 8/7, I 6; S – XII; N – 337; T – L3; Fa – VKJ 2

### SJ 1018

**224.** Ulomak lonca ukošenog oboda. Rub oboda je koso odrezan i blago profiliran. Rame je ukošeno (T. 28: 1).

dR – 22,2 cm; dN – 20,7 cm; WT – 0,8 cm; CS – narančasta do smeđa (5YR6/4–6/1); CF – narančasta (5YR5/6); SJ 1018; □ (L/K 25/27); S – XVII; N – 414; T – L4; Fa – VKJ 2

**225.** Zdjela ravnog oboda. Stijenke se blago zaobljeno sužavaju prema dnu. Na posudi nema tragova prema za ni ukrasa, rađena je na kolu od nepročišćene gline s vrlo malo premaza. Nejednake boje pečenja (T. 28: 2).

dR – 20,2 cm; hV – više od 4 cm; WT – 0,4–0,9 cm; St – glatka; CS – vani: siva (7,5YR2,5/1), smeđa (7,5YR6/4), unutra: smeđa (7,5YR4/1); CF – smeđa (7,5YR6/4), siva (7,5YR2,5/1); SJ 1018; □ (L/K 25/27); S – XVII; N – 414; T – Z1; Fa – VKJ 2

**226.** Drška poklopca grube i nepravilne izrade (T. 28: 3).

dH – 4,7 cm; WT – 0,9 cm; CS – smeđa (5YR4/1); CF – smeđa (5YR4/2); SJ 1018; □ (L/K 25/27); S – XVII; N – 414; T – P?; Fa – VKJ 2

**227.** Dno zdjele na nozi. Noga je ukošena, dno je ravno, a bočne stijenke su zaobljene (T. 28: 4).

dF – 7,2 cm; WT – 1 cm; CS – smeđa (2,5YR6/4); CF – siva u sredini, smeđa uz rubove (2,5YR7/1–2,5YR5/6); SJ 1018; □ (L/K 25/27); S – XVII; N – 414; T – Z?; Fa – VKJ 2

**228.** Ulomak zdjele crveno pečene keramike. Obod je zadebljan, ukošenog ruba s vanjske strane. Posuda je pravilne i kvalitetne izrade. Ispod oboda na vanjskoj strani nalazi se vodoravni plitki žlijeb. Bočne stijenke su blago

504; □ H/I 8/7, I 6; A – XII; F – 337; T – L3; Fa – VKJ 2

### SU 1018

**224** Fragment of a pot with an oblique rim. The edge of the rim is obliquely cut and slightly profiled. Slanting shoulder (Pl. 28: 1).

dR – 22.2 cm; dN – 20.7 cm; WT – 0.8 cm; CS – orange to brown (5YR6/4–6/1); CF – orange (5YR5/6); SU 1018; □ (L/K 25/27); A – XVII; F – 414; T – L4; Fa – VKJ 2

**225** A bowl with a straight rim. Side walls are slightly curved and taper toward the base. There are no traces of slip or decorations on the vessel. It was made on the wheel of purified clay. Uneven firing colour (Pl. 28: 2).

dR – 20.2 cm; hV – > 4 cm; WT – 0.4 – 0.9 cm; S – smooth; CS – outer surface: gray (7.5YR2.5/1), brown (7.5YR6/4), inner surface: brown (7.5YR4/1); CF – brown (7.5YR6/4), gray (7.5YR2.5/1); SU 1018; □ (L/K 25/27); A – XVII; F – 414; T – Z1; Fa – VKJ 2

**226** Coarse, irregularly crafted handle of a lid (Pl. 28: 3).

dH – 4.7 cm; WT – 0.9 cm; CS – brown (5YR4/1); CF – brown (5YR4/2); SU 1018; □ (L/K 25/27); A – XVII; F – 414; T – P?; Fa – VKJ 2

**227** The base of a footed bowl. Slanted foot, flat base, curved side walls (Pl. 28: 4).

dF – 7.2 cm; WT – 1 cm; CS – brown (2.5YR6/4); CF – gray in the middle, brown toward the surface (2.5YR7/1–2.5YR5/6); SU 1018; □ (L/K 25/27); A – XVII; F – 414; T – Z?; Fa – VKJ 2

**228** Fragment of a red fired bowl. Thickened rim with an oblique edge on the outer side. Properly and quality crafted vessel. Horizontal shallow groove on the outside, below the rim. Slightly slanting side walls (Pl. 28: 5).

WT – 0.6 cm; CS – orange (7.5YR8/7); CF – orange (5YR7/6); SU 1018; □ (L/K 25/27); A – XVII; F – 414; T – Z?; Fa – VKJ 13

**229** Fragment of a *terra siggillata* bowl. Fragment of the side wall is preserved. Glossy, thick, partially preserved slip (Pl. 28: 6).

WT – 0.7 cm; CS – orange to red (10R7/8–10R5/6/4/6); CF – orange (2.5YR7/6); D – dark red glossy slip; SU 1018; □ (L/K 25/27); A – XVII; F – 414; T – Z?; Fa – purified clay with very small inclusions visible under magnifier

### SU 1950

**230** The rim of a pot, outward protruding and rounded. Short neck, hardly emphasized by a horizontal incised line on the transition from the rim into the shoulder. The side walls of the shoulder are thinner than the side walls of the rim and of the neck. There are no traces of



ukošene (T. 28: 5).

WT – 0,6 cm; CS – narančasta (7,5YR8/7); CF – narančasta (5YR7/6); SJ 1018; □ (L/K 25/27); S – XVII; N – 414; T – Z?; Fa – VKJ 13

**229.** Ulomak zdjele izrađene od tere sigilate. Očuvan je ulomak bočne stijenke. Premaz je sjajan, gust i djelomično očuvan (T. 28: 6).

WT – 0,7 cm; CS – narančasta do crvena (10R7/8–10R5/6/4/6); CF – narančasta (2,5YR7/6); D – tamnocrveni sjajni premaz; SJ 1018; □ (L/K 25/27); S – XVII; N – 414; T – Z?; Fa – pročišćena glina s vrlo sitnim primjesama koje se uočavaju kod uvećanja

### SJ 1950

**230.** Obod lonca koji je izvijen prema van i zaobljen. Vrat je kratak i jedva naglašen vodoravnom urezanom linijom na prijelazu iz oboda u rame. Stijenke ramena su tanje od stijenki oboda i vrata. Nema tragova premaza na vanjskoj i unutrašnjoj strani (T. 28: 10).

$dR$  – 22,2 cm;  $dN$  – 20,6 cm; WT – 0,3–0,6 cm; St – malo hrapava; CS – vani: smeđe siva (10YR5/3), unutra: tamno siva (10YR3/1); CF – tamno siva (10YR3/1); SJ 1950; □ (G 8/9/10); S – XXI; N – 1584; T – L3; Fa – VKJ 2

**231.** Ulomak trbuha i drške lonca. Trbuh je zaobljen, drška je ovalna u presjeku. Na površini su očuvani tragovi tankog premaza (T. 28: 11).

$dH$  – 2,2x1,5 cm; WT – 0,5 cm; CS – siva (2,5Y8/2); CF – siva (GLE1 7/N); SJ 1950; □ (G 8/9/10); S – XXI; N – 1584; T – vrč?; Fa – VKJ 4

### Katalog keramičkih utega i pršljena

**1.** Pršljen ravnog dna koji je zaobljen u presjeku i sužava se prema gornjem dijelu. Izrađen je od nepročišćene gline s primjesama kvarca i tinjca (T. 14: 2).

$d$ : 4 cm;  $h$ : 2,5 cm;  $d$ rupe: 1,2 cm;  $m$ : 0,44 kg  
SJ 194; □ N 30; S – VII; PN – 15; 3.–4. st.

**2.** Pršljen čija su gornja i donja strana ravne, bočne stijenske su blago zaobljene (T. 15: 5).

$d$ : 2,8 cm u rekonstrukciji;  $h$ : 1,3 cm;  $d$ rupe: 1,2 cm;  $m$ : 0,012 kg (nerekonstruiran)  
SJ 368; □ M 27; S – VII; PN – 18

**3.** Uteg za tkalački stan u obliku krnjog stošca, izrađen od pjeskovite gline. Površina je ukrašena ubodima (T. 19: 8).

$ddna$ : 8,8 cm;  $dvrha$ : 4,5 cm;  $h$ : 9,2 cm;  $d$ rupe: 1,2 cm;  $m$ : 0,6 kg  
SJ 1363; □ (J 24/25); S – XVII; PN – 46; 1. četvrtina 5. st.

**4.** Uteg za tkalački stan u obliku krnje piramide, izrađen od pjeskovite gline (T. 19: 9).

Dim. dna: 4,6 x 4,2 cm;  $h$ : 9,5 cm;  $d$ rupe: 9 mm;  $m$ : 0,332 kg  
SJ 1363; □ (J 24/25); S – XVII; PN – 47; 1. četvrtina 5. st.

slip either on the outer or on the inner surface (Pl. 28: 10).

$dR$  – 22.2 cm;  $dN$  – 20.6 cm; WT – 0.3 – 0.6 cm; S – slightly coarse; CS – outer surface: brownish gray (10YR5/3), inner surface: dark gray (10YR3/1); CF – dark gray (10YR3/1); SU 1950; □ (G 8/9/10); A – XXI; F – 1584; T – L3; Fa – VKJ 2

**231** Fragment of the body and the handle of a pot. Rounded body; handle oval in cross-section. Traces of thin slip preserved on the surface (Pl. 28: 11).

$dH$  – 2.2x1.5 cm; WT – 0.5 cm; CS – gray (2.5Y8/2); CF – gray (GLE1 7/N); SU 1950; □ (G 8/9/10); A – XXI; F – 1584; T – flagon?; Fa – VKJ 4

### Catalogue of ceramic loom weights and whorls

**1** Whorl with a flat base, rounded in cross-section, tapering toward its upper segment.

Made out of unrefined clay with inclusions of quartz and mica (Pl. 14: 2).

$d$ : 4 cm;  $h$ : 2.5 cm;  $d$  of the hole: 1.2 cm;  $m$ : 0.44 kg  
SU 194; □ N 30; A – VII; SF – 15; 3<sup>rd</sup>–4<sup>th</sup> c.

**2** Whorl with flat top and base and slightly curved side walls (Pl. 15: 5).

$d$ : 2,8 cm when reconstructed;  $h$ : 1,3 cm;  $d$  of the hole: 1.2 cm;  $m$ : 0.012 kg (unreconstructed)  
SU 368; □ M 27; A – VII; SF – 18

**3** The weight for a loom in the form of a truncated cone, made of sandy clay. Surface decorated with punctures (Pl. 19: 8).

$d_{base}$ : 8.8 cm;  $d_{top}$ : 4.5 cm;  $h$ : 9.2 cm;  $d$  of the hole: 1.2 cm;  $m$ : 0.6 kg  
SU 1363; □ (J 24/25); A – XVII; SF – 46; 1<sup>st</sup> quarter of the 5<sup>th</sup> c.

**4** The weight for a loom in the form of a truncated cone, made of sandy clay (Pl. 19: 9).

Dim. of the base: 4.6 x 4.2 cm;  $h$ : 9.5 cm,  $d$  of the hole: 9 mm;  $m$ : 0.332 kg  
SU 1363; □ (J 24/25); A – XVII; SF 47; 1<sup>st</sup> quarter of the 5<sup>th</sup> c.

### Catalogue of daub

**1** Fragment of daub. Smoothened on the front side; negatives of rectangular and rounded planks visible on the back side. (Pl. 6: 1).

Dim: 9.6 x 3.8 x 4 cm  
SU 425; □ V 28/29, W 29; A – VI; F – 327

**2** Fragment of daub. Fragment of a corner, smoothened on the front and on the back side, and brakes at an an-





## Katalog lijepa

- 1.** Ulomak lijepa. S vanjske strane je zaglađen, s unutrašnje se vide negativni pravokutnih i zaobljenih daski (T. 6: 1).  
Dim: 9,6 x 3,8 x 4 cm  
SJ 425; □ V 28/29, W 29; S – VI; N – 327
- 2.** Ulomak lijepa. Ulomak predstavlja kut, zaglađen je s vanjske i unutrašnje strane i lomi se pod kutom od 90% (T. 6: 2).  
Dim: 5,2 x 7,5 x 1,9 cm  
SJ 425; □ V 28/29, W 29; S – VI; N – 327
- 3.** Ulomak lijepa. S vanjske strane je zaglađen, s unutrašnje se vide negativni daski (T. 6: 3).  
Dim: 9,6 x 3,8 x 4 cm  
SJ 425; □ V 28/29 W 29; S – VI; N – 327
- 4.** Ulomak lijepa. U presjeku se uočavaju negativni pravokutnih i oblihi daščica. Vanjska strana je zaglađena (T. 6: 4).  
Dim: 8 x 10,5 x 7,5 cm  
SJ 425; □ V 28/29, W 29; S – VI; N – 287
- 5.** Ulomak lijepa s tragovima pravokutnih daski (T. 6: 5).  
Dim: 7,5 x 8,2 x 6,5 cm  
SJ 425; □ V 28/29, W 29; S – VI; N – 287
- 6.** Ulomak lijepa. U presjeku se vide tragovi negativna pravokutne daske. S vanjske strane površina je zaglađena i na njoj se nalazi pravokutno ispupčenje (T. 6: 6).  
Dim: 11 x 11 x 8,4 cm  
SJ 425; □ V 28/29, W 29; S – VI; N – 287
- 7.** Ulomak lijepa. Vanjska ploha je zaglađena (T. 7: 1).  
Dim: 14,5 x 17,2 x 7,4 cm  
SJ 425; □ V 28/29, W 29; S – VI; N – 287
- 8.** Ulomak lijepa. S jedne strane je zaglađen (T. 7: 2).  
Dim: 11,2 x 9,5 x 7 cm  
SJ 425; □ V 28/29, W 29; S – VI; N – 320
- 9.** Ulomak lijepa. S jedne strane je zaglađen, na suprotnoj strani očuvani su negativni dvije tanke grančice (T. 7: 3).  
Dim: 11 x 10,2 x 4 cm  
SJ 425; □ V 28/29, W 29; S – VI; N – 320
- 10.** Ulomak lijepa, dvije strane koje u presjeku tvore ugao su zaglađene (T. 7: 4).  
Dim: 10 x 14,4 x 7,4 cm  
SJ 425; □ V 28/29, W 29; S – VI; N – 320
- 11.** Ulomak lijepa. Jedna strana je zaglađena, u presjeku se uočavaju tragovi ravnih daski i šibe (T. 7: 5).  
Dim: 13 x 6 x 12,4 cm  
SJ 425; □ V 28/29, W 29; S – VI; N – 320
- 12.** Ulomak lijepa. Jedna strana je zaravnana, a s druge se  
gle of 90 % (Pl. 6: 2).  
Dim: 5.2 x 7.5 x 1.9 cm  
SU 425; □ V 28/29, W 29; A – VI; F – 327
- 3** Fragment of daub. Smoothened on the front side; negatives of planks visible on the back side (Pl. 6: 3).  
Dim: 9.6 x 3.8 x 4 cm  
SU425; □ V 28/29 W 29; A – VI; F – 327
- 4** Fragment of daub. Negatives of rectangular and rounded sticks visible in cross-section. Smoothened front side (Pl. 6: 4).  
Dim: 8 x 10.5 x 7.5 cm  
SU 425; □ V 28/29, W 29; A – VI; F – 287
- 5** Fragment of daub with traces of rectangular planks (Pl. 6: 5).  
Dim: 7.5 x 8.2 x 6.5 cm  
SU 425; □ V 28/29, W 29; A – VI; F – 287
- 6** Fragment of daub. Traces of the negative of a rectangular plank visible in cross-section. Smoothened front side with a rectangular bulge (Pl. 6: 6).  
Dim: 11 x 11 x 8.4 cm  
SU 425; □ V 28/29, W 29; A – VI; F – 287
- 7** Fragment of daub. Smoothened front side (Pl. 7: 1).  
Dim: 14.5 x 17.2 x 7.4 cm  
SU 425; □ V 28/29, W 29; A – VI; F – 287
- 8** Fragment of daub. Smoothened on one side (Pl. 7: 2).  
Dim: 11.2 x 9.5 x 7 cm  
SU 425; □ V 28/29, W 29; A – VI; F – 320
- 9** Fragment of daub. Smoothened on one side, negatives of two thin twigs preserved on the other (Pl. 7: 3).  
Dim: 11 x 10.2 x 4 cm  
SU 425; □ V 28/29, W 29; A – VI; F – 320
- 10** Fragment of daub; the two sides which make an angle in cross-section are smoothened (Pl. 7: 4).  
Dim: 10 x 14.4 x 7.4 cm  
SU 425; □ V 28/29, W 29; A – VI; F – 320
- 11** Fragment of daub. One side is smoothened; traces of flat planks and twigs visible in cross-section (Pl. 7: 5).  
Dim: 13 x 6 x 12.4 cm  
SU 425; □ V 28/29, W 29; A – VI; F – 320
- 12** Fragment of daub. One side is smoothened while there are negatives of twigs on the other (Pl. 9: 8).  
Dim: 5.7 x 6.4 x 3 cm  
SU 104; □ X 27; A – VI; F – 120
- 13** Fragment of daub. Smoothened on both sides, with



- nalaze negativni šibljica (T. 9: 8).  
Dim: 5,7 x 6,4 x 3 cm  
SJ 104; □ X 27; S – VI; N – 120
- 13.** Ulomak lijepa. Ulomak je zaglađen s obje strane s manjim nepravilnostima i otiscima dasaka (T. 9: 9).  
Dim: 6,2 x 6,5 x 1,6 cm  
SJ 104; □ X 27; S – VI; N – 120
- 14.** Ulomak lijepa. Jedna strana je zaglađena, na drugima je očuvan trag pravokutne daske i okrugle grane (T. 13: 1).  
Dim: 8,6 x 9 x 5,4 cm  
SJ 510; □ V 28; S – VI; N – 332
- 15.** Ulomak lijepa, jedna je strana zaglađena, na drugoj je očuvan otisak zaobljene grane (T. 13: 2).  
Dim: 6,2 x 9,5 x 5,4 cm  
SJ 510; □ V 28; S – VI; N – 332
- 16.** Ulomak lijepa, s jedne strane je ravan, s druge strane je ukošen s tragovima grana (T. 13: 3).  
Dim: 9,7 x 8,2 x 9 cm  
SJ 510; □ V 28; S – VI; N – 332
- 17.** Ulomak lijepa, s jedne strane je ravan s otiskom daske, s druge strane su očuvani negativni grana (T. 13: 4).  
Dim: 8,3 x 9,5 x 8,2 cm  
SJ 510; □ V 28; S – VI; N – 332
- 18.** Ulomak lijepa, s obe strane je ravan (T. 13: 5).  
Dim: 8,4 x 7,7 x 2,7 cm  
SJ 510; □ V 28; S – VI; N – 332
- 19.** Ulomak lijepa s otiscima prstiju i negativom grane (T. 21: 15a–15b).  
Dim: 11 x 2,5 x 1,7 cm  
SJ 1850/1851; □ (E/F 14); S – XX; N – 739
- 20.** Ulomak lijepa, s jedne strane je zaglađen, s druge strane su očuvani negativni grančica. Dio konstrukcije peći za kuhanje (T. 25: 3).  
Dim: 8 x 8,5 x 2,5 cm  
SJ 630; □ E/F 3; N – 411
- 21.** Ulomak lijepa, s jedne strane je zaglađen, s druge strane su očuvani negativni grančica. Dio konstrukcije peći za kuhanje (T. 25: 4).  
Dim: 4,7 x 6 x 2,6 cm  
SJ 630; □ E/F 3; S – XIV; N – 396
- 22.** Ulomak lijepa, s jedne strane je zaglađen, s druge strane su negativni daske i grančice. Dio konstrukcije peći za kuhanje (T. 25: 5).  
Dim: 6,2 x 9 x 2 cm  
SJ 630; □ E/F 3; S – XIV; N – 396
- smaller irregularities and imprints of boards (Pl. 9: 9).  
Dim: 6.2 x 6.5 x 1.6 cm  
SU 104; □ X 27; A – VI; F – 120
- 14** Fragment of daub. One side smoothed, traces of a rectangular board and of a rounded twig visible on other sides (Pl. 13: 1).  
Dim: 8.6 x 9 x 5.4 cm  
SU 510; □ V 28; A – VI; F – 332
- 15** Fragment of daub. One side smoothed, traces of a rounded twig visible on the other (Pl. 13: 2).  
Dim: 6.2 x 9.5 x 5.4 cm  
SU 510; □ V 28; A – VI; F – 332
- 16** Fragment of daub, smoothed on one side, with traces of twigs on the other (Pl. 13: 3).  
Dim: 9.7 x 8.2 x 9 cm  
SU 510; □ V 28; A – VI; F – 332
- 17** Fragment of daub; flat on one side with the imprint of a board, and with the negative of twigs preserved on the other side (Pl. 13: 4).  
Dim: 8.3 x 9.5 x 8.2 cm  
SU 510; □ V 28; A – VI; F – 332
- 18** Fragment of daub, flat on both sides (Pl. 13: 5).  
Dim: 8.4 x 7.7 x 2.7 cm  
SU 510; □ V 28; A – VI; F – 332
- 19** Fragment of daub with fingerprints and a negative of a twig (Pl. 21: 15a–15b).  
Dim: 11 x 2.5 x 1.7 cm  
SU 1850/1851; □ (E/F 14); A – XX; F – 739
- 20** Fragment of daub; smoothed on one side; negatives of twigs preserved on the other. Part of the construction of the cooking kiln (Pl. 25: 3).  
Dim: 8 x 8.5 x 2.5 cm  
SU 630; □ E/F 3; F – 411
- 21** Fragment of daub; smoothed on one side; negatives of twigs preserved on the other. Part of the construction of the cooking kiln (Pl. 25: 4).  
Dim: 4.7 x 6 x 2.6 cm  
SU 630; □ E/F 3; A – XIV; F – 396
- 22** Fragment of daub; smoothed on one side; negatives of twigs preserved on the other. Part of the construction of the cooking kiln (Pl. 25: 5).  
Dim: 6.2 x 9 x 2 cm  
SU 630; □ E/F 3; A – XIV; F – 396
- 23** Seven fragments of daub which could have formed a flat structure with a shallow groove along the edges.



**23.** Sedam ulomaka lijepa koji moguće tvore ravnu strukturu s plitkim žlijebom duž rubova. Dio konstrukcije peći za kuhanje (T. 25: 6a–6b).  
Dim: 0,90 x 0,90 x 0,54 m (u rekonstrukciji)  
SJ 630; □ E/F 3; S – XIV; N – 396

**24.** Ulomak lijepa koji tvori ugao, s dvije strane je zaglađen (T. 27: 10).  
Dim: 8,1 x 7,7 x 7,4 cm  
SJ 504; □ H/I 7/8, I 6; S – XII; N – 350

**25.** Ulomak lijepa. S jedne je strane zaglađen, s druge su očuvani negativi grana različite debljine (T. 27: 11).  
Dim: 12,4 x 11,5 x 8,6 cm  
SJ 504; □ H/I 7/8, I 6; S – XII; N – 350

**26.** Ulomak opeke s otiskom pseće šape (sl. 174).  
Dim: 9,4 x 7 x 2,7 cm  
SJ 368; □ M 27; S – VII; PN – 19

Part of the construction of the cooking kiln (Pl. 25: 6a–6b).  
Dim: 0.90 x 0.90 x 0.54 m (when reconstructed)  
SU 630; □ E/F 3; A – XIV; F – 396

**24** Fragment of daub forming an angle, smoothed on two sides (Pl. 27: 10).  
Dim: 8.1 x 7.7 x 7.4 cm  
SU 504; □ H/I 7/8, I 6; A – XII; F – 350

**25** Fragment of daub. Smoothed on one side; negatives of twigs of different thicknesses preserved on the other (Pl. 27: 11).  
Dim: 12.4 x 11.5 x 8.6 cm  
SU 504; □ H/I 7/8, I 6; A – XII; F – 350

**26** Fragment of a tegula with an imprint of a dog paw (fig. 174).  
Dim: 9.4 x 7 x 2.7 cm  
SU 368; □ M 27; A – VII; SF – 19



Sl. 173 Fotografija ulomka tegule s psećom šapom (ulomak)  
Fig. 173 Fragment of a tegula with an imprint of a dog paw

4.

Predmeti od stakla, metala, kamena i novac

*Glass, metal and stone items, and coins*





## Stakleno posuđe i katalog Glass vessels and the catalogue

Kristina Turkalj

Od ukupno 27 ulomaka stakla s lokaliteta Virovitica Kiškorija jug, samo 8 ulomaka moglo se donekle tipološki odrediti. Obradeni ulomci malih su dimenzija pa je tako analiza staklenog materijala bila otežana zbog nedostatka karakterističnih elemenata za određivanje tipova i varijantna posuda kao što su dimenzije cijele posude ili njezin cijeli profil.

Određeno je samo kojem dijelu posude pripadaju: četiri ruba posude, dva ulomka tijela posude, jedno dno i jedna ručka, ali se ne može sa sigurnošću reći kojem tipu posude pripadaju.

Rub ulomka s table T. 27: 4, (sl. 180) napravljen je tako da je staklo odrezano i rub kratko ponovno zagrijan da se zaobli. Staklo je tanko i dekolorirano.

Tako napravljen rub je čest i nalazimo ga na proizvodima od 1. do 4. st. Najrašireniji su od sredine 2. do sredine 4. stoljeća (Lazar 2003: 18). Ulomak s Kiškorije mogao bi, prema odrezanom i zataljenom rubu te promjeru posude, pripadati zdjeli forme 2.6.1 po Lazar, koji se datira od 3. do 4. stoljeća (Lazar 2003: 79, 82–83), kao i peharu koji Ružić datira u 2.-3. stoljeće (Ružić 1994: 43; T. XXX/8).

Ulomak na T. 27: 7, (sl. 179) dio je gornjeg dijela posude s rubom ravno izvučen i savijen prema unutra.

Stijenka te posude vrlo je tanka, boja stakla mliječnobijela. Zbog malog uzorka teško je odrediti tip posude i dataciju. Prema promjeru ulomak bi mogao pripadati čaši (Ružić 1994: T. XXX: 4, 6, 7; Lazar 2006: 5 4). Moguće da je riječ o čaši prstenasto zaobljenog ruba i cilindričnog recipijenta, koji se datira između 2. i 3. stoljeća (Ružić 1994: 43, T. XXX: 4, 6, 7; Barkóczy 1988: Taf. II: 16; Taf. VI: 60–62). Profilom je slična čašama rađenim iz modrozelenkastog stakla ili bezbojnog, namjerno dekoloriranog. Njihova stijenka je tanko puhana, dok su pri dekoloriranim proizvodima stijenke deblje. Cilindrične čaše služile su za piće i upotrebljavali su ih kao stolno posuđe. Njihova upotreba bila je od druge polovice 2. stoljeća do u 3. stoljeće (Lazar 2006: 70).

I rub ulomka na T. 26: 2, (sl. 178) izveden je na isti način, rub je izvučen i savijen prema unutra. Staklo je modrozelenkasto, a promjer je veći nego kod ulomka T. 27: 7, pa bi prema promjeru posuda mogla pripadati skupini zdjelica.

U drugoj polovici 1. stoljeća prevladavaju proizvodi

Out of 27 fragments of glass from the Virovitica Kiškorija south site, only 8 fragments could be typologically determined to a certain extent. Processed fragments are small in size so the analysis of glass material was difficult due to lack of characteristic elements used for determining the types and varieties of vessels, such as the dimensions of the entire vessel or its full profile.

It was possible only to determine to which part of the vessel four rims of a vessel, two fragments of a body of a vessel, one base and one handle belong; however it is not possible to say with certainty to which type of a vessel they belong.

The rim of the fragment from the Pl. 27: 4, (fig. 180) is designed in a way that the glass is cut and the edge reheated for a short period just to allow its curving. The glass is thin and decolourized.

Rims designed in this manner are common and can be found on products from the 1<sup>st</sup> to the 4<sup>th</sup> century. They were most common from the mid-2<sup>nd</sup> to the mid-4<sup>th</sup> century (Lazar 2003: 18). Fragment from Kiškorija could, according to its severed and annealed rim and its diameter, belong to a bowl of the 2.6.1 shape according to Lazar, which dates from the 3<sup>rd</sup> to the 4<sup>th</sup> century (Lazar 2003: 79, 82–83), or to a cup dated back by Ružić to the 2<sup>nd</sup> to the 3<sup>rd</sup> century (Ružić 1994: 43; T. XXX/8).

Fragment on Pl. 27: 7, (fig. 179) is part of the upper segment of a bowl with an upward protruding rim folded inward.

The wall of the vessel is very thin and the colour milky white. Because of the small size of the sample it is difficult to determine the type and the dating of the vessel. According to the diameter of the fragment, it may belong to a cup (Ružić 1994: T. XXX: 4, 6, 7; Lazar 2006: 4). It is possible that this is a cup with a rounded annular rim and a cylindrical recipient, which dates back to between the 2<sup>nd</sup> and the 3<sup>rd</sup> century (Ružić 1994: 43, T. XXX: 4, 6, 7; Barkóczy 1988: Taf. II: 16; Taf. VI: 60–62). Its cross-section is similar to that of cups made from the blue-green glass or of colourless, deliberately decolourized glass. Their walls are blown thin, while the decolourized products have thicker walls. Cylindrical cups were used for drinking and as tableware. They were used from the second half of the 2<sup>nd</sup> to the 3<sup>rd</sup> century (Lazar 2006: 70).

The rim of the fragment on Pl. 26: 2, (fig. 178) is moulded in the same manner - the rim is protruding outward and folded inward. Glass is blue-green, and the diameter is larger than the diameter of the fragment Pl. 27: 7; therefore



iz puhanog modro zelenog stakla. Rub je načinjen tako je izvučen i savijen uz stijenke posude (Lazar 2003: 235). Prirodno modro zeleno staklo uglavnom ima intenzivan plavi ili čak tirkizan ton tokom 1. stoljeća, koji u kasnijim stoljećima postaje tamno zelen (Rütti 1991: 340). Moguće da taj ulomka ruba pripada 1. stoljeću, ali se sa sigurnošću ne može reći zbog nedostatka elemenata za točnu rekonstrukciju posude.

Ulomak ruba, T. 18: 17, (sl. 177), od zelenkastog je stakla i prema izvedenom rubu mogao bi biti rub vrča ili boce. Rub posude savijen je prema van i onda prema unutra te zatim spljošten. Na taj način izrađen rub nalazimo na bocama i vrčevima u 1. i 2. stoljeću (Lazar 2003: 20), ali se mogu naći i na bocama koje se datiraju između 2. i 3. stoljeća (Transparentna ljepota 2013: kat. br 90; Gregl, Lazar 2008: 117–118; kat. br. 9–11).

Vrčevi su skupina posuđa s ručkom (ili dvije), koji imaju stajaću površinu zamjetno užu od najveće širine stijenke; posuda je kuglastog, kruškastog ili bikonusnog oblika. U pravilu imaju jednu ručku. Prvenstveno su bile namijenjene uporabi na stolu, pri posluživanju hrane, vode, vina (Gregl, Lazar 2008: 63). Boce su šira skupina posuđa za pohranu hrane, a mogu biti s ručkama ili bez njih (Lazar 2003: 26). Služile su za pohranu i transport hrane.

Vrčevi su rašireniji u prva dva stoljeća i koriste se do prve polovice 3. stoljeća, nakon čega njihova uporaba opada. Usporedba s bocama pokazuje da su oba oblika korištena usporedno do sredine 3. stoljeća nakon čega prevladavaju boce (Lazar 2003: 233–234).

Ulomak bi mogao pripadati raznim tipovima vrča (Barkóczy 1988: Taf. XXXV: 385; Taf. XXXVI: 395, 399),<sup>1</sup> kao i bocama (Barkóczy 1988: Taf. XXXIV: 369; Taf. XXXVII: 406; Taf. XXXVII: 419; Taf. XLIV: 455; Gregl, Lazar 2008: T. 9: 1–6).<sup>2</sup>

Ulomci posude T. 12: 9, (sl. 175), i T. 12: 10, (sl. 175) nađeni su zajedno, ne spajaju se, ali vjerojatno pripadaju istoj posudi. Boja i debljina stakla kod oba ulomka su isti, kao i brušeni ukrasi na stjenci posude. Staklo je prozirno, zelenkasto. Ukras čine pojasevi gustih i plitkih ureza.

Jednostavni horizontalni urezi i brušene trake bili su popularan i jednostavan način ukrašavanja posuda od 1. do 4. stoljeća. Nalaze se na posudama izrađenima iz obojenog, ali i dekoliriranog stakla, kao i na posudama iz modrozelenkastog stakla (Lazar 2003: 61).

Mogli bi pripadati kuglastoj čaši s horizontalnim urezima iz modrozelenkastog stakla koja se datira u drugu polovicu 1. stoljeća (Lazar 2004: 67, sl. 58). Ružić spominje kako se pojedine posude ukrašene geometrijskim motivima izvedenima brušenjem (ovalni, cik-cak linije) datiraju u 3. i 4. st., dok su primjerci zdjela i pehara ukrašeni samo urezanim horizontalnim, plićim ili dubljim urezima datirani

re, according to the diameter, this vessel may belong to a group of small bowls.

In the second half of the 1<sup>st</sup> century products made of blown blue-green glass prevail. Their rim is moulded in a way that it is drawn and bent alongside the wall of a vessel (Lazar 2003: 235). Natural blue-green glass usually has an intense blue or even turquoise colour during the 1<sup>st</sup> century, which in later centuries becomes dark green (Rütti 1991: 340). It is possible that this fragment of the rim belongs to the 1<sup>st</sup> century, but it cannot be said for certain because of the lack of elements for an accurate reconstruction of the vessel.

According to the way it was moulded, a fragment of the rim, Pl. 18: 17, (fig. 177), made of greenish glass, could be a rim of a jar or a bottle. It is protruding outward and then inward and then it is flattened. Rims moulded in this manner can be found on bottles and jars in the 1<sup>st</sup> and the 2<sup>nd</sup> century (Lazar 2003: 20), but also on bottles which have been dated between the 2<sup>nd</sup> and the 3<sup>rd</sup> century (Transparent Beauty 2013: Cat. No. 90; Gregl, Lazar: 2008: 117–118; Cat. No. 9–11).

Jars belong to a group of dishes with a handle (or two) with their standing surface noticeably narrower than the maximum width of the wall; they are spherical, pear-shaped or bi-conical. As a rule, they have a handle. They were primarily used as tableware, i.e. for serving food, water or wine (Gregl, Lazar 2008: 63). Bottles include a wider group of dishes used for food storage, and they come with or without handles (Lazar 2003: 26). They were used for storage and transport of food.

Jars were widespread during the first two centuries and continued to be used until the first half of the 3<sup>rd</sup> century; thereafter their use was in decline. Comparison with bottles indicates that both forms were used concurrently to the mid-3<sup>rd</sup> century, after which the bottles prevail (Lazar 2003: 233–234).

This fragment could belong to different types of jars (Barkóczy 1988: Taf. XXXV: 385; Taf. XXXVI: 395, 399),<sup>1</sup> or bottles (Barkóczy 1988: Taf. XXXIV: 369; Taf. XXXVII: 406, Taf. XXXVII: 419, Taf. XLIV: 455; Gregl, Lazar 2008: T. 9: 1–6).<sup>2</sup>

Fragments of a vessel Pl. 12: 9, (fig. 175), and Pl. 12: 10, (fig. 175) were found together, but cannot be joined together, although they probably belong to the same vessel. The colour and thickness of both fragments are identical, as well as ground decorations on the walls. Glass is transparent, greenish in colour. The decoration consists of wheel-cut bands.

Simple horizontal lines and wheel-cutting bands were a popular and easy way of decorating vessels from the 1<sup>st</sup> to the 4<sup>th</sup> century. They can be found on vessels made of both coloured and decolourized glass, as well as on the vessels made of blue-green glass (Lazar 2003: 61).

These fragments could belong to a type of a spherical

1 Barkóczy datira vrčeve ovisno o tipu od druge polovice 1. do 3. stoljeća (Barkóczy 1988: 165–170).

2 Boce su datirane, opet ovisno o tipu, od druge polovice 1. pa do u 4. stoljeće (Barkóczy 1988: 161–187; Gregl, Lazar 2008: 117–118).

1 Barkóczy dates jars according to type from the first half of the 1<sup>st</sup> until the 3<sup>rd</sup> century (Barkóczy 1988: 165–170).

2 Bottles are dated, again according to type, from the second half of the 1<sup>st</sup> to the 4<sup>th</sup> century (Barkóczy 1988: 161–187; Gregl, Lazar 2008: 117–118).



uglavnom u 4. st. (Ružić 1994: 10).

Ulomak na T. 15: 17, (sl. 176) dio je prstenaste noge. Noga je napravljena tako da je donji rub posude stisnut i izvučen iz posude na način da tvori zadebljan stajaći prsten. Zbog malog promjera stajaćeg prstena dno bi moglo pripadati čaši, ali pobliže analogije nisu moguće.<sup>3</sup>

Ručka vrča na T. 2: 3, (sl. 174) je iz modrozelenkastog stakla. Ulomak pripada gornjem završetku ručke koji je spojen s rubom posude. Ručka je formirana kod ruba u „S“ petlju koja je služila kao uporište za palac.

Ulomci zbog svojih malih dimenzija nisu upućivali na konkretnu rekonstrukciju već samo na moguće tipove prema promjeru (T. 12: 17; T. 26: 2; T. 27: 4, 7) ili prema načinu na koji je izveden rub (T. 18: 17). Nije očuvano dosta elemenata posude da bi se ulomci mogli opredijeliti u čaše odnosno zdjelice<sup>4</sup> tj. u vrč ili bocu,<sup>5</sup> što je otežalo analizu pojedinih ulomaka i onemogućilo detaljnije određivanje tipa pojedinih posuda, a tako i dataciju.

Pobliža datacije bila je moguća jedino kod dva ulomka stakla, T. 12: 9, 10, (sl. 175) zbog konteksta u kojemu su nađeni. Ulomci stijenke posude s brušenim ukrasom nađeni su zajedno s brončanom posudom (PN 22) koja se može datirati u drugu polovicu 4. stoljeća. Prema tome bi i ovi ulomci, vjerojatno čaše, pripadali tom periodu.

Može se reći da ulomci pripadaju slobodno puhanim proizvodima i možemo ih svrstati u stolno posuđe (čša, vrč, zdjelica) ili posuđe za pohranu (boca, zdjelica). Daljnja analiza svela bi se na nagađanje.

## KATALOG

### 1. Ulomak ručke. Staklo zelenkasto (T. 2: 3, sl. 174)

Dim: 1,4x1,6 cm

SJ 013; □ P 32/33; S-VI; PN-10



Sl. 174

Fig. 174

3 Slični ulomci prstenastog dna mogu se naći na tablama kod Košćević 2013: Pl. X, Lazar 2006: S17; Cool 1995: Fig. 4: 4; Foy 1995: Pl. 7: 38.

4 Kriteriji prema kojemu se međusobno razlikuju čaša i zdjelica su odnos promjera ruba i visine posude.

5 Vrč je tip posude u kojem je dno izrazito uže od najšireg oboda stijenke, a boce su šira skupina posuda za čuvanje ili posluživanje hrane.

cup with horizontal cuts made of blue-green glass, which dates back to the second half of the 1<sup>st</sup> century (Lazar 2004: 67, fig. 58). Ružić mentions that certain vessels decorated with geometric motifs executed by grounding (ovals, zig-zag lines) date back to the 3<sup>rd</sup> and the 4<sup>th</sup> century, while the samples of bowls and jars are decorated only with incised horizontal, shallower or deeper cuts dated mainly to the 4<sup>th</sup> century (Ružić 1994: 10).

Fragment on Pl. 15: 17, (fig. 176) is a part of an annular leg. The leg is made so that the bottom edge of the vessel is compressed and pulled out of the vessel in order to form a thickened standing ring. Due to a small diameter of a standing ring, this base could be associated with a cup; however, closer analogies are not possible.<sup>3</sup>

Handle of a jar on Pl. 2: 3, (fig. 174) is made of blue-green glass. It is a fragment of the upper end of the handle which is attached to the rim of the vessel. At the vessel's rim the handle is formed in the S-loop which served as a support for the thumb.

Due to their small size, the fragments did not point to specific reconstruction but only to possible types as to their diameter (Pl. 12: 17; Pl. 26: 2; Pl. 27: 4, 7) or the way in which the rim was moulded (Pl. 18: 17). Due to insufficient number of elements of the vessel preserved, the fragments could not have been identified neither as cups nor as bowls<sup>4</sup> or as jars or bottles,<sup>5</sup> which made it difficult to analyze individual fragments. Also, this made a more detailed determination of a type of individual vessels and dating impossible as well.

More precise dating was possible only for two fragments of glass, Pl. 12: 9–10 (fig. 175) thanks to the context in which they were found. Fragments of the wall of the vessel with brushed decoration were found together with a bronze vessel (SF 22), which can be dated to the second half of the 4<sup>th</sup> century. According to that, these fragments - probably parts of a cup - could belong to that particular period.

It could be said that all of the fragments belong to the free-blown products, and we can classify them as tableware (cup, jar, bowl) or as storage vessels (bottle, bowl). Further analysis would be reduced to guesswork.

## CATALOGUE

### 1 Fragment of a handle. Greenish glass (Pl. 2: 3, fig. 174)

Dim: 1.4 x 1.6 cm

SU 013; □ P 32/33; A-VI; SF-10

### 2 Fragment of the body of a vessel. Greenish transparent

3 Similar fragments of an annular base can be found on tables in Košćević 2013: Pl. X, Lazar 2006: S17; Cool 1995: Fig. 4: 4; Foy 1995: Pl. 7: 38.

4 Criteria for differentiation of cups from bowls is ratio between the diameter of the rim and the height of the vessel.

5 The jug is a type of a vessel whose base is distinctly narrower than the widest circumference of the wall, and the bottles are a wider group of vessel for storing or serving food.





- 2.** Ulomak tijela posude. Staklo zelenkasto, prozirno. Stijenka je ukrašena s jednim pojansom gustih i plitkih ureza (T. 12: 9, sl. 175).  
Dim: 3,1 x 2,1 cm, WT: 0,3 cm.  
SJ 404; □ K/L 29/30; S-VII; N-272

- 3.** Ulomak tijela posude. Staklo zelenkasto, prozirno. Stijenka je ukrašena s tri pojasa gustih i plitkih ureza (T. 12: 10, sl. 175).  
Dim: 3,6 x 3,1 cm, WT: 0,3 cm.  
SJ 404; □ K/L 29/30; S-VII; N-272



240

Sl. 175  
Fig. 175

- 4.** Ulomak dna posude. Noga sa zadebljanim izvučenim stajaćim prstenom. Staklo dekolorirano, s mjehurićima (T. 15: 17, sl. 176).  
Dim: 3,3 x 1,4 cm, WT: 0,5 cm, dB: 4,5 cm.  
SJ 636; □ E 3; S-XIV; N-1770
- 5.** Ulomak ruba. Rub savijen prema van i onda prema unutra, spljošten. Staklo zelenkasto, prozirno, vidljivi su mjehurići u staklu (T. 18: 17, sl. 177).  
Dim: 4 x 1,5cm; WT: 0,4 cm; dR: 4 cm.  
SJ 1141; □ (K 29); S-XV; N-549
- 6.** Ulomak ruba posude. Rub je ravno izvučen i savijen prema unutra. Staklo modrozelenkasto, prozirno (T. 26: 2, sl. 178).  
Dim: 3,6 x 1 cm; WT: 0,2 cm; dR: 10,5 cm.  
SJ 001; S-III/IV; N-9



Sl. 178  
Fig. 178

- glass. The decoration on the wall are wheel-cut bands (Pl. 12: 9, fig. 175).  
Dim: 3.1 x 2.1 cm; WT: 0.3 cm.  
SU 404; □ K/L 29/30; A-VII; F-272

- 3** Fragment of the body of a vessel. Greenish transparent glass. The wall decorated by three wheel-cut bands (Pl. 12: 10, fig. 175).  
Dim: 3.6 x 3.1 cm, WT: 0.3 cm.  
SU 404; □ K/L 29/30; A-VII; F-272

- 4** Fragment of the base of a vessel. A leg with a thickened tubular base ring. Decolourized glass, with some bubbles (Pl. 15: 17, fig. 176).  
Dim: 3.3x1.4 cm, WT: 0.5 cm, dB: 4.5 cm.  
SU 636; □ E 3; A-XIV; F-1770

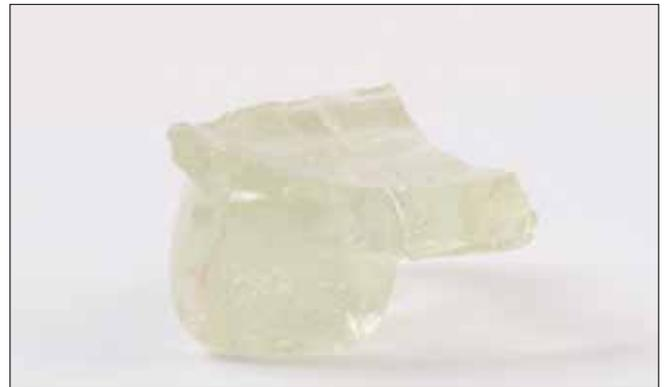

Sl. 176  
Fig. 176

- 5** Fragment of a rim. The rim everted, bent and flattened. Blue-green transparent glass with visible bubbles (Pl. 18: 17, fig. 177).  
Dim: 4 x 1.5cm; WT: 0.4 cm; dR: 4 cm.  
SU 1141; □ (K 29); A-XV; F-549



Sl. 177  
Fig. 177

- 6** Fragment of the rim of a vessel. The rim is curved inward and pressed against the inside wall. Blue-green transparent glass (Pl. 26: 2, fig. 178).



- 7.** Ulomak ruba. Rub je ravno odrezan i zataljen. Staklo dekolirano, vidljivi su mjehurići u staklu (T. 27: 4, sl. 179).

Dim: 2,2 x 2,5cm, WT: 0,2 m; dR 11 cm.

SJ 424; □ U/V 25; S-VII; N-281



Sl. 179

Fig. 179

- 8.** Ulomak ruba čaše. Rub je ravno izvučen i savijen prema unutra. Staklo mliječno bijelo (T. 27: 7, sl. 180).

Dim: 4,8 x 1,6 cm, WT: 0,1 cm; dR: 7,7 cm.

SJ 504; □ H/I 7/8; S-XII/XIII; PN-33

Dim: 3.6x1 cm; WT: 0.2 cm; dR: 10.5 cm.

SU 001; A III/IV; F 9

- 7** Fragment of a rim. The rim is cut straight and annealed. Decolourized glass with visible bubbles (Pl. 27: 4, fig. 179).

Dim: 2.2 x 2.5cm; WT: 0.2 m; dR 11 cm.

SU 424; □ U/V 25; A-VII; F-281

- 8** Fragment of the rim of a cup. The rim is curved inward and pressed against the inside wall. Milky white glass (Pl. 27: 7, fig. 180).

Dim: 4.8 x 1.6 cm, WT: 0.1 cm; dR: 7.7 cm.

SU 504; □ H/I 7/8; A-XII/XIII; SF-33



Sl. 180

Fig. 180



## 4.2.

### Nakit od stakla i katalog *Glass jewellery and the catalogue*



243

Sl. 181 Perle i narukvice od stakla  
*Fig. 181 Glass beads and glass bracelets*

#### **Perle**

U manjem ukopu, SJ 052/053, u kompleksu 1, pronađeni su zanimljivi stakleni predmeti. Riječ je o perlama od tamnog stakla. Takve su perle izrađene namotavanjem stakla oko štapića. Nakon zagrijavanja stakla površina bi se zagladila, u potpunosti ili djelomično (Spaer 2001: 44-45). Djelomično zaglađena površina ostavljala bi plitke pravilne ureze što je samo po sebi činilo ukras. Dio perli iz ovog ukopa nije uopće zaglađen ili je polomljen radi čega se može interpretirati kao poluproizvod ili otpad. Primjerci koji su zaglađeni nisu pravilno izvedeni i dovršeni što također govori o mogućem otpadu. Na prvi pogled perle su crne, a kada ih se promatra u njihovom najtanjem, rubnom dijelu tamno zelene su boje. Takve su perle, kada predstavljaju gotov proizvod, mogle biti duguljaste sa širim dijelom u sredini, ili kraće valjkaste te ukrašene dodatno drugim tehnikama (Spaer 2001: 48-55).

Neuspjeli pokušaji izrade ovih perli govore o

#### **Beads**

In a small cut, SU 052/053, complex 1, interesting glass artefacts were found, i.e. dark glass beads. Such beads are made by winding glass around the stick. After heating, the glass surface was fully or partly smoothed down (Spaer 2001: 44-45). Shallow regular notches on the partly smoothed down surface seemed like a decoration itself. Some of the beads from this cut are not smoothed down at all or are broken, due to which they can be interpreted as intermediate goods or as a waste. The samples which are smoothed down are not properly crafted and completed, which also indicates potential waste. At first glance, the beads are black in colour, however when they are viewed at their thinnest point, their edge is dark green in colour. Such beads, if considered to be a finished product, were elongated in shape and widest in their middle part, or smaller and cylindrical in shape and decorated by other techniques (Spaer 2001: 48-55).

Failed attempts of making these beads indicate a possibility of the production of such jewellery on this site during the 3<sup>rd</sup> to the 4<sup>th</sup> century, but in order to confirm the

mogućnosti izrade takvog nakita na lokalitetu u 3.–4. st., ali za sigurnu proizvodnju nedostaju dodatni elementi.

Pored crnih, pronađene su i dvije manje crvene perle koje su najčešće proizvedene razvlačenjem (Spaer 2001: 46–47).

### Narukvice

Staklene narukvice predstavljaju čest i dobro zastupljen nakit u Panoniji, a na to upućuju neke objave (Zbirka Pavletić: 91–92; Bačani et al. 2012: 17–180), a još više pogled u depoe muzeja tog područja nego stanje objavljenosti. Na lokalitetu Virovitica Kiškorija jug pronađeno sedam ulomaka narukvica od stakla koji su već bili predmet znanstvene i detaljne objave te se ovdje samo navode najvažniji podaci kako bi na jednom mjestu okupili sve nalaze s lokaliteta. Prethodno je pogrešno napisano od kakvog je materijala izrađen ovaj nakit (Jelinčić 2006b: 65; 2007b: 213–220), riječ je o staklu, ne o pasti ili gagatu. To je potrebno naglasiti jer je gagat bio skupocjeniji, a pridavala mu se i magična moć. Također, on se povezivao sa zagrobnim životom pa je često bio prilagan u grobovima, a narukvice od stakla, o kakvima je ovdje riječ, bile su zamjena skupocjenim narukvicama od gagata (Koščević 1996: 82) i kao takve imale su podjednaka magična svojstva. Iako skromna i jeftina zamjena za gagat, stanovnici ovog sela ipak su pratili trendove te su, barem u obliku imitacije, posjedovali nakit kakav se u tom razdoblju nosio u Europi i na Istoku. To govori o važnosti obližnjih prometnica koje su čak i u ovako male sredine nosile novitete. Na primjeru tih narukvica vidimo, da vremenski ne zaostaju za narukvicama iz drugih dijelova Europe i Bliskog istoka. Ako je ovo naselje pratilo modne trendove i u istom trenutku su žene i djeca nosile nakit kakav se nosio u urbaniziranim velikim središtima, može se pretpostaviti da je i u svim ostalim segmentima života u korak pratilo razvoj, tehnologiju i kretanja u Rimskom Carstvu zahvaljujući postojanju važne prometnice u neposrednoj blizini. Manji dio narukvica ove vrste susreće se u naseljima, a vjerojatno je to samo odraz pažnje koja se pridavala ovoj vrsti nalaza pri obradi naselja. Moguće je i to da rimska naselja nisu u tolikoj mjeri istražena i objavljena kao groblja, pa se na temelju toga pogrešno može zaključiti kako su ove narukvice češći nalaz u grobljima nego u naseljima.

Neke od narukvica su malih dimenzija i nisu ih mogli nositi odrasli, a čini se da su one općenito u početku bile izrađivane samo za djecu (Buljević 1999: 190), dok ih kasnije nose i odrasli. Zbog toga je mjeren njihov promjer i podijeljene su na male i velike. Ovdje su zastupljene 4 velike narukvice (kat. br. 3, 6, 8, 9) i 3 male (kat. br. 4, 5, 7). Među primjercima s ovog lokaliteta prisutna su četiri tipa narukvica: A 2 a (narukvice kat. br. 3, 6, 7), B 2 a/b (kat. br. 4 i 9), B 3 a (kat. br. 5) i B 5 a (kat. br. 8). Osim ovoga posljednjeg, spomenuti tipovi čine najbrojnije i najzastupljenije narukvice ove vrste u kasnoj antici (Buljević 1999: 194).

Narukvice tipa A 2 a su neukrašene, glatke, jednobojne

production we need to have some additional elements.

In addition to the black ones, two small red beads, probably produced by stretching, were found (Spaer 2001: 46–47).

### Bracelets

Glass bracelets are common and well represented jewellery in Pannonia, which is indicated in some publications (Zbirka Pavletić: 91–92; Bačani et al. 2012: 17–180), and even more so by looking into depots of some of the museums in the subject area, rather than by the state of the published data. At the Virovitica Kiškorija south site, seven fragments of glass bracelets were found, and have already been the subject of detailed scientific publication. Therefore, only the most important information is mentioned here in order to gather all the findings from the site in one place. Previously, it was incorrectly stated that this jewellery was made of paste or jet (Jelinčić 2006b: 65; 2007b: 213–220), whereas in fact it was made of glass. It is necessary to emphasize this because the jet was expensive and thought to have magical powers. Likewise, it was associated with the afterlife and was often deposited in graves, while the glass bracelets, the kind we have here, were a substitute for precious bracelets made of jet (Koščević 1996: 82) and as such had similar magical characteristics. Although glass bracelets were modest and inexpensive replacement for jet ones, the residents of this village still followed the trends and, though in the form of an imitation, possessed the jewellery like the one worn in Europe and in the East at the time. This speaks of the importance of the nearby routes by which the latest novelties were brought even to as small communities as this one. On the example of these bracelets we can see that they are not far behind the bracelets from other parts of Europe and the Middle East.

If this settlement followed fashion trends, and women and children wore jewellery of the same type as was worn in large urban centres at the time, it can be assumed that in all other aspects of life they also kept up with development, technology and movements in the Roman Empire owing to the existence of important routes in the immediate vicinity. Fewer bracelets of this type were found in settlements, this probably being just a consequence of the attention given to this type of finds in the analysis of settlements. Also, it is possible that Roman settlements are not as researched and published as cemeteries, and that it can be erroneously assumed that these bracelets are more frequently found in cemeteries than in settlements.

Some of the bracelets are small in size and could not be worn by adults, so it would seem that initially they were in general made for children only (Buljević 1999: 190), whereas later on they were worn by the adults as well. Therefore, their diameter was measured and they are divided into small and large ones. Here we bring 4 large bracelets (Cat. No. 3, 6, 8, 9) and 3 small ones (Cat. No. 4, 5, 7). Among the pieces from this site we have four types of bracelets: A 2 a (bracelets Cat. No. 3, 6, 7), B 2 a / b (Cat. No. 4 and 9), B 3 a (Cat. No. 5) and B 5 a (Cat. No. 8). Except for the last one, the types mentioned herein make up the most numerous and widespread types of bracelets in Late Antiquity (Buljević 1999: 194).

narukvice, polukružnog presjeka koje se datiraju od 3. do 7. st. Ova je varijanta vrlo raširena (Spaer 1988: 54; Buljević 1999: 193). U kontekstu tog naselja, one se mogu datirati od 3. do početka 5. st., kada se odvija život u selu (Jelinčić 2006b: 66), što se tiče narukvice kat. br. 7 koja je pronađena u oranom sloju. Narukvica kat. br. 3 iz jame SJ 427/428 datira se, prema drugim nalazima iz cjeline, od 3. do 4. st., a narukvica iz bunara SJ 802 (kat. br. 6) datira se u prvu polovicu 3. st., prema rezultatima analize ugljena iz tog objekta. U Europi su prisutne mnogobrojne analogije za tip A 2 a, bez obzira na materijal od kojeg su izrađene (staklo, gagat) datirane uglavnom u 3. i 4. st (Jelinčić 2007b: 216–217).

Drugi tip koji je zastupljen je tip B 2, podtip a/b. Narukvice tipa B 2 s vodoravnim rebrenjem imaju okomito neuredno (B 2 a) i uredno te često malo zavijeno rebrenje (B 2 b) (Spaer 1988: 55; Buljević 1999: 193). U ovom slučaju teško je odrediti radi li se o podtipu a ili b, pa je određen kao B 2 a/b, budući da je rebrenje izvedeno okomito i uredno. Pronađena su dva ulomka (kat. br. 4, 9), jedan u oranom sloju (kat. br. 9), drugi (kat. br. 4) u jami SJ 238/239. Podtipovi a i b su najzastupljeniji od B tipova i datiraju se 3.–4. st. na Istoku (Spaer 1988: 56–57), u Europi, ali i na ovom lokalitetu (Jelinčić 2007b: 217).

Treći tip je B 3, podtip a, koji je ukrašen dijagonalnim rebrenjem gdje su rebra ispupčena, ali ne jako kao kod B 3 b tipa. Inače, datiraju se od 3.–4. st., a na lokalitetu je ovaj tip zastupljen jednim primjerkom (kat. br. 5) koji je pronađen u bunaru SJ 802 datiranom u prvu polovicu 3. st. Ovaj tip također nalazi brojne analogije na ovom prostoru (Jelinčić 2007b: 217).

Četvrti tip narukvice zastupljen je jednim primjerkom (kat. br. 8) i pronađen je u oranom sloju. Radi se od tipu B 5 podtipu a, koji ima jedan niz ovalnih ispupčenja. Datira se u 3.–4. st., a nije neuobičajen na našim prostorima (Jelinčić 2007b: 217).

Na lokalitetu Virovitica Kiškorija jug nema lokalnih i europskih tipova narukvica, a oni tipovi koji su zastupljeni (posebice A 2 a, B 2 a/b i B 3 a) javljaju se u velikom broju na svim područjima gdje su se ovakve narukvice nosile. Narukvice s ovog lokaliteta vremenski pripadaju istom razdoblju kao i narukvice tih tipova na drugim lokalitetima, odnosno one ne pokazuju nikakvo vremensko odstupanje od datuma postavljenih u tipologiji Maud Spaer i datuma s drugih lokaliteta gdje su te narukvice mogle biti datirane.

Prisutnost ovakve vrste nakita u seoskoj sredini govori o njegovoj širokoj upotrebi i modnoj zastupljenosti, a skromni materijal od kojeg su izrađene ukazuje na stupanj bogatstva u naselju. Praćenje trendova u nošenju narukvica sigurno se odražavalo i u svim ostalim dijelovima svakodnevnice života u ovom selu, što će vjerojatno biti potvrđeno analizama drugog materijala pronađenog na ovom lokalitetu.

Type A 2 bracelets are not decorated, they are smooth, monochrome, of semi-circular cross-section, dated to the 3<sup>rd</sup> until the 7<sup>th</sup> century. This variety is rather widespread (Spaer 1988: 54; Buljević 1999: 193). In the context of this settlement, they can be dated from the 3<sup>rd</sup> to the early 5<sup>th</sup> century, i.e. to the period of life in the village (Jelinčić 2006b: 66), as far as the bracelet Cat. No. 7, which was found in the ploughed layer, is concerned. Cat. No. 3 bracelet, found in the pit SU 427/428, is dated, as compared to other findings from that structure, from the 3<sup>rd</sup> to the 4<sup>th</sup> century, while a bracelet from the well, SU 802 (Cat. No. 6), is dated to the first half of the 3<sup>rd</sup> century according to the results of the coal analysis from that facility. Numerous analogies for type A 2 can be found in Europe, regardless of the material they are made of (glass, jet) and are dated mostly in the 3<sup>rd</sup> and the 4<sup>th</sup> century (Jelinčić 2007b: 216–217).

The B 2 type, subtype a/b, bracelet is the second type represented. Bracelets of a B 2 type, with horizontal ribbing, have both disorganized (B 2 a) and organized, and often slightly curved vertical ribbing (B 2 b) (Spaer 1988: 55; Buljević 1999: 193). In this case it is difficult to determine whether the bracelets are of the subtype a or of the subtype b, therefore they are designated as B 2 a/b, since the ribbing is vertical and organized. Two fragments were found (Cat. No. 4, 9): one in the ploughed layer (Cat. No. 9), and another (Cat. No. 4) in the pit SU 238/239. Subtypes a and b are the most common of the B type bracelets and they can be dated from the 3<sup>rd</sup> to the 4<sup>th</sup> century in the East (Spaer 1988: 56–57), in Europe, and on this site, as well (Jelinčić 2007b: 217).

The third type is B 3, subtype a, which is decorated with a diagonal ribbing with convex ribs, but not as protruding as in B 3 b type. Normally, they are dated in 3<sup>rd</sup>–4<sup>th</sup> century. At this site, this type is represented by one sample (Cat. No. 5), which is found in the well SU 802 and dated to the first half of the 3<sup>rd</sup> century. This type also has numerous analogies in this area (Jelinčić 2007b: 217).

The fourth type of bracelets is represented by one sample (Cat. No. 8), found in the ploughed layer. The bracelet in question is the type B 5, subtype a, which has one row of oval bulges. It dates back in 3<sup>rd</sup>–4<sup>th</sup> century, and is not uncommon in our region (Jelinčić 2007b: 217).

At the Virovitica Kiškorija south site there are no local and European bracelet types, and those types that are represented (especially A 2 a, B 2 a/b and B 3 a) appear in large numbers in all areas where such bracelets were worn. Bracelets from this site date back to the same period as the bracelets of the same types from other sites, and they do not show any time divergence from the dates set out in the Maud Spaer's typology and the dates from other sites where bracelets of this type could have been dated.

The presence of this type of jewellery in the rural environment is indicative of their widespread use and their share in the fashion of the day, while the low-cost material the jewellery was made of indicates the level of prosperity of the village. The trend of wearing the bracelets was certainly also followed by other parts of everyday life in this village, which is likely to be confirmed by the analyses of other artefacts found at this site.

## KATALOG

1. Perle od tamno zelenog stakla. Boja se uočava tek kada se gleda prema jakom izvoru svjetlosti. Izrađene su od tanke staklene žice namotane oko štapića, a potom glađane. 3.–4. st. (T. 2: 14).  
*d* – rupe: 1 mm, WT: 1 mm.  
SJ 052; □ P 31; S–VI; PN–7
2. Dvije perle od crvenog neprozirnog stakla. 3.–4. st. (T. 2: 14).  
*d* – rupe: 1 mm; WT: 1 mm.  
SJ 052; □ P 31; S–VI; PN–7
3. Ulomak neukrašene staklene narukvice crne boje koja se prozire: prema jakom svjetlu vidi se kao zelena. Površina je vrlo sjajna, neukrašena, polukružni; tip: A 2 a; od 3. do početka 7. stoljeća. (T. 8: 14).  
*d* – 5,9 cm; velika; debljina: 9 mm; širina: 5–6 mm; presjek: polukružni  
SJ 427; □ U 27, S–VI; PN–37
4. Ulomak ukrašene staklene narukvice, crne boje, neprozirna je. Površina je sjajna, ukrašena okomitim rebrenjem; tip: B 2 a; od 3.–4. stoljeća (T. 12: 8).  
debljina: 9 mm; širina: 5,5 mm; presjek: polukružni  
SJ 238; □ L/M 28, S–VII; PN–14
5. Ulomak ukrašene staklene narukvice. Crne boje, ali prema jakom svjetlu vidi se kao zelena; visina je neujednačena, ukrašena je dijagonalnim rebrastim ispupčenjima; tip: B 3 a; od 3.–4. stoljeća, pronađena je u kontekstu početka 3. st. (T. 17: 18).  
*d* – 4,6 cm; mala; debljina: 5–9 mm; širina: 4 mm  
SJ 802; □ D 3; S–XIV; PN–42
6. Ulomak neukrašene narukvice od neprozirnog stakla. Prema jakom svjetlu vidi da je plave boje; tip: A 2 a; od 3. do početka 7. stoljeća, kontekst: početak 3. st. (T. 17: 19).  
debljina: 9 mm; širina: 5,5 mm; presjek: polukružni  
SJ 802; □ (M 33); S–XIV; PN–40
7. Ulomak neukrašene narukvice. Crne je boje, neprozirna je. Površina je sjajna i neukrašena. tip: A 2 a; od 3. do početka 7. stoljeća (T. 26: 3).  
*d* – 4,9 cm; mala; debljina: 5 mm; širina: 4 mm; presjek: polukružni  
SJ 001; □ Q 27; S–VI; PN–13
8. Ulomak ukrašene staklene narukvice, crne boje, ne propušta svjetlo. Površina je sjajna, ukrašena jednim redom ovalnih utisnutih ispupčenja; tip: B 5 a; od 3.–4. stoljeća (T. 26: 4).  
*d* – 6 cm; debljina: 10 mm; širina: 5 mm; presjek: polukružni  
SJ 001; □ ? S–VII; PN–31
9. Ulomak ukrašene staklene narukvice. Čini se kao da je od crnog stakla, ali se prema jakom svjetlu vidi kao zelena; Ukraša se sastoji od okomitih rebrastih ispupčenja; B 2 a/b; od 3.–4. stoljeća (T. 26: 5).  
*d* – 5,9 cm; debljina: 1 cm; širina: 5 mm  
SJ 001; □ ?; S–XIV; PN–36

## CATALOGUE

- 1 Dark-green glass beads. The color can be observed only when seen against a strong source of light. They are made of thin glass wire wound around the stick and then smoothed down. 3<sup>rd</sup>–4<sup>th</sup> century (Pl. 2: 14).  
*d* – of the hole: 1 mm, WT: 1 mm.  
SU 052; □ P 31; A–VI; SF–7
- 2 Two beads made of opaque red glass. 3<sup>rd</sup>–4<sup>th</sup> century (Pl. 2: 14).  
*d* – of the hole: 1 mm; WT: 1 mm.  
SU 052; □ P 31; A–VI; SF–7
- 3 Fragment of an undecorated transparent black glass bracelet: green when seen against strong source of light. The surface is very glossy, undecorated. Semicircular; type A 2 s; from the 3<sup>rd</sup> until the early 7<sup>th</sup> century (Pl. 8: 14).  
*d* – 5.9 cm; large; thickness: 9 mm; width: 5–6 mm; cross-section: semi-circular  
SU 427; □ U 27, A–VI; SF–37
- 4 Fragment of a decorated opaque black glass bracelet. The surface is glossy, decorated with vertical ribs; type B 2 a; from the 3<sup>rd</sup> until the 4<sup>th</sup> century (Pl. 12: 8).  
thickness: 9 mm; width: 5.5 mm; cross-section: semi-circular  
SU 238; □ L/M 28, A–VII; SF–14
- 5 Fragment of a decorated glass bracelets. Black, however, green when seen against a strong light; height is uneven, decorated with a diagonal ribbed bulges; type B 3 a; from the 3<sup>rd</sup> until the 4<sup>th</sup> century, found in the context of the early 3<sup>rd</sup> century (Pl. 17: 18).  
*d* – 4.6 cm; small; thickness: 5–9 mm; width: 4 mm  
SU 802; □ D 3; A–XIV; SF–42
- 6 Fragment of an undecorated opaque glass bracelet. Blue when seen against a strong light, type A 2 a; from the 3<sup>rd</sup> until the early 7<sup>th</sup> century, context: early 3<sup>rd</sup> century (Pl. 17: 19).  
thickness: 9 mm; width: 5.5 mm; cross-section: semi-circular  
SU 802; □ (M 33); A–XIV; SF–40
- 7 Fragment of an undecorated opaque black bracelet. Glossy, undecorated surface, type A 2 a; from the 3<sup>rd</sup> until the early 7<sup>th</sup> century (Pl. 26: 3).  
*d* – 4.9 cm; small; thickness: 5 mm; width: 4 mm; cross-section: semi-circular  
SU 001; □ Q 27; A–VI; SF–13
- 8 Fragment of a decorated opaque black glass bracelet. The surface is glossy, decorated with a row of oval impressed bulges; type B 5 a; from the 3<sup>rd</sup> until the 4<sup>th</sup> century (Pl. 26: 4).  
*d* – 6 cm; thickness: 10 mm; width: 5 mm; cross-section: semi-circular  
SU 001; □ ? A–VII; SF–31
- 9 Fragment of a decorated glass bracelets. Seemingly made of black glass, however, it appears to be green when seen against a strong light. The decoration consists of vertical ribbed bulges; type B 2 a/b; from the 3<sup>rd</sup> until the 4<sup>th</sup> century (Pl. 26: 5).  
*d* – 5.9 cm; thickness: 1 cm; width: 5 mm  
SU 001; □ ?; A–XIV; SF–36

## 4.3.

# Metalni predmeti. Alati, oruđe, posuđe i ukrasni predmeti, katalog Metal items. Tools, implements, vessels and decorative items, catalogue

Ivan Radman-Livaja  
Karmen Farac

Metalni predmeti pronađeni na lokalitetu Kiškorija se brojnošću i raznovrsnošću svakako ne mogu mjeriti s keramičkim nalazima, no tome se ionako ne treba čuditi. Metalni predmeti su u načelu skuplji i dragocjeniji od većine keramičkih proizvoda, te se na njih više pazi i ne odbacuje ih se olako, a kako su, razumljivo, daleko manje lomljivi od keramike ili stakla, rjeđe će ih se naći među otpadnim materijalom koji ionako preteže među arheološkim nalazima u naseljima i stambenim strukturama.

Iako relativno malobrojni, metalni artefakti iz Kiškorije jasno pokazuju kakva se vrsta kovinskih predmeta rabila i posjedovala u tom rimskom ruralnom naselju. U biti je mahom riječ o uporabnim predmetima namijenjenima svakodnevnom radu u poljoprivredi, obrtničkim djelatnostima i kućanskim poslovima, uz pokoji dio nošnje. Osim nedvojbeno poljoprivrednih alatki, nalazimo noževe o čijoj širokoj svakodnevnoj uporabi ne treba posebno raspravljati, dijelove brončanih posuda koje su zasigurno korištene u kuhinji i pripremi jela, kao i raznorazni alat za nezaobilazne i nužne poslove u životnoj svakodnevici svakog ruralnog naselja, poput igala te kožarskog i tesarskog pribora. Dijelova nošnje nema mnogo, no fibule i prstenje svakako ne predstavljaju začuđujuće nalaze u naselju čije se postojanje može mjeriti stoljećima.

Neki nalazi vjerojatno ukazuju i na kovačku, odnosno metaluršku djelatnost, što je opet sasvim razumljivo za ovakav tip lokaliteta.

Iako se neki od ovih predmeta i tipološki mogu lako diferencirati te smjestiti u relativno precizan vremenski okvir, činjenica je da su mnogi, posebice alati, u uglavnom nepromijenjenom obliku korišteni kroz cijelo antičko razdoblje. Da je kojim slučajem riječ o slučajnim nalazima, teško da bi ih mogli datirati u neko uže razdoblje. Srećom, u ovom slučaju kontekst nalaza i radiometrijske analize omogućavaju dosta preciznu dataciju većine predmeta.

## KATALOG METALNIH NALAZA

1. Češljagija (T. 5: 10a–10b, sl. 182–183)  
Možemo pretpostaviti da je riječ o alatki koju su Rimljani općenito zvali *scalprum*, odnosno preciznije *scalpto-*

The number of metal items found on the *Kiškorija* site cannot be compared with the number of ceramic finds, though it is not something that should surprise us. They are generally more expensive and more precious than most of the ceramic products, so that they are treated more carefully and are not discarded lightly. Since they are, understandably, less fragile than the ceramics or glass, they can rarely be found among the waste material prevailing among the archaeological findings in settlements and residential structures.

Although relatively fewer in number, metal artefacts from Kiškorija clearly indicate what metal objects were used and possessed in this Roman rural settlement. In essence, these objects are mostly the ones intended for everyday use in agriculture, craftsmanship and housework, accompanied by an occasional item of traditional costumes. Apart from the undoubtedly agricultural tools, we find knives, which require no further discussion as to their wide-spread every-day use, parts of bronze vessels which were certainly used in the kitchen and for preparing meals, as well as various tools used for unavoidable and necessary tasks of everyday life of every rural settlement, such as needles and currier and carpentry tools. Parts of the costumes are not so numerous, but the fibulae and rings certainly do not present a surprising find in a village that had existed for centuries.

Some finds probably refer to the blacksmith, i.e. metallurgical activity, which again is quite understandable for this type of the site.

Although some of these items may be easily typologically differentiated and placed in a relatively specified time frame, the fact remains that a lot of them, especially tools, have been used, mainly in an unchanged form, throughout the Antiquity. Have they been, by any chance, accidental finds they could hardly be dated to a specific period. Fortunately, in this case the context of finds and radiometric analyses allowed us to date most items quite accurately.

## CATALOGUE OF METAL FINDS

- 1 Curry comb (Pl. 5: 10a–10b, fig. 182–183)  
We can assume that this is a tool the Romans called *scalprum*, or to be precise *scalptorium*. Our closest term





*rium*. Najbliži naš izraz bi bio češljagija, odnosno jedna vrsta strugalice i grebalice za čišćenje stoke.

Analogija: Popović 1988: 75, T. XII: 6

L 20 cm;<sup>1</sup> W 2,8 cm; M 211 g; željezo; 2.–5. st.

SJ 425; □ V 28/29, W 29; S–VI; N–307



Sl. 182 Češljagija  
Fig. 182 A curry comb

## 2. Komad željeza

Za pretpostaviti je da je riječ o tragu neke metalurške djelatnosti, komad je previše amorfan da bi se mogao pripisati nekom konkretnom artefaktu. Pobliza datacija nije moguća.

L 2,8 cm; W 1,5 cm; M 3 g; željezo; 2.–5. st.

SJ 114; □ W/X 28; S–VI; N–146

## 3. Nož (T. 9: 6)

Veći nož, uobičajenog utilitarnog tipa, većim je dijelom sačuvan, no nedostaje mu vrh sječiva. Površina noža je korodirala te nema vidljivih tragova finije obrade.

L 25,5 cm; L (sječivo) 15,5 cm; W 3,4 cm; M 86 g; željezo; 2.–4. st.

SJ 076; □ Y28; S–VI; PN–12

## 4. Fragment ručke (T. 9: 10)

Predmet je oštećen i tek djelomično sačuvan, no čini se da bi moglo biti riječ o maloj ručki, posude ili možda vjerojatnije kovčežića.

L 4,5 cm; W 0,5 cm; M 4 g; željezo; 2.–4. st.

SJ 104; □ X 27; S–VI; N–121

## 5. Nož (T. 12: 11)

Riječ je o dosta dobro sačvanom malom željeznom nožu utilitarnog tipa, karakterističnog za kasnoantičko razdoblje. Samo mu nedostaje vrh sječiva. Površina je korodirala zbog čega nisu vidljivi nikakvi tragovi ukrašavanje površine, inače dosta uobičajeni za ovaj tip.

Analogije: Ortisi 2006: 121–128

L 15,4 cm; L (sječivo) 9 cm; W 1–3,2 cm; M 31 g; željezo;

would be curry comb, i.e. a kind of scraper used for cleaning of livestock.

Analogy: Popović 1988: 75, Pl. XII: 6

L 20 cm;<sup>1</sup> W 2.8 cm; M 211 g; iron; 2<sup>nd</sup>–5<sup>th</sup> century.

SU 425; □ V 28/29, W 29; A–VI; F–307



Sl. 183 Češljagija, detalj  
Fig. 183 A curry comb, detail

## 2 A piece of iron

It is assumed that these are vestiges of some sort of a metallurgical activity; the piece is too amorphous to be attributed to a specific artefact. More precise dating is not possible.

L 2.8 cm; W 1.5 cm; M 3 g; iron; 2<sup>nd</sup>–5<sup>th</sup> century.

SU 114; □ W/X 28; A–VI; F–146

## 3 Knife (Pl. 9: 6)

A larger knife, of the usual utilitarian type, rather preserved, however, the tip of the blade is missing. The surface of the blade is corroded and there are no visible traces of finer processing.

L 25.5 cm; L (blade) 15.5 cm; W 3.4 cm; M 86 g; iron; 2<sup>nd</sup>–4<sup>th</sup> century.

SU 076; □ Y28; A–VI; SF–12

## 4 Fragment of a handle (Pl. 9: 10)

The item is damaged and only partially preserved, but it seems that it might be a small handle of a vessel or perhaps, more likely, of a small chest.

L 4.5 cm; W 0.5 cm; M 4 g; iron; 2<sup>nd</sup>–4<sup>th</sup> century.

SU 104; □ X 27; A–VI; F–121

## 5 Knife (Pl. 12: 11)

It is a well-preserved small iron knife of the utilitarian type, characteristic for the late Classical period. A tip of the blade is missing. The surface is corroded so the traces of surface decoration quite common for this type are not visible.

Analogy: Ortisi 2006: 121–128

L 15.4 cm; L (blade) 9 cm; W 1–3.2 cm; M 31 g; iron; 3<sup>rd</sup>–4<sup>th</sup> century.

1 L - dužina; W - širina; M - težina.

1 L - length; W - width; M - weight



- 3.–4. st.  
SJ 509; □ L 29; S –VII; PN–30
- 6.** Strugač ? (T. 12: 12)  
Alatka s trnom za nasad i pločicom trapezoidalnog oblika. Izgledom odgovara malim alatkama koje su interpretirane kao strugači, odnosno alatke za finu obradu ravnih površina. Pretpostavlja se uporaba u tesarstvu. Analogije: Dolenz 1998: 211, W307–W317  
L 7,5 cm; L (gornji dio) 3,4 cm; W 0,5–2,5 cm; M 7 g; željezo; 3.–4. st.  
SJ 510; □ L 29; S–VII; PN–32
- 7.** Ulomak (T. 12: 13)  
Savijeni željezni ulomak manjih dimenzija. Krajevi su mu oštećeni. Mada donekle podsjeća na kolut s nekog lanca, takva je interpretacija vrlo dvojbeni. L 2 cm; W 1 cm; M 3 g; željezo; 3.–4. st.  
SJ 510; □ L 29; S–VII; PN–32
- 8.** Grumen (T. 12: 14)  
Amorfni grumen željeza, vjerojatno je ostatak metalurške djelatnosti. Ne može se preciznije datirati. L 2 cm; W 1,2 cm; M 5 g; željezo; 2.–5. st.  
SJ 404; □ K/L 29/30; S–VII; N–325
- 9.** Željezni fragment (T. 12: 15)  
Izduženi željezni fragment nedefinirane namjene. Moguće je da se radi o ostatku metalurške aktivnosti na području naselja. Predmet je nemoguće pobliže datirati bez konteksta. L 3,5 cm; W 0,6 cm; M 2 g; željezo; 2.–5. st.  
SJ 404; □ K/L 29/30; S–VII; N–269
- 10.** Iгла (T. 12: 16)  
Djelomično sačuvana željezna igla. Nedostaju vrh i ušica igle. Moguća je uporaba u tekstilnom ili kožarskom obrtu. Jama u kojoj je nađena datirana je radiometrijskom metodom od 239. do 361. godine. L 5,6 cm; M 0,54 g, željezo; 3.–4. st.  
SJ 404; □ K 30; S–VII; PN–24
- 11.** Fragment noža (T. 12: 17)  
Slabo sačuvan željezni nož, odnosno dio nasada i donji dio sječiva. Tip je teško odrediti, no po dimenzijama vjerojatno se radi o običnom utilitarnom nožu za svakodnevnu uporabu. Po kontekstu nalaza se može datirati u 3., odnosno prvu polovicu 4. stoljeća. L 8 cm; L (sječivo) 4,6 cm; W 1–2,8 cm; M 12 g; željezo; 3.–4. st.  
SJ 404; □ K 30; S–VII; PN–25
- 12.** Fragment alatke (šilo ?) (T. 12: 18)  
Željezna šipka sa zadebljanom sredinom. Po svemu sudeći, nedostaju krajevi s obje strane. Prošireni središnji dio se vjerojatno koristio za držanje alatke, možda neke vrste šila.
- SU 509; □ L 29; A–VII; SF–30
- 6** Scraper ? (Pl. 12: 12)  
Scraper is a tool with a tang and a trapezoid plate. By its appearance it can be classified as a small tool interpreted as scraping iron i.e. a tool used for fine treatment of flat surfaces. It can be assumed that it was used in carpentry.  
Analogy: Dolenz 1998: 211, W307–W317  
L 7.5 cm; L (upper part) 3.4 cm; W 0.5–2.5 cm; M 7 g; iron; 3<sup>rd</sup>–4<sup>th</sup> century.  
SU 510; □ L 29; A–VII; SF–32
- 7** Fragment (Pl. 12: 13)  
Small folded piece of iron, with its ends damaged. Although somewhat reminiscent of the hoop from a chain, this interpretation is very doubtful.  
L 2 cm; W 1 cm; M 3 g; iron; 3<sup>rd</sup>–4<sup>th</sup> century.  
SU 510; □ L 29; A–VII; SF–32
- 8** Nugget (Pl. 12: 14)  
An amorphous nugget of iron, probably residue of the metallurgical activity. It cannot be precisely dated.  
L 2 cm; W 1.2 cm; M 5 g; iron; 2<sup>nd</sup>–5<sup>th</sup> century.  
SU 404; □ K/L 29/30; A–VII; F–325
- 9** Iron fragment (Pl. 12: 15)  
Elongated iron fragment of undefined purpose. It is possibly a residue of the metallurgical activity in the village. It is impossible to date the item without a context.  
L 3.5 cm; W 0.6 cm; M 2 g; iron; 2<sup>nd</sup>–5<sup>th</sup> century.  
SU 404; □ K/L 29/30; A–VII; F–269
- 10** Needle (Pl. 12: 16)  
Partly preserved iron needle. The tip and the eye of the needle are missing. It could have been used in the textile or carrier crafts. The pit in which it was found is dated by radiometric method from 239 to 361.  
L 5.6 cm; M 0.54 g, iron; 3<sup>rd</sup>–4<sup>th</sup> century.  
SU 404; □ K 30; A–VII; SF–24
- 11** Fragment of a knife (Pl. 12: 17)  
Poorly preserved iron knife, that is, a part of a tang and the lower part of the blade. It is difficult to determine the type, but according to the size it is probably an ordinary utilitarian knife for everyday use. By the context it can be dated to the 3<sup>rd</sup> or the first half of the 4<sup>th</sup> century.  
L 8 cm; L (blade) 4.6 cm; W 1–2.8 cm; M 12 g; iron; 3<sup>rd</sup>–4<sup>th</sup> century.  
SU 404; □ K 30; A–VII; SF–25
- 12** Fragment of a tool (scribe ?) (Pl. 12: 18)  
Iron bar with a thicker middle section. By all odds, both ends are missing. Widened middle section was presumably used for holding of the tool, probably a type of a scribe.



Analogije: Dolenz 1998: 221, W 389  
L 13,5 cm; W 0,3–0,5 cm; M 13 g; željezo; 2.–4. st.  
SJ 449; □ K/L 29/30; S–VII; PN–27

Analogy: Dolenz 1998: 221, W 389  
L 13.5 cm; W 0.3–0.5 cm; M 13 g; iron; 2<sup>nd</sup>–4<sup>th</sup> century.  
SU 449; □ K/L 29/30; A–VII; SF–27

### 13. Posuda (T. 12: 19, sl. 184)



Sl. 184 Ulomak brončane posude  
Fig. 184 A fragment of a bronze vessel

Riječ je o ulomku ruba posude, moguće neke plitke zdjele. Izvijeni profilirani rub ukrašen je vertikalnim urezima. Gornji dio tijela posude ukrašen je prstenastim pojasom, ispod kojeg slijedi horizontalna linija koja također obrubljuje tijelo posude. Rezultati analize starosti ugljena s dna jame u kojoj je nađen ovaj fragment ukazuju na razdoblje od 239. do 361. godine, te se i ovaj fragment može okvirno datirati od prve polovine 3. do sredine 4. stoljeća.

L 5,5 cm; W 3,2 cm; M 20 g; bakrena slitina; 2.–3. st.  
SJ 404; □ L 30; S–VII; PN–22

### 13 Vessel (Pl. 12: 19, fig. 184)

The fragment is a part of the rim of a vessel, possibly a shallow bowl. Curved moulded rim is decorated with vertical cuts. The upper part of the body is decorated with an annular band below which there is a horizontal line that also encircles the body of a vessel. Results of the analysis of the coal from the bottom of the pit, in which the fragment was found, indicate the period of 239 to 361, so that this fragment can also be dated to the first half of the 3<sup>rd</sup> to mid-4<sup>th</sup> century.

L 5.5 cm; W 3.2 cm; M 20 g; copper alloy; 3<sup>rd</sup>–4<sup>th</sup> century.  
SU 404; □ L 30; A–VII; SF–22

### 14 Anvil ? (Pl. 14: 7)

Similar items found on Roman sites are usually interpreted as handy anvils for treatment of metal, but they may have been used by shoemakers for making footwear. It seems somewhat more likely that they were used by blacksmiths i.e. in metallurgy.

Analogy: Pietsch 1983: 55; Manning 1985: 42, E 35  
L 10.3 cm; W 5 cm; M 44 g; iron; 2<sup>nd</sup>–4<sup>th</sup> century.  
SU 168; □ N 32; A–VII; F–215

### 15 Fragment (Pl. 15: 15)

Fragment of elongated iron, S-shaped at one end. It cannot be said with certainty what it was or how it can be dated.

L 6.3 cm; W 1.5 cm; M 10 g; iron; 2<sup>nd</sup>–5<sup>th</sup> century.  
SU 642; □ E/F 3/4; A–IV; F–419

### 16 Fragment (of a knife ?) (Pl. 15: 16)

Rectangular iron fragment. It is possible that this is a central section of the blade of a knife. Precise dating of the fragment cannot be determined without the context of the finding.

L 5.5 cm; W 2.7 cm; M 6 g; iron; 2<sup>nd</sup>–5<sup>th</sup> century.  
SU 642; □ E/F 3/4; A–XIV; F–419

### 14. Nakovanj ? (T. 14: 7)

Ovakvi se predmeti pronađeni na rimskim lokalitetima najčešće interpretiraju kao priručni nakovnji za obradu lima, no katkad nije isključena ni uporaba od strane postolara koji su ih rabili prilikom izrade obuće. Kovačka, odnosno metalurška namjena se čini nešto vjerojatnija. Analogija: Pietsch 1983: 55; Manning 1985: 42, E 35

L 10,3 cm; W 5 cm; M 44 g; željezo; 2.–4. st.  
SJ 168; □ N 32; S–VII; N–215

### 15. Fragment (T. 15: 15)

Fragment željeza izduženog oblika koji se na jednom kraju izvija u obliku slova S. Ne može se sa sigurnošću reći o kakvom se predmetu radi niti ga je moguće preciznije datirati.

L 6,3 cm; W 1,5 cm; M 10 g; željezo; 2.–5. st.  
SJ 642; □ E/F 3/4; S–SIV; N–419

### 16. Fragment (noža?) (T. 15: 16)

Željezni fragment pravokutnog oblika, plošnog presje-

### 17 Key (Pl. 18: 14, fig. 185)



Sl. 185 Željezni ključ  
Fig. 185 An iron key



ka. Moguće je da se radi o središnjem dijelu sječiva noža. Preciznu dataciju fragmenta nije moguće odrediti bez konteksta nalaza.

L 5,5 cm; W 2,7 cm; M 6 g; željezo; 2.–5. st.  
SJ 642; □ E/F 3/4; S–XIV; N–419

**17. Ključ** (T. 18: 14, sl. 185)

Željezni ključ za bravu sa zasunom na potezanje s drškom u obliku pravokutne pločice s kružnim otvorom na kraju koji nije sačuvan u cijelosti. Dio za ključanicu ima četiri zupca, vanjski su pravokutnog oblika, a unutarnji trokutastog.

Analogija: Čargo 2002: 551; Zbirka Pavletić 2003: 111, kat. 259 a–g

L 9,1 cm; W 0,5–3,5 cm; M 29 g; željezo; 2.–3. st.  
SJ 1339; □ (K 27); S–XVI; PN–656

**18. Fibula** (T. 19: 10, sl. 186)



Sl. 186 Ulomak brončane fibule  
Fig. 186 A fragment of a bronze fibula

Sačuvan je fragment lukovičaste fibule, odnosno dio zglobnog tuljca s postraničnim heksagonalnim dugmetom. Sam fragment nije lako pobliže datirati unutar poznatog kronološkog okvira izrade i uporabe lukovičastih fibula, no kontekst nalaza, odnosno radiometrijska analiza, upućuju na prvu polovicu 5. stoljeća.

Analogije: Koščević 1980: 57, T. XLV: 123  
L 2,1 cm; W 0,5–0,7 cm; M 3 g; bakrena slitina; prva polovica 5. st.

SJ 1363; □ (J 25); S–XVII; PN–45

**19. Zvono** (T. 19: 11, sl. 187–188)

Zvono pravokutne osnove s kapljicaštim zadebljanjima na kutovima. Sačuvano je i željezno klatno. Vanjska je površina glatka, bez ukrasa, dok je s unutarnje strane vidljiv lijevani znak križa, odnosno znak u obliku slova X. Analogna zvona, vjerojatno namijenjena vješanju oko vrata stoci, čest su nalaz na rimskim lokalitetima, a mogu se datirati u širok vremenski raspon. U ovom slučaju imamo dosta precizno datiran kontekst, zahvaljujući analizi starosti ugljena, tako da s velikom sigurnošću zvonce možemo datirati u 5. stoljeće.

Iron key for a lock with a latch to pull, with a handle in the shape of a rectangular plate with a circular opening at the end, which is not entirely preserved. Part that goes into the keyhole has four prongs; the ones on the outside have a rectangular shape and the inner ones a shape of a triangle.

Analogy: Čargo 2002: 551; Zbirka Pavletić 2003: 111, kat. 259 a–g

L 9.1 cm; W 0.5–3.5 cm; M 29 g; iron; 2<sup>nd</sup>–3<sup>rd</sup> century.  
SU 1339; □ (K 27); A–XVI; SF–656

**18 Fibula** (Pl. 19: 10, fig. 186)

A fragment of a crossbow fibula, i.e. a part of a hinge cylinder with hexagonal side-button, is preserved. The fragment alone cannot be closely dated within the known chronological frame of the production and use of crossbow fibulae, but the context of the finding, i.e. the radiometric analysis, point to the first half of the 5<sup>th</sup> century.

Analogy: Koščević 1980: 57, T. XLV: 123

L 2.1 cm; W 0.5–0.7 cm; M 3 g; copper alloy; first half of the 5<sup>th</sup> century.

SU 1363; □ (J 25); A–XVII; SF–45

**19 Bell** (Pl. 19: 11, fig. 187–188)



Sl. 187 Brončano zvono  
Fig. 187 A bronze bell

Rectangular bell, with a drop-like thickening at the corners. The iron pendulum is preserved as well. The outer surface is smooth, without ornamentation, while on the inside, the cast sign of the cross, i.e. a X-shaped sign, is visible. Analogue bells, probably intended for hanging on the neck of cattle, are common findings on Roman sites, and can be broadly dated. In this case, we have a quite accurately dated context, thanks to the analysis of the coal, so that we can, with great certainty, date the bell to the 5<sup>th</sup> century.

Analogy: Zbirka Pavletić 2003: 115, sl. 277b

H 6 cm; W 3.2x4.7 cm; M 71 g; copper alloy and iron; 5<sup>th</sup> century.

SU 1363; □ (J 24/25); A–XVII; SF–44

**20 Knife** (Pl. 19: 12)



Sl. 188 Brončano zvono (detalj unutrašnjosti)  
Fig. 188 A bronze bell (detail of the interior)

Analogije: Zbirka Pavletić 2003: 115, sl. 277b  
H 6 cm; W 3,2 x 4,7 cm; M 71 g; bakrena slitina i željezo; 5. st.  
SJ 1363; □ (J 24/25); S–XVII; PN–44

#### 20. Nož (T. 19: 12)

Mali željezni nož nije sačuvan u cijelosti, nedostaje mu vrh sječiva. Na površini nisu vidljivi tragovi dekoracije. Analogije: Ortisi 2006: 121–128  
L 11,5 cm; L (sječivo) 7 cm; W 1,8–2,4 cm; M 19 g; željezo; prva polovica 5. st.  
SJ 1363; □ (J 24/25); S–XVII; PN–50

#### 21. Čavli (T. 19: 13–14)

Željezni čavli u potpunosti su sačuvani. S obzirom na dimenzije, vjerojatno su se koristili u građevinske svrhe. Budući da se takav oblik čavla koristi tijekom cijelog razdoblja rimskog carstva, ali i kasnije, ne može ih se precizno datirati, vjerojatno su korišteni tijekom postojanja naselja.  
L 9 cm, 9,2 cm; W 2 cm, 1,5 cm; M 32 g, 24 g željezo; 2.–5. st.  
SJ 1363; □ (J 24/25); S–XVII; N–456

#### 22. Motika (T. 19: 15, sl. 189)

Generički latinski izrazi za motiku su, po svemu sudeći, bili *sarculum* i *ligo*. Kao oruđe široke primjene u poljoprivredi, posebice u kultivaciji žitarica i vrtlarskim poslovima, ne čudi velik broj nalaza po rimskim lokalitetima. Tipološki riječ je o alatu koji ne pokazuje brojne varijacije, a razlike između pojedinih tipova u načelu se odnose na izgled sječiva. Ova je motika sačuvana je gotovo u cijelosti, sječivo joj je naglašenog deltoidnog oblika sa zaobljenim krajem. Ušica je ovalnog oblika i dosta masivna. S obzirom na to da sječivo nije pretjerane debljine, alatka bi se mogla definirati kao laka motika, prvenstveno namijenjena vrtlarstvu, odnosno okopavanju manjeg raslinja, razvlačenje gnojiva i

Small partly preserved iron knife; the tip of the blade is missing. There are no traces of decoration on the surface. Analogy: Ortisi 2006: 121–128  
L 1.5 cm; L (blade) 7 cm; W 1.8–2.4 cm; M 19 g; iron; first half of the 5<sup>th</sup> century.  
SU 1363; □ (J 24/25); A–XVII; SF–50

#### 21 Nails (Pl. 19: 13–14)

Fully preserved iron nails. According to their dimensions they were probably used for construction purposes. Since this type of nails is used during the entire period of the Roman Empire, and later, they cannot be precisely dated. They were probably used during the entire existence of the settlement.  
L 9 cm, 9.2 cm; W 2 cm, 1.5 cm; M 32 g, 24 g; iron; 2<sup>nd</sup>–5<sup>th</sup> century.  
SU 1363; □ (J 24/25); A–XVII; F–456

#### 22 Mattock (Pl. 19: 15, fig. 189)



Sl. 189 Željezna motika  
Fig. 189 An iron mattock

Generic Latin words for a mattock were, apparently, *sarculum* and *ligo*. As it was widely used in agriculture, especially in cultivation of cereals and in horticulture, it is only normal that many of these were found on Roman sites. Typologically, it is a tool that does not have many variations and differences between individual types generally refer to the appearance of the blade. This mattock has been preserved almost entirely; its blade is pronouncedly delta-shaped with a rounded end. Central eye is oval and quite massive. Given the fact that the blade is not excessively thick, a tool could be defined as a light mattock, primarily intended for gardening or cultivating small plants, stretching the fertilizer and covering the seeds. Given the context of the finding, and analysis of the coal found in the pit in which the tool was discovered, the mattock can undoubtedly be dated to the 5<sup>th</sup> century. Analogy: Popović 1988: 39, T. III: 4, T. XXXIV: 7  
L 26 cm; W 24.5 cm; d (central eye) 3 x 4 cm; M 1650 g; iron; 5<sup>th</sup> century.  
SU 1363; □ (J 25); A–XVII; SF–48

#### 23 Pick (Pl. 19: 16, fig. 190)



pokrivanje sjemenja.

S obzirom na kontekst nalaza, odnosno analizu starosti ugljena pronađenog u jami gdje je otkrivena ova alatka, motika se nesumnjivo može datirati u 5. stoljeće.

Analogije: Popović 1988: 39, T. III: 4, T. XXXIV: 7

L 26 cm; W 24,5 cm; *d* (otvor za nasad) 3 x 4 cm; M 1650 g; željezo; 5. st.

SJ 1363; □ (J 25); S–XVII; PN–48

### 23. Budak (T. 19: 16, sl. 190)



Sl. 190 Željezni budak

Fig. 190 An iron pick

Željezni budak sačuvan je u cijelosti. Sudeći po rimskim izvorima, ovaj tip oruđa nazivao se *sarculum* ili *marra*. Drugi je termin vjerojatno adekvatniji jer je *sarculum* generički izraz za motiku, dok bi tip sa težim sječivom, odnosno budak, bilo primjerenije zvati *marra*. Takvim se alatom razbijala i usitnjavala tvrda zemlja prilikom poljoprivrednih i općenito zemljanih radova. Ovaj budak ima usko, pri kraju blago prošireno sječivo, te kružni otvor za dršku. Sječivo pada pod blagim kutom u odnosu na usicu.

Alatke ovog tipa se tipološki nisu bitno mijenjale tijekom antičkog razdoblja, pa je kontekst ključan za određivanje približne datacije. U ovom konkretnom slučaju, budak potječe iz zapune SJ 1363, u kojoj je nađeno mnoštvo ulomaka kasnoantičke keramike kao i određen broj metalnih artefakata. Zahvaljujući analizi ugljena, zapuna se može okvirno datirati od 412. do 534. godine, te se i ovaj budak može smjestiti u taj kronološki okvir, odnosno datirati u 5. stoljeće.

Analogije: Popović 1988: 36–37, T. I: 3–5

L 18 cm; W 5 cm; *d* (otvor za nasad) 3,4 x 2,6 cm; M 648 g; željezo; 5. st.

SJ 1363; □ (J 25); S–XVII; PN–49

### 24. Fragment (T. 20: 10)

Teško je reći o čemu se točno radi. Izduženi plosnati oblik navodi na pomisao da bi mogla biti riječ o nekoj oplati, no nema tragova zakovica. Ukoliko je u pitanju fragment nekog oruđa, možda bi u obzir dolazila neko tesarsko oruđe za finu obradu površina, neka vrsta dlijetla - s obzirom da je jedan kraj zašiljen - no nema pouzdanih analogija.

L 20 cm; W 1 cm; M 51 g; željezo; 2.–5. st.

SJ 1708; □ (H 17); S–XIX; PN–60

Completely preserved iron pick. Judging by the Roman sources, this type of a tool was called *sarculum* or *marra*. The second term is probably more suitable because *sarculum* is a generic term for a mattock, while it would be more appropriate to call the tool with the heavier blade, i.e. pick, *marra*. Such tools were used to break and chop hard soil in farming activities and earthworks in general. This pick has a narrow blade, slightly expanded at the end, and a circular central eye for fitting the handle. The blade is tilted at a slight angle in regard to the central eye.

The typology of this type of tools did not change significantly during the antique period, so the context is crucial for more precise determination of dates. In this particular case, the pick comes from the backfill SU 1363, where plenty of fragments of late antique pottery, as well as a number of metal artefacts were found. Thanks to the analysis of coal, backfill can be roughly dated from 412 to 534, so that this particular pick can be placed in the same chronological frame, that is, it can be dated to the 5<sup>th</sup> century.

Analogy: Popović 1988: 36–37, T. I: 3–5

L 18 cm; W 5 cm; *d* (central eye) 3.4 x 2.6 cm; M 648 g; iron; 5<sup>th</sup> century.

SU 1363; □ (J 25); A–XVII; SF–49

### 24 Fragment (Pl. 20: 10)

It's hard to say what this item represents. The elongated flat shape suggests that this might be some kind of a revetment, but there are no traces of rivets. If it is the fragment of a tool, a carpenter tool for fine surface treatment could be considered; a type of a chisel - given that one end is pointed - but there are no reliable analogies.

L 20 cm; W 1 cm; M 51 g; iron; 2<sup>nd</sup>–5<sup>th</sup> century.

SU 1708; □ (H 17); A–XIX; SF–60

### 25 Bead (Pl. 21: 10)

Small bead with no visible traces of dressing. Irregular oval shape, with a visible symmetrical hole. The exact purpose is unclear.

*d* 0.5 cm; M 0,83 g, copper alloy; 2<sup>nd</sup>–5<sup>th</sup> century.

SU 1852; □ (F 14); A–XIX; SF–61

### 26 Nugget (Pl. 21: 11)

Irregularly shaped iron nugget. It is possible that this is a residue of blacksmith activity, that is of metallurgical activities that took place at the site. More precise dating is not possible.

Dimensions: 1.6 x 2.4 cm; M 5 g; iron; 2<sup>nd</sup>–5<sup>th</sup> century.

SU 1852; □ F14; A–XIX; SF–56

**25.**Zrno (T. 21: 10)

Zrno malih dimenzija, bez vidljivih tragova obrade. Nepravilnog je ovalnog oblika, no na zrnu je vidljiva pravilna rupa. Točna namjena nije jasna.

d 0,5 cm; M 0,83 g, bakrena slitina; 2.–5. st.

SJ 1852; □ (F 14); S–XIX; PN–61

**26.**Grumen (T. 21: 11)

Željezni grumen nepravilna oblika. Moguće je da se radi o tragu kovačke, odnosno metalurške djelatnosti koja se odvijala na lokalitetu. Pobliza datacija nije moguća.

dimenzije 1,6 x 2,4 cm; M 5 g; željezo; 2.–5. st.

SJ 1852; □ F14; S–XIX; PN–56

**27.**Sječivo noža? (T. 23: 7)

Čini se da je riječ o fragmentu noža, odnosno sječiva.

L 8,6 cm; W 0,5-1,7 cm; M 10 g; željezo; 2.–5. st.

SJ 1978; □ (F 7); S–XXI; PN–58

**28.**Nož (T. 24: 6)

Željezni nož, sačuvan većim dijelom, s izvijenim hrptom i blago konkavnim sječivom. Ovakvi noževi, male do srednje veličine, dosta su uobičajeni tijekom rimskog razdoblja, te ih nije lako poblize datirati, ukoliko ne postoji jasan kontekst. U ovom slučaju se vjerojatno može okvirno datirati od 2. do 4. stoljeća.

L 14,9 cm; W 1–2 cm; M 29 g; željezo; 2.–4. st.

SJ 2155; □ (F 10), S–XX; PN–55

**29.**Fragment fibule (T. 24: 7, sl. 191)

Riječ je o fragmentu tzv. snažno profilirane fibule. Većim ili manjim dijelom sačuvani su donji dio luka, disk na luku, gornji dio luka, glava fibule, baza glave, ležište osovine spirale i tetive, kao i kuka tetive. Glava je blago facetirana, a relativno oštri profili i rubovi su možda posljedica nedostatne dorade nakon vađenja iz kalupa.

Fragmentarno stanje nam ne omogućava pouzdano određivanje podtipa, odnosno varijante ovog primjerka, no izraženo povijanje glave fibule prema unutra bi moglo upućivati na bliskost s mlađim varijantama snažno profiliranih fibula. Stoga se ovaj fragment može okvirno datirati u 2. stoljeće, odnosno najranije u sam kraj 1. stoljeća.

Analogije: Almgren 1923: 37–38, Fig. 73; Koščević 1980: 23, T. XVII: 116–118; Bojović 1983: 35–36, T. IX: 79; Kovrig 1937: 116–117

H 1,1 cm; L 2,9 cm; W 1 cm; M 4 g; bakrena slitina; 2. st.

SJ 2242; □ (D 9); S–XXI; PN–59

**30.**Fragment posude s ručkom (T. 26: 6, sl. 192)

Oštećena posuda od bakrene slitine. Djelomično je sačuvan obod i gornji dio tijela posude te manji dio

**27** Blade of a knife ? (Pl. 23: 7)

It appears to be a fragment of a knife, probably its blade.

L 8.6 cm; W 0.5-1.7 cm; M 10 g; iron; 2<sup>nd</sup>–5<sup>th</sup> century.

SU 1978; □ (F 7); A–XXI; SF–58

**28** Knife (Pl. 24: 6)

Considerably preserved iron knife, with arched ridge and slightly concave blade. Such knives, small to medium-size, are quite common throughout the Roman period, and they are not easy to date with precision, unless there is a clear context. In this case, we can probably date them to the 2<sup>nd</sup>–4<sup>th</sup> century.

L 14.9 cm; W 1-2 cm; M 29 g; iron; 2<sup>nd</sup>–4<sup>th</sup> century.

SU 2155; □ (F 10), A–XX; SF–55

**29** Fragment of a fibula (Pl. 24: 7, fig. 191)

Sl 191 Ulomak brončane fibule

Fig. 191 A fragment of a bronze fibula

It is a fragment of the so called strongly profiled fibula. The lower section of the bow, disc on the bow, the upper part of the bow, the head of the fibula, the base of the head, the ledge of the shaft of the whorl and of the string, as well as the rump of the string are all preserved to the larger or a lesser extent. The head is slightly faceted, while relatively sharp profiles and edges may be the result of a lack of finishing after the fibula was taken out of the mould.

Fragmentary condition does not enable reliable determination of a subtype, that is of a variation of this particular sample, but the pronounced inward curvature of the head of the fibula might indicate coherence with the younger versions of strongly profiled fibulae. Therefore, this fragment can be roughly dated to the 2<sup>nd</sup> century, or to the end of the 1<sup>st</sup> century at the earliest.

Analogy: Almgren 1923: 37–38, Fig. 73; Koščević 1980: 23, T. XVII: 116–118; Bojović 1983: 35–36, T. IX: 79; Kovrig 1937: 116–117

H 1.1 cm; L 2.9 cm; W 1 cm; M 4 g; copper alloy; 2<sup>nd</sup> century.

SU 2242; □ (D 9); A–XXI; SF–59

**30** Fragment of a vessel with a handle (Pl. 26: 6, fig. 192)



ručke uz obod. Ručka je lagano povijena prema gore. Uslijed fragmentarnog stanja, nemoguće je sa sigurnošću odrediti točan tip posude. Po svemu sudeći, imala je samo jednu ručku, a oblikom podsjeća na kase-role, pa i na cjedila. S obzirom da nedostaje veći dio posude ispod obruba, nije sasvim isključena mogućnost da je riječ o cjedilu.

Analogije: Eggers 1951: 146–147?, Eggers 1951: 159–161? L 6,1 cm; d 12,7 cm; M 52 g, bakrena slitina, 2.–4. stoljeće SJ 001; □ X 27; S–VI; PN–1

### 31. Ručka cjedila (T. 26: 7)

Vrlo je vjerojatno riječ o ručki cjedila. Kraj ručke je sačuvan, ali nisu vidljivi nikakvi tragovi ukrasa. Središnji dio, također bez ukrasa, proširen je. Gornji dio ručke djelomično je sačuvan, na krajevima je izlisan. Površina ručke je korodirala te nisu sačuvani tragovi obrade. Čini se da bi ova ručka odgovarala cjedilima tipa Egger 160 ili 161, te bi je sukladno toj interpretaciji mogli datirati u 2. i 3. stoljeće.

Analogije: Radnóti 1938: 75; Eggers 1951: 160–161 L 13,4 cm; W 1,9–4,9 cm; M 46 g, bakrena slitina, 2.–3. stoljeće SJ 001; □ X27; S–VI; PN–2

### 32. Prsten (T. 26: 8, sl. 193)

Srebrni prsten s kruništem u koje je umetnuta gema. Obruč prstena nepravilnog je oblika. Unutarnja strana je plosnata, dok je vanjska zaobljena. Obruč se postepeno širi prema kruništu koje se stepenasto uzdiže iznad ramena. Na gemi su vidljivi tragovi graviranja, međutim prikaz nije dovršen te je samim time neodrediv. Iako je kontekst nalaza manjkav (riječ je o površinskom nalazu), datacija nije sporna jer se prstenje ovog oblika načelno datira kroz drugu polovicu 2. i cijelo 3. stoljeće.

Analogije: Guiraud 1989: 185–186 d 1,4–1,7 cm; WT. 0,4 cm; gema 0,9–1,2 cm; M 4 g; srebro, karneol; 2.–3. st. SJ 001; □ W 28; S–VI; PN–3

### 33. Prsten (T. 26: 9)

Obruč prstena pravilnog je oblika, s unutarnje strane je plosnat, dok je vanjska strana zaobljena. Na nasuprotnim stranama vanjske stijenke prstena sačuvana je po jedna istaka, možda je riječ o reparaturi. Zbog loše sačuvanosti površinskog dijela prstena, ne uočava se finija obrada prstena, kao ni postojanje ukrasa. Iznimno jednostavan oblik nije moguće pobliže datirati – tim više što je riječ o površinskom nalazu – te zbog toga ovaj prsten možemo okvirno datirati u vrijeme trajanja naseljavanja ovog lokaliteta, odnosno od 2. do 5. stoljeća. d 2 cm; WT. 0,5 cm; M 1,48 g; bakrena slitina; 2.–5. st. SJ 001; □ ?; S–XX; N–52

Damaged copper alloy vessel. Partly preserved rim and upper part of the body and a smaller part of the handle alongside the rim. The handle is slightly curved upwards. Due to the fragmentary condition, it is impossible to determine with certainty the exact type of a vessel. By all accounts, it had only one handle, and its shape is reminiscent of casseroles and even the strainers. Since the larger part of the vessel below the rim is missing, we cannot completely exclude the possibility that this is a strainer.

Analogy: Eggers 1951: 146–147?, Eggers 1951: 159–161? L 6.1 cm; d 12.7 cm; M 52 g, copper alloy, 2<sup>nd</sup>–4<sup>th</sup> century. SU 001; □ X 27; A–VI; SF–1



Sl. 192 Ulomak posude s ručkom

Fig. 192 A fragment of a vessel with a handle

### 31 Handle of a strainer (Pl. 26: 7)

Probably a handle of a strainer. The end of the handle is preserved, but there are no visible traces of decoration. The central part, also undecorated, is expanded. The upper part of the handle is partially preserved, but worn out at its ends. The surface of the handle is corroded and no traces of dressing are preserved. It seems that this handle would fit strainers of the Egger 160 or 161 type, and according to this interpretation could be dated to the 2<sup>nd</sup> and the 3<sup>rd</sup> century.

Analogy: Radnóti 1938: 75; Eggers 1951: 160–161 L 13.4 cm; W 1.9–4.9 cm; M 46 g, copper alloy, 2<sup>nd</sup>–3<sup>rd</sup> century. SU 001; □ X27; A–VI; SF–2

### 32 Ring (Pl. 26: 8, fig. 193)

A silver ring with a bezel setting in which a gem is inserted. A hoop of the ring is irregularly shaped. The inner side is flat, while the outer is rounded. The ring gradually expands toward the bezel, which gradually rises above the shoulders. Traces of engraving are visible on the gemstone, but the representation is unfinished and therefore indeterminate. Although the context of the finding is deficient (it is a surface find), dating is not controversial because the rings of this type generally date back to the second half of the 2<sup>nd</sup> and the entire 3<sup>rd</sup> century.

Analogy: Guiraud 1989: 185–186





Sl. 193 Prsten  
Fig. 193 A Ring

**34.** Fragment (vrh dlijeta?) (T. 28: 7)

Željezni fragment manjih dimenzija, otkriven u površinskom sloju. S obzirom na nepravilni piramidalni oblik vrha i četverokutni presjek trna, moguće je da se radi o vrhu dlijeta.

L 3,6 cm; W 1 cm; M 10 g; željezo; 2.-5. st.  
SJ 1018; □ (L/K 25/27); S-XVII; N-510

d 1.4-1.7 cm; WT. 0.4 cm; gemstone 0.9-1.2 cm; M 4 g;  
silver, carnelian; 2<sup>nd</sup>-3<sup>rd</sup> century  
SU 001; □ W 28; A-VI; SF-3

**33** Ring (Pl. 26: 9)

A hoop of the ring is regular in shape, the inner side is flat, while the outer is rounded. On the opposite sides of the outer wall of the ring two protrusions were preserved, possibly traces of a repair work. Due to the poor condition of the surface of the ring, neither the fine finishing nor the traces of decorations are visible. An extremely simple form cannot be closely dated - the more so as it is a surface find - which is why the ring can be dated to the time when this particular location was populated, or from the 2<sup>nd</sup> to the 5<sup>th</sup> century.

d 2 cm; WT. 0.5 cm; M 1,48 g; copper alloy; 2<sup>nd</sup>-5<sup>th</sup> century.

SU 001; □ ?; A-XX; F-52

**34** Fragment (tip of a chisel) (Pl. 28: 7)

Small iron fragment, found in the surface layer. Due to irregular pyramidal shape of the tip and a square cross-section of a tang, it is possible that it is a tip of a chisel. L 3.6 cm; W 1 cm; M 10 g; iron; 2<sup>nd</sup>-5<sup>th</sup> century.

SU 1018; □ (L/K 25/27); A-XVII; F-510

## Numizmatički nalazi s lokaliteta Virovitica Kiškorija Jug Numismatic finds from Virovitica Kiškorija South site

Anja Bertol

Prilikom sustavnih arheoloških istraživanja na položaju Kiškorija jug kod Virovitice pronađeno je pet numizmatičkih nalaza. Od spomenutih primjeraka novca, čak dva, koji su ujedno najstariji među njima, potječu iz iste zapune. To je zapuna L oblika SJ 425/426 koja je, osim navedena dva primjerka novca, sadržavala dosta ulomaka antičke keramike, brončanu cjediljku, željeznu sjekiru, ugljen, komade lijepa i gar (vidi poglavlje 2.3.1., 2. kompleks). Analizom ugljena iz zapune "L" oblika (SJ 425/426) ustanovljena je starost samog uzorka te se procjenjuje na razdoblje između 82.–226. AD, tj. od kraja 1. g. do prve polovine 3. st. po. Kr. Pretpostavljeno je da ova zapuna nije samostalna cjelina, već je vezana uz okolne objekte (Jelinčić 2006b: 62).

Prvi od dva primjerka novca iz spomenute zapune je sestercij Faustine II. iskovan u Rimu (kat. 1) (Bertol 2011: 236) dok je drugi zbog izlisanog aversa moguće odrediti samo kao sestercij viminacijske kovnice (kat. 2).

Na području Srednjeg i Donjeg Podunavlja u 3. st. zabilježena je velika prisutnost vojnih trupa koje su bile postavljene kako bi se uspješno borile protiv stranih napadača, ali rješavale i unutrašnje sukobe čiji je glavni cilj bio nametanje vlasti (Găzdac, Alföldy-Găzdac 2008: 136). Država je taj problem htjela riješiti otvaranjem lokalnih kovnica (Găzdac, Alföldy-Găzdac 2008: 136). Jedna od tih kovnica bila je kovnica provincijalnog novca u Viminaciju (Borić Brešković 1976; Kos 1992: 211–212; Găzdac, Alföldy-Găzdac 2008: 136). Utvrđeno je da gustoća numizmatičkih nalaza viminacijske kovnice opada što je veća udaljenost od centra proizvodnje (Nađ 2012: 392). Činjenica jest da je viminacijska kovnica u svoje vrijeme bila glavni dobavljač brončanog novca na Balkanu i imala je široku cirkulaciju novca u Gornjoj i Donjoj Panoniji, Gornjoj Meziji i Dalmaciji (Kos 1986: 109–110; 1992: 211–212). Stoga ne čudi jedan viminacijski brončani primjerak pronađen na lokalitetu Virovitica Kiškorija jug.

Preostala tri primjerka novca pripadaju carevima rođenima u Sirmiju: Probu (276.–282.) (kat. 5), Maksimijanu I. (286.–305.) (kat. 3) i Konstanciju II. (337.–361.) (kat. 4) (Bertol 2011: 236, 238).

Najstariji je novac sestercij Faustine II. (kat. 1) iskovan u Rimu dok je najmlađi novac Konstancija II (kat. 4), iskovan

During the systematic archaeological research at the Kiškorija south site near Virovitica five numismatic finds were discovered. Two of these coins, which are the oldest among these five, were found in the same backfill. It is the L-shaped backfill SU 425/426, which, in addition to the above mentioned two samples of coins, contained a lot of fragments of ancient pottery, bronze strainer, an iron axe, coal, pieces of daub and soot (see section 2.3.1., complex 2). The analysis of coal from the L-shaped backfill (SU 425/426) established the age of the sample which is estimated to the period between 82 and 226 AD, i.e. from the late 1<sup>st</sup> to the first half of the 3<sup>rd</sup> century. It is assumed that this backfill is not an independent entity, but that it is related to the surrounding buildings (Jelinčić 2006b: 62).

The first of the two copies of the said coins from the backfill is a *sestertius* of *Faustina II* minted in Rome (Cat. No. 1) (Bertol 2011: 236) while the other, due to its worn obverse, can be identified only as *sestertius* from the *Viminacium* mint (Cat. No. 2).

During the 3<sup>rd</sup> century, in the area of the Middle and the Lower Danube, a major presence of military troops was noted, placed there in order to successfully fight against the foreign invaders, but also to resolve internal conflicts whose main objective was to impose authority (Găzdac - Alföldy-Găzdac 2008: 136). The state wanted to solve this problem by establishing local mints (Găzdac - Alföldy-Găzdac 2008: 136). One of these was the mint of the provincial money in *Viminacium* (Borić Brešković 1976; Kos 1992: 211–212; Găzdac - Alföldy-Găzdac 2008: 136). It was determined that the density of the numismatic finds of the *Viminacium* mint decreases with the distance from the centre of production (Nađ 2012: 392). The fact is that the *Viminacium* mint was, in its time, the main supplier of bronze coins in the Balkans and that it had an extensive circulation of money in the Upper and the Lower Pannonia, Moesia Superior and Dalmatia (Kos 1986: 109–110, 1992: 211–212). Therefore, it is not surprising that one *Viminacium* bronze sample was found at Virovitica Kiškorija south site.

The remaining three samples of money belong to emperors born in *Sirmium*: *Probus* (276–282) (Cat. No. 5), *Maximian I* (286–305) (Cat. No. 3) and *Constantius II* (337–361) (Cat. No. 4) (Bertol 2011: 236, 238).

The oldest money is a *sestertius* of *Faustina II* (Cat. No.



između 351. i 355. g. u Sisciji.

Pregled numizmatičke topografije virovitičkog kraja donosi I. Mirnik 1986. g. Virovitičko područje nije osobito bogato numizmatičkim nalazima. Što se tiče pojedinačnih nalaza koji se čuvaju u Arheološkom muzeju u Zagrebu, vrijedi istaknuti jedan Neronov aureus (Virovitica) (Mirnik 1986: 112), kao i denare Vespazijana (Virovitica), Nerve (Virovitica), Trajana (Bukovica), Faustine II. (Bukovica) i Marka Aurelija (Virovitica) (Mirnik 1986: 112) te jedan Galijenov aureus (Virovitica). Čak 35 primjeraka pojedinačnih nalaza potječe iz mjesta Orešac (1. i 2. st.): Nervin sestercij, Domicijanov as, Trajanov sestercij, Trajanov ili Hadrijanov as, Hadrijanov sestercij, as Faustine I.; također novac 3. i 4. st., od Severa Aleksandra do Gracijana (Mirnik 1986: 110–111), brončani provincijalni primjerak kovan u Korintu za Hadrijana nađen je u Kapan-Ivancu, jedan slabo sačuvani as iz 1. st., dupondij 1. st. i sestercij 1. ili 2. st. (Mirnik 1986: 110) i denar Septimija Severa potječu iz Gačića, kao i brončani novac Konstantina Velikog, Konstancija II i Konstansa. Iz razdoblja kasne antike također potječe brončani novac Konstantina I., Konstansa i Konstantina II. iz Bukovice, Konstancija II. iz Borove (Mirnik 1986: 108) te slabo sačuvani primjerak iz sv. Đurađa (Mirnik 1986: 111). Među nalaze rimskog novca iz virovitičke okolice koji se ne čuvaju u Arheološkom muzeju u Zagrebu, spada Neronov zlatnik iz Pitomače (Mirnik 1986: 107). Prilikom arheoloških istraživanja 2007. i 2008. g. pronađeno je u Orešcu još osam primjeraka rimskog novca (Vespazijanov denar, dupondij Faustine I. ili II., denar Aleksandra Severa, sestercij Filipa I. te brončani novac Aurelijana, Konstantina I. i Konstancija II., uz još 22 primjerka prikupljena tijekom 2007. g. (dupondij Marka Aurelija, Galijenov antoninijan te 20 primjeraka brončanog novca 4. st.) koji se danas čuvaju u Gradskom muzeju u Virovitici (Bertol 2011: 238–259).

S virovitičkog područja potječe i ostava rimskog novca iz druge polovice 3. st. (u vremenu vladavine cara Galijena). To je ostava Bušetina kod Špišić Bukovice: 38 primjeraka novca od Gordijana III. do Galijena (Mirnik 1986: 108–110; Demo 1981: 214–227). Ranije je u literaturi bila poznata i ostava Virovitica: od Domicijana do Galijena (Mirnik 1981: 73, br. 246) koja je zapravo dio ostave Bušetina (Demo 1981: 214–227).

Primjerci novca s lokaliteta Virovitica-Kiškorija jug uklapaju se u cjelokupnu sliku cirkulacije rimskog novca u Panoniji (Nađ 2012: 385–409).

Novac s lokaliteta Virovitica Kiškorija jug čini značajan doprinos upotpunjavanju numizmatičke topografske karte virovitičkog kraja u razdoblju antike kao i pri dodatnom upoznavanju numizmatike u Gornjoj Panoniji izvan velikih centara. Važnost ovih nalaza leži i u tome što su rezultat sustavnih arheoloških istraživanja.

1) minted in Rome, while the youngest coin is the one of *Constantius II* (Cat. No. 4), minted between 351 and 355 in *Siscia*.

The overview of the numismatic topography of the Virovitica area is brought by I. Mirnik in 1986. Virovitica area is not particularly rich with numismatic finds. As far as the individual finds kept in the Archaeological Museum in Zagreb are concerned, the *aureus* of Nero (Virovitica) (Mirnik 1986: 112) is worth pointing out, as well as the *denarii* of *Vespasianus* (Virovitica), *Nerva* (Virovitica), *Traianus* (Bukovica), *Faustina II* (Bukovica) and *Marcus Aurelius* (Virovitica) (Mirnik 1986: 112) and one *aureus* of *Gallienus* (Virovitica). Up to 35 samples of individual finds originate from Orešac (1<sup>st</sup> and 2<sup>nd</sup> century: *sestertius* of *Nerva*, as of *Domitianus*, *sestertius* of *Traianus*, as of *Traianus* or *Hadrianus*, *sestertius* of *Hadrianus*, as of *Faustina I*; the money from the 3<sup>rd</sup> and the 4<sup>th</sup> century as well: from the period of *Severus Alexander* to *Gratianus* (Mirnik 1986: 110–111), a bronze provincial sample minted in Corinth for *Hadrianus* found in Kapan-Ivanec, one poorly preserved as from the 1<sup>st</sup> century, *dupondius* from the 1<sup>st</sup> century, *sestertius* from the 1<sup>st</sup> or the 2<sup>nd</sup> century (Mirnik 1986: 110) and a *denarius* of *Septimius Severus* originate from Gačiće as well as bronze coins of *Constantinus the Great*, *Constantius II* and *Constans*.

Bronze coins of *Constantinus I*, *Constantinus II* and *Constans*, from Bukovica, the one of *Constantius II* from Borova also originate from the Late Antiquity (Mirnik 1986: 108) as well as the poorly preserved sample from Sv. Đurađ (Mirnik 1986: 111). Among the finds of Roman coins from the Virovitica area that are not kept in the Archaeological Museum in Zagreb, there is one of Nero's gold coins from Pitomača (Mirnik 1986: 107). During archaeological excavations in 2007 and 2008 eight Roman coins (*denarius* of *Vespasianus*, *dupondius* of *Faustina I* or *II*, *denarius* of *Alexander Severus*, *sestertius* of *Philippus I* and bronze coins of *Aurelianus*, *Constantinus I* and *Constantius II*), with another 22 specimens collected during 2007 (*dupondius* of *Marcus Aurelius*, *antoninianus* of *Gallienus* and 20 samples of bronze coins dating to the 4<sup>th</sup> century) were found in Orešac and are kept in the City Museum in Virovitica (Bertol 2011: 238–259).

The hoard of Roman coins from the second half of the 3<sup>rd</sup> century also originates from the Virovitica area. (from the period of the reign of *Gallienus*). It is a Bušetina hoard near Špišić Bukovica: 38 coins from the times of *Gordianus III* until the times of *Gallienus* (Mirnik 1986: 108–110; Demo 1981: 214–227). From the earlier literature a Virovitica hoard is known: from *Domitianus* to *Gallienus* (Mirnik 1981: 73, no. 246), which is actually a part of the Bušetina hoard (Demo 1981: 214–227).

Samples of money from Virovitica Kiškorija south site fit into the overall image of the circulation of Roman coins in Pannonia (Nađ 2012: 385–409).

Money from the Virovitica Kiškorija south site makes a significant contribution to the completion of numismatic topographic map of the Virovitica area during the Antique period, as well as in additional learning about numismatics in Upper Pannonia outside major centres. The importance of these findings lies in the fact that they are a result of systematic archaeological research.



## KATALOG

1. **Faustina II.** (146.–175./176.)<sup>1</sup> (T. 5: 11a–11b, sl. 194)  
*Sestertius*; 26.25 g, 26,5 x 26,5 mm, 6 h  
 Av: FAVSTINA [AV]GVSTA  
 Poprsje desno, glava s kovrčavom kosom vezana na vratu.  
 Rv: [FECVN]D[ITAS]  
*Fecunditas* stoji desno, u desnoj ruci drži žezlo, u lijevoj dijete. U polju S C  
 Lit.: RIC III 1638  
 Kovnica: *Roma*  
 SJ 425; □ V 28/29 W 29; S–VI; PN–26

## CATALOGUE

- 1 **Faustina II** (146–175/176)<sup>1</sup> (PI 5: 11a–11b, Fig. 194)  
*Sestertius*; 26.25 g, 26.5 x 26.5 mm, 6 h  
 Obv: FAVSTINA [AV]GVSTA  
 A bust facing right, head with curly hair tied at the neck.  
 Rev: [FECVN]D[ITAS]  
*Fecunditas* standing on the right, holding a scepter in his right hand and a child in his left hand. S C in field.  
 Ref.: RIC III 1638  
 Mint: *Roma*  
 SU 425; □ V 28/29 W 29; A–VI; SF–26



SI 194 Faustina II  
 Fig. 194 Faustina II

2. **Gordianus III. – Gallienus** (T. 5: 12a–12b)  
*Sestertius*; 8,77 g, 26,6 x 24,4 mm  
 Av: neodrediv  
 Rv: [PM] S C[OL VIM]  
 Moesia stoji između bika i lava.  
 Lit.: Borić Brešković 1976 (poblje neodredivo)  
 Kovnica: *Viminacium*  
 Datacija: 239.–255.  
 SJ 425; □ V 28/29 W 29; S–VI; PN–29
3. **Maximianus I.** (285. –310.) (T. 19: 17)  
*Follis*; 5,93 g, 25 x 25 mm, 6 h  
 Av: IMP MAXIMIANVS P F AVG  
 Glava ovjenčana lovorovim vijencem desno.  
 Rv: SACRA MONET. AVGG ET. CAESS NOSTR  
 Moneta stoji lijevo, u desnici drži vagu, a u ljevici rog obilja. U polju desno Γ. U odsječku polumjesec i SIS.  
 Lit.: RIC VI 136b  
 Kovnica: *Siscia*  
 Datacija: 302.  
 SJ 1355; □ (K 24); S–XVII; PN–53
4. **Constantius II.** (337. –361.) (T. 20: 4, sl. 195)  
 AE 3; 1.87 g, 13.5 x 15.5 mm, 6 h  
 Av: DN CONSTAN-TIVS P F AVG

- 2 **Gordianus III – Gallienus** (PI 5: 12a–12b)  
*Sestertius*; 8.77 g, 26.6 x 24.4 mm  
 Obv: illegible  
 Rev: [PM] S C[OL VIM]  
 Moesia standing between the bull and the lion.  
 Ref.: Borić Brešković 1976 (poblje neodredivo)  
 Mint: *Viminacium*  
 Dating: 239–255  
 SU 425; □ V 28/29 W 29; A–VI; SF–29
- 3 **Maximianus I** (285–310) (PI 19: 17)  
*Follis*; 5.93 g, 25 x 25 mm, 6 h  
 Obv: IMP MAXIMIANVS P F AVG  
 Laureate bust facing right.  
 Rev: SACRA MONET. AVGG ET. CAESS NOSTR  
 Moneta standing on the left, holding scales in the right and the *cornucopiae* in the left hand. Γ in the field on the right. Crescent and SIS in the exergue.  
 Ref.: RIC VI 136b  
 Mint: *Siscia*  
 Dating: 302  
 SU 1355; □ (K 24); A–XVII; SF–53
- 4 **Constantius II** (337–361) (PI 20: 4, Fig. 195)  
 AE 3; 1.87 g, 13.5 x 15.5 mm, 6 h

1 Godine vladanja pojedinih careva iz kataloga preuzete su iz *Leksikona antičke numizmatike* (Kos 1998: 381–383).

1 The years of the reign of individual emperors were taken from the *Lexicon of antique numismatics* (Kos 1998: 381–383).



Sl. 195 Constantius II  
Fig. 195 Constantius II

Poprsje s vijencem od dijadema i draperijom desno.  
Rv: FEL TEMP REPARATIO  
Vojnik kopljem probada palog konjanika koji nosi frigijsku kapu, rukom naslonjen unatrag, štit na podu desno. U polju lijevo nešto piše. U odsječku A SIS.  
Lit.: RIC VIII 350; Bruck 1961: XIII, 20  
Kovnica: *Siscia*  
Datacija: 351.–355.  
SJ 1497; □ (K 24); S–XVII; PN–43

Obv: DN CONSTAN-TIVS P F AVG  
Bust facing right, with a diadem wreath and the drapery.  
Rev: FEL TEMP REPARATIO  
A soldier spearing a fallen horseman wearing a Phrygian cap, hand leaning backwards, shield on the ground on the right. Something written in the field on the left. A SIS in the exergue.  
Ref.: RIC VIII 350; Bruck 1961: XIII, 20  
Mint: *Siscia*  
Dating: 351–355  
SU 1497; □ (K 24); A–XVII; SF–43

260

5. **Probus** (276.–282.) (T. 26: 11, sl. 196)  
*Antoninianus*; 2.17 g, 18.5 x 19 mm, 6 h  
Av: IMP PROBVS P F AVG  
Poprsje sa zrakastom krunom, carskim ogrtačem i žezlom koje završava s prikazom orla lijevo.  
Rv: CONCORDIA MILIT  
Car stoji desno pružajući ruku Konkordiji, u odsječku T/XXI. Točkasti obrub.  
Lit.: RIC Vb 666  
Kovnica: *Siscia*  
Datacija: 276.–282.  
SJ 001; □ (J 24); S–XVII; PN–38

- 5 **Probus** (276–282) (T. 26: 11, sl. 196)  
*Antoninianus*; 2.17 g, 18.5 x 19 mm, 6 h  
Obv: IMP PROBVS P F AVG  
A bust with a radiate crown facing left; with an imperial cape and a sceptre surmounted by an eagle.  
Rev: CONCORDIA MILIT  
An emperor standing, extending a hand to *Concordia*. T/XXI in the exergue. Dotted border.  
Ref.: RIC Vb 666  
Mint: *Siscia*  
Dating: 276–282  
SU 001; □ (J 24); A–XVII; SF–38



Sl. 196 Probus  
Fig. 196 Probus

## 4.5.

### Tragovi metalurške djelatnosti *Traces of metallurgical activity*

Poglavlje je s razlogom nazvano tragovi metalurške djelatnosti budući da na nju upućuju samo skromni tragovi željezne troske i ulomci posuda za lijevanje metala iz SJ 1339/1340. Troska je pronađena na terenu na više lokacija (sl. 197–198). Raspršenost troske zapravo ne iznenađuje, budući da je cijeli koncept naselja zamišljen kao skup domaćinstava koja su nastojala što više zadovoljiti vlastite potrebe. Osim troske i posuda za lijevanje metala nije pronađen kovački alat, kao ni kovačka peć. S druge strane analiza metalnih predmeta ukazala je na prisutnost sitnog grumenja koji mogu predstavljati ostatke metalurške djelatnosti (vidi poglavlje 4.3), (Diedonné-Glad 1999: 41–42) prema čemu kovačka djelatnost u selu nije isključena.

The chapter is rightly called *Traces of metallurgical activity* since only modest traces of iron slag and fragments of metal ladle from SU 1339/1340 suggest the possibility of metallurgy. Slag was found on the site at several locations (fig. 197–198). Dispersion of slag is actually not surprising, since the whole concept of settlement is conceived as a set of households trying, as much as possible, to meet their own needs. The slag and metal ladles were found, but not the blacksmith tools or a blacksmith's kiln. On the other hand, analyses of metal objects indicate the presence of small nuggets that may represent the remains of metallurgical activities (see Section 4.3), (Diedonné-Glad 1999: 41–42), thus, blacksmith's activity in the village is not ruled out.

261



Sl. 197 Nalazi troske u sjevernom dijelu lokaliteta  
Fig. 197 Findings of slag in the northern part of the site

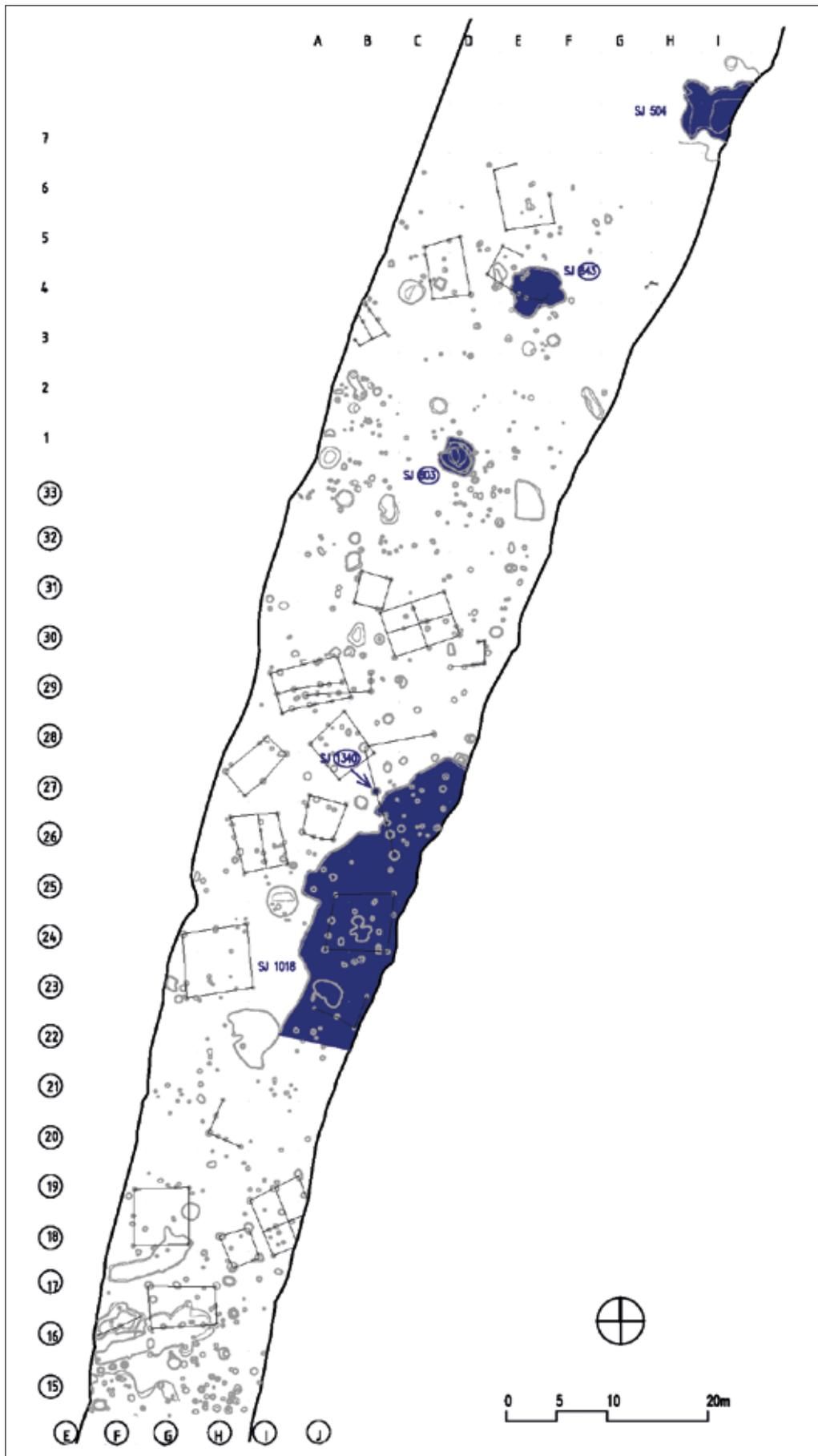

Sl. 198 Nalazi troske na južnom dijelu lokaliteta  
Fig. 198 Findings of slag in the southern part of the site

## Predmeti izrađeni od kamena, katalog Stone items, catalogue

Josip Halamić

Kristina Jelinčić Vučković

Nedostatak kamena i opeke kao građevinskog materijala te nalazi ukopa kao ostatak temeljenja drvenih stupova i velike količine lijepa s negativima daske i granja jasno govore o načinu gradnje objekata na lokalitetu Virovitica Kiškorija jug. Riječ je isključivo o objektima građanim od drvenih stupova, pruća, dasaka i lijepa. Nije nađen kamen kao građevinski materijal, ali su tijekom istraživanja od kamenih nalaza pronađeni brusovi, žrvnjevi, kremene alatke i nešto šljunka.

### Brusovi

Pronađeno je šest ulomaka kamenih brusova upotrebljavanih za oštrenje metalnih alata. U presjeku su uglavito oblikovani, s manjim otklonima, ovisno o tome koliko su bili upotrebljavani i o tvrdoći kamena. Površina je jako zaglađena uporabom. Pronađeni su na različitim mjestima na lokalitetu (sl. 166–167) što daje naslutiti kako su domaćinstva imala svoj pribor za oštrenje alata, odnosno da nisu postojali specijalizirani pojedinci koji su se time bavili.

Svi pronađeni ulomci brusova pregledani su makroskopski te su od njih napravljeni petrografski preparati koji su analizirani i mikroskopski. Svi ulomci pripadaju grupi klastičnih sedimentnih stijena i to siliciklastičnim pješčenjacima arenitnog i grauvaknog tipa. Petrografskom analizom ulomci iz SJ 1776 i SJ 1018 (kat. br. 2 i 6, sl. 199, 200) određeni su kao litične grauvake, ulomak iz SJ 424 (kat. br. 3, sl. 203) pripada grupi sublitoarenita, ulomak iz SJ 504-N 171 (kat. br. 5, sl. 202) determiniran je kao litični arenit, ulomak SJ 504-N 349 (kat. br. 4,) pripada grupi kvarcnih arenita, dok je ulomak iz SJ 954 (kat. br. 1, sl. 201), koji je i slabo metamorfoziran, određen kao litična metagrauvaka. Svi analizirani ulomci kamenih brusova sadrže od 60% do preko 95% kvarcnih zrna što te stijene čini tvrdima i pogodnima za brušenje metalnih alata (tvrdoća kvarca po Moosovoj skali je 7, a željeza oko 3). Osim toga, radi se o sitnozrnatim stijenama što je također jako povoljno za brušenje.

Što se tiče podrijetla materijala za analizirane ulomke brusova vrlo je teško bez detaljne usporedne analize s potencijalnih lokaliteta, odrediti područje iz kojeg one

Lack of stone and brick as a building material, finding of cuts remaining from the foundations of wooden poles and large amounts of daub with a negative impression of planks and branches, clearly show how the facilities on the site Virovitica Kiškorija south were constructed. There we have found only objects built of wooden poles, twigs, planks and daub. Stone as a building material was not discovered, but during the research grindstones, whetstones, flint tools and some gravel were found.

### Grindstones

Six fragments of grindstones used for sharpening of metal tools were found. They are angular in cross-section, with minor deviations, depending on how long they have been used and depending on the hardness of the stone. The surface has been smoothed by the use. The fragments were found at different locations on the site (fig. 166–167) suggesting that every household had their own utensils for tool sharpening, and that there were no individuals specialized for this work.

All of the grindstone fragments that were found were later examined macroscopically after what petrographic thin sections were made and analyzed microscopically. All fragments belong to the group of clastic sedimentary rocks, or to be precise, siliciclastic sandstones of arenite and greywacke type. Petrographic analysis of fragments from SU 1776 and SU 1018 (Cat. No. 2 and 6, fig. 199, 200) defined them as lithic greywacke, a fragment from SU 424 (Cat. No. 3, fig. 203) belongs to a group sublithoarenite, the one from SU 504-N 171 (Cat. No. 5, fig. 202) is defined as lithic arenite, a fragment from SU 504-F 349 (Cat. No. 4) belongs to the group of quartz arenites, while a fragment from SU 954 (Cat. No. 1, Fig. 201), which is slightly metamorphosed, is defined as lithic metagreywacke. All of the analyzed fragments of grindstones contain from 60% to over 95% of quartz grains which makes these rocks hard and suitable for abrading of metal tools (hardness of quartz, by Moos' scale is 7, and of iron around 3). Besides, these are fine-grained rocks that are very suitable for abrading.

It is very difficult to define the area of origin of the material used for the analysed of grindstones that were analyzed, without a detailed comparative analysis of the potential sites. Sandstone having the described petro-





potječu. Pješčenjake opisanih petrografskih obilježja nalazimo na Papuku, ali i na Meczeku u susjednoj Mađarskoj. Bez podrobne usporedne analize uzoraka s tih lokaliteta nije moguće reći radi li se uopće o uzorcima s tih lokaliteta.<sup>1</sup> Osim toga, s obzirom na to da se ovdje radi i o traženju robi za trgovanje u to vrijeme, a artefakti nisu velikih dimenzija, postoji i mogućnost transporta i iz udaljenijih nalazišta (npr. područja sadašnje Bosne i Hercegovine, Austrije, Italije itd.).

graphic features can be found on Papuk Mt., but also on Meczek Mt. in adjacent Hungary. Without a detailed comparative analysis of samples from those sites it is not possible to state if these samples originated from those sites at all.<sup>1</sup> Furthermore, due to the fact that these goods were also in demand for trading at that time, and that the artifacts are not large, a possibility of transport from more distant sites (e.g. the territory of Bosnia and Herzegovina, Austria, Italy etc.) should also be considered.



Sl. 199 Mikrofotografija litične grauivake (N=). Uzorak: SJ 1018-N 462 (veličina skale 100 mikrona), kat. br. 6

Fig.199 Photomicrograph of the lithic greywacke (N=). Sample: SU 1018-F 462 (size of the scale 100 microns), Cat. No. 6

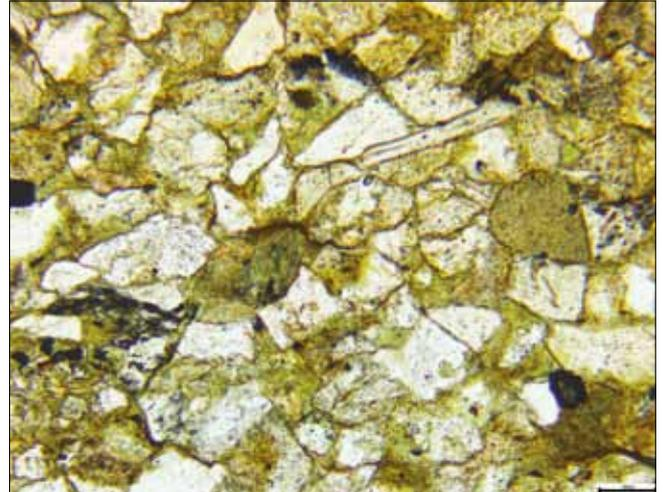

Sl. 200 Mikrofotografija litične grauivake (N=). Uzorak: SJ 1776-N 706 (veličina skale 100 mikrona), kat. br. 2

Fig.200 Photomicrograph of the lithic greywacke (N =). Sample: SU 1776-F 706 (size of the scale 100 microns), Cat. No. 2

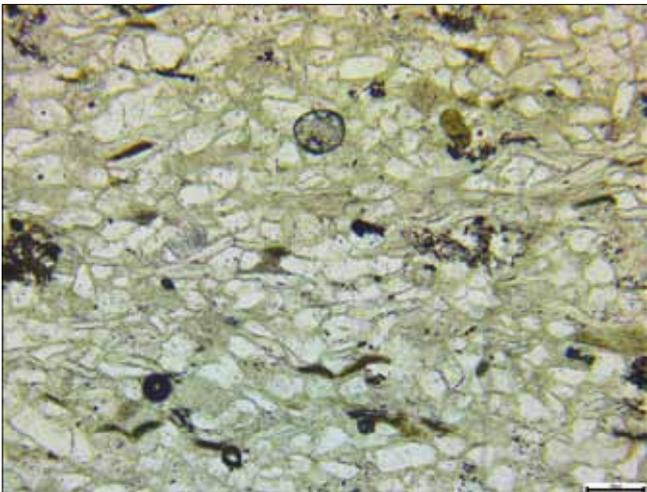

Sl. 201 Mikrofotografija litične metagreuivake (N=). Uzorak: SJ 954-N 824 (skala veličine 100 mikrona), kat. br. 1

Fig.201 Photomicrograph of the lithic metagreywacke (N =). Sample: SU 954-F 824 (size of the scale 100 microns), Cat. No. 1

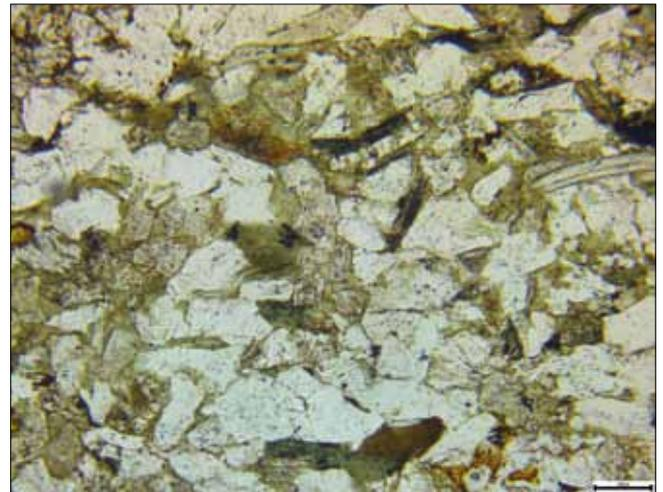

Sl. 202 Mikrofotografija litičnog arenita (N=). Uzorak: SJ 504-N 171 (skala veličine 100 mikrona), kat. br. 5

Fig.202 Photomicrograph of the lithic arenite (N =). Sample: SU 504-F 171 (size of the scale 100 microns), Cat. No. 5

264

1 Sljedeći korak u istraživanju podrijetla materijala za ove artefakte bio bi terenski obilazak potencijalnih lokaliteta (prema geološkoj karti) i uzimanje uzoraka za petrografsku analizu. Radi diskriminantne analize, uz petrografsku analizu, bilo bi potrebno načiniti i geokemijsku analizu, kako uzoraka artefakata tako i uzoraka s terena.

1 The next step in investigating the origin of materials used for these artifacts would be a field survey of potential sites (according to the geological map) and sampling for petrographic analysis. For discriminant analysis, along with petrographic analysis, a geochemical analysis would be necessary, on samples from artifacts as well as on specimens from the site.

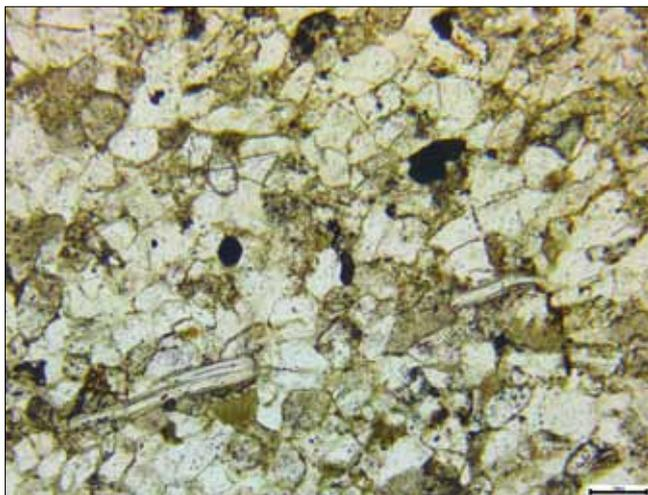

Sl. 203 Mikrofotografija sublitoarenita (N=). Uzorak: SJ 424-N 282 (veličina skale 100 mikrona), kat. br. 3

Fig. 203 Photomicrograph of the sublitharenite (N =). Sample: SU 424-F 282 (size of the scale 100 microns), Cat. No. 3

### Žrvnjevi

Pronađeni su ulomci dva rotacijska žrvnja. Jedan je ulomak izrađen od vulkanske stijene (Ulomak SJ 425-N 319, kat. br. 1, T. 7: 6, sl. 205), koja je određena kao ofitni, mandulasti metabazalt. Drugi ulomak (SJ 802-N 451, kat. br. 2, T. 17: 20, sl. 206) je klastična sedimentna stijena koja pripada grupi siliciklastičnih pješčenjaka arenitnog tipa. Petrografski ta je stijena određena kao sublitoarenit sa sadržajem kvarcnih zrna od preko 80%.

Žrvanj kat. br. 1 (T. 7: 6, sl. 205) je pripadao kružnim žrvnjevima kupolastog presjeka (De Vos et al. 2011: 134), a izrađen je od vulkanske stijene, determinirane kao ofitni mandulasti metabazalt. Žrvanj je pronađen u cjelini datiranoj <sup>14</sup>C datumom i novcem u prvu polovinu 3. st.

Ofitni mandulasti metabazalt (kat. br. 1, sl. 205) ima šupljikavu teksturu koja je nastala isplinjavanjem tijekom izlivanja vruće lave u vodenu sredinu (mandule). Naknadno su te šupljine bile ispunjene kalcitom i smečkastim glinovito-prahovitim sedimentom, koji se na površini stijene lako troše te ostaju prazne šupljinice različitih oblika. Te šupljine su pogodne za zadržavanje zrna žita i njihovo lakše mljevenje kada se gornji i donji dio žrvnja tare jedan o drugi.

Što se opisane vulkanske stijene tiče, s velikom se sigurnošću može tvrditi da ona ne potječe s teritorija R. Hrvatske, jer stijene takvih petrografskih obilježja ne nalazimo otkrivene na površini u neposrednoj, a niti u široj okolini arheološkog nalazišta.

Drugi žrvanj kat. br. 2 (T. 17: 20, sl. 206) pripadao je tipu bikonkavnih žrvnjeva, a s gornje strane nalaze se paralelni urezi koji su olakšavali drobljenje žita i curenje, odnosno sakupljanje brašna. Pronađen je u cjelini datiranoj <sup>14</sup>C datumom u početak 3. st. po. Kr.

Isto kao i za stijene prethodno opisanih brusova i za ulo-

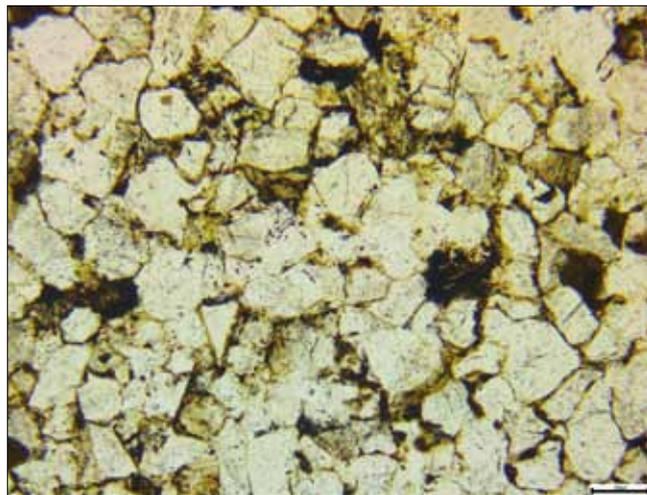

Sl. 204 Mikrofotografija kvarcnog arenita (N=). Uzorak: SJ 504-N 349 (veličina skale 100 mikrona), kat. br. 4

Fig. 204 Photomicrograph of the quartz arenite (N =). Sample: SU 504-F 349 (size of the scale 100 microns), Cat. No. 4

### Whetstones

Fragments of two rotating whetstones were found on the site. One is the fragment made of a volcanic rock (Fragment SU 425-F 319, Cat. No. 1, Pl. 7: 6, Fig. 205), which is defined as an ophitic amygdaloidal metabasalt. The second fragment (SU 802-F 451, Cat. No. 2, Pl. 17: 20, fig. 206) is a clastic sedimentary rock that belongs to a group of siliciclastic sandstones of the arenite type. This rock is petrographically defined as sublitharenite containing over 80% of quartz grains.

Whetstone Cat. No. 1 (Pl. 7: 6, fig. 205) belongs to the type of circular dome-shaped whetstones (De Vos et al. 2011: 134), and is made of a volcanic rock, defined as an ophitic amygdaloidal metabasalt. The whetstone is found in the unit dated using <sup>14</sup>C analysis and the money found in it, to the first half of the 3<sup>rd</sup> century.

Ophitic amygdaloidal metabasalt (Cat. No. 1, fig. 205) has a porous texture which is a result of degassing during the spilling of hot lava into the aquatic environment (amygdaloid). Subsequently, these cavities were filled with calcite and brownish clayish-powdered sediment, which were easily weathered from the surface of rocks, so only the empty cavities of different forms were left. These cavities are suitable for retaining the grain and allow easier grinding when the upper part of the whetstone rubs on the lower one.

As far as the described volcanic rock is concerned, it can be asserted with great confidence that it does not originate from the territory of the Republic of Croatia, because rocks of such petrographic features cannot be found on the surface in the direct vicinity, or in the wider area of the archaeological site.

The other whetstone, Cat. No. 2 (Pl. 17: 20, fig. 206), belonged to the type of biconcave whetstones, and it had parallel cuts on the upper side which facilitated the crushing of grain and leaking, that is the collecting of flour.

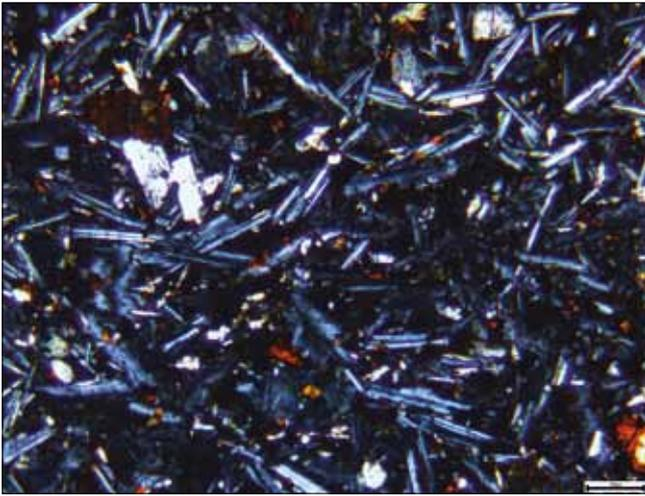

Sl. 205 Mikrofotografija ofitnog metabazalta (N+). Uzorak: SJ 425-N 319 (skala veličine 100 mikrona), kat. br. 1

Fig. 205 Photomicrography of the ophitic metabasalt (N+). Sample: SU 425-F 319 (size of the scale 100 microns), Cat. No. 1

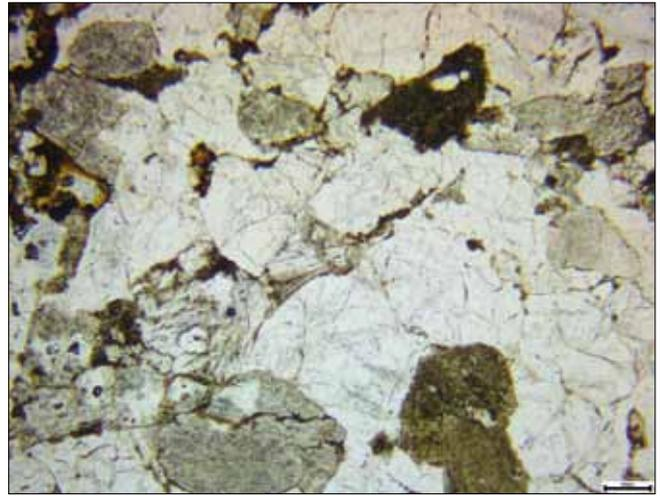

Sl. 206 Mikrofotografija sublitoarenita (N=). Uzorak: SJ 802-N 451 (veličina skale 200 mikrona), kat. br. 2

Fig. 206 Photomicrograph of the sublithoarenite (N=). Sample: SU 802-N 451 (size scale 200 microns), Cat. No. 2

mak žrvnja izrađenog od pješčenjaka postoji mogućnost njegovog nalaza na Papuku, ali isto tako i na obližnjem Meczeku u Mađarskoj. Međutim, nije isključen ni transport tog kamenja i s udaljenijih lokaliteta.

266

Kamenolomi za žrvnjeve specifični su i razlikuju se od kamenoloma u kojima se bere kamen za druge svrhe. Žrvnjevi su bili od određene vrste kamena, a kamen za žrvnjeve brao se na način koji je ostavljao specifične tragove negativna žrvnjeva. Sama problematika kamenoloma za žrvnjeve nije toliko dobro istražena i istražen je samo manji broj kamenoloma (manje od 20) (Belmont 2011: 5–6, 10). Budući da su izrađivani od posebne vrste kamena, često su predmet trgovine na veće udaljenosti (Anatonelli, Lazzarini 2010: 2091; Gluhak, Hofmeister 2009: 1614–1618).

Analiza arheobotaničkih ostataka (vidi poglavlje 5.2) ukazala je na prisutnost žitarica na lokalitetu i to na način da su očišćene i pripremljene za korištenje u prehrani. Prisutnost žrvnjeva uz pronađene žitarice, govori ujedno o izradi brašna na lokalitetu.

### Predmeti od rožnjaka

Na lokalitetu je pronađeno sječivo, dva odbojka i jezgra. Izrađeni su od rožnjaka. Na lokalitetu nisu pronađeni prapovijesni nalazi te je teško interpretirati pojavu ovih kamenih nalaza koji su svojim odlikama karakteristični za prapovijest. Kremen se u antici koristio zajedno s kresivima za paljenje vatre, ali i u gradnji. Na lokalitetu nije pronađen nijedan primjerak kresiva, a kremen koji je korišten za potpalu bio bi znatno veći. Kontekst je nejasan budući da je pronađen u stupovima bez nekih drugih nalaza. Više je puta naglašena prapovijesna tradicija na lokalitetu koja je iskazljiva u različitom keramičkom materijalu i načinu stanovanja. Nedostatak objava lokaliteta sličnih Virovitici

It was found in an unit dated using  $^{14}\text{C}$  analysis to the beginning of the 3<sup>rd</sup> century.

As well as the rocks of previously described grindstones, sandstone of which the fragment of whetstone was made of may also be found on Papuk, and on the nearby Meczek in Hungary. However, the transport of these stones from more distant localities may not be excluded.

Quarries from which the stone for whetstones was acquired are specific and differ from quarries where stone was obtained for other purposes. Whetstones were made of a certain type of stone, and that stone was excavated in a way that left a specific trace of the whetstone in the negative. The problem of quarries for whetstones has not been well researched and only a small number of such quarries was explored (less than 20) (Belmont 2011: 5–6, 10). Since whetstones were made out of a special type of stone, they were often traded over longer distances (Anatonelli, Lazzarini 2010: 2091; Gluhak, Hofmeister 2009: 1614–1618).

The analysis of archaeobotanical remains (see section 5.2) indicated the presence of grains at the site in such a way that they have been cleaned and prepared for use in meals. The presence of whetstones and cereals in the same site also indicates production of flour at the site.

### Items made of chert

A blade, two flakes and a core were found on the site. They were made of chert. There were no prehistoric findings on the site so it is difficult to interpret the appearance of these stone findings that are by their properties characteristic for prehistory. Quartz was, during Antiquity, used along with tinder for lighting fires, but also for the construction. Not one sample of flint was found on the site and flints used for firing would be significantly larger. The context is unclear since quartz was found postholes without any other findings. Prehistoric tradition at the site was repeatedly emphasized and it is apparent in a different ceramic material and the method of housing. Lack of



Kiškoriji jug otežava interpretaciju ovakvih nalaza budući da smo zakinuti za podatak je li ovo izolirana pojava.

Kao što se iz prethodnih poglavlja moglo zaključiti, ekonomija sela je bila usmjerena na samodostatnost, a kupovina dobara koji nisu bili dostupni u neposrednoj sredini je svedena na minimum. Bez definiranja izvorišta i porijekla stijena od kojih su izrađeni kameni nalazi s *Virovitice Kiškorije jug*, za sada ne možemo biti sigurni o kojim je trgovačkim kontaktima riječ.

## KATALOG KAMENIH NALAZA

### Brusovi

1. Ulomak kamenog brusa (T. 18: 6, sl. 201).  
Dim: 5 x 4,5x1,8 cm  
SJ 954; □ (J 33); S – XV; N – 524
2. Ulomak kamenog brusa. Jedna je strana predmeta sedlasto oblikovana, zbog učestale upotrebe predmeta (T. 21: 1a–1b, sl. 200).  
Dim: 10,5 x 5,2x3,1 cm  
SJ 1776; □ (F 15); S – XIX; N – 706
3. Ulomak kamenog brusa. Jedna je strana predmeta sedlasto oblikovana, zbog učestale upotrebe predmeta (T. 27: 5a–5b, sl. 203).  
Dim: 6 x 3,6 x 3,5 cm  
SJ 424; □ U 25/26, V 25; S – VII; N – 282
4. Ulomak kamenog brusa (T. 27: 8a–8b, sl. 204).  
Dim: 5,6 x 4,7 x 2,3 cm  
SJ 504; □ H/I 6/7, I 6; S – XII; N – 349
5. Ulomak kamenog brusa. Jedna je strana predmeta sedlasto oblikovana, vjerojatno zbog učestale upotrebe predmeta (T. 27: 9, sl. 202).  
Dim: 5,5 x 4x 1,7x 2,5 cm  
SJ 504; □ H/I 6/7, I 6; S – XII; N – 171
6. Ulomak kamenog brusa (T. 28: 8, sl. 199).  
Dim: 12 x 5,6 x 2,1 cm  
SJ 1018; □ (J 24); S – XVII; N – 462

### Žrvnjevi

1. Ulomak kamenog žrvnja. Donji dio je ravan i zaglađen od upotrebe, bočna stranica je blago zaobljena, gornja se prema sredini zadebljava. Oštećen je u središnjem dijelu radi čega nedostaje potpuni presjek (T. 7: 6, sl. 205).  
Dim: 11 x 9 x 7 x 9 cm  
SJ 425; □ V 28; S – VI; N – 319
2. Ulomak kamenog žrvnja. Jedna strana je ravna, a druga

publication of sites like Virovitica Kiškorija south complicates the interpretation of these findings since we are missing the data on whether this is an isolated phenomenon.

As could be concluded from the previous sections, the economy of the village was focused on self-sufficiency, and the purchase of goods that were not available in the immediate surrounding was minimal. Without defining the source and origin of rocks of which the stone finds from *Virovitica Kiškorija south* site were made, we cannot, for the time being, be sure of the commercial contacts.

## CATALOGUE OF STONE FINDS

### Grindstones

1. Fragment of a grindstone (Pl. 18: 6, fig. 201).  
Dim: 5 x 4.5 x 1.8 cm  
SU 954; □ (J 33); A – XV; F – 524
2. Fragment of a grindstone. One side of the object is saddle shaped, due to frequent use (Pl. 21: 1a–1b, fig. 200).  
Dim: 10.5 x 5.2 x 3.1 cm  
SU 1776; □ (F 15); A – XIX; F – 706
3. Fragment of a grindstone. One side of the object is saddle shaped, due to frequent usage (Pl. 27: 5a–5b, fig. 203).  
Dim: 6 x 3.6 x 3.5 cm  
SU 424; □ U 25/26, V 25; A – VII; F – 282
4. Fragment of a grindstone (Pl. 27: 8a–8b, fig. 204).  
Dim: 5.6 x 4.7 x 2.3 cm  
SU 504; □ H/I 6/7, I 6; A – XII; F – 349
5. Fragment of a grindstone. One side of the object is saddle shaped, probably due to frequent usage (Pl. 27: 9, fig. 202).  
Dim: 5.5 x 4 x 1.7 x 2.5 cm  
SU 504; □ H/I 6/7, I 6; A – XII; F – 171
6. Fragment of a grindstone (Pl. 28: 8, fig. 199).  
Dim: 12 x 5.6 x 2.1 cm  
SU 1018; □ (J 24); A – XVII; F – 462

### Whetstones

1. Fragment of a whetstone. The lower part is flat and smoothed from the usage, the side wall is slightly rounded and the top thickens towards the middle. It is damaged in the central part, so the complete cross-section is not preserved (Pl. 7: 6, fig. 205).  
Dim: 11 x 9 x 7 x 9 cm  
SU 425; □ V 28; A – VI; F – 319
2. Fragment of a whetstone. One side is flat and the other



je profilirana uskim paralelnim žlijebovima (T. 17: 20, sl. 206).

Dim : 6 x 8,9 x 3 x 5,5 cm

SJ 802; □ (L-M 33); S – XIV; N – 451

### **Predmeti od rožnjaka<sup>2</sup>**

1. Sječivo (T. 15: 18).  
Dim: 2,3 x 0,8 x 0,3 cm  
SJ 626, □ G 2, S–XIV, N–373
2. Odbojak (T. 15: 19).  
Dim: 2,6 x 2,2 x 0,9 cm  
SJ 662; □ D 2; S – XIV; PN – 51
3. Reducirana bipolarna jezgra (T. 26: 10).  
Dim: 0,5 x 1,4 x 0,7 cm  
SJ 001; S – XIV; PN – 41
4. Obrađeni odbojak s retušom na ventralnoj strani (T. 28: 9)  
Dim: 3,2 x 2,4 x 0,5 cm  
SJ 1018; □ (J 23); S – XVII; PN – 39

is profiled with narrow parallel grooves (Pl. 17: 20, fig. 206).

Dim : 6 x 8.9 x 3 x 5.5 cm

SU 802; □ (L-M 33); A – XIV; F – 451

### **Items made of chert<sup>2</sup>**

- 1 Blade (Pl. 15: 18).  
Dim: 2.3 x 0.8 x 0.3 cm  
SJ 626; □ G 2; S – XIV, N – 373
- 2 Flake (Pl. 15: 19).  
Dim: 2.6 x 2.2 x 0.9 cm  
SU 662; □ D 2; A – XIV; SF – 51
- 3 Reduced bipolar core (Pl. 26: 10).  
Dim: 0.5 x 1.4 x 0.7 cm  
SU 001; A – XIV; SF – 41
- 4 Processed flake with a retouch on the ventral surface.  
(Pl. 28: 9)  
Dim: 3.2 x 2.4 x 0.5 cm  
SU 1018; □ (J 23); A – XVII; SF – 39

2 Zahvaljujem se dr. sc. Nikoli Vukosavljeviću na pomoći oko strukovnog nazivlja predmeta od rožnjaka.

2 I would like to thank Nikola Vukosavljević, Ph.D for his help with special field terminology for items made of chert.

4.7.

Table pokretne arheološke građe po cjelinama  
Tables of movable archaeological findings by units

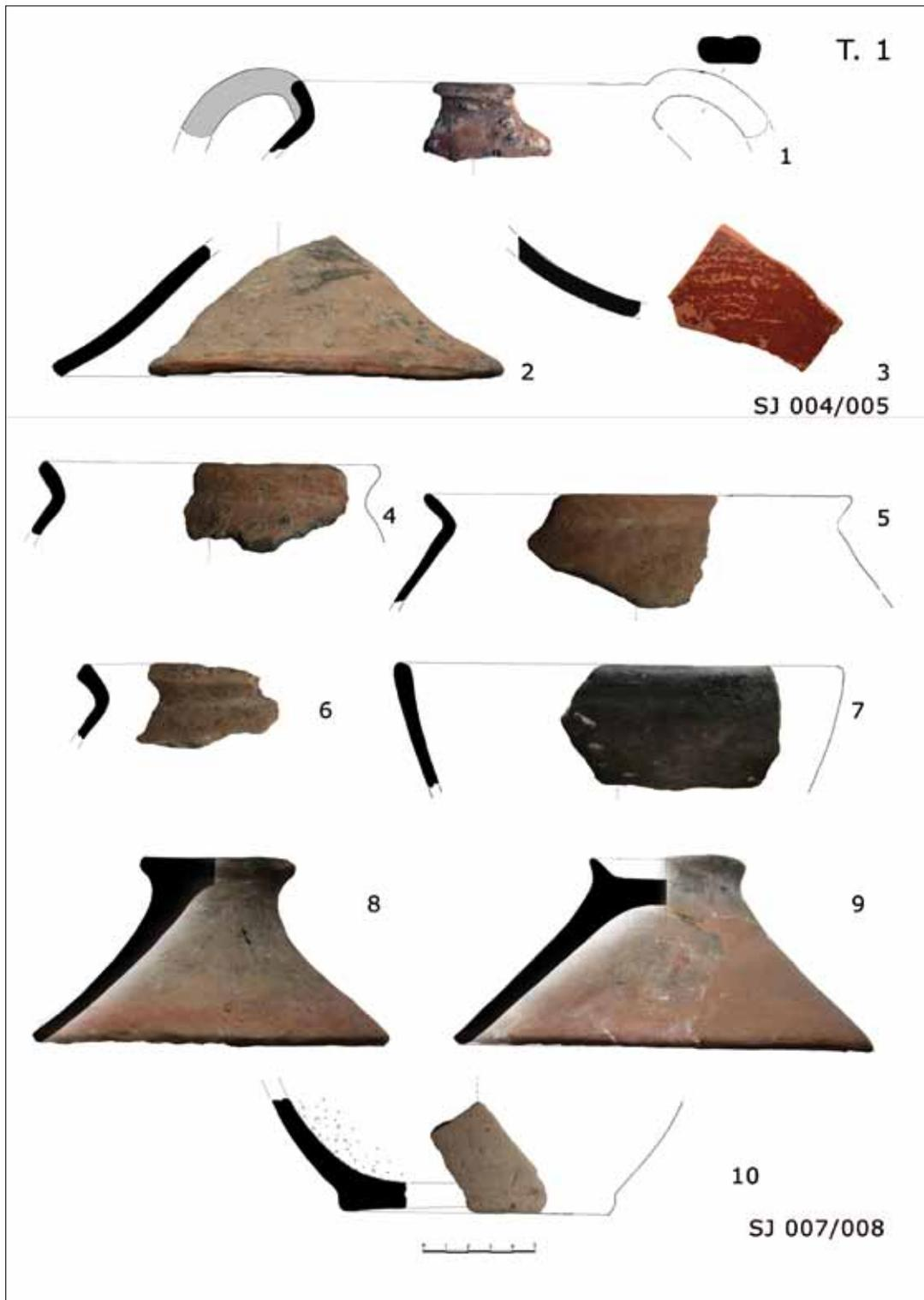

T. 2

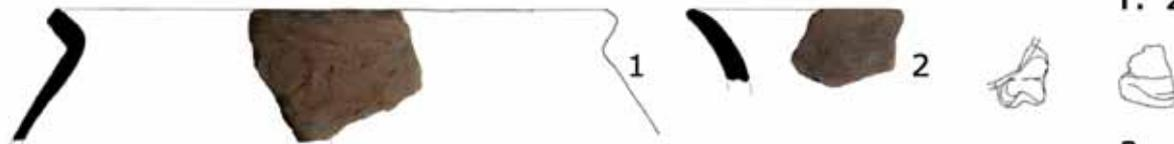

3

SJ 015/016



SJ 013/014



SJ 025/026



SJ 052/053



T. 3





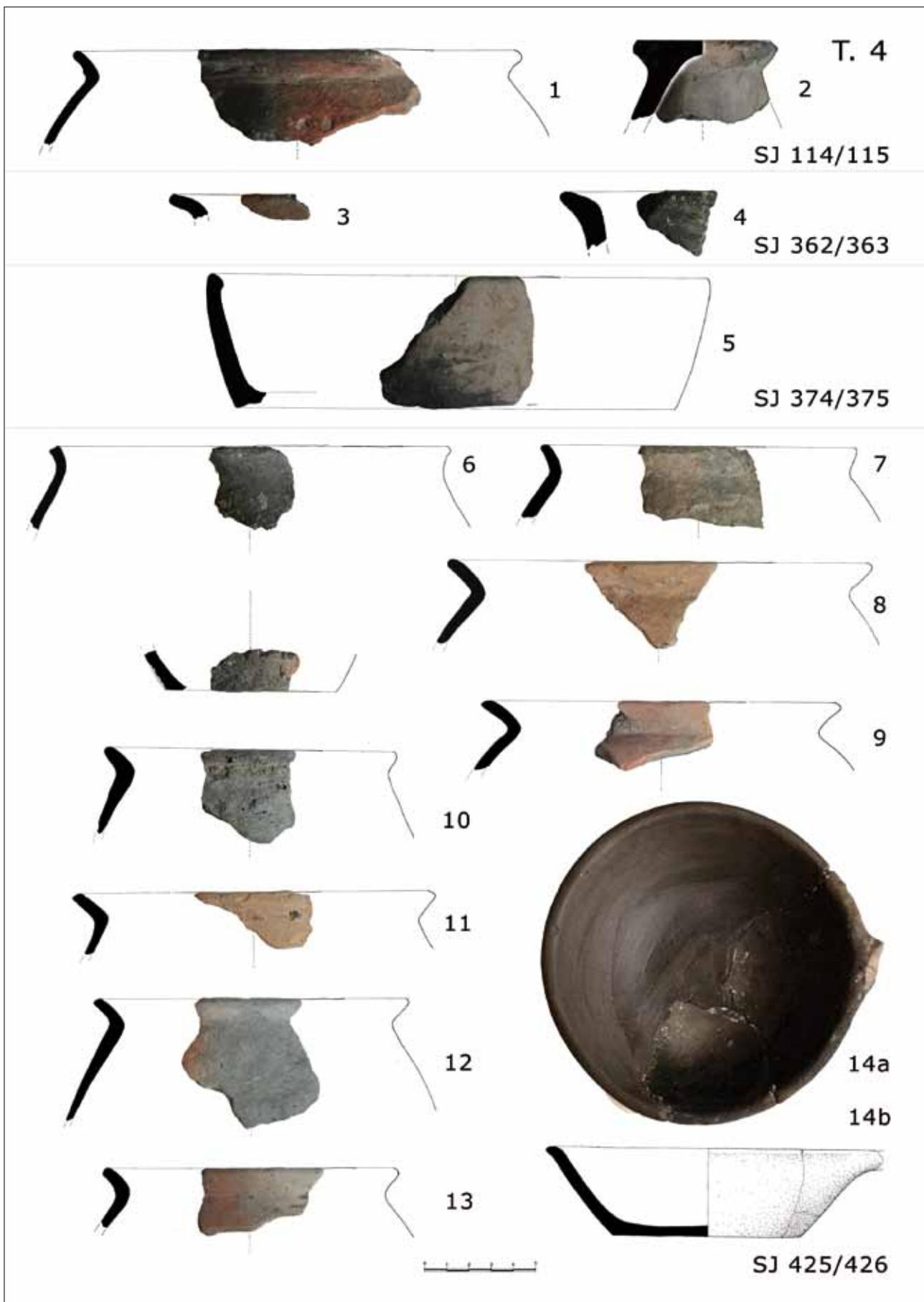

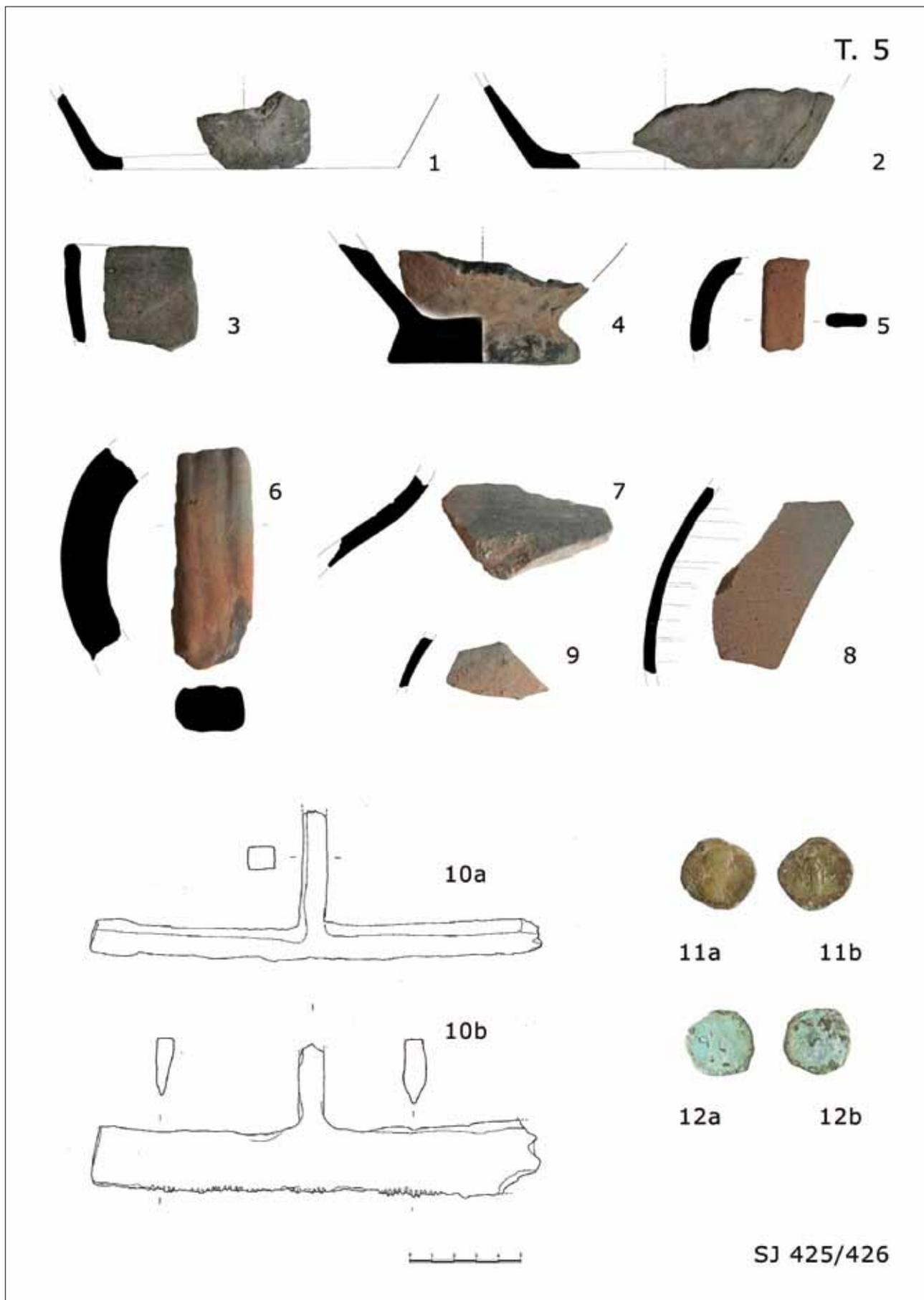

T. 6

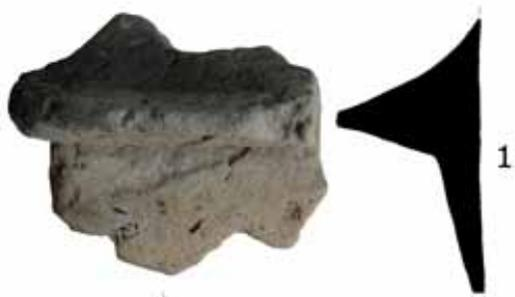

SJ 425/426

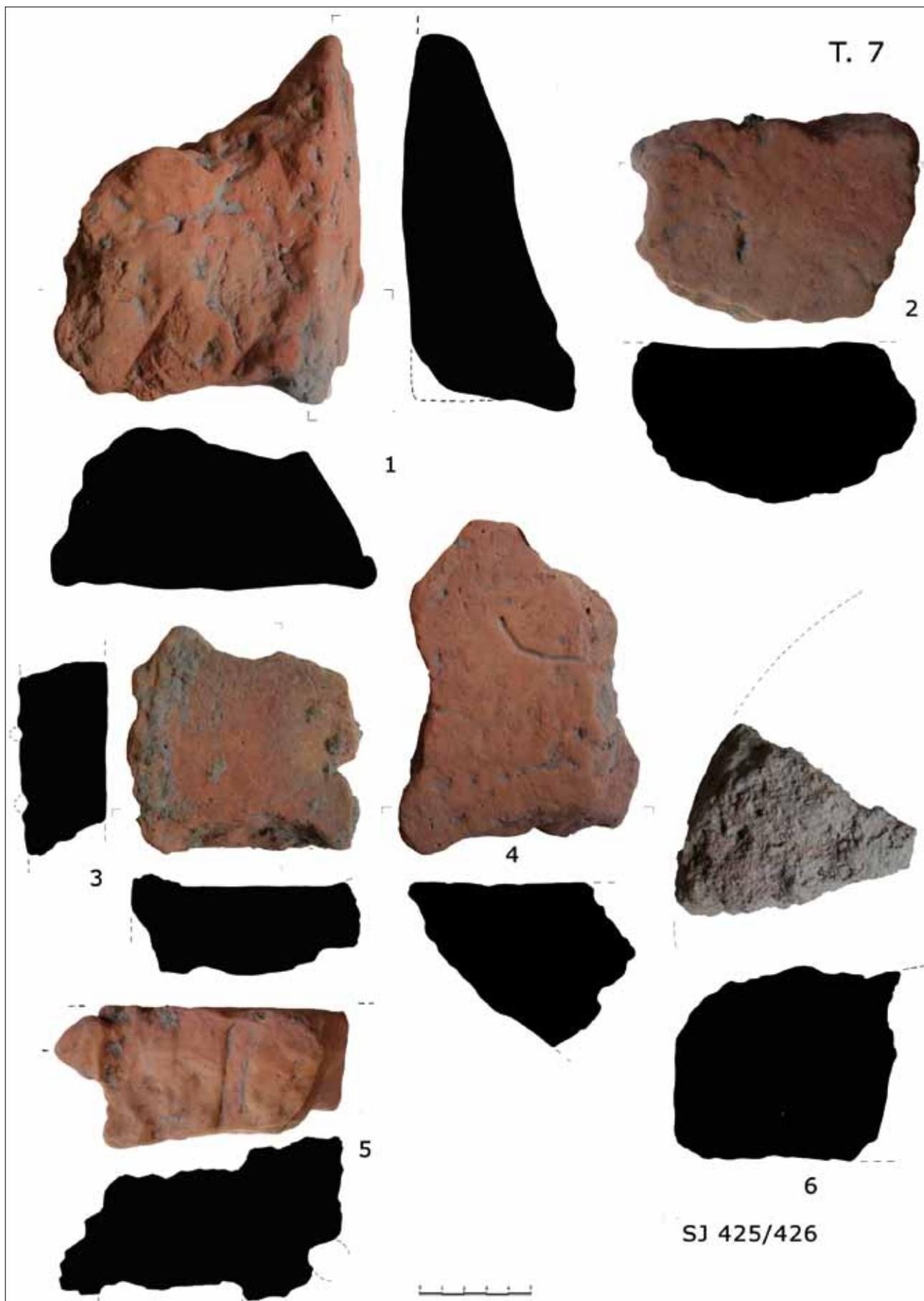

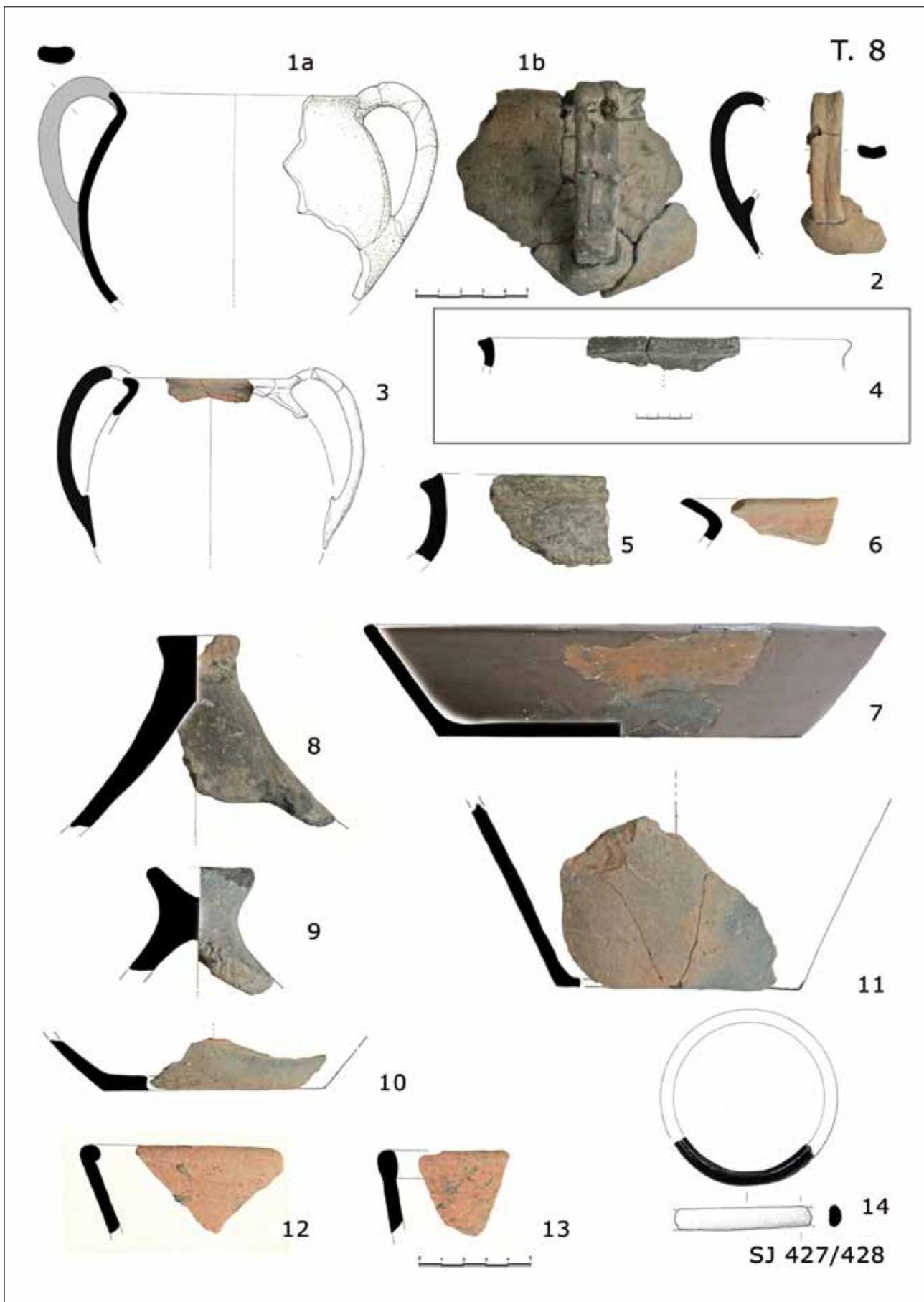

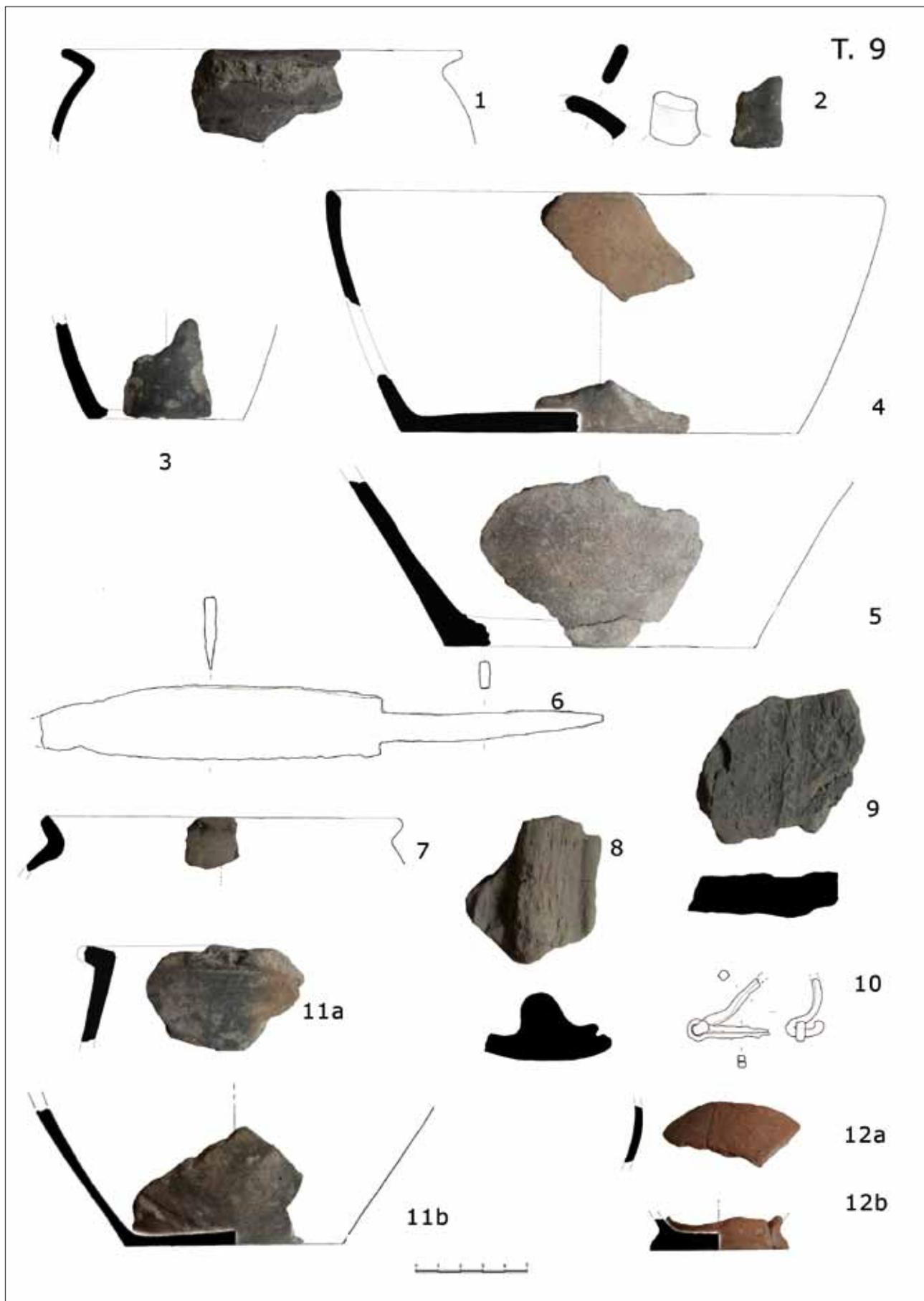

T. 10

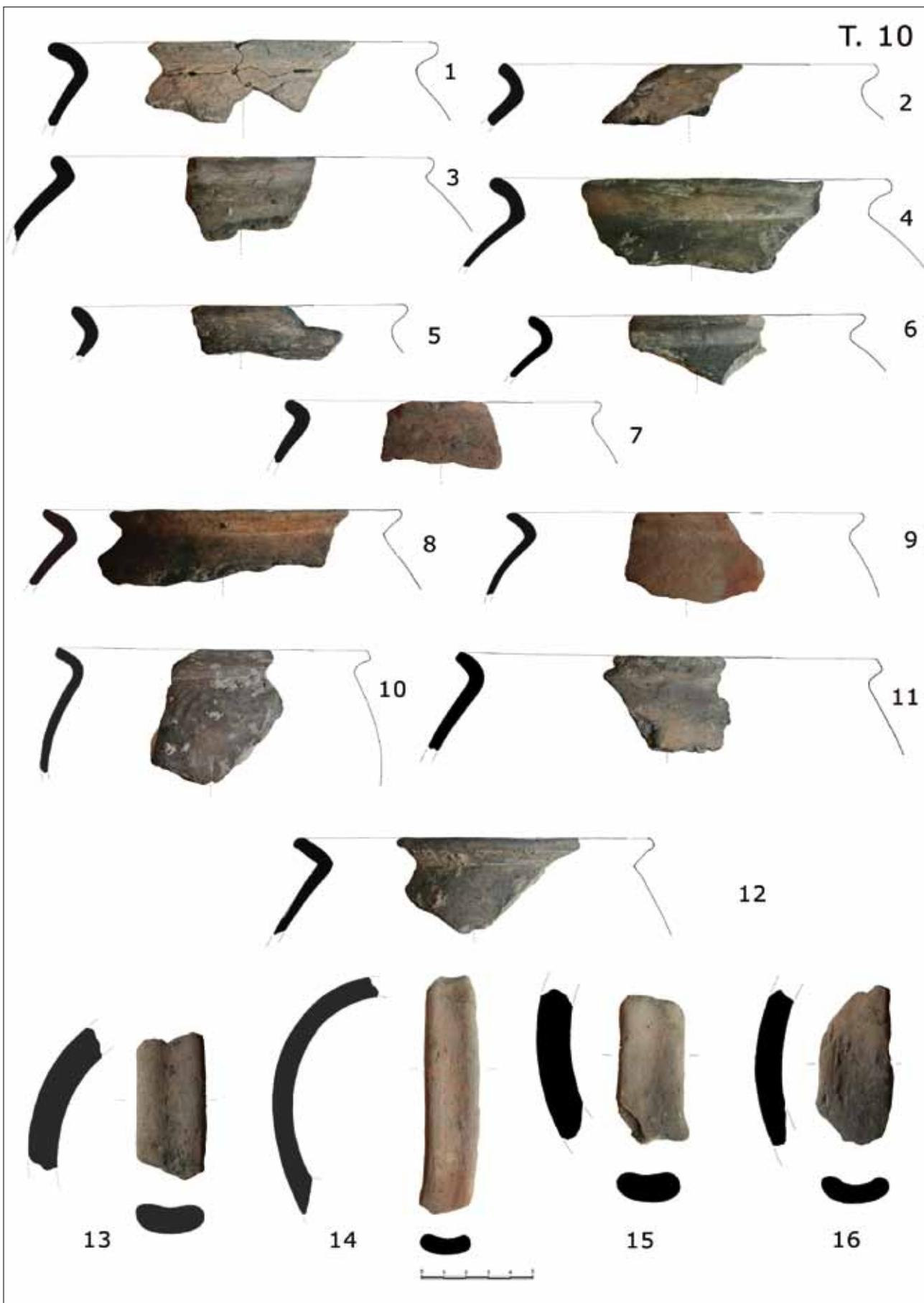

T. 11

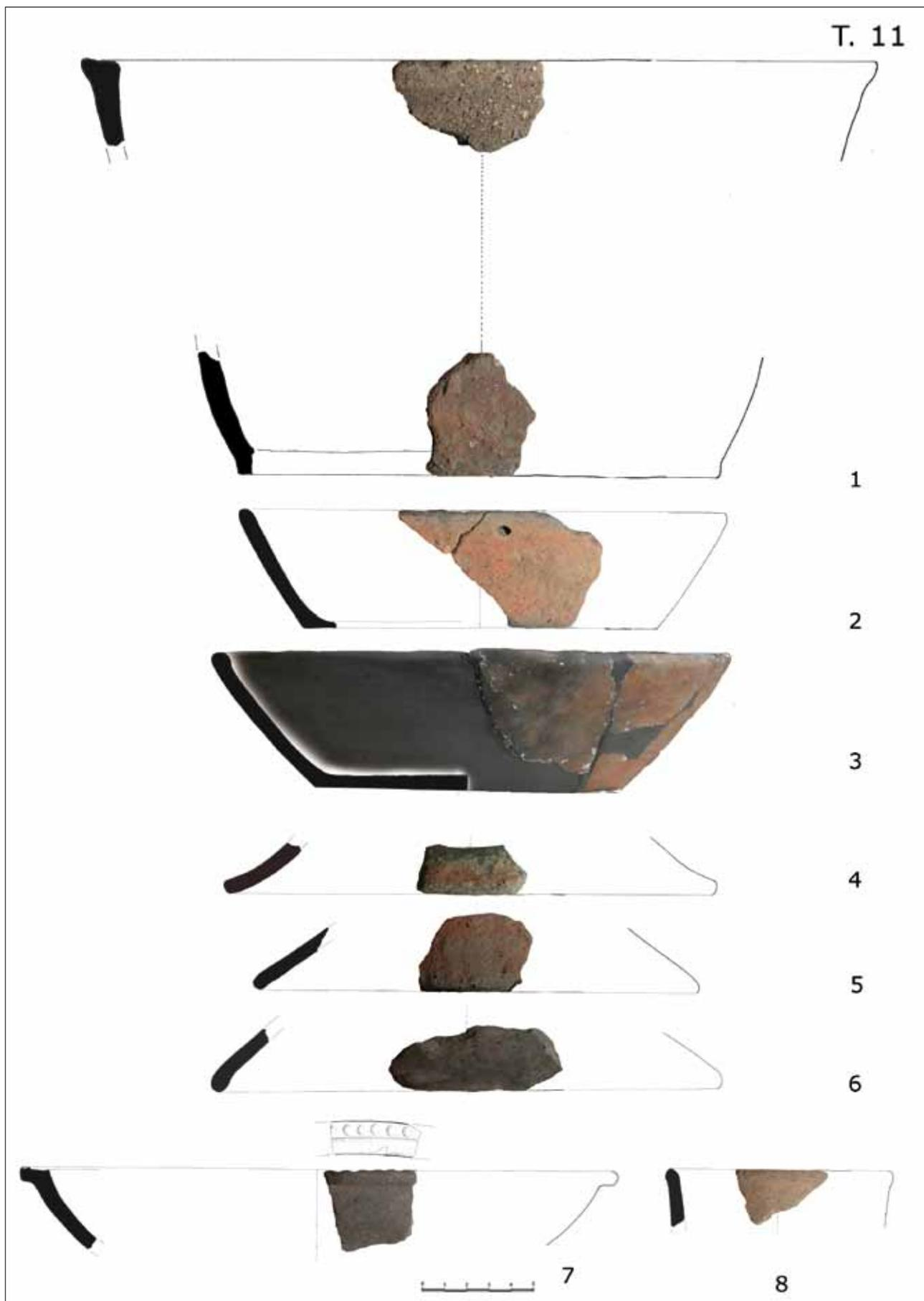



T. 12

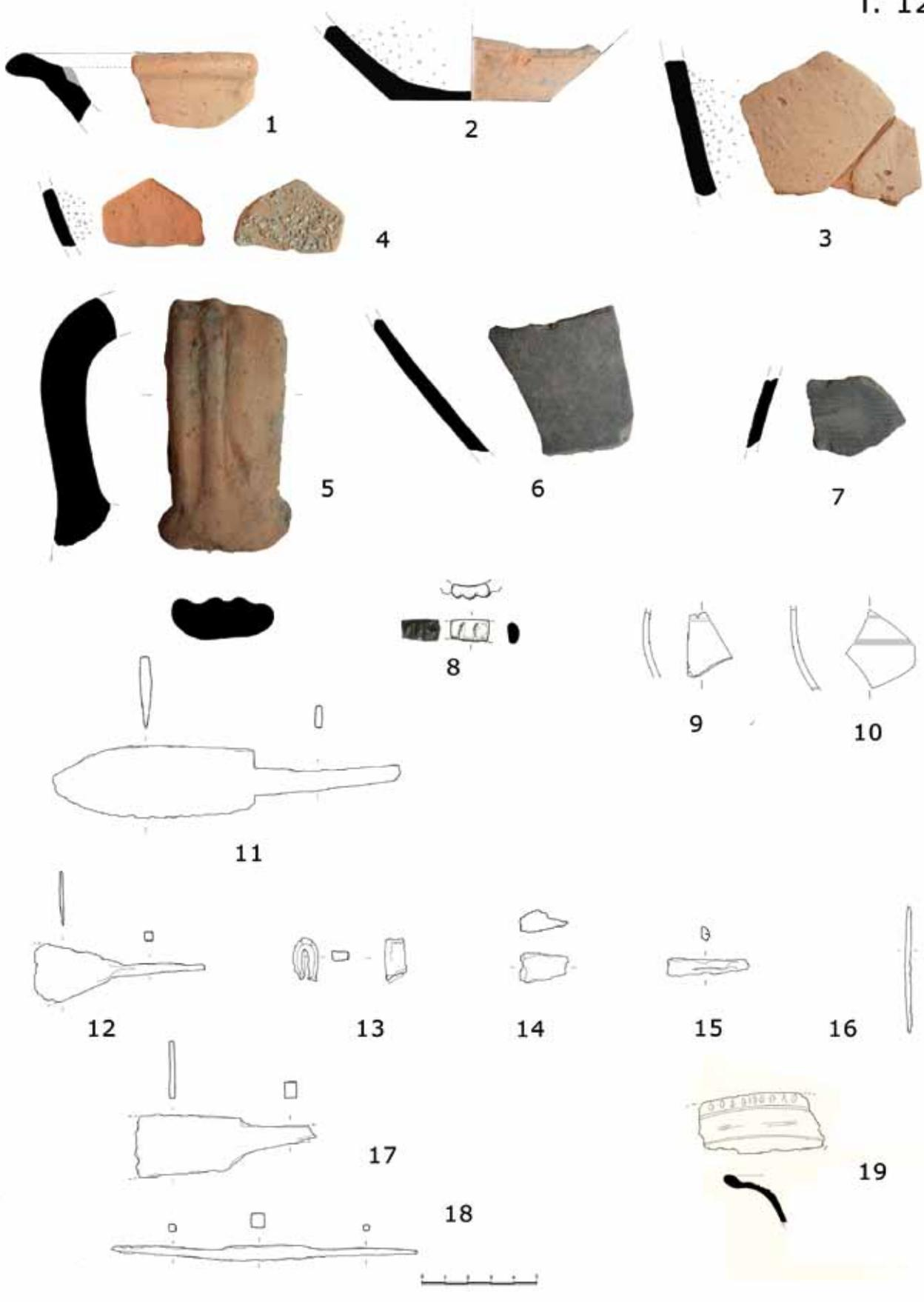

T. 13

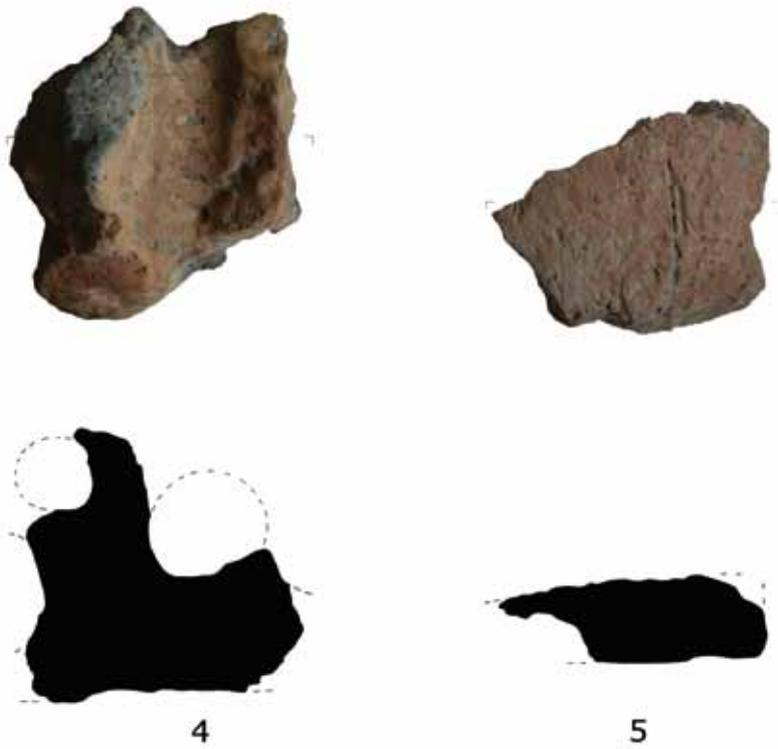
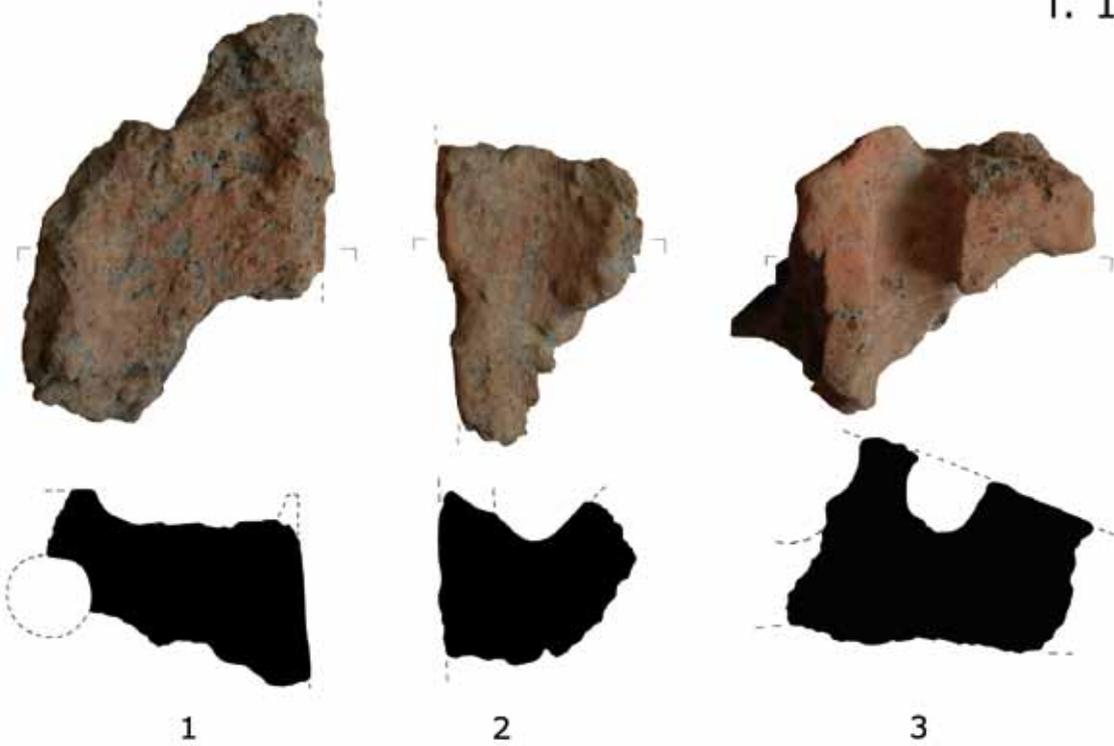

T. 14

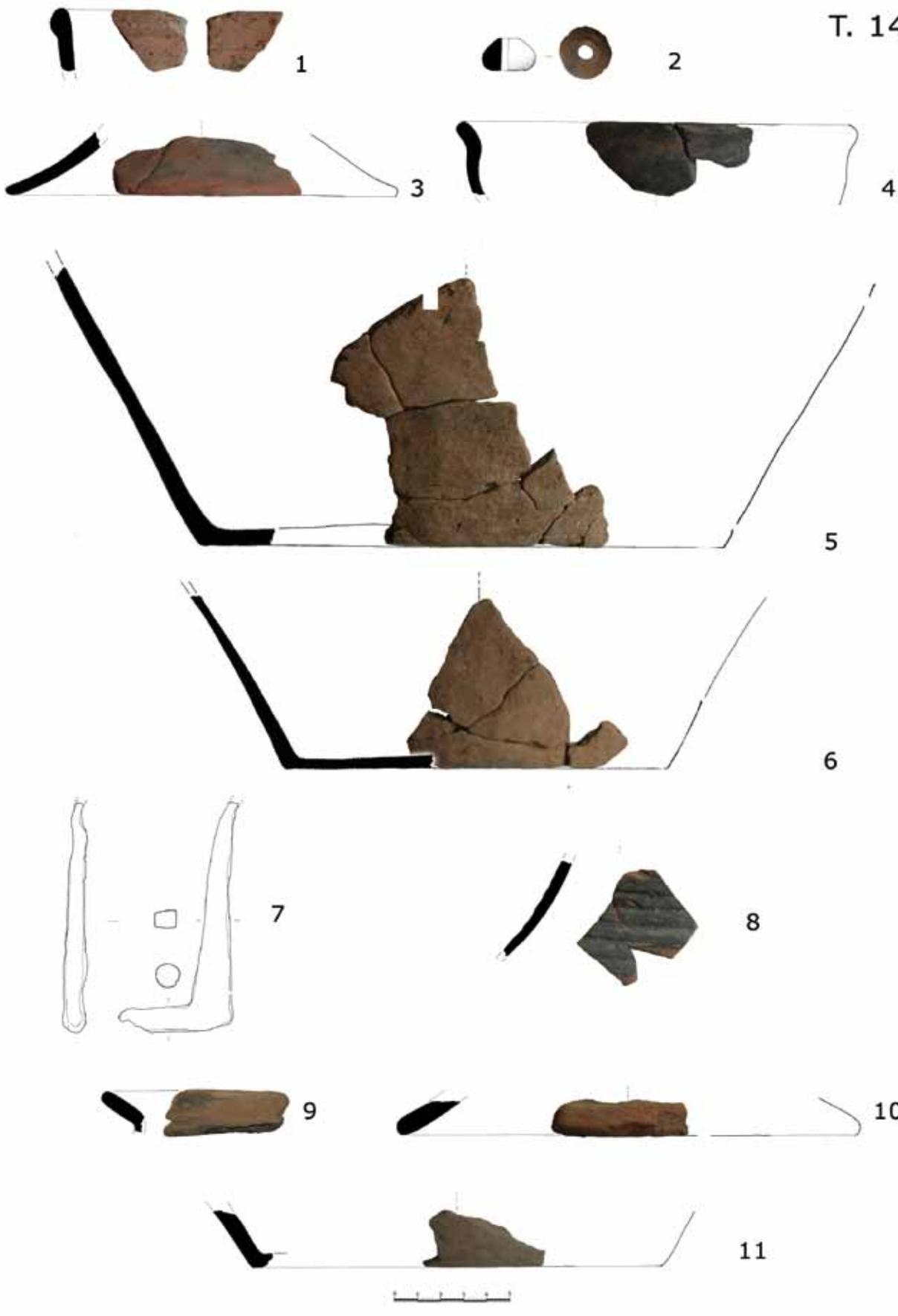

T. 15

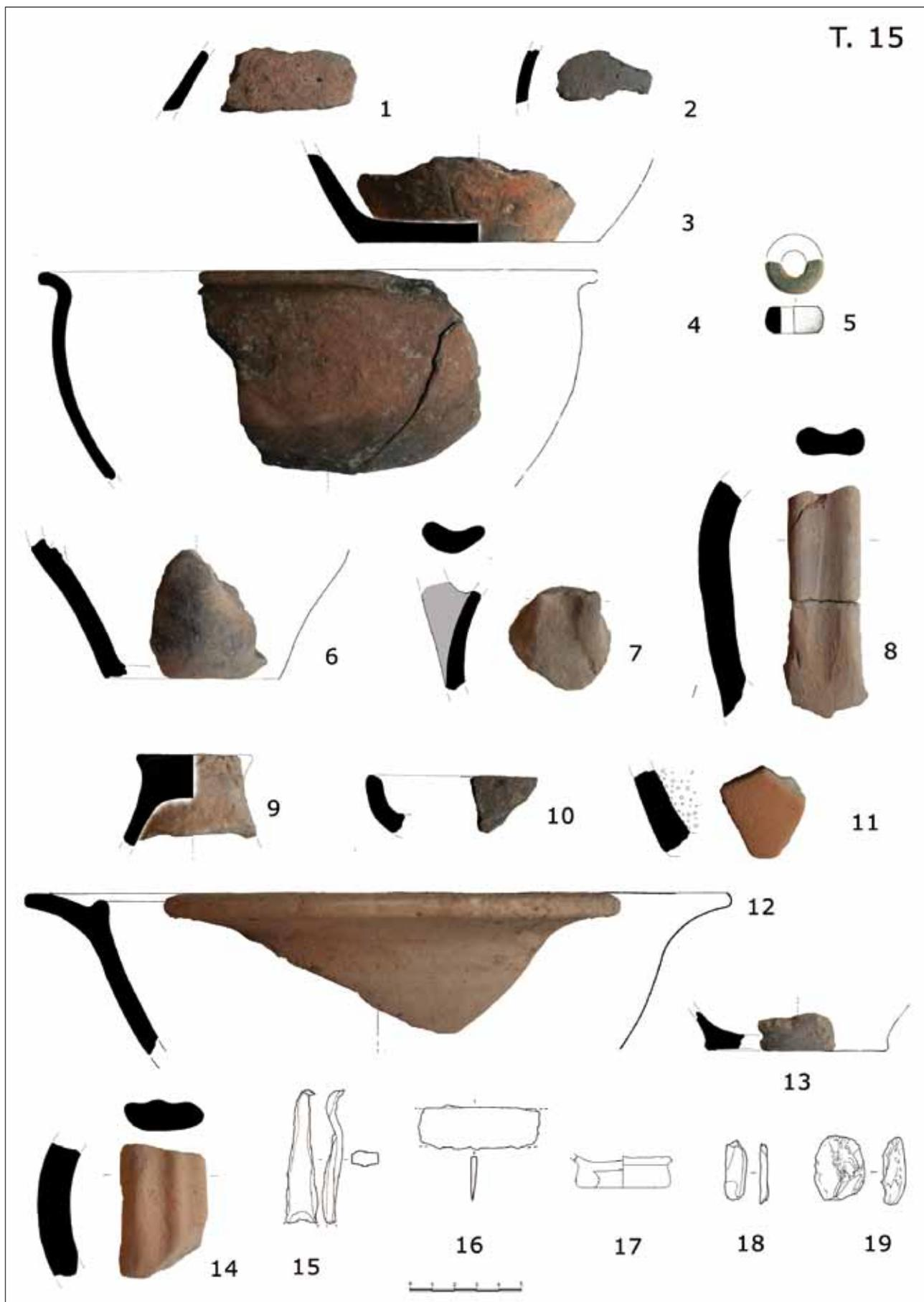

T. 16



T. 17



T. 18

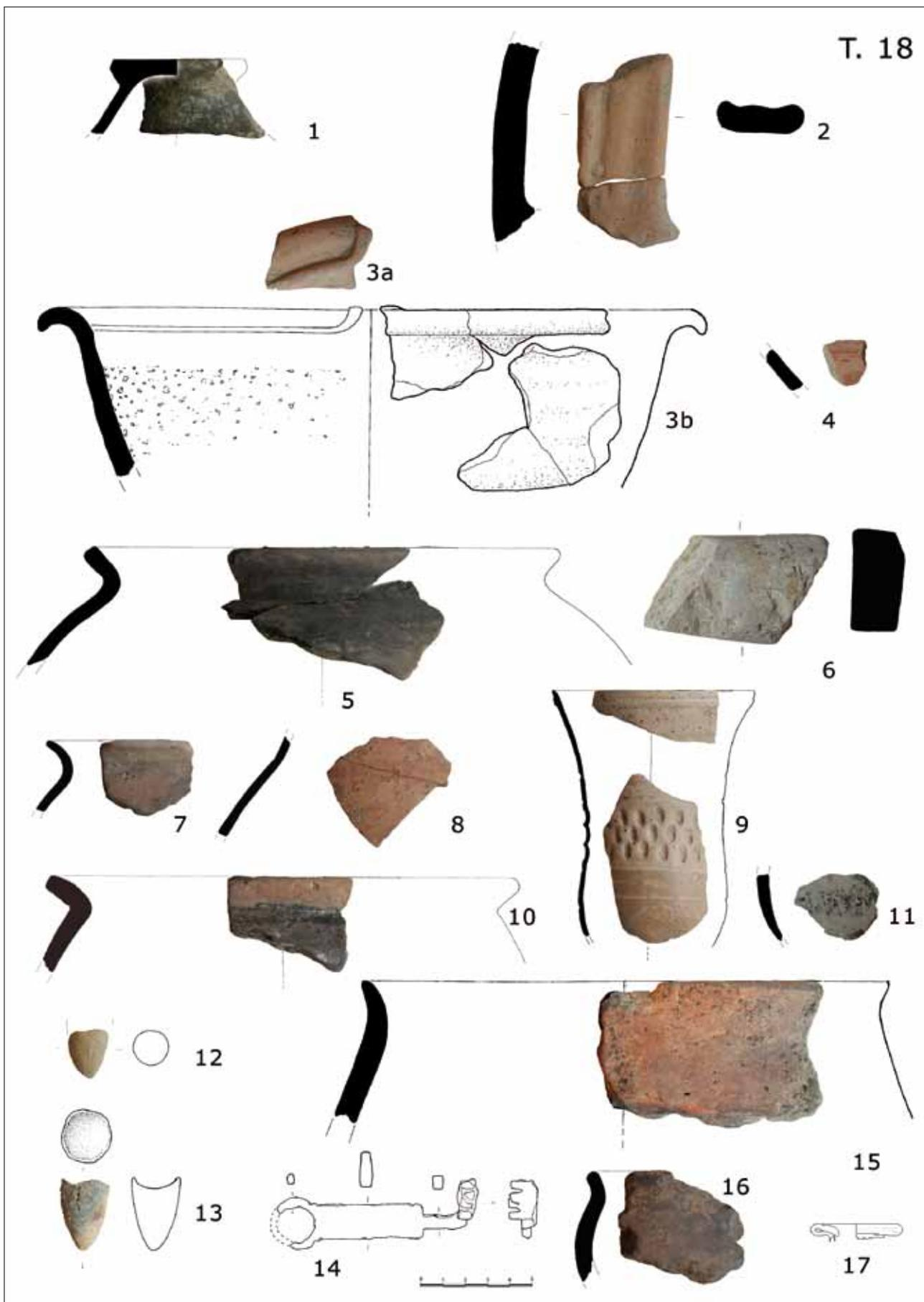

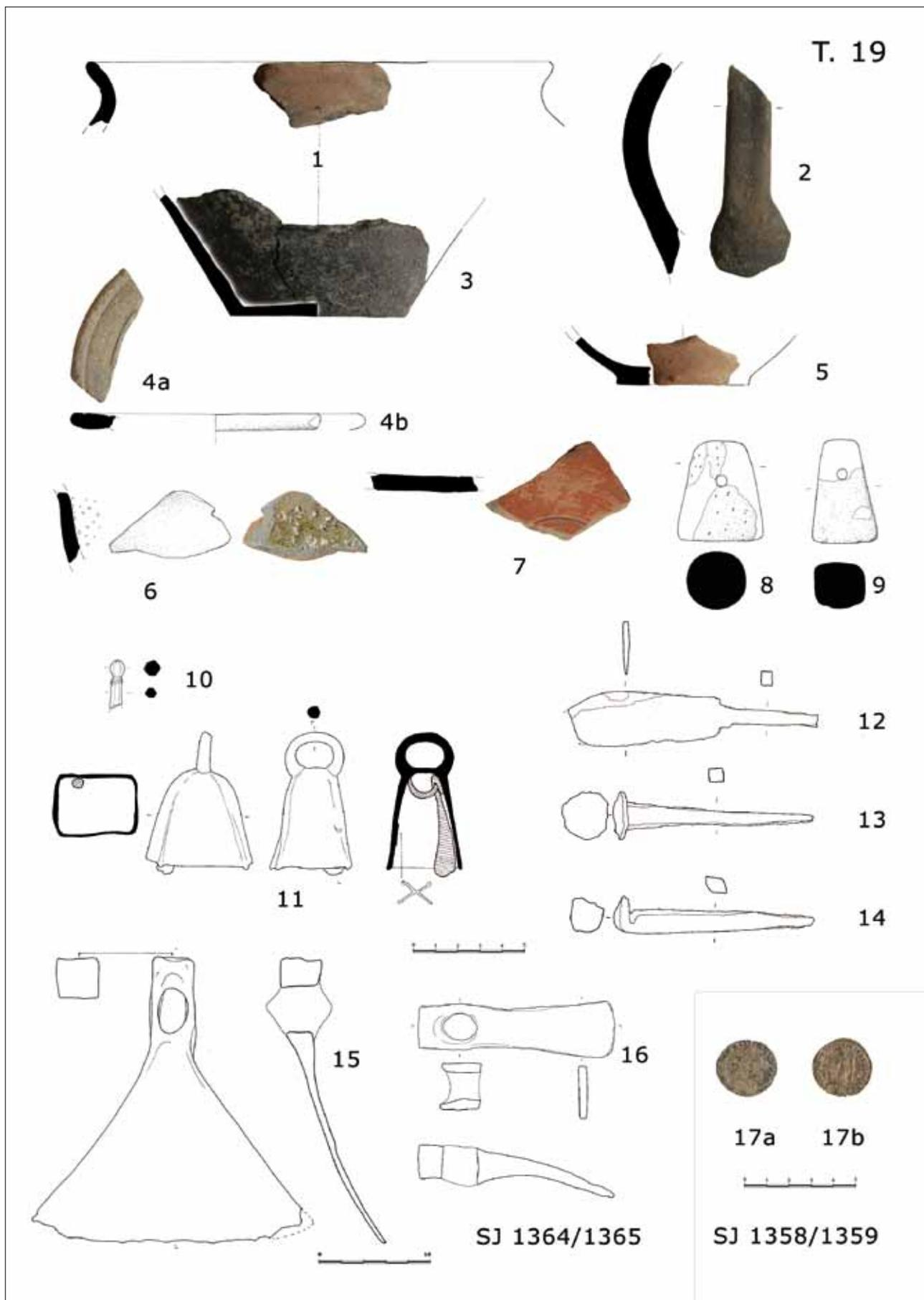



T. 20

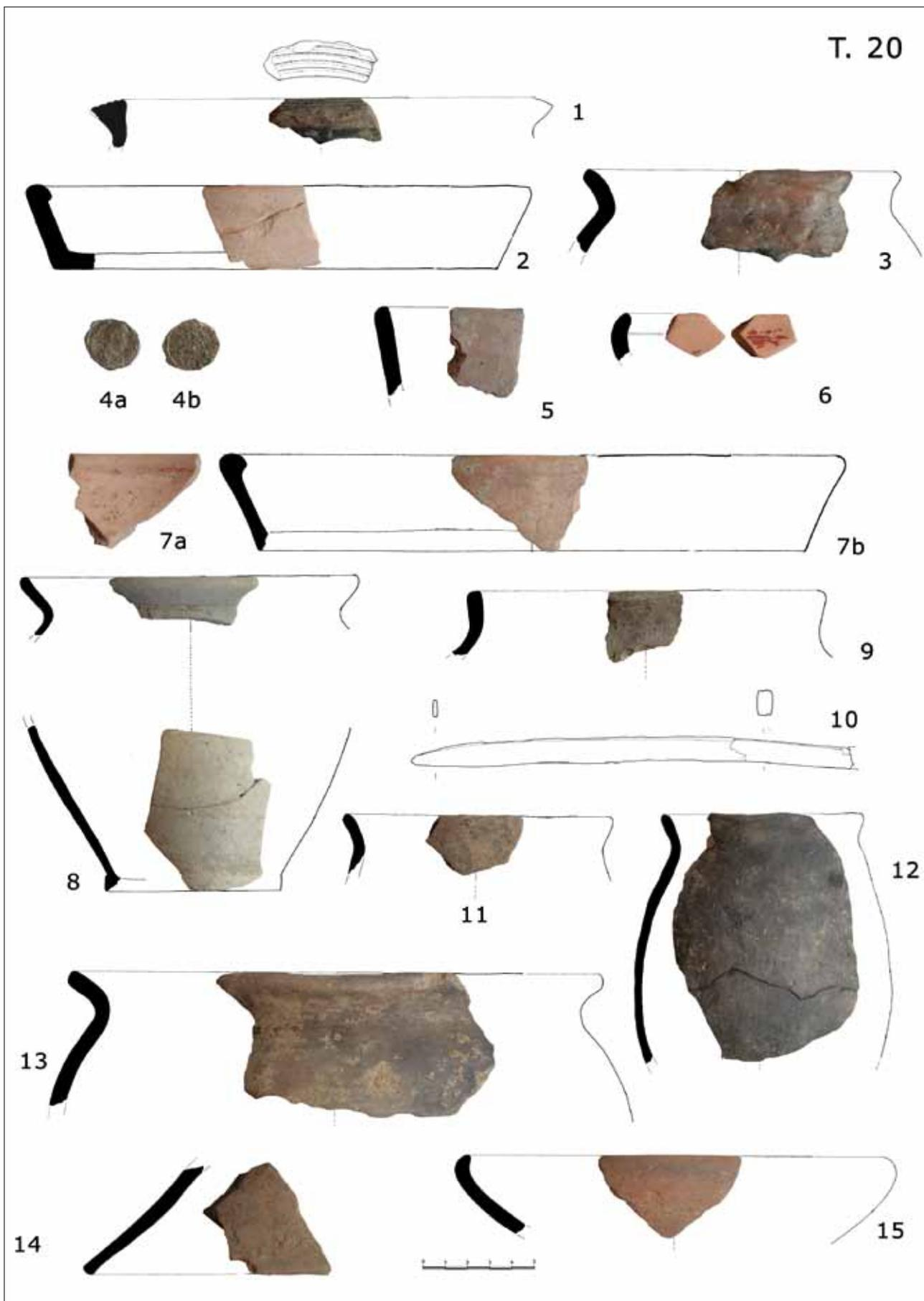

T. 21

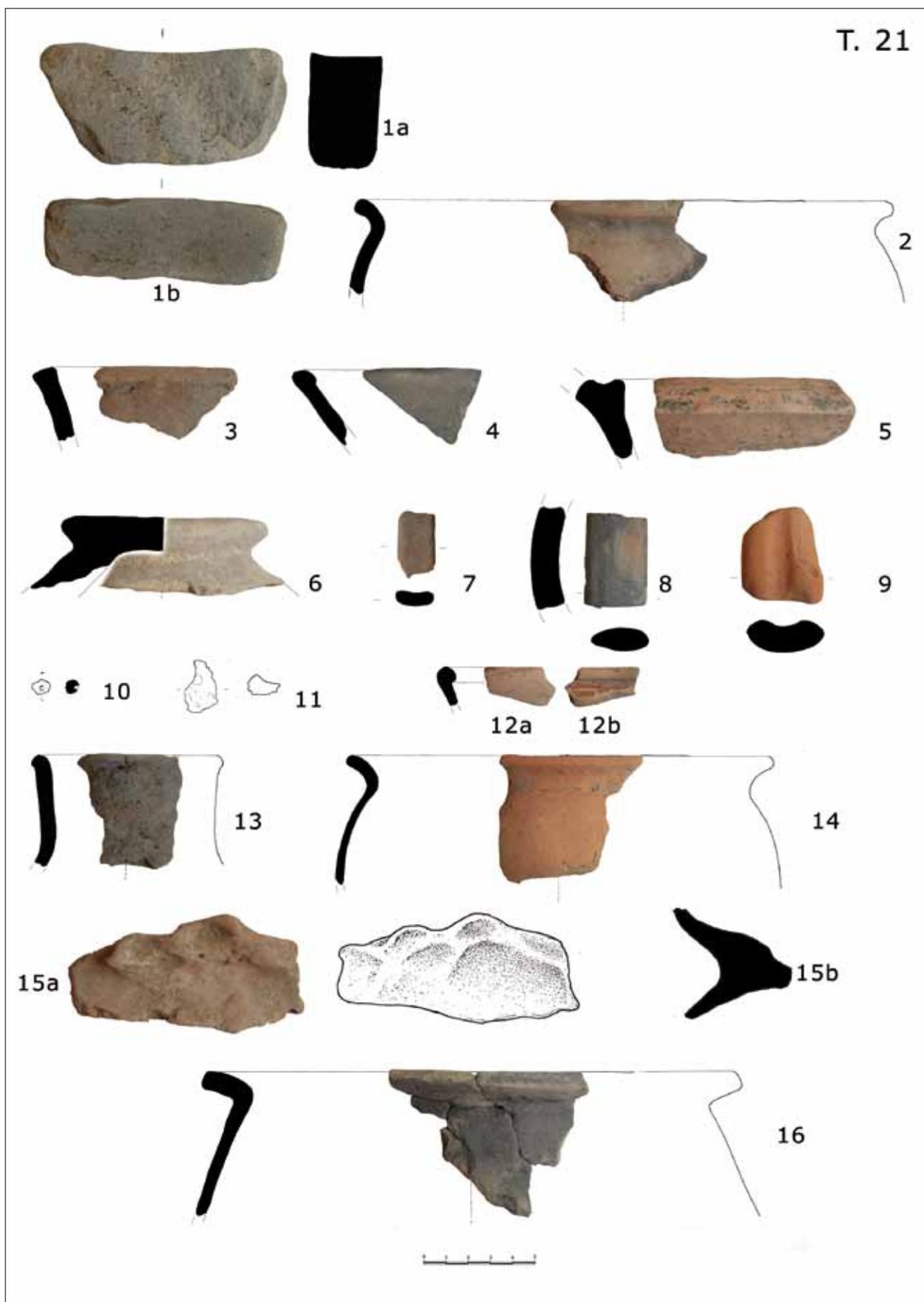

T. 22



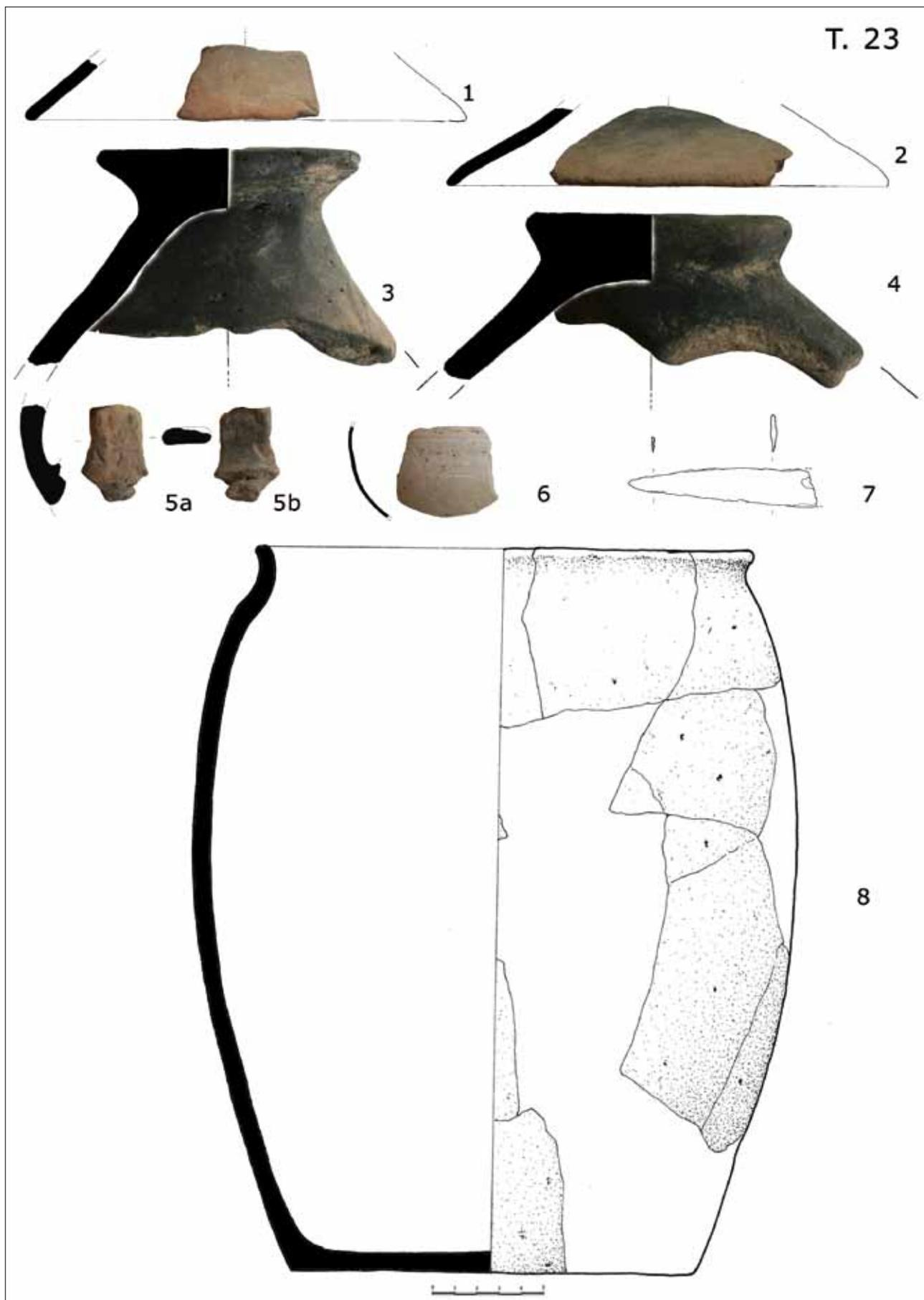

T. 24

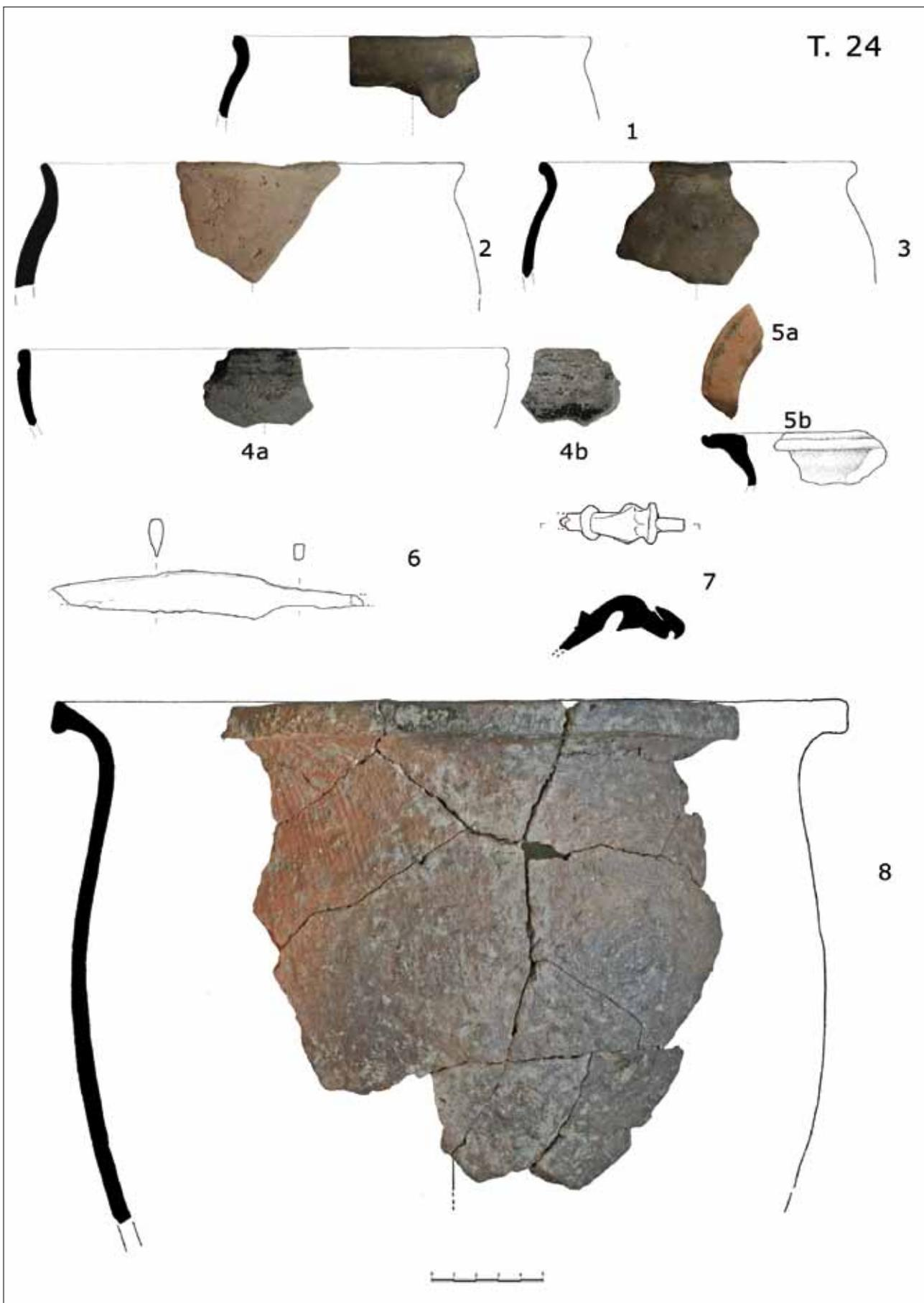

T. 25

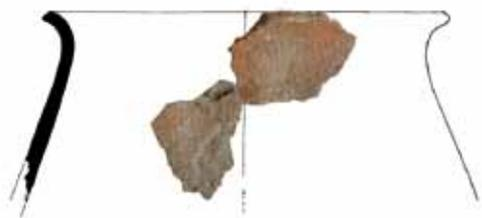

1

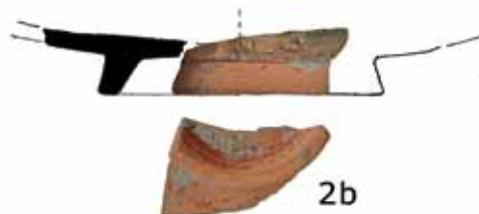

2a

2b



3



4



5

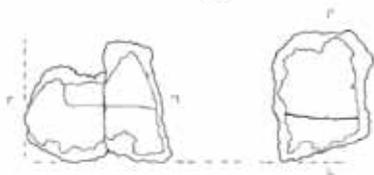

6a



6b

T. 26

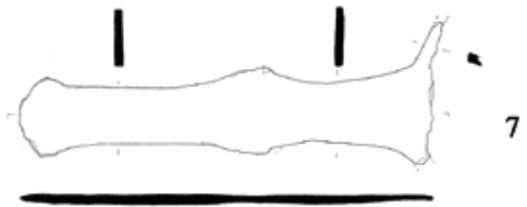
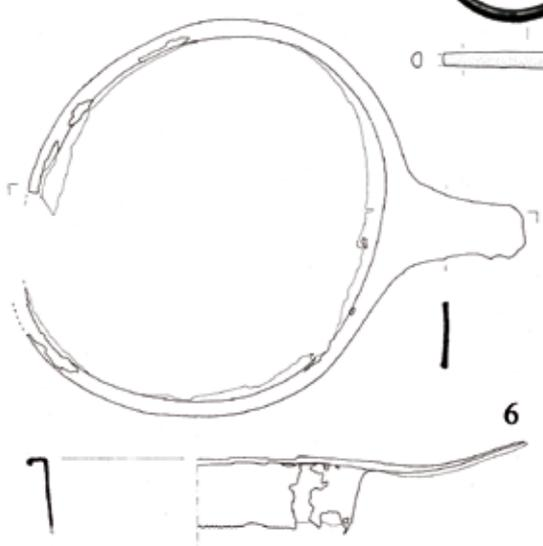

8

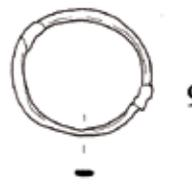

9



10



11a

11b



SJ 001



12

SJ 002



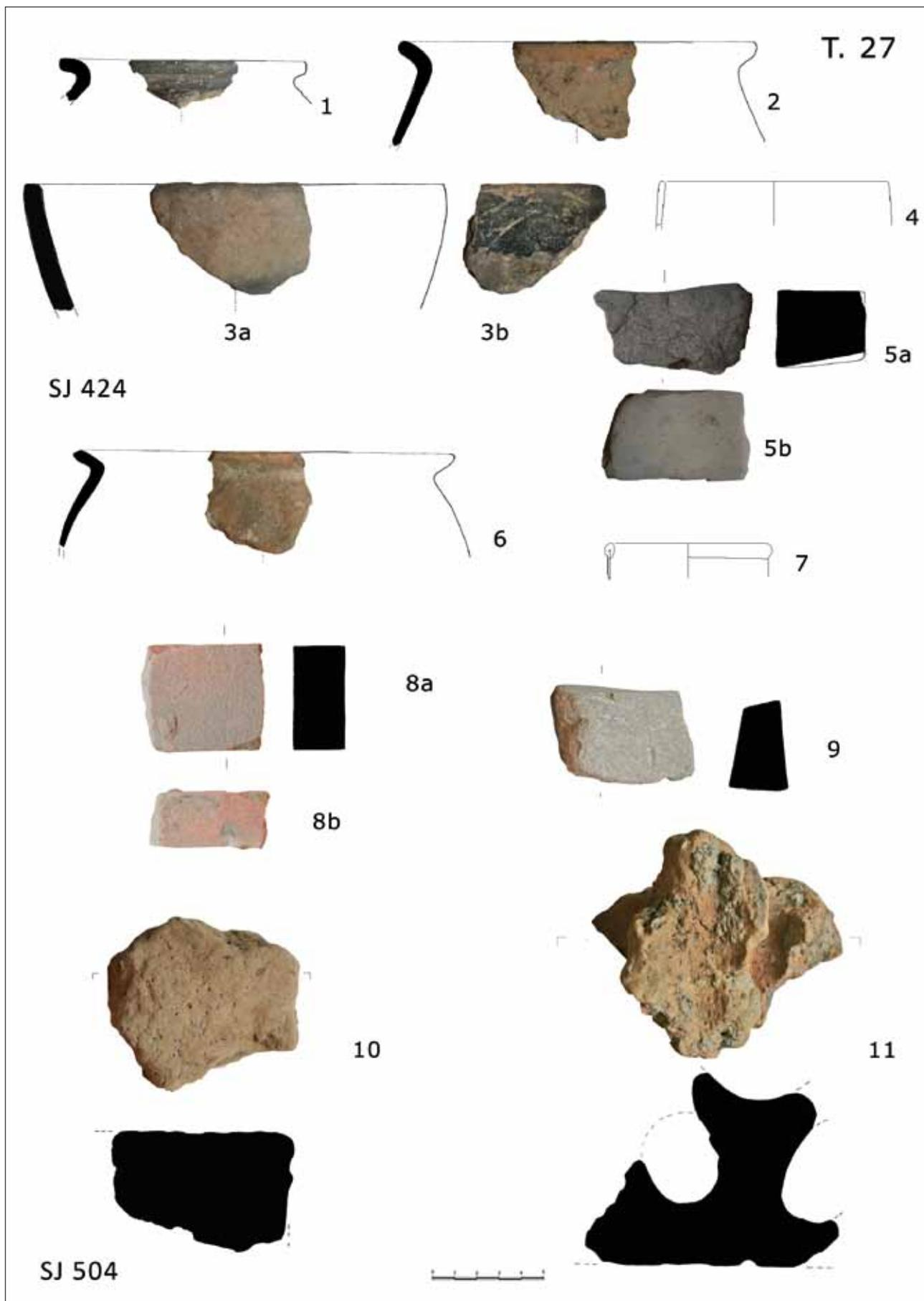



T. 28

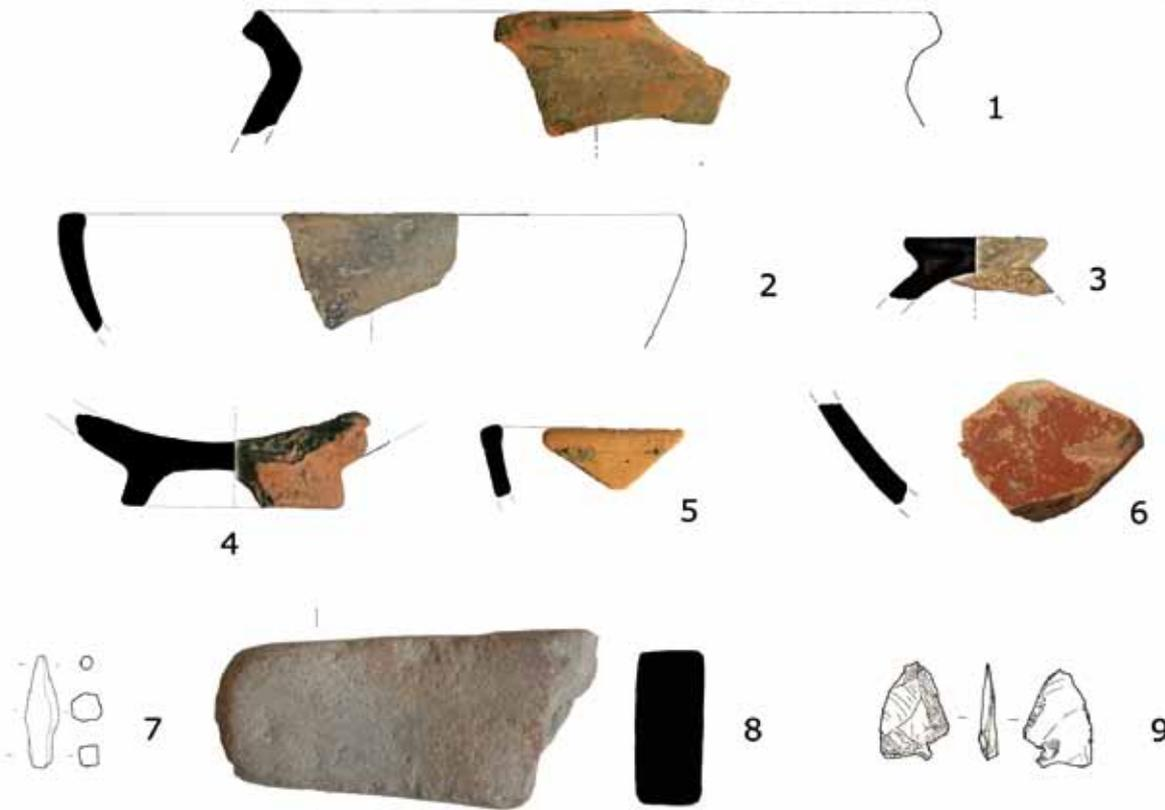

SJ 1018

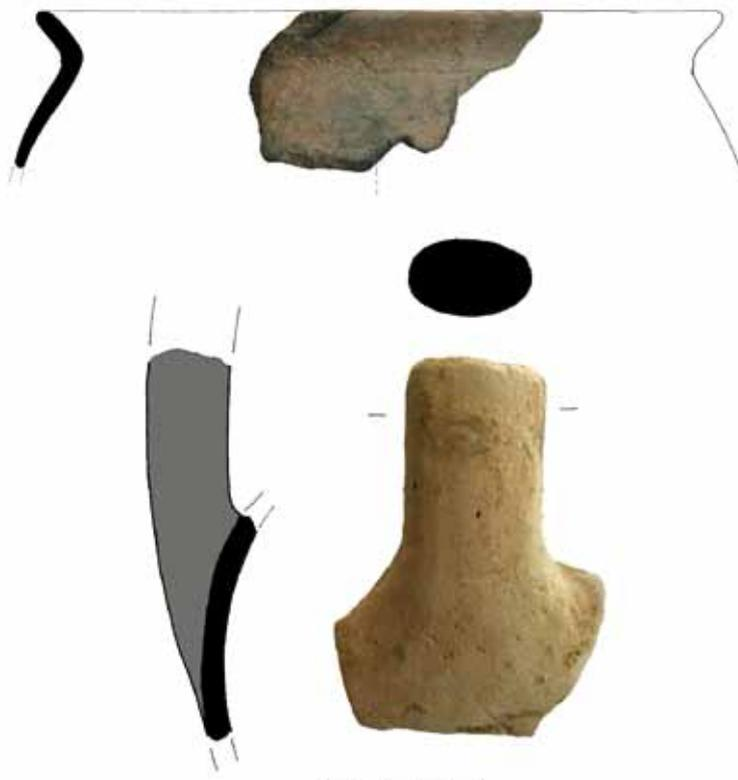

10

11

SJ 1950

III DIO



PART III



## 5.

Arheobotanički i arheozoološki nalazi: prehrambene navike, uzgoj biljaka i životinja na lokalitetu *Virovitica Kiškorija Jug*

*Archaeobotanical and archaeozoological finds: dietary habits, cultivation of plants and animal husbandry at the site of Virovitica Kiškorija South*





## Životinjski ostaci iz rimskog i ranosrednjovjekovnog naselja na nalazištu Virovitica Kiškorija Jug Animal remains from the Roman and early medieval settlements at the Virovitica Kiškorija South

Siniša Radović

### Uvod

Institut za arheologiju je 2005. godine proveo zaštitna arheološka istraživanja na trasi ceste zapadne obilaznice grada Virovitice. Na položaju Kiškorija jug otkriveno je i istraženo antičko naselje. Radi se o ruralnom naselju koje se datira od 2. do sredine 5. st. Istraženi su brojni ostaci stambenih i radnih prostora antičke zajednice dok su istovremeno evidentirani i malobrojni srednjovjekovni stambeni objekti i jame (Jelinčić 2006b). Otkriveno ranosrednjovjekovno naselje razvilo se krajem 8. st. na temeljima antičkog, a koristilo se do kraja 10. st. (Sekelj Ivančan, Tkalčec 2008).

Tijekom istraživanja su uz brojnu pokretnu arheološku građu otkriveni i sakupljeni bioarheološki nalazi, među kojima i malobrojni životinjski ostaci. Kako arheozoološka istraživanja na prostoru kontinentalne Hrvatske još uvijek nisu uobičajena, detaljnom analizom ovih oskudnih ostataka moguće je proširiti naše spoznaje o ekonomiji i prehranbenim navikama ruralnih zajednica na prostoru današnje Podravine u antici i ranom srednjem vijeku.

### Materijal i metode

Životinjski ostaci su sustavno sakupljeni tijekom iskapanja, a samo istraživanje lokaliteta opisano je ranije, u 2. poglavlju. Manji broj sitnijih fragmenata naknadno je otkriven u flotacijskim uzorcima uzetim za arheobotaničke analize, izdvojen i pridodan ukupnom skupu nalaza životinjskih ostataka. Materijal je u cijelosti opran te predan na arheozoološku analizu.

Za anatomsku i taksonomsku determinaciju korišten je recentni i fosilni osteološki materijal iz Komparativne zbirke Zavoda za paleontologiju i geologiju kvartara HAZU, te anatomski priručnici (Hillson 1986; 1992; Schmid 1972; Simić et al. 1988). Taksonomski neodredivi ostaci razvrstani su u dvije opće skupine prema veličini tijela životinja: (1) male (odgovara veličini ovce i koze) i (2) srednje do velike životinje (odgovara veličini svinje, goveda i konja).

Relativna životna dob životinja u trenutku smrti određivana je prema veličini i teksturi kostiju kao i prema sraštavanju epifiza (Reitz, Wing 1999: 76, Tab. 3.5; Silver 1969). Kada je bilo moguće određivana je preciznija dob temeljem faza nicanja zuba i stupnja potrošenosti žvačnih ploha, prema uobičajenim kriterijima za ovce i/ili koze

### Introduction

In 2005, during the rescue archaeological excavations on the road route of the west beltway of Virovitica conducted by the Institute of Archaeology, a Roman period settlement was discovered at the Virovitica Kiškorija south site. It was a village dated to the period between the 2<sup>nd</sup> and the 5<sup>th</sup> century. Numerous residential and working structures from Roman period were studied, simultaneously revealing a small number of medieval features (Jelinčić 2006b). Discovered early medieval settlement has developed in the late 8<sup>th</sup> century on the grounds of former Roman village, and was in use until the end of the 10<sup>th</sup> century (Sekelj Ivančan, Tkalčec 2008).

Along with numerous archaeological finds the excavations also revealed bioarchaeological remains, including a small number of animal bones and teeth. Nevertheless, due to paucity of archaeozoological research in the continental Croatia, it is possible to extend our understanding of Roman period and early Middle Ages economy and dietary habits of rural communities in the area of today Podravina through analysis of these remains.

### Material and Methods

Animal remains were systematically collected during the excavations, with the recovery methods already described earlier, in the 2<sup>nd</sup> chapter. A few smaller fragments were subsequently recovered in the flotation samples taken for archaeobotanical analysis, separated and added to the total faunal assemblage. The material is washed and then submitted for archaeozoological analysis.

For the anatomical and taxonomical identification of animal remains, a modern and fossil osteologic comparative material was used from the collection of the Institute for Quaternary Palaeontology and Geology, Croatian Academy of Sciences and Arts, as well as standard anatomical manuals (Hillson 1986; 1992; Schmid 1972; Simić et al. 1988). Taxonomically indeterminate remains were sorted into two general categories based on the size of the animals: (1) small (the size of sheep, goat) and (2) medium to large animals (pig, cattle, horse).

Relative age at death was determined according to bone size and surface texture, as well as by epiphyseal fusion (Reitz, Wing 1999: 76, Tab. 3.5; Silver 1969). Where possible, tooth eruption and occlusal wear data were used for precise ageing following criteria set for sheep/goat (Payne



(Payne 1973) i za svinje i goveda (Grant 1982).

Zastupljenost taksona kao i taksonomski neodredivih skupina iskazana je sljedećim kvantitativnim metodama: broj odredivih uzoraka (NISP = *Number of Identified Specimens*) i najmanji broj anatomskih elemenata (MNE = *Minimum Number of Elements*). Prilikom određivanja NISP i MNE, kao osnovni kriterij preuzeta je definicija prema kojoj je *uzorak* svaka pojedinačna kost ili zub, ili njihov fragment, dok je *element* cijela kost ili zub (Lyman 1994: 100; Reitz, Wing 1999: 10). Kao osnovna kvantitativna metoda korišten je NISP, koji je malo modificiran i prilagođen osobitostima samog arheozoološkog materijala. S obzirom na to da su životinjski ostaci izrazito loše očuvani i podložni daljnjem uništavanju, u pojedinim slučajevima kada se moglo utvrditi da su dva ili više fragmenta vjerojatno dijelovi iste kosti, tretirani su kao jedan uzorak. Iako se ovako smanjio broj odredivih uzoraka (NISP), on realnije odražava stvarnu veličinu skupa nalaza životinjskih ostataka na ovom nalazištu.

MNE je određivan isključivo za taksonomski odredive ostatke unutar pojedinih stratigrafskih kompleksa i jedinica, pri čemu se pazilo na orijentaciju samih elementa i životnu dob životinja. Rog (*cornu*) i kosti glave (*cranium*) tretirani su kao različiti elementi dok je zubima određivan skupni MNE posebno za gornje (*dentes sup.*), donje (*dentes inf.*) i neodredive zube (*dentes indet.*). MNE nije određivan za stratigrafski nesigurne nalaze.

## Rezultati

### Skup nalaza faune

Sakupljeno je 548 fragmenata životinjskih kostiju i zuba ukupne težine 1,1 kg (Tab. 4). Od toga, 212 fragmenata je samo prebrojano i izvagano (anatomski i taksonomski neodredivo iz stratigrafski nesigurnog konteksta SJ 504) dok je preostalih 336 detaljno analizirano. Time je u cijelosti obuhvaćen faunski materijal iz rimskog i srednjovjekovnog konteksta dok su djelomično analizirani životinjski ostaci iz nesigurnih stratigrafskih jedinica.

Spaljeno je 65 fragmenata (11,9 %; Tab. 4). Svi fragmenti potpuno su bijele boje i teksture slične kredi, što indicira da su bili izloženi vrlo intenzivnom gorenju pri visokim

1973) and for pig and cattle (Grant 1982).

The following quantitative units were used to show the representation of taxa as well as of taxonomically indeterminate size categories: Number of Identified Specimens (NISP), and Minimum Number of Elements (MNE). For the purposes of determining the NISP and MNE, as a basic criterion *specimen* is defined as a bone or tooth, or fragment thereof, while an *element* is a single complete bone or tooth (Lyman 1994: 100; Reitz, Wing 1999: 10). The NISP is, as a basic quantitative unit, slightly modified and adjusted according to specifics of faunal material. Given the very poor preservation state of the animal remains and their continuous destruction, in cases where two or more fragments came from the same bone or tooth even if they could not be conjoined, all were treated as a single specimen. Although this reduced the total NISP, it reflects more accurately the actual size of the faunal assemblage at this site.

The MNE has been calculated exclusively for the remains identified to taxa within the stratigraphic complexes and units, taking into consideration side of the element in a skeleton and age at death. Horn core (*cornu*) and cranial bones (*cranium*) were treated as separate elements, while teeth were grouped into upper (*dentes sup.*), lower (*dentes inf.*) and indeterminate (*dentes indet.*) for the purpose of calculating MNE. Finds found out of context were not included.

## Results

### Overall faunal assemblage

A total of 548 animal bone and teeth fragments were recovered weighing 1.1 kg (Tab. 4). Of these remains, 212 fragments were only counted and weighed (unidentifiable remains from the mixed context SU 504) while the remaining 336 fragments were analysed in detail. Overall, the complete Roman and medieval faunal assemblages are included, with the stratigraphically unreliable material only being partially analysed.

65 fragments were burnt (11.9 %; Tab. 4). All are completely white in colour and chalky in texture, suggesting that they had been exposed to very intensive burning under high temperatures (Lyman 1994: 385). Majority of these

	frag. (n)	tež. / wt (g)	spaljeno / burnt (n)	spaljeno / burnt (%)	NISP
RIM	216	246,3	21	9,7	47
SV	86	28,5	43	50,0	17
X	246	795,5	1	0,4	22
Σ	548	1070,3	65	11,9	86

\* RIM = rimsko razdoblje / Roman period; SV = srednji vijek / Middle Ages.; X = izvan konteksta / Out of context.

Tablica 4 Virovitica Kiškoriya jug. Opći sastav skupa nalaza životinjskih ostataka

Table 4 Virovitica Kiškoriya South. Overall faunal assemblage



temperaturama (Lyman 1994: 385). Najveći dio ovih spaljenih kostiju dolazi iz flotacijskih uzoraka. Kako niti na jednom taksonomski određenom ili na bilo koji način anatomski značajnom fragmentu nisu ustanovljeni tragovi gorenja nije moguće raspravljati o procesima koji su utjecali na takvo stanje odnosno tragovima eventualne pripreme hrane.

Bitan tafonomski čimbenik koji je utjecao na očuvanost životinjskih ostataka i njihovu zastupljenost na ovom nalazištu je kiselost tla. Već je prilikom iskopavanja ustanovljeno da su bioarheološki ostaci izrazito loše očuvani te se raspadaju, što je potvrđeno tijekom arheozooloških analiza. Rađene su analize uzoraka sedimenata koje su potvrdile izrazitu kiselost na ovom položaju (Šoštarić et al. predano za tisak). Takvo stanje u tlu može biti katastrofalno za kosti (Nielsen-Marsh et al. 2007) što se potvrdilo u ovom slučaju. Životinjski ostaci su malobrojni, izrazito razlomljeni te uništeni djelovanjem kemijskih procesa. U većini slučajeva preživjeli su samo zubi (Tab. 7) što ne čudi s obzirom na njihov mineralni sastav (Hillson 1986) zbog čega su otporniji na destruktivne dijagenetske procese u tlu. Iz istih razloga svi pretpostavljeni tragovi mesarenja na kostima potpuno su uništeni.

Zbog malobrojnosti materijala, detaljno je analiziran cjelokupni sastav faune iz antičkog i srednjovjekovnog konteksta, dok su nalazi izvan konteksta djelomično obrađeni pri čemu su obuhvaćeni svi anatomski značajni fragmenti.

#### Nalazi iz antičkog konteksta

Sakupljeno je ukupno 47 životinjskih kostiju i zuba (Tab. 5), od čega je 61,7 % bilo taksonomski određivo (NISP=29). Najbrojniji su ostaci goveda (*Bos taurus*; NISP=15) dok je nešto manje ovaca i/ili koza (*Ovis/Capra*; NISP=10). Od ostalih taksona zastupljeni su malobrojni ostaci ekvida (*Equus/Asinus*; NISP=3) i svega jedan fragmentirani zub svinje (*Sus sp.*; NISP=1). Među taksonomski neodredivim ostacima, dio je prema stanovitim morfološkim obilježjima bilo moguće razvrstati u dvije opće skupine prema veličini tijela životinje (NISP=8). Preostali dio materijala sastoji se od jako sitnih i oštećenih fragmenata bez ikakve mogućnosti anatomskog prepoznavanja (NISP=10).

Svi nalazi iz antičkog konteksta analizirani su prema stratigrafskim kompleksima i jedinicama (Tab. 5). Detaljni opis već je ranije prikazan (Šoštarić et al. predano za tisak) pa ovdje slijedi opis materijala po taksonima.

Osim što su najbrojniji, ostaci goveda (*Bos taurus*) najbolje su i očuvani. Skoro sve su zubi ili fragmenti zuba i grupirani su u dva kompleksa (Tab. 5-7). U kompleksu 2<sup>1</sup>

burnt bones comes from the flotation samples. Since not a single taxonomically identified or otherwise anatomically significant specimen revealed traces of burning, one cannot argue about the processes which have caused this or can be related to food preparation.

The important taphonomical factor that influenced the preservation of animal remains and their representation at this site is soil acidity (pH). The excavations revealed extremely bad state of the bioarchaeological finds and their further decomposing, as confirmed during faunal analysis. Soil samples were analysed verifying extreme acidity at this location (Šoštarić et al. in prep.). Such state of the soil can be disastrous for the bones (Nielsen-Marsh et al. 2007) as proved in this case. The animal remains are few in number, highly fragmented and destroyed by chemical processes. In most cases only teeth have survived (Tab. 7), which is not surprising considering their mineral composition (Hillson 1986) which makes them more resistant to destructive diagenetic processes in the soil. For the same reason all of the potential butchery marks are completely lost.

Due to a small size of the overall faunal assemblage, the complete assemblages from the Roman period and the Middle Ages were analysed in detail, while the faunal material found out of context has been only partially analysed, still including all anatomically relevant fragments.

#### Roman period assemblage

A total of 47 animal bones and teeth was collected (Tab. 5), of which 61.7 % are identified to taxa (NISP=29). The most numerous are the remains of cattle (*Bos taurus*; NISP=15) while there is somewhat less of sheep and/or goat (*Ovis/Capra*; NISP=10). Other taxa are represented by a few equid remains (*Equus/Asinus*; NISP=3) and a single fragmented pig's tooth (*Sus sp.*; NISP=1). Among taxonomically indeterminate remains, a part was possible to sort into two general categories based on the size of the animals (NISP=8). The remaining material consists of very small and damaged fragments beyond any anatomical recognition (NISP=10).

All faunal finds from the Roman period were analysed according to stratigraphic complexes and units (Tab. 5). Detailed description has been presented elsewhere (Šoštarić et al. in prep.) so here follows a description of the material by taxa.

Besides being the most numerous, the remains of cattle (*Bos taurus*) are also the best preserved. They consists of almost exclusively teeth or their fragments which are grouped into two complexes (Tab. 5-7). In the complex 2<sup>1</sup> a total of seven fragmented isolated cattle teeth were found: right

1 Rezultati analize životinjskih ostataka iz antičkog kompleksa prikazani su već ranije (Šoštarić et al. predano za tisak). U tom su radu stratigrafski kompleksi označeni slovima radi uredničkih normi i uključuju samo komplekse u kojima su pronađeni bioarheološki ostaci. Ovdje su stratigrafski kompleksi označeni brojevima u skladu s izvornom dokumentacijom (poglavlje 2.3 u ovoj knjizi). Korelacija novih (brojevi) i starih (slova) oznaka stratigrafskih kompleksa: 1.=A, 2.=B, 3.=C, 4.=D, 5.=E, 9.=G.

1 The results of faunal analysis of Roman period assemblage has been shown earlier (Šoštarić et al. in prep.). In that paper stratigraphic complexes are labeled with letters following editorial standards, and only complexes where bioarchaeological remains have been found are included. Here, stratigraphic complexes are labeled with number in accordance with the original documentation (chapter 2.3 in this book). Correlation of new (numbers) and old (letters) labels of stratigraphic complexes: 1.=A, 2.=B, 3.=C, 4.=D, 5.=E, 9.=G.





	RIM															Σ
	1. kompleks	2. kompleks	3. kompleks	4. kompleks	5. kompleks	9. kompleks	SJ 732 / 733	SJ 802 / 803	SJ 1037 / 1038	SJ 1221 / 1222	SJ 1233 / 1234	SJ 1309 / 1310	SJ 1333 / 1334	SJ 1363 / 1364	SJ 1453 / 1454	
<i>Ovis / Capra</i>		1		1			1		1		1	1			4	10
<i>Sus sp.</i>				1												1
<i>Bos taurus</i>		7	1	6				1								15
<i>Equus / Asinus</i>				3												3
Σ (takson. odred. / ID to taxa)		8	1	11			1	1	1		1	1			4	29
mala živ. / small sized				1									1	3		5
sred.-vel. živ. / med.-large sized					1	1									1	3
Σ (veličina tijela / body size)				1	1	1							1	3	1	8
neodredivo / indeterminate	1	1	1	2	2	1		1		1						10
Σ (total)	1	9	2	14	3	2	1	2	1	1	1	1	1	3	5	47

\* RIM: rimsko razdoblje / Roman period.

304

	SV								X						Σ (total)	
	SJ 019 / 020	SJ 029 / 030	SJ 118 / 119	SJ 368 / 369	SJ 1211 / 1212	SJ 1357 / 1358	SJ 2028 / 2029	SJ 2151 / 2152	Σ	SJ 001	SJ 002	SJ 001, 002, 003	SJ 504	SJ 1018		Σ
<i>Ovis / Capra</i>			2					1	3				1		1	14
<i>Sus sp.</i>													3		3	4
<i>Bos taurus</i>		1		1						1			8	1	10	27
<i>Equus / Asinus</i>													3		3	6
Σ (takson. odred. / ID to taxa)		1	2	1				1	5		1		15	1	17	51
mala živ. / small sized			1						1				1		2	8
sred.-vel. živ. / med.-large sized			3								1	2			3	9
Σ (veličina tijela / body size)			4						4	1	1	3			5	17
neodredivo / indeterminate	1		3	1	1	1	1		8				-		-	18
Σ (total)	1	1	9	2	1	1	1	1	17	1	1	1	18	1	22	86

\* SV: srednji vijek / Middle Ages; X: izvan konteksta / Out of context.

Tablica 5 Virovitica Kiškoriya jug. Životinjski ostaci (NISP) po kompleksima i stratigrafskim jedinicama  
Table 5 Virovitica Kiškoriya South. Animal remains (NISP) by stratigraphic complexes (kompleks) and units (SJ)



	RIM										SV					Σ (total)
	2. kompleks	3. kompleks	4. kompleks	SJ 732 / 733	SJ 802 / 803	SJ 1037 / 1038	SJ 1233 / 1234	SJ 1309 / 1310	SJ 1453 / 1454	Σ	SJ 029 / 030	SJ 118 / 119	SJ 368 / 369	SJ 2151 / 2152	Σ	
<i>Ovis / Capra</i>	1		1	1		1	1	1	2			1		1	2	10
<i>Sus sp.</i>			1													1
<i>Bos taurus</i>	3	1	2		1						1		1		2	9
<i>Equus / Asinus</i>			1													1
Σ (total)	4	1	5	1	1	1	1	1	2		1	1	1	1	4	21

\* RIM: rimsko razdoblje / Roman period; SV: srednji vijek / Middle Ages.

Tablica 6 Virovitica Kiškoriya jug. Najmanji broj elemenata (MNE) po kompleksima i stratigrafskim jedinicama (SJ)

Table 6 Virovitica Kiškoriya South. The Minimum Number of Elements (MNE) by stratigraphic complexes (kompleks) and units (SJ)

ukupno je određeno sedam fragmentiranih izoliranih zuba goveda: desni gornji treći molar ( $M^3$ ), desni donji treći molar ( $M_3$ ) i neodređivi donji molar ( $M_{1/2}$ ) iz SJ 114/115; dva jako oštećena ulomka možda istog neodredivog molara iz SJ 425/426; i lijevi donji drugi ( $M_2$ ) i treći molar ( $M_3$ ) koji vjerojatno potječu iz iste čeljusti. U 4. kompleksu pronađeno je šest izoliranih zuba. Pet gornjih zuba (SJ 499/500) sastoje se od dva artikulirajuća djelomična zubna niza (lijevi  $M^2-M^3$  i desni  $M^1-M^3$ ) iz iste gornje čeljusti adultne jedinke. Istoj životinji možda je pripadao i fragment izoliranog donjeg molara ( $M_{1/2}$ ) iz SJ 404/405. Jedini koštani ostatak goveda izrazito je oštećeni i razlomljeni proksimalni kraj desne metakarpalne kosti iz kompleksa 3 (SJ 104/105).

Malobrojni ostaci ovce i/ili koze (*Ovis/Capra*; Tab. 5–6) iz antičkih slojeva također se sastoje gotovo isključivo od izoliranih fragmenata zuba (Tab. 7). Iznimka su jedan jako mali ulomak roga iz kompleksa 4 (SJ 497/498) i djelomično sačuvana desna mandibula sa zubima ( $dP_4$ ,  $M_1$ ,  $M_2$ ) iz SJ 1453/1454 (N-672, inv. 1). Prema morfološkim obilježjima donjeg mliječnog premolara ( $dP_4$ ; Payne 1985) ova je mandibula specifički određena kao koza (*Capra hircus*). Prema stupnju dentalnog razvoja i trošenja žvačnih površina može se pretpostaviti kako je životinja imala između jedne i dvije godine u trenutku smrti (Payne 1973). Preostali nalazi ovce i/ili koze sastoje se od fragmentiranih izoliranih zuba od kojih je bilo moguće prepoznati jedan gornji neodređivi molar s jako malim koštanim fragmentom gornje čeljusti (SJ 1037/1038) i jedan razlomljeni izolirani lijevi donji treći molar ( $M_3$ ) odrasle jedinke (SJ 1309/1310). Osim gore opisane mandibule sa zubima koze ostali nalazi nisu dovoljno sačuvani za specifičku odredbu. Međutim, prema nalazu željezne češagije za vunu iz kompleksa 2 (Šoštarić et al. predano za tisak) može se posredno pretpostaviti i prisustvo ovce (*Ovis aries*) u ovom rimskom selu.

Ostaci neodređenog ekvida (konj/magarac/mula; *Equus/Asinus*) otkriveni su isključivo u kompleksu 4 (SJ

upper third molar ( $M^3$ ), right lower third molar ( $M_3$ ) and indeterminate lower molar ( $M_{1/2}$ ) from SU 114/115; two severely damaged fragments of what could be the same indeterminate molar from SU 425/426; and left lower second ( $M_2$ ) and third molars ( $M_3$ ) which probably came from the same jaw. The complex 4 revealed six isolated teeth. Five upper teeth (SU 499/500) articulate with each other and form two partial dentitions (left  $M^2-M^3$  and right  $M^1-M^3$ ) from the same adult animal. A fragment of the isolated lower molar ( $M_{1/2}$ ) from SU 404/405 may also have belonged to this individual. Extremely damaged and fractured proximal end of the right metacarpal from the complex 3 (SU 104/105) is the only bone remain of the cattle.

Small number of the sheep and/or goat remains (*Ovis/ Capra*; Tab. 5–6) from the Roman period, are also almost exclusively represented by isolated teeth fragments (Tab. 7). The exceptions are a very small horn core fragment from the complex 4 (SU 497/498) and partially preserved right mandible with teeth ( $dP_4$ ,  $M_1$ ,  $M_2$ ) from the SU 1453/1454 (N-672, inv. 1). On the basis of morphological criteria for the lower milk premolar ( $dP_4$ ; Payne 1985) this mandible is identified as goat (*Capra hircus*). Based on dental development and occlusal wear it can be assumed that animal was between one and two years old when culled (Payne 1973). Other sheep and/or goat remains consist of fragmented isolated teeth, of which an upper indeterminate molar with very small fragment of maxillary bone still attached (SU 1037/1038), and one fragmented isolated left lower third molar ( $M_3$ ) of the adult animal (SU 1309/1310), were only anatomically identifiable. In addition to the above described goat mandible with teeth, other remains were not sufficiently preserved to be identified to species. However, based on the iron curry comb for wool found in the complex 4 (Šoštarić et al. in press.) one can indirectly assume the presence of sheep (*Ovis aries*) in this Roman village.

The remains of indeterminate equid (horse/ass/mule;



	Ovis / Capra			Sus sp.			Bos taurus			Equus / Asinus		
	RIM	SV	X	RIM	SV	X	RIM	SV	X	RIM	SV	X
cranium	-	-	-	-	-	-	-	-	1 (-)	-	-	-
cornu	1 (1)	-	-	-	-	-	-	-	1 (-)	-	-	-
dentes sup.	1 (1)	-	-	-	-	-	6 (3)	-	-	-	-	1 (-)
mandibula	1 (1)	-	-	-	-	1 (-)	-	-	1 (-)	-	-	-
dentes inf.	4 (2)	1 (1)	1 (-)	-	-	2 (-)	5 (2)	1 (1)	-	3 (1)	-	-
dentes indet.	3 (3)	2 (1)	-	1 (1)	-	-	3 (1)	1 (1)	2 (-)	-	-	-
scapula	-	-	-	-	-	-	-	-	1 (-)	-	-	-
radius	-	-	-	-	-	-	-	-	2 (-)	-	-	-
metacarpus	-	-	-	-	-	-	1 (1)	-	-	-	-	-
pelvis	-	-	-	-	-	-	-	-	-	-	-	1 (-)
tibia	-	-	-	-	-	-	-	-	2 (-)	-	-	-
phalanx I	-	-	-	-	-	-	-	-	-	-	-	1 (-)
Σ (total)	10 (8)	3 (2)	1 (-)	1 (1)	-	3 (-)	15 (7)	2 (2)	10 (-)	3 (1)	-	3 (-)

\* RIM: rimsko razdoblje / Roman period; SV: srednji vijek / Middle Ages; X: izvan konteksta / Out of context.

Tablica 7 Virovitica Kiškoriya jug. Zastupljenost anatomskih elemenata po taksonima (NISP – izvan zagrade, MNE – u zagradi)  
 Table 7 Virovitica Kiškoriya South. Frequency of anatomical elements by taxa (NISP – outside the brackets, MNE – inside the brackets)

509/510). Veći broj jako razlomljenih ulomaka cakline i dentina ostatak su od najmanje tri različita izolirana donja molara vjerojatno iz iste čeljusti (Tab. 5–7). Nažalost, uslijed ekstremne razlomljenosti ovih ostataka nije moguće reći ništa više o samoj životinji.

Jedini nalaz svinje (*Sus sp.*) u antičkom kontekstu je ulomak zametka neodredivog molara iz kompleksa 4 (SJ 404/405; Tab. 5–7). Temeljem stupnja razvoja zuba može se pretpostaviti da je pripadao jako mladoj svinji (odojak).

Među taksonomski neodredivim ostacima (Tab. 5) nalaze se jako fragmentirani ostaci zuba preživača i neodredivi ulomci kostiju (dijafize, spongioze). Jedini anatomske odredivi komad je posteriorni fragment baze mandibule (*angulus mandibulae*) srednje do velike životinje (SJ 642/643). Većina ovih ostataka izrazito je oštećena i potpuno spaljena (Tab. 4)

*Nalazi iz srednjovjekovnog konteksta*

Sakupljeno je svega 17 životinjskih kostiju i zuba (Tab. 5) što je manje nego u antičkom kontekstu, ali je u skladu s općenito znatno manjom zastupljenošću srednjovjekovnih nalaza i objekata na samom nalazištu (Jelinčić 2006b). Od toga, 29,4 % je taksonomski određeno (NISP=5). Ostatak, koji je bio taksonomski neodrediv, razvrstan je u jednu od dvije opće skupine prema veličini tijela životinje (NISP=4) ili ostavljen kao potpuno neodrediv (NISP=8).

Sa svega tri fragmenata, ovca i/ili koza (*Ovis/Capra*) najbrojnija je taksonomska skupina unutar srednjovjekovnog konteksta (Tab. 5–7). Među izrazito razlomlje-

*Equus/Asinus*) were discovered only in the complex 4 (SU 509/510). A large number of highly fractured enamel and dentin fragments belonged to at least three different lower molars, probably coming from the same mandible (Tab. 5–7). Unfortunately, due to extreme fragmentation of these remains it is not possible to say anything more about the animal.

A single pig remain (*Sus sp.*) from the Roman period is a fragmented tooth bud of the indeterminate molar from the complex 4 (SU 404/405; Tab. 5–7). On the basis of tooth development it can be assumed that it belonged to a very young pig (suckling pig).

Taxonomically indeterminate remains (Tab. 5) consist of very fragmented remains of the ruminant teeth and unidentifiable bone fragments (e.g. shafts, cancellous bone). A fragment of mandible heel (*angulus mandibulae*) of a middle to large sized animal (SU 642/643) is the only one identified to element. Majority of these remains are highly fragmented and completely burnt-calcined (Tab. 4).

*Medieval assemblage*

Only 17 animal bones and teeth were collected (Tab. 5), which is less than in the Roman period assemblage but in accordance with generally much lower frequency of medieval finds and structures at the site (Jelinčić 2006b). Of that, 29.4 % are identified to taxa (NISP=5). The remaining taxonomically indeterminate material was sorted into one of the two general size-based categories (NISP=4) or left as absolutely indeterminate (NISP=8).

The most common taxonomic category within medie-



nim ulomcima zuba određen je samo jedan potpuno spaljen izolirani lijevi donji molar ( $M_{1/2}$ ; SJ 118/119). Na žvačnoj površini nema vidljivog trošenja što ukazuje da je pripadao mladoj životinji.

Govedo je zastupljeno sa samo dva fragmentirana zuba (Tab. 5–7): izrazito razlomljeni neodređivi molar (SJ 029/030) i ulomak izoliranog donjeg trećeg molara ( $M_3$ ; SJ 368/369). Iako je oštećena žvačna površina donjeg trećeg molara, čini se da nema trošenja, a sama kruna još nije formirana, stoga se može pretpostaviti da je zub nedavno izbio što ukazuje na subadultnu životinju.

Među taksonomski neodredivim ostacima (Tab. 5) prepoznati su potpuno spaljen mali ulomak tijela petne kosti (*calcaneus*) i fragmentirana baza mandibule srednje velike životinje iz SJ 118/119. Svi neodređivi fragmenti su potpuno spaljeni (Tab. 4).

#### Nalazi izvan konteksta

Životinjski ostaci skupljeni u nesigurnim stratigrafskim kontekstima nisu u cijelosti analizirani, što je već ranije rečeno u tekstu. Obuhvaćeni su samo anatomske značajni fragmenti što je ograničilo analizirani uzorak na 22 komada (NISP) od kojih najveći dio potječe iz iste SJ 504 (Tab. 5). Veći dio bio je taksonomski odrediv (77,3 %) dok je ostatak samo razvrstan u dvije skupine prema veličini.

U skladu s materijalom iz stratigrafski sigurnih kompleksa i jedinica, i ovdje su najbrojniji ostaci domaćeg goveda (*Bos taurus*; 58,8 %). Ističe se veći broj skeletnih u odnosu na dentalne elemente što je bitna razlika naspram anatomske zastupljenosti životinjskih ostataka iz rimskodobnih i srednjovjekovnih slojeva (Tab. 7). Većina nalaza goveda pronađena je u naplavnom sloju SJ 504. Elementi glave su zastupljeni ulomkom desne temporalne kosti s artikulacijskom facetom za uzglobljivanje s mandibulom, fragmentom roga i jako malim ulomkom lijeve mandibule s djelomično sačuvanom praznom alveolom za treći molar. Od elemenata prednje noge evidentirani su fragment distalnog kraja desne lopatice (*scapula*) i nesrasla distalna epifiza desne palčane kosti (*radius*), kao i ulomak proksimalnog dijela dijafize palčane kosti. Stražnja je noga zastupljena s dva ulomka goljenične kosti (*tibia*): fragment proksimalnog kraja i razlomljeni distalni kraj. Oba ulomka goljenične kosti imaju srasle epifize te su mogli pripadati istom odraslom govedu. Općenito, sakupljeni ostaci goveda su pripadali najmanje dvjema jedinkama (juvenilna i adultna).

Malobrojni ostaci su pripadali neodređenom ekvidu (*Equus/Asinus*; Tab. 5, 7): fragmentirani gornji lijevi zub (pre-molar ili molar) odrasle životinje, veći dio desne zdjelice kosti (*pelvis*) sa razlomljenim acetabulumom i dijelom crijevnice kosti, i mali ulomak distalnog dijela prve falange. Nažalost, iako reprezentativni u odnosu na nalaze iz stratigrafski jasnih cjelina, ovi ostaci su u lošem stanju pa nije bilo moguće napraviti metrijsku analizu s ciljem eventualne generičko/specifičke odredbe.

val assemblage is sheep and/or goat (*Ovis/Capra*), represented by only three fragments (Tab. 5–7). Among extremely broken teeth fragments a single completely burnt isolated left lower molar ( $M_{1/2}$ ; SU 118/119) is identified. Unworn occlusal surface suggests that this tooth belonged to a juvenile animal.

Cattle is represented by only two fragmented teeth (Tab. 5–7): extremely fragmented indeterminate molar (SU 029/030) and a fragment of isolated lower third molar ( $M_3$ ; SU 368/369). Although the occlusal surface of the lower third molar is damaged, it seems that there is no wear, and the crown itself has not yet formed, so it can be assumed that the tooth erupted recently indicating a subadult animal.

Among taxonomically indeterminate remains (Tab. 5) a completely burnt small fragment of the heel bone (*calcaneus*) and fragmented mandible base of the medium sized animal from the SU 118/119 are the only identified to element. All unidentifiable fragments are completely burnt (Tab. 4).

#### Out of context assemblage

Animal remains from the stratigraphically unreliable contexts have only been partially analysed, as mentioned earlier in the text. It includes only anatomically significant specimens limiting the analysed sample to 22 fragments (NISP) of which the majority came from the same SU 504 (Tab. 5). Most of it was identified to taxa (77.3 %) with the rest only sorted into two size-based categories.

In accordance with the material from the stratigraphically secured complexes and units, the most numerous are the remains of cattle (*Bos taurus*; 58.8 %). The higher frequency of skeletal elements stands out as an important difference between the Roman period and the medieval assemblages, where teeth are dominant (Tab. 7). Most of the cattle remains were found in the alluvial layer SU 504. The head is represented by a fragment of the right temporal bone with articular facet for the mandible articulation, horn core fragment, and a very small fragment of the left mandible with partially preserved empty alveolus for the third molar. Elements of the front legs include a fragment of the distal end of the right shoulder blade (*scapula*) and an unfused distal epiphysis of the right radius, as well as a fragment of proximal radial shaft. The hind legs are represented by two fragments of tibia: a fragment of the proximal end and a broken distal end. Both fragments have fused epiphyses and could belong to the same animal. Overall, collected cattle remains came from at least two individuals (juvenile and adult).

Only a few remains were identified to indeterminate equid (*Equus/Asinus*; Tab. 5, 7): fragmented upper left tooth (pre-molar or molar) of an adult animal, most of the right innominate (*pelvis*) with fractured acetabulum and portion of ilium, and a small fragment of a distal portion of the first phalanx. Although representative in comparison with finds from stratigraphically secured contexts, these remains are unfortunately in a poor condition and therefore insuf-



Svinja (*Sus* sp.; Tab. 5, 7) je zastupljena s fragmentom mandibule sa zubima ( $M_1$ ,  $M_2$ ). Prema stupnju potrošenosti žvačnih površina može se pretpostaviti da je životinja bila stara između 1 i 2 godine, a male dimenzije sugeriraju da se vjerojatno radi o domaćoj formi (*Sus domesticus*).

Fragment neodredivog donjeg molara jedini je nalaz ovce ili koze (*Ovis/Capra*; Tab. 5, 7) među životinjskim ostacima pronađenim izvan sigurnog konteksta.

Od svih stratigrafski upitnih cjelina, u SJ 504 pronađeno je najviše životinjskih ostataka. Općenito, ti su nalazi bolje očuvani u odnosu na one iz rimskih i srednjovjekovnih cjelina te se ističu znatno boljom zastupljenošću skeletnih elemenata. Također vrijedi istaknuti da je samo jedan fragment spaljen. Nažalost, nejasna stratigrafska slika ne dozvoljava da se ovi nalazi povežu sa životinjskim ostacima iz rimskog razdoblja i srednjeg vijeka.

## Rasprava

### *Ekonomija rimskog sela*

U skupu nalaza životinjskih ostataka iz rimskog sela određena su četiri taksona sisavaca: domaće govedo (*Bos taurus*), ovca/koza (*Ovis/Capra*), svinja (*Sus* sp.) i konj/magrac/mula (*Equus/Asinus*). Sličan sastav faune evidentiran je u naseljima na širem prostoru ovog dijela Rimskog carstva, primjerice u današnjoj Mađarskoj (Bökönyi 1974: 36) i Sloveniji (Toškan, Dirjec 2012), kao i luksuznim vilama na Jadranu (Brajković, Paunović 2001). Nedostatak drugih vrsta koje su inače potvrđene na drugim nalazištima (npr. perad) vjerojatno je rezultat ekstremnih uvjeta kiselosti u tlu.

Najbrojniji su ostaci goveda (51,7 % od taksonomski odredivih ostataka; Tab. 5) što ukazuje na ekonomsku važnost vrste u lokalnoj ruralnoj zajednici. Ostaci su vrlo fragmentirani i anatomske selektivnosti (Tab. 7) pa se ne može raspravljati o veličini i izgledu goveda, kao i o načinima njihova iskorištavanja (meso, mlijeko, radna snaga). Ali se može pretpostaviti da je, s obzirom na tjelesnu masu samih životinja, konzumiranje govedine bilo važan izvor mesnih proteina stanovnika ovog rimskog sela, bez obzira što su Rimljani držali goveda uglavnom radi sekundarnih proizvoda (Alcock 2006). Inače, prema dobno odredivim zubima, sva su goveda bila adulta.

Druga najvažnija životinja u rimskom naselju na Virovitici Kiškorijski jug bila je ovca i/ili koza (*Ovis/Capra*; 34,5 % od taksonomski odredivih ostataka; Tab. 5). Iako su ostaci jako oštećeni i kao takvi nedostadni za specifičnu odredbu, jednoj mandibuli sa zubima određena je pripadnost kozi dok je posredno pretpostavljeno i postojanje ovce prema nalazu željezne češagije za vunu (kompleks 2). Temeljem skromnih nalaza može se reći da su obje vrste bile prisutne u ovom selu, ali se o točnom načinu njihova iskorištavanja može samo nagađati. Kako su ovčje i kozje mlijeko te sir, bili jako cijenjeni u rimsko vrijeme, o čemu svjedoče brojni izvori (Ožanić Roguljić 2011), može se pretpostaviti da su ove životinje držane i za mužnju i radi mesa, dok ranije spo-

ficiently preserved for measurements in order to identify them to specific genus and/or species.

A pig (*Sus* sp.; Tab. 5, 7) is represented by a fragment of mandible with teeth ( $M_1$ ,  $M_2$ ). Based on occlusal wear it can be assumed that the animal was between one and two years old at the age of death, while small size indicate it was possibly a domestic pig (*Sus domesticus*).

A single fragment of an indeterminate lower molar is the only sheep and/or goat remain (*Ovis/Capra*) found in the out of context assemblage (Tab. 5, 7).

SU 504 revealed the largest number of animal remains of all stratigraphically questionable contexts. Overall, these remains are far better preserved in comparison to those from the Roman period and Middle Ages, and stand out by having a much better representation of skeletal elements. Furthermore, it is worth pointing out that only one fragment is burnt. Unfortunately, unclear stratigraphy does not allow to relate these material with the Roman period and medieval assemblages.

## Discussion

### *The economy of the Roman village*

The Roman period assemblage include the four identified mammalian taxa: domestic cattle (*Bos taurus*), sheep/goat (*Ovis/Capra*), pig (*Sus* sp.) and horse/ass/mule (*Equus/Asinus*). A similar taxonomic composition of fauna is recorded in settlements throughout this part of the Roman Empire, for instance in today's Hungary (Bökönyi 1974: 36) and Slovenia (Toškan, Dirjec 2012), as well as in luxury villas on the Adriatic coast (Brajković, Paunović 2001). The lack of other taxa that are otherwise common at the other sites (e.g. fowl) probably reflects extreme acidity in the soil.

The most numerous are the remains of cattle (51.7 % of NISP identified to taxa; Tab. 5), indicating the economic significance of this species to the local rural community. These remains are very fragmented and represent only a few anatomical elements (Tab. 7), and one cannot argue about the size and appearance of that cattle, as well as the ways of its use (meat, milk, draught). But it can be assumed that, based on their sheer size, consumption of beef was an important source of meat protein to the inhabitants of this Roman village, regardless the fact that cattle was used primarily for their secondary products (Alcock 2006). Anyway, all the cattle were adult based on the agreeable teeth.

The second most important animal in the Roman village of Virovitica Kiškorijski south was a sheep and/or goat (*Ovis/Capra*; 34.5 % of NISP identified to taxa; Tab. 5). Although the remains are badly damaged and as such insufficiently preserved to be identified to species, a single mandible with teeth is identified as a goat while the iron curry comb for wool (complex 2) is an indirect evidence for the presence of sheep. Based on these sparse finds it can be said that both species were present in this village, but the exact mode of their exploitation can only be speculated. Since both sheep and goat milk and cheese were very



menuti nalaz željezne češagije indicira i na iskorištavanje radi vune.

Skromni ostaci svinje samo indiciraju prisutnost vrste (vjerojatno domaća svinja), koja je sigurno bila držana primarno radi mesa.

Fragmentirane dentalne ostatke ekvida nije moguće generički odrediti čime ostaje otvoreno pitanje radi li se o ostacima konja (*Equus*), magarca (*Asinus*) ili možda mule. Sve tri životinje prisutne su u Europi tijekom rimskog razdoblja (Bökönyi 1974; Kron 2002; Peters 1998; Riedel 1996), a sam konj pronađen je u rimskim naseljima u široj okolici (npr. Toškan, Dirjec 2012). Općenito se smatra da Rimljani nisu jeli konjsko meso te se ono smatralo svojevrsnim tabuom (Alcock 2006), ali su zabilježeni rijetki slučajevi gdje je lokalno romanizirano stanovništvo u provincijama povremeno ipak konzumiralo konjsko meso (Groot 2008: 19; Lauwerier 2004: 71). Nažalost, fragmentirani zubi jedino su što je ostalo od ove životinje pa je moguće samo ustanoviti prisustvo najmanje jednog neodredivog ekvida u ovom rimskom selu.

#### *Ekonomija ranosrednjovjekovnog sela*

Životinjski ostaci izrazito su malobrojni (Tab. 5), što ne iznenađuje, s obzirom na općenito znatno manji broj srednjovjekovnih cjelina na položaju Virovitica Kiškoriya jug, kao i na izrazitu kiselost tla. Određena su samo dva taksona sisavaca: domaće govedo (*Bos taurus*) i ovca/koza (*Ovis/Capra*), koji su uobičajeni u istovremenim sastavima faune na širem prostoru (Bökönyi 1974; Grgurić 2011; Gugo Rumštajn et al. 2009; Kužir, Trbojević Vukičević 2004; Radović 2012). Usporedbom s navedenim objavljenim analizama srednjovjekovnih skupova nalaza životinjskih ostataka može se samo nagađati da su u ovom srednjovjekovnom selu bile prisutne i druge životinje poput svinje i konja. Nažalost, manjak materijala ne ostavlja prostora za detaljnije rasprave.

#### **Zaključak**

Analiza životinjskih ostataka sakupljenih na položaju Virovitica Kiškoriya Jug rezultirala je zanimljivim rezultatima, te potvrdila vrijednost i nužnost arheozooloških analiza čak i ovako skromnih skupova nalaza životinjskih ostataka.

Prehrambene navike stanovnika ovog rimskog sela (od 2. do sredine 5. st.) nisu se razlikovale od ostalih istovremenih na prostoru rimske provincije Panonije i šire.<sup>2</sup> Najbrojniji su ostaci domaćeg goveda i ovce/koze, dok sporadični nalazi neodredivog ekvida (konj/magarac/mula) i svinje samo ukazuju na prisustvo vrsti. Životinje su vjerojatno držane radi mesa i za mužnju te korištene kao radna snaga, iako se ova pretpostavka ne temelji na arheozoološkim dokazima već na povijesnim izvorima i objavljenim faunskim analizama s drugih istovremenih

appreciated in Roman times, as evidenced by numerous sources (Ožanić Roguljić 2011), it can be assumed that these animals were kept for both milking and the meat, while the iron curry comb mentioned earlier in the text also implies the wool production.

Scarce pig remains only indicate the presence of species (probably domestic pig), most likely kept for its meat.

It is not possible to identify fragmented equid teeth to species, leaving it open to speculations whether they belong to a horse (*Equus*), ass (*Asinus*) or perhaps mule. All three of them were present in Europe during the Roman period (Bökönyi 1974; Kron 2002; Peters 1998; Riedel 1996), and horse itself is evidenced in the Roman settlements in the wider region (e.g. Toškan, Dirjec 2012). It is generally considered that Romans did not eat horse meat and that it was considered as a taboo (Alcock 2006), although there are some rare exceptions to that rule where local Romanised population in provinces did occasionally eat horse meat (Groot 2008: 19; Lauwerier 2004: 71). Unfortunately, all that remained from this animal are fragmented teeth, only as evidence of the presence of at least one indeterminate equid in this Roman village.

#### *The economy of the medieval village*

Animal remains are very few in number (Tab. 5), which is not surprising considering generally much lower frequency of medieval contexts at the site of Virovitica Kiškoriya south, as well as extreme soil acidity. Only two mammalian taxa are identified: domestic cattle (*Bos taurus*) and sheep/goat (*Ovis/Capra*), both common at the contemporaneous faunal assemblages in the wider area (Bökönyi 1974; Grgurić 2011; Gugo Rumštajn et al. 2009; Kužir, Trbojević Vukičević 2004; Radović 2012). Through comparison with the above mentioned published faunal analyses of medieval assemblages, one can only speculate about the presence of other animals such as pigs and horses, in this medieval village. However, lack of material leaves no room for further discussion.

#### **Conclusion**

The analysis of animal remains collected at the site of Virovitica Kiškoriya South yielded interesting results, and confirmed the value and necessity of archaeozoological studies of even modest faunal assemblages, such as this one.

Dietary habits of the inhabitants of this Roman village (between the 2<sup>nd</sup> and the mid-5<sup>th</sup> century) did not differ from other contemporaneous people living in the Roman province of Pannonia and beyond.<sup>2</sup> The most numerous are the remains of domestic cattle and sheep/goat, while sporadic finds of an indeterminate equid (horse/ass/mule) and a pig only indicate the presence of species. Animals were probably kept for meat and milk as well as for draught, although this assumption is not based on archaeozoological evidences but is rather drawn from historical

2 Usporedi sa zaključkom u poglavlju 6.3.

2 Compare with the conclusion of the chapter 6.3.



nalazišta. Na temeljima nekadašnjeg rimskog naselja, razvilo se ranosrednjovjekovno selo (od kraja 8. do kraja 10. st.) u kojem su držana domaća goveda i ovce/koze a vjerojatno i druge domaće životinje.

Iako skromni, arheozoološki nalazi potvrđuju dosadašnje pretpostavke temeljene na podacima iz susjednih područja i povijesnih izvora. Oba sela, rimsko i ranosrednjovjekovno, tipični su predstavnici seoskih zajednica na ovom prostoru čije se gospodarstvo između ostalog temeljilo na stočarstvu.

sources and published faunal analyses of other contemporaneous sites. On the grounds of the former Roman settlement, an early medieval village was formed (between the late 8<sup>th</sup> and the late 10<sup>th</sup> century), maintaining the tradition of keeping cattle and sheep/goats, and probably other domestic animals, too.

Although modest, faunal remains confirm previous assumptions based on data from the neighbouring areas and historical sources. Both villages, Roman period and early medieval, represent typical rural communities in those periods of this region whose economy was based on animal husbandry, among other things.

## Biljni ostaci iz antičkog i srednjovjekovnog naselja na lokalitetu Virovitica Kiškorija Jug

### *Plant remains from the Roman and early medieval settlement at the site Virovitica Kiškorija South*

Renata Šoštarić

#### Uvod

Lokalitet Virovitica Kiškorija jug nalazi se između sela Korija i zapadnog ulaza u grad Viroviticu, južno od podravске magistrale, u njejoj neposrednoj blizini (17°22' E, 45°50' N). Istražen je 2005. godine kada su provedena zaštitna arheološka istraživanja na trasi obilaznice grada Virovitice, a istraživanje je proveo Institut za arheologiju, Zagreb.

Pronađeni su ostaci naselja smješteni na dva uzvišena položaja u nizinskom području uz vodotok Ođenica. Najveći dio od 1150 otkrivenih objekata pripada antičkom ruralnom naselju iz razdoblja od 2. do sredine 5. stoljeća (Jelinčić 2006a; 2006b; 2007a), dok 27 objekata, izdvojenih među antičkim ostacima, predstavljaju tragove ranosrednjovjekovnog naselja iz razdoblja od kraja 8. do 10. stoljeća (Sekelj Ivančan, Tkalčec 2008; 2010).

Tijekom arheoloških istraživanja arheolozi su uzimali arheobotaničke uzorke (uglavnom volumena od pet litara sedimenta) iz različitih stratigrafskih jedinica, flotirali ih preko mreža veličine 1 i 0,5 odnosno 0,3 milimetara, te izdvojene frakcije dostavljali na analizu u Botanički zavod Prirodoslovno-matematičkog fakulteta u Zagrebu.

Biljni materijal izdvojen je i identificiran uz pomoć binokularne lupe, literature (Cappers et al. 2006; Jacomet 2010; Kohler-Schneider 2001a; 2001b) i komparativne karpološke zbirke (karpološka zbirka Botaničkog zavoda PMF-a, Zagreb, u osnivanju). Biljni ostaci pohranjeni su u Botaničkom zavodu PMF-a, Zagreb, i dostupni su na uvid.

Analizirano je ukupno 99 arheobotaničkih uzoraka (pojedine frakcije istog uzorka objedinjene su i vode se pod jednim, istim brojem) i izdvojena su ukupno 953 biljna makrofosila. Od ukupnog broja nađenih makrofosila, 82% čine karbonizirani, a 18% nekarbonizirani biljni ostaci. Identificirano je 93% nalaza.

Od 99 analiziranih uzoraka njih 49 nije sadržavalo biljne makrofosile, izuzev različitih količina recentnog korijenja i sitnih fragmenata karboniziranog drva, te, samo iznimno, ostatke kostiju, keramike i drugih recentnih biljnih dijelova (nekarbonizirani fragmenti stabljike). Od 50 uzoraka koji su sadržavali biljne ostatke, 38 uzoraka s ukupno 804 nađena makrofosila potječe iz razdoblja antike (Tab. 8), a 12 uzo-

#### Introduction

Virovitica Kiškorija south site is located between the Korija village and the western entrance to the city of Virovitica, south of Podravina highway, in its immediate vicinity (17° 22' E, 45° 50' N). The site was explored in 2005, when rescue archaeological excavations were conducted by the Institute of Archaeology, Zagreb, along the route of the Virovitice bypass.

The ruins of the village were found, located on two elevated positions in the lowland area along the watercourse of Ođenica. The largest number of the 1150 objects discovered make part of an ancient rural village dating from the 2<sup>nd</sup> to the mid-5<sup>th</sup> century (Jelinčić 2006a; 2006b; 2007a), while 27 facilities, distinguished among the ancient remains, present traces of early medieval settlement dating from the late 8<sup>th</sup> to the 10<sup>th</sup> century (Sekelj Ivančan, Tkalčec 2008; 2010).

During the archaeological excavations, archaeologists collected archaeobotanical samples (usually five litres of sediment) from different stratigraphic units, and isolated fractions through the net size 1, 0.5 and 0.3 millimetres, which were then submitted for analysis to the Department of Botany, Faculty of Science in Zagreb.

The plant material was isolated and identified using binocular magnifier, literature (Cappers et al. 2006; Jacomet 2010; Kohler-Schneider 2001a; 2001b) and comparative carpological collections (Carpological Collection of the Department of Botany, Faculty of Science, Zagreb, in formation). Plant remains are stored in the Department of Botany, Faculty of Science, Zagreb, and are available for review.

A total of 99 archaeobotanical samples had been analyzed (individual fractions of the same sample were merged and were marked with the same number) and a total of 953 plant macrofossils was distinguished. Of all macrofossils found, 82% were carbonized, and 18% non-carbonized plant remains. Among all findings, 93% of them were identified.

Following the analysis of 99 samples, it was determined that 49 samples did not contain plant macrofossils, only different amounts of recent roots and tiny fragments of carbonized wood, and, exceptionally, the remains of bones, pottery and other recent plant parts (non-carbonized stem segments). By analysing 50 samples containing plant





raka s ukupno 149 makrofosila potječe iz srednjeg vijeka (Tab. 9).

Nekarbonizirani biljni ostaci koji u ovom kontekstu predstavljaju recentnu kontaminaciju, prikazani su u tablicama (Tab. 8 i 9), ali nisu korišteni u tumačenju i rekonstrukciji nalaza.

### Antika

Antički dio lokaliteta datira se od početka 2. do početka 5. stoljeća, a najbrojniji su objekti i nalazi iz prijelaza 3. u 4. stoljeće (Tab. 8). Brojem karboniziranih biljnih nalaza (515 makrofosila, 78 %) najbogatija je stratigrafska jedinica SJ 630/631 iz koje su uzeta tri uzorka, a potječu iz jedne od peći za pripremu hrane kompleksa 4 (Šošćarić et al. u tisku) Bitno manje nalaza potječe iz SJ 404/405 (61 makrofosil, 9 %), samo dva uzorka, koji predstavljaju ostatke objekta u kompleksu 4, dok ostale stratigrafske jedinice imaju vrlo malo karboniziranih nalaza ili ih uopće nemaju (sl. 207).

Najveći dio, tj. 93 % karboniziranih biljnih nalaza iz razdoblja antike pripada različitim vrstama žitarica. Nađeni su ječam (*Hordeum vulgare*), obična, krušna pšenica (*Triticum aestivum*), pravi pir (*T. spelta*), proso (*Panicum miliaceum*), raž (*Secale cereale*) i klipasti muhar (*Setaria italica*), te dosta velika količina karboniziranog pšena (*Cerealialia*) koje sigurno pripada kultiviranim žitaricama krupnog zrna, (*Triticum/Hordeum/Secale/Avena*), ali ostatke nije bilo moguće preciznije determinirati. Količinskim udjelom najzastupljenije je proso, zatim *Cerealialia*-žitarice, među kojima i ječam, dok su ostale svojte žitarica prisutne u puno manjem broju (Sl. 208). Pratećih korova gotovo da nema, nađeni su samo kukulj (*Agrostemma githago*) i kiseličasti dvornik (*Polygonum lapathifolium*), a čine svega 0,3 % udjela nalaza. Od

312

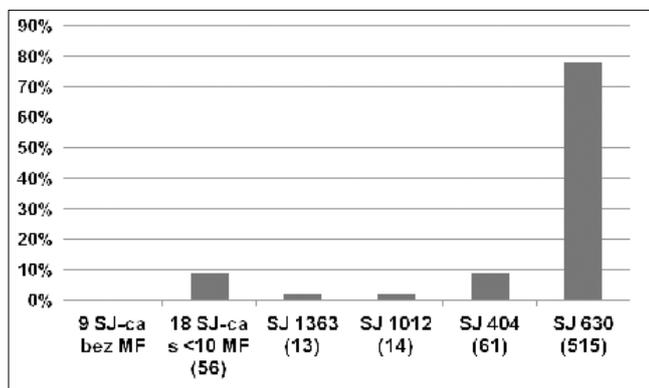

Sl. 207 Virovitica Kiškoriya jug, rimsko razdoblje—grafički prikaz udjela (ukupno broj / u zagradi / i postotak) nađenih karboniziranih biljnih ostataka po pojedinim stratigrafskim jedinicama (SJ) s brojem nalaza većim od 10 nalaza, te objedinjenim stratigrafskim jedinicama s brojem nalaza manjim od 10 i bez nalaza

Fig. 207 Virovitica Kiškoriya south, Antiquity—a graphical representation of the share (total / in parentheses / and percentage) of discovered carbonized plant remains in different stratigraphic units (SU=SJ) containing more than 10 finds, and integrated stratigraphic units in which a number of finds is less than 10 or there are none

remains, it was determined that 38 samples with a total of 804 macrofossils found, originated from Antiquity (Tab. 8), and 12 samples with a total of 149 macrofossils dated from the Middle Ages (Tab. 9).

Non-carbonized plant remains which in this context represent the recent contamination, are shown in tables (Tab. 8 and 9), but were not used in the interpretation and reconstruction of the findings.

### Antiquity

The ancient part of the site dates from the early 2<sup>nd</sup> to the early 5<sup>th</sup> century, and the most numerous are finds dated to the transition from the 3<sup>rd</sup> to the 4<sup>th</sup> century (Tab. 8). The greatest number of carbonized plant finds (515 macrofossils, 78 %) was found within the stratigraphic unit SU 630/631 from which three samples, that originated from one of the kilns used for food preparation in complex 4, were taken (Šošćarić et al. in press). A much lower number of findings came from SU 404/405 (61 macrofossils, 9 %), that is, only two samples, which represent the remains of the object in complex 4, while the other stratigraphic units contain very little or none of the carbonized findings (fig. 207).

The largest part, i.e. 93% of carbonized plant finds from Antiquity belongs to different types of grains. Among the finds there was barley (*Hordeum vulgare*), bread wheat (*Triticum aestivum*), spelt (*T. spelta*), common millet (*Panicum miliaceum*), rye (*Secale cereale*) and foxtail millet (*Setaria italica*) and a fairly large amount of carbonised cereals (*Cerealialia*) which certainly can be defined as cultivated large-grained grains (*Triticum / Hordeum / Secale / Avena*). It was not possible to determine the rest of the finds accurately. Millet dominates in quantity, followed by *Cerealialia*-grains including barley, while other species of grain are present in much smaller quantities (Fig. 208). Accompanying weeds are almost not present, and only corn-cockle (*Agrostemma githago*) and pale persicaria (*Polygonum lapathifolium*) were found, which makes up only 0.3 % of the findings.

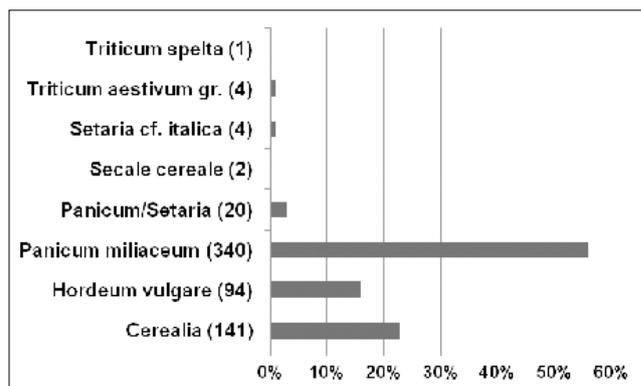

Sl. 208 Virovitica Kiškoriya jug, rimsko razdoblje—grafički prikaz udjela (ukupno broj / u zagradi / i postotak) karboniziranih ostataka različitih tipova žitarica (u ukupan broj nađenih makrofosila uključene i cf.-svojte)

Fig. 208 Virovitica Kiškoriya south, Antiquity—a graphical representation of the share (total / in parentheses / and percentage) of carbonized remains of various types of grains (in the total number of macrofossils found, cf-species are also included)



ostalnih kultiviranih vrsta nađena je vrlo mala količina karboniziranog boba (*Vicia faba*, 1 %) i šljiva (koštica s osušenim usplođem, *Prunus domestica*, 0,2 %), a od samoniklog korisnog bilja tek vrlo mala količina kupina (*Rubus fruticosus* agg., 0,3 %).

Kako se radi o ostacima antičkog ruralnog naselja, najvjerojatnije su se različiti tipovi žitarica, nađeni u uzorcima, uzgajali u široj okolini naselja. S obzirom na to da se radi o vrlo čistom uzorku, odn. da nedostaju pljeve i veća količina ostataka korova, vjerojatno su žitarice bile obrađene, pročišćene i pohranjene u kućna skladišta, spremne za lokalnu upotrebu, tj. pripremanje hrane, i/ili trgovinu. Osim žitarica uzgajale su se i druge kulture. Od mahunarki je dokumentiran samo bob (*Vicia faba*), a od voća samo šljiva (*Prunus domestica*), no vrlo vjerojatno bilo je uzgajano više različitih kultura.

U antičko doba na području Dunava (Švicarska, južna Njemačka, Austrija) od žitarica dominiraju ječam (*Hordeum vulgare*), dvoznari i pravi pir (*Triticum dicoccum* i *T. spelta*), ali više-manje prevladava isti spektar žitarica kao i u predrimsko, keltsko doba, što znači da je vrlo važno i proso (*Panicum miliaceum*), te krušna pšenica (*Triticum aestivum*), koja se javlja u dosta velikim količinama, ali ne posvuda. Različite vrste mahunarki i dalje imaju velik značaj, kao i u predrimsko doba. Uz spomenute, iz ranijih razdoblja naslijeđene kulture, prisutan je i „rimski“ mediteranski utjecaj, pa se u sve većem broju pojavljuju uvozne biljke, prije svega smokva (*Ficus carica*), zatim datulja (*Phoenix dactylifera*), breskva (*Prunus persica*), papar (*Piper nigrum*), te čitav niz začinskog bilja, dok je vinova loza (*Vitis vinifera*) još uvijek rijetka (Küster 1991: 183–184).

Brojna arheobotanička istraživanja u Mađarskoj (Gyulai 2010) potvrđuju prisutnost i važnost različitih žitarica, prije svega pšenice, ječma i prosa, ali se u zamjetnim količinama pojavljuju raž (*Secale cereale*) i zob (*Avena sativa*), dok se od mahunarki ističu leća (*Lens culinaris*), grašak (*Pisum sativum*), lećasta grahorica (*Vicia ervilia*), te bob (*Vicia faba*). Vinova loza je, čini se, prema brojnosti nalaza, od drvenastih vočki u antičko doba imala najvažnije mjesto uz orah (*Juglans regia*) i u manjoj mjeri neke druge plodove, a od mediteranskih elemenata pojavljuje se badem (*Prunus dulcis*). Veliku važnost i dalje je imalo sakupljanje različitih samoniklih plodova, prije svega crne bazge (*Sambucus nigra*).

Na području jugoistočne Europe (Bosna i Hercegovina, Srbija, Bugarska, Makedonija i Grčka) kontinuirano su, od najstarijih razdoblja, važnost zadržale žitarice kao što su ječam, dvoznari i pravi pir, proso, te klipasti muhar (*Setaria italica*), uz krušnu pšenicu koja je tijekom željeznog doba postala glavna žitarica i zob koja se tada počela intenzivnije uzgajati. Kontinuirani značaj imaju i mahunarki poput leće, graška, boba i dr., te čitav niz drugih kultura – voća, povrća, začinskog bilja i uljarica (Kroll 1991: 167–168).

Za područje Hrvatske postoji dosta arheobotaničkih nalaza iz razdoblja antike, ali oni najvećim dijelom potječu

Among other cultivated species only a very small amount of carbonized broad beans (*Vicia faba*, 1 %) and plums (fruit stone with dried pericarp, *Prunus domestica*, 0.2 %) were found. Also a very small quantity of blackberries (*Rubus fruticosus* agg., 0.3 %) was found, which represent wild useful plants.

Since these are the remains of an ancient rural settlement, different types of grains, found within the samples, were probably grown in the wider area of the settlement. On account of this being a very pure sample, i.e. chaff and a greater amount of residual weeds are not present, grains were probably processed, purified and stored in the home storages, ready for local use, i.e., cooking, and/or trading. Besides the cereals, other cultures were grown too. As for the pulses, only broad beans (*Vicia faba*) were registered and as for the fruits, only plums (*Prunus domestica*). Nevertheless, it is very likely that also several other different cultures were cultivated.

In ancient times on the area of the Danube River (Switzerland, southern Germany, Austria), the dominating cereals were barley (*Hordeum vulgare*), emmer and spelt (*Triticum dicoccum* and *T. spelta*), but, more or less, the prevailing range of grains was the same as during the pre-Roman, Celtic era, which means that millet (*Panicum miliaceum*) and bread wheat (*Triticum aestivum*) which occur in quite large quantities, but not everywhere, were very important. Different types of pulses still had as great importance as in pre-Roman times. In addition to cultures inherited from earlier periods, the “Roman” Mediterranean influence has been detected, the number of imported plants was increasing, especially of figs (*Ficus carica*), the date palms (*Phoenix dactylifera*), peaches (*Prunus persica*), pepper (*Piper nigrum*) and different sorts of herbs, while the grapevine (*Vitis vinifera*) was still uncommon (Küster 1991: 183–184).

Numerous archaeobotanical studies in Hungary (Gyulai 2010) confirm the presence and importance of various grains, especially wheat, barley and millet, but rye (*Secale cereale*) and oats (*Avena sativa*) also appeared in noticeable quantities, while the pulses were represented by lentil (*Lens culinaris*), peas (*Pisum sativum*), bitter vetch (*Vicia ervilia*) and broad beans (*Vicia faba*). Taking into account the number of finds, grapevine was the most important of the fruit trees in ancient times, alongside walnut (*Juglans regia*) and, to a lesser extent, some other fruits. As for the Mediterranean elements, almond (*Prunus dulcis*) was found. Collecting various wild fruits, especially black elderberry (*Sambucus nigra*), was still very important.

Grains such as barley, emmer, spelt, millet and foxtail millet (*Setaria italica*) continuously remained important since the earliest periods, on the area of South Eastern Europe (Bosnia and Herzegovina, Serbia, Bulgaria, Macedonia and Greece), together with bread wheat which during the Iron Age became the primary cereal, and oat, which was more intensely cultivated from that time on. The importance of pulses such as lentils, peas, beans, etc., and of a number of other cultures – fruits, vegetables, herbs and oilseeds, is continuous (Kroll 1991: 167–168).



iz obalnog područja. Nalazima su najbogatiji lokaliteti nekadašnjih antičkih luka – uvala Verige na Velom Brijunu (Šošćarić, Küster 2001), Zaton kod Nina (Gluščević et al. 2006: 155–161) i Caska na otoku Pagu (Tillier 2012). Brojni odlično očuvani nekarbonizirani biljni ostaci iz pomorskih sedimenata odražavaju bogat i intenzivan uzgoj (i trgovinu) prije svega mediteranskih kultura – masline (*Olea europaea*), vinove loze, smokve i dr., te različitog voća, povrća i začinskog bilja. Žitarice (pšenica i proso) su na ovim lokalitetima dokumentirane tek u tragovima, dok mahunarke uopće nisu nađene, vjerojatno zbog uvjeta konzerviranja, no njihova je prisutnost i važnost potvrđena na obalnim kopnenim lokalitetima. U Danilu kod Šibenika nađena je veća količina karboniziranog ječma, obične pšenice, pravog pira i zobi (Šošćarić 2003: 130–133), a u Poreču prilično velika količina leće i malo žitarica, prije svega obične pšenice (Šošćarić, neobjavljeno).

Puno je manje arheobotaničkih nalaza iz kontinentalnog dijela Hrvatske. Ponešto se o poljodjelskim kulturama može indirektno saznati iz sadržaja antičkih grobova u Iloku i Šćitarjevu (Šošćarić et al. 2006). U njima su nađeni karbonizirani i nekarbonizirani ostaci različitih žitarica (*Hordeum vulgare*, *Triticum aestivum*, *T. dococum*, *T. monococum*, *T. spelta*, *Panicum miliaceum*), mahunarki (*Lens culinaris*, *Vicia ervilia*), voća i drugog bilja, koji odražavaju raznolikost poljodjelskih kultura, a nalazi smokve i masline pokazuju i prisutnost “rimskog” mediteranskog utjecaja. Slični “egzotični” elementi – smokva, datulja (*Phoenix dactilifera*), vjerojatno i čičimak (*Zizyphus jujuba*) nađeni su i u rimskim grobovima u Sloveniji (Šercelj 1990). Zanimljivo je za spomenuti i nekarbonizirane nalaze vinove loze (prilično velika količina u iločkom grobu, mala u Šćitarjevu) i crne bazge (Šošćarić et al. 2006). Zrele bobice crne bazge koristile su se za spravljanje vina i rakija, te za bojanje i poboljšavanje okusa vina (König 1993). Uzgoj vina u pannonском području dokumentiran je u drugoj polovici 3. stoljeća na obroncima Fruške gore, ali s obzirom na to da se za lokalnu rimsku aristokraciju vinu uvozilo (Zaninović 1976: 261), čini se da lokalno proizvedeno vino nije bilo osobite kvalitete, pa mu se vrlo vjerojatno dodavala crna bazga za poboljšanje/pojačavanje okusa.

Kako se radi o prvom velikom i sustavnom istraživanju ruralnog antičkog naselja na području Hrvatske, a i u bližim susjednim zemljama, ovo su prvi arheobotanički nalazi s ovakvog tipa lokaliteta i prvi pokušaji rekonstrukcije prehrane ruralnog antičkog stanovništva (Šošćarić et al. u tisku). Prema dostupnoj literaturi, jedini sličan lokalitet s kojim se nalazi mogu usporediti dolazi iz susjedne Mađarske (Torma 2007). U nalazima također dominiraju žitarice, od kojih polovica nalaza pripada običnoj pšenici, a zamjetan udio ima i ječam. Raž se pojavljuje u malim količinama, ali u gotovo svim uzorcima, pa autorica smatra da također ima važnu ulogu u zajednici, kao i u malim količinama nađene mahunarke (leća, grašak i lećasta gra-

In the area of Croatia there is a great number of archaeobotanical finds from Antiquity, but mostly they originate from the coastal areas. Most abundant in findings are the sites of ancient harbours – Verige bay on Veli Brijun (Šošćarić, Küster 2001), Zaton near Nin (Gluščević et al. 2006: 155–161) and Caska bay on the island of Pag (Tillier 2012). Numerous well preserved non-carbonised plant remains from marine sediments reflect the rich and intensive farming (and trade) primarily of the Mediterranean cultures – olives (*Olea europaea*), grapes, figs, and a variety of fruits, vegetables and herbs. Cereals (wheat and millet) have been documented only in traces in these sites, while pulses were not found, probably due to the conditions on the site, but their presence and importance was confirmed on the coastal sites. In Danilo near Šibenik a great amount of carbonized barley, bread wheat, spelt and oats (Šošćarić 2003: 130–133) was found, and in Poreč, a fairly large amount of lentil and some grain, primarily bread wheat (Šošćarić, unpublished).

There is much less archaeobotanical findings from the continental Croatia. Some details of the agriculture may indirectly be grasped from the content of ancient graves in Ilok and Šćitarjevo (Šošćarić et al. 2006). In those graves, carbonized and non-carbonized remains of various cereals (*Hordeum vulgare*, *Triticum aestivum*, *T. dococum*, *T. monococum*, *T. spelta*, *Panicum miliaceum*) were found, as well as pulses (*Lens culinaris*, *Vicia ervilia*), fruits and other plants, which reflect the diversity of agricultural cultures, while the findings of figs and olives indicate the presence of the “Roman” Mediterranean influences. Similar “exotic” elements - figs, dates (*Phoenix dactilifera*), perhaps also jujube (*Zizyphus jujuba*), were found in Roman graves in Slovenia (Šercelj 1990). It is interesting to mention the non-carbonized finds of grapevine (fairly large quantities in the Ilok grave, and a small quantity in Šćitarjevo) and black elderberry (Šošćarić et al. 2006). Ripe berries of black elderberry were used for the production of wines and spirits, as well as for colouring and flavouring of wine (König 1993). Growing of grapevine in the Pannonian region was documented in the second half of the 3<sup>rd</sup> century on the slopes of Fruška Gora, but considering the fact that the local Roman aristocracy imported wine (Zaninović 1976: 261), it seems that locally produced wine was not of particular quality so black elderberry was added in order to improve/enhance the flavour.

As this is the first large, systematic study of an ancient rural settlement on the Croatian territory and also in the neighbouring countries, these are the first archaeobotanical finds from such type of site and the first attempt of the reconstruction of the diet habits of ancient rural population (Šošćarić et al. in press). According to the available literature, the only similar site with comparable finds is the one in the neighbouring Hungary (Torma 2007). Among the findings grains also prevail; half of those are bread wheat, and a significant amount is barley. Rye occurs in small amounts, but in almost all samples, therefore the author believes that it has an important role in the community, as well as pulses which were found in small quantities



horica). Od nađenih voćaka najzastupljeniji su ostaci oraha.

Zajedničko ovim antičkim lokalitetima u Hrvatskoj i Mađarskoj je dominacija žitarica, prisutnost mahunarki, uzgajanih drvenastih voćaka i samoniklih plodova, te potpuno odsustvo "egzotičnih" mediteranskih elemenata, koji se pojavljuju u većim i bogatijim urbanim rimskim naseljima. To bi moglo ukazivati na zatvorenost i samodostatnost ruralnih antičkih zajednica.

### Srednji vijek

Datirani slojevi iz srednjeg vijeka uglavnom potječu iz starijeg horizonta I iz kraja 8.-9. stoljeća (Sekelj Ivančan, Tkalčec 2008; 2010) (Tab. 9). Najveći broj karboniziranih biljnih nalaza (93 makrofosila, 77%) sadrži stratigrafska jedinica SJ 1061 koja predstavlja ostatke krušne peći, dok ostale stratigrafske jedinice imaju bitno manje karboniziranih nalaza ili ih uopće nemaju (sl. 209).

Najveći dio, tj. 82 % karboniziranih biljnih nalaza iz srednjeg vijeka čine žitarice, a kada se izuzmu nedeterminirani biljni ostaci, onda žitarice iznose 96 % udjela i apsolutno dominiraju u uzorcima. Najveći dio čine ostaci kultiviranih žitarica koje nije bilo moguće preciznije determinirati (*Cerealia*, 72 %), zatim obična, krušna pšenica (*Triticum aestivum*, 20 %), dok se proso (*Panicum miliaceum*), pravi pir (*Triticum spelta*) i raž (*Secale cereale*) pojavljuju u vrlo malom broju (sl. 210). Uz žitarice, u uzorcima se pojavljuju primjese u tragovima i jedna deformirana sjemenka vinove loze (*Vitis vinifera*), što znači da je, slično antičkim uzorcima, nalaz žitarica vrlo čist. Vrlo vjerojatno su se i u srednjem vijeku žitarice uzgajale na širem području naselja, te koristile za lokalnu upotrebu i trgovinu, ali premalo je podataka na raspolaganju da bi se moglo reći nešto konkretnije i sigurnije o životu i poljodjelstvu srednjevjekovnog naselja.

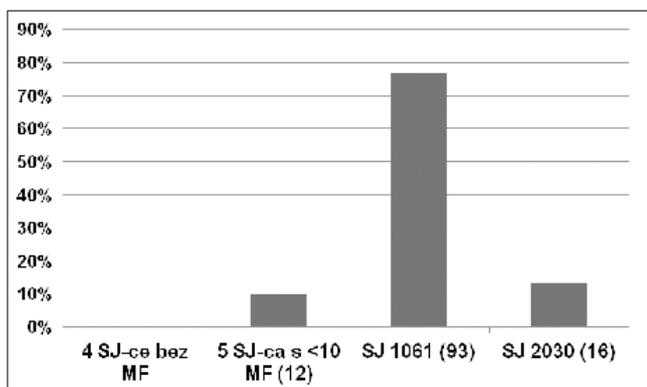

Sl. 209 Virovitica Kiškoriya jug, srednji vijek – grafički prikaz udjela (ukupan broj / u zagradi / i postotak) nađenih karboniziranih biljnih ostataka po pojedinim stratigrafskim jedinicama (SJ) s brojem nalaza većim od 10 nalaza, te objedinjenim stratigrafskim jedinicama s brojem nalaza manjim od 10 i bez nalaza

Fig. 209 Virovitica Kiškoriya south, Middle Ages – a graphical representation of the share (total / in parentheses / and percentage) of discovered carbonized plant remains in individual stratigraphic units (SU=SJ) with more than 10 finds, and integrated stratigraphic units in which a number of finds is less than 10 or there are none

(lentils, peas and bitter vetch). Walnuts prevail among the fruits found on the site.

What these ancient sites in Croatia and Hungary have in common is the dominance of grain, the presence of pulses, growing of fruit trees and wild fruits, and the complete absence of "exotic" Mediterranean elements, which appear in larger and wealthier urban Roman settlements. This could indicate tightness and self-sufficiency of rural ancient communities.

### Middle Ages

Layers dated to the Middle Ages originate mainly from the older horizon I, from the late 8<sup>th</sup> to the 9<sup>th</sup> century (Sekelj Ivančan, Tkalčec 2008; 2010) (Tab. 9). The largest number of carbonized plant findings (93 macrofossils, 77 %) is contained in the stratigraphic unit SU 1061, which represents the remains of a wood-fired brick kiln, while other stratigraphic units contain significantly lower number of carbonized findings or none at all (fig. 209).

The largest part, i.e. 82 % of carbonized plant finds from the Middle Ages, consists of cereals and, when indeterminate plant remains are excluded, cereals amount to 96 % and absolutely dominate amid samples. The largest part consists of the remains of cultivated grains that could not be accurately determined (*Cerealia*, 72 %), followed by bread wheat (*Triticum aestivum*, 20 %), while millet (*Panicum miliaceum*), spelt (*Triticum spelta*) and rye (*Secale cereale*) are present in very small amounts (fig. 210). In addition to cereals, impurities in traces and one deformed seed of grapevine (*Vitis vinifera*) appeared in samples, meaning that, like in samples from the Antiquity, grains that were found are very pure. Most probably, during the Middle Ages too, the cereals were grown in the wider area of the settlement, and used for local consumption and trade, but there is not enough data available to enable any more definite and more certain statement about life and agriculture in an medieval settlement.

The overview of archaeobotanical finds from the Middle

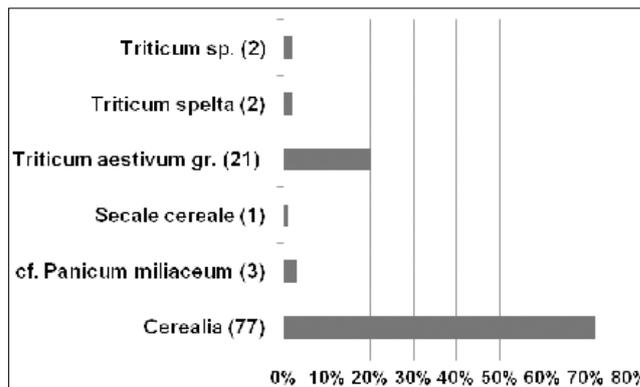

Sl. 210 Virovitica Kiškoriya jug, srednji vijek – grafički prikaz udjela (ukupan broj / u zagradi / i postotak) karboniziranih ostataka različitih tipova žitarica (u ukupan broj nađenih makrofosila uključene i cf.-svojtje)

Fig. 210 Virovitica Kiškoriya south, Middle Ages – a graphical representation of the share (total / in parentheses / and percentage) of carbonized remains of various types of grains (in the total number of macrofossils found, cf.-species are also included)



Pregled arheobotaničkih nalaza iz srednjeg vijeka na području Dunava (Švicarska, južna Njemačka, Austrija) (Küster 1991: 184–185), kao i u jugoistočnoj Europi (Bosna i Hercegovina, Srbija, Bugarska, Makedonija i Grčka) (Kroll 1991: 167–168), te malobrojni nalazi s područja Hrvatske (Šoštarić 2004, 107–115; 2006: 200–201) pokazuje veliku raznolikost i bogatstvo lokalnih poljodjelskih kultura, obogaćenih “uvoznim” mediteranskim proizvodima. S obzirom na povoljan geografski položaj i dokumentiranu razvijenu agrikulturu u ranijem, antičkom razdoblju, vjerojatno je i u srednjevjekovnoj fazi naselja agrikultura bila razvijena i puno raznolikija od skromnog spektra žitarica nađenog u uzorcima.

Ages on the Danube area (Switzerland, southern Germany, Austria) (Küster 1991: 184–185), as well as in South-Eastern Europe (Bosnia and Herzegovina, Serbia, Bulgaria, Macedonia and Greece) (Kroll 1991: 167–168), alongside with rare finds from the territory of Croatia (Šoštarić 2004, 107–115; 2006: 200–201) shows great diversity and richness of local farming cultures, enriched with “imported” Mediterranean products. Taking into consideration the advantageous geographical position and a developed agriculture noted in the earlier, Antique, period, the agriculture in the medieval settlement was probably advanced and a lot more diverse than a modest range of grains found in samples shows.

**TABLICA 8 I 9 TUMAČ KRATICA:**

SJ – stratigrafska jedinica, U – uzorak; K-Ž – kultivirane biljke – žitarice, K-M – kultivirane biljke – mahunarke, K-V – kultivirane biljke – voće, SK – samonikle korisne biljke, KR – korovne i/ili ruderalne biljke, K – karbonizirani biljni ostaci, NK – nekarbonizirani biljni ostaci.

**TABLE 8 AND 9 KEY TO ABBREVIATIONS:**

SU – stratigraphic unit, S – sample; Cu-Ce – cultivated plants – cereals, Cu-P – cultivated plants - pulses, Cu-F – cultivated plants – fruits, W – wild useful plants, WR – weeds and / or ruderal plants; C – carbonized plant remains, NC – non-carbonized plant remains.



SVOJTE:	BILJNI OSTACI:	EKOL. GRUPE:	K/NK:	3.-4. st.	3.-4. st.	3.-4. st.	3.-4. st.	3.-4. st.	3.-4. st.	3.-4. st.	3.-4. st.	3.-4. st.	3.-4. st.	3.-4. st.	3.-4. st.	3.-4. st.	3.-4. st.	3.-4. st.
<i>Agrostemma githago</i>	sjemenka	KR	K															
<i>Cerealia</i>	pšeno	K-Ž	K															
cf. <i>Cerealia</i>	fragm. pšena	K-Ž	K															
<i>Chenopodium album</i>	plodić	KR	NK	5	4													
<i>Chenopodium</i> sp.	(fragm.) plodića		NK															
<i>Chenopodium</i> cf. <i>polyspermum</i>	plodić	KR	NK															
cf. <i>Echinochloa crus-galli</i>	pšeno s pljevama	KR	NK															
<i>Hordeum vulgare</i>	pšeno	K-Ž	K	2														
cf. <i>Hordeum vulgare</i>	pšeno	K-Ž	K															
<i>Panicum miliaceum</i>	pšeno	K-Ž	K	2														
cf. <i>Panicum miliaceum</i>	pšeno	K-Ž	K	1														
<i>Panicum/Setaria</i> sp.	pšeno	K-Ž	K															
Poaceae	pšeno		K															
cf. Poaceae (cf. <i>Cerealia</i> )	fragm. stabljike		NK															
<i>Polycnemum arvense/majus</i>	plodić	KR	NK															
<i>Polygonum lapathifolium</i>	plodić	KR	NK	5	1													
<i>Prunus domestica</i>	koštica s osušenim usplođem	K-V	K	1														
<i>Rubus fruticosus</i> agg.	koštica	SK	K															
<i>Secale cereale</i>	pšeno	K-Ž	K															
<i>Setaria</i> cf. <i>italica</i>	pšeno	K-Ž	K															
<i>Setaria</i> sp.	pšeno		K															
cf. <i>Spergula arvensis</i>	sjemenka		K															
<i>Triticum aestivum</i> gr.	pšeno	K-Ž	K															
<i>Triticum spelta</i>	pšeno	K-Ž	K															
<i>Vicia faba</i>	sjemenka	K-M	K															
indet.			K+NK															
ukupno:			K+NK	0+1	1+10	1+0	1+0	0+1	0+1	1+4	1+0	1+0	2+2	8+8	0+1	5+0	2+0	0+5

Tablica 8 – I. dio. Virovitica Kiškorija jug – popis biljnih nalaza iz rimskog razdoblja





SVOJTE:	BILJNI OSTACI:	EKOL. GRUPE:	K/NK:	3.-4. st.	3.-4. st.	3.-4. st.	3.-4. st.	3.-4. st.	3.-4. st.	3.-4. st.	3.-4. st.	3.-4. st.	3.-4. st.	3.-4. st.	3.-4. st.	
<i>Agrostemma githago</i>	sjemenka	KR	K													
<i>Cerealia</i>	pšeno	K-Ž	K	1												
cf. <i>Cerealia</i>	fragm. pšena	K-Ž	K	1												
<i>Chenopodium album</i>	plodić	KR	NK		1											
<i>Chenopodium</i> sp.	(fragm.) plodića		NK		1											
<i>Chenopodium</i> cf. <i>polyspermum</i>	plodić	KR	NK													
cf. <i>Echinochloa crus-galli</i>	pšeno s pljevama	KR	NK		1											
<i>Hordeum vulgare</i>	pšeno	K-Ž	K													
cf. <i>Hordeum vulgare</i>	pšeno	K-Ž	K													
<i>Panicum miliaceum</i>	pšeno	K-Ž	K		2											
cf. <i>Panicum miliaceum</i>	pšeno	K-Ž	K													
<i>Panicum/Setaria</i> sp.	pšeno	K-Ž	K													
<i>Poaceae</i>	pšeno		K													
cf. <i>Poaceae</i> (cf. <i>Cerealia</i> )	fragm. stabljike		NK													
<i>Polycnemum arvense/majus</i>	plodić	KR	NK		1											
<i>Polygonum lapathifolium</i>	plodić	KR	NK		1											
<i>Prunus domestica</i>	koštica s osušenim usplođem	K-V	K													
<i>Rubus fruticosus</i> agg.	koštica	SK	K													
<i>Secale cereale</i>	pšeno	K-Ž	K													
<i>Setaria</i> cf. <i>italica</i>	pšeno	K-Ž	K													
<i>Setaria</i> sp.	pšeno		K													
cf. <i>Spergularia arvensis</i>	sjemenka		K													
<i>Triticum aestivum</i> gr.	pšeno	K-Ž	K		1											
<i>Triticum spelta</i>	pšeno	K-Ž	K													
<i>Vicia faba</i>	sjemenka	K-M	K													
indet.			K+NK													
ukupno:			K+NK													
				2+0	0+1	1+14	0+2	6+4	1+0	2+4	0+9	2+3	0+7	7+0	2+0	8+0
																54+0

Tablica 8 – II. dio. Virovitička Kiškorijska jug – popis biljnih nalaza iz rimskog razdoblja





TAXA:	PLAN REMAINS:	ECOLOGICAL GROUPS:	C/NC:	SU 035, 3 <sup>rd</sup> -4 <sup>th</sup> century	SU 052, 3 <sup>rd</sup> -4 <sup>th</sup> century	SU 076, 3 <sup>rd</sup> -4 <sup>th</sup> century	SU 106, 3 <sup>rd</sup> -4 <sup>th</sup> century	SU 190, ?	SU 194, 3 <sup>rd</sup> -4 <sup>th</sup> century	SU 196, 3 <sup>rd</sup> -4 <sup>th</sup> century	SU 198, 3 <sup>rd</sup> -4 <sup>th</sup> century	SU 360, 3 <sup>rd</sup> -4 <sup>th</sup> century	SU 404, 3 <sup>rd</sup> -4 <sup>th</sup> century	SU 404, 3 <sup>rd</sup> -4 <sup>th</sup> century	SU 118, 3 <sup>rd</sup> -4 <sup>th</sup> century	SU 404, 3 <sup>rd</sup> -4 <sup>th</sup> century	SU 128, 3 <sup>rd</sup> -4 <sup>th</sup> century	
<i>Agrostemma githago</i>	seed	WR	C/NC:															
<i>Cerealia</i>	grain	Cu-Ce	C	1					1		2				5		44	
cf. <i>Cerealia</i>	grain segment	Cu-Ce	C	1				1										
<i>Chenopodium album</i>	fruit	WR	NC					1	2	6	2							
<i>Chenopodium</i> sp.	fruit segment		NC			2	2											
<i>Chenopodium</i> cf. <i>polyspermum</i>	fruit	WR	NC															
cf. <i>Echinochloa crus-galli</i>	grain with chaff	WR	NC					1										
<i>Hordeum vulgare</i>	grain	Cu-Ce	C															
cf. <i>Hordeum vulgare</i>	grain	Cu-Ce	C															
<i>Panicum miliaceum</i>	grain	Cu-Ce	C					2										
cf. <i>Panicum miliaceum</i>	grain	Cu-Ce	C															
<i>Panicum/Setaria</i> sp.	grain	Cu-Ce	C															
<i>Poaceae</i>	grain	Cu-Ce	C															
cf. <i>Poaceae</i> (cf. <i>Cerealia</i> )	stem segment		NC															
<i>Polycnemum arvense/majus</i>	fruit	WR	NC					1	2	1	1							
<i>Polygonum lapathifolium</i>	fruit	WR	NC		1	3				2		7						
<i>Prunus domestica</i>	fruit stone with dried pericarp	Cu-F	C															
<i>Rubus fruticosus</i> agg.	fruit stone	W	C															
<i>Secale cereale</i>	grain	Cu-Ce	C															
<i>Setaria</i> cf. <i>italica</i>	grain	Cu-Ce	C															
<i>Setaria</i> sp.	grain	Cu-Ce	C															
cf. <i>Spergula arvensis</i>	seed	Cu-Ce	C															
<i>Triticum aestivum</i> gr.	grain	Cu-Ce	C			1												2
<i>Triticum spelta</i>	grain	Cu-Ce	C															
<i>Vicia faba</i>	seed	Cu-P	C															
indet.			C+NC					3+1	1+0									8+0
in total:			C+NC	2+0	0+1	1+14	0+2	6+4	2+4	0+9	2+3	0+7			2+0	7+0		54+0

Table 8 – part II Virovitica Kiškorijai south – a list of plant finds from the Antiquity



SVOJITE:	BILJNI OSTACI:	EKOL. GRUPE:	K/NK:	U 179	SJ 499,	U 149	SJ 509,	U 161	SJ 510,	U 160	SJ 630,	U 195	SJ 630,	U 195	SJ 630,	U 201	SJ 642,	U 198	SJ 802,	U 207	SJ 966,	Kraj 1.-2. st.	SJ 1010,	U 229	
<i>Agrostemma githago</i>	sjemenka	KR	K								1														
<i>Cerealia</i>	pšeno	K-Ž	K								20														
cf. <i>Cerealia</i>	fragm. pšena	K-Ž	K																			1			
<i>Chenopodium album</i>	plodić	KR	NK																						
<i>Chenopodium</i> sp.	(fragm.) plodića		NK																						
<i>Chenopodium</i> cf. <i>polyspermum</i>	plodić	KR	NK																						
cf. <i>Echinochloa crus-galli</i>	pšeno s pljevama	KR	NK																						
<i>Hordeum vulgare</i>	pšeno	K-Ž	K								59														
cf. <i>Hordeum vulgare</i>	pšeno	K-Ž	K																						
<i>Panicum miliaceum</i>	pšeno	K-Ž	K								92														
cf. <i>Panicum miliaceum</i>	pšeno	K-Ž	K								40														
<i>Panicum/Setaria</i> sp.	pšeno	K-Ž	K								20														
<i>Poaceae</i>	pšeno		K																						
cf. <i>Poaceae</i> (cf. <i>Cerealia</i> )	fragm. stabljike		NK																						
<i>Polycnemum arvense/majus</i>	plodić	KR	NK																						
<i>Polygonum lapathifolium</i>	plodić	KR	NK																						
<i>Prunus domestica</i>	koštica s osušenim usplođem	K-V	K																						
<i>Rubus fruticosus</i> agg.	koštica	SK	K																						
<i>Secale cereale</i>	pšeno	K-Ž	K																						
<i>Setaria</i> cf. <i>italica</i>	pšeno	K-Ž	K																						
<i>Setaria</i> sp.	pšeno		K																						
cf. <i>Spergula arvensis</i>	sjemenka		K																						
<i>Triticum aestivum</i> gr.	pšeno	K-Ž	K																						
<i>Triticum spelta</i>	pšeno	K-Ž	K																						
<i>Vicia faba</i>	sjemenka	K-M	K																						
indet.			K	6																					
ukupno:			K+NK	6+0	2+0	4+0	0+1	3+0	3+0	195+1	2+1	1+0	75+0	245+0	9+0	2+1	2+0	2+1	2+0	1+24	0+4	1+5			

Tablica 8 – III. dio. Virovitica Kiškoriya jug – popis bijlnih nalaza iz rimskog razdoblja



TAXA:	PLANT REMAINS	ECOLOGICAL GOUPS:	C/ NC:	SU 427, S 179	SU 499, 3 <sup>rd</sup> -4 <sup>th</sup> S 149	SU 509, 3 <sup>rd</sup> -4 <sup>th</sup> S 161	SU 510, 3 <sup>rd</sup> -4 <sup>th</sup> S 160	SU 630, 3 <sup>rd</sup> -4 <sup>th</sup> S 195	SU 630, 3 <sup>rd</sup> -4 <sup>th</sup> S 195	SU 642, 3 <sup>rd</sup> -4 <sup>th</sup> S 198	SU 802, Beg. 3 <sup>rd</sup> S 207	SU 966, End 1 <sup>st</sup> - 2 <sup>nd</sup> Cen- tury S 242	SU 1010, 2 <sup>nd</sup> -3 <sup>rd</sup> century S 229
<i>Agrostemma githago</i>	seed	WR	C							1			
<i>Cerealia</i>	grain	Cu-Ce	C					30		20			
cf. <i>Cerealia</i>	grain segment	Cu-Ce	C					9				1	
<i>Chenopodium album</i>	fruit	WR	NC							1		29	
<i>Chenopodium</i> sp.	fruit segment		NC										
<i>Chenopodium</i> cf. <i>polyspernum</i>	fruit	WR	NC										
cf. <i>Echinochloa crus-galli</i>	grain with chaff	WR	NC										
<i>Hordeum vulgare</i>	grain	Cu-Ce	C					14		59			
cf. <i>Hordeum vulgare</i>	grain	Cu-Ce	C					6					
<i>Panicum miliaceum</i>	grain	Cu-Ce	C					156		92			
cf. <i>Panicum miliaceum</i>	grain	Cu-Ce	C					8		40			
<i>Panicum/Setaria</i> sp.	grain	Cu-Ce	C							20			
Poaceae	grain		C										
cf. Poaceae (cf. <i>Cerealia</i> )	stem segment		NC									5	1
<i>Polycnemum arvense/majus</i>	fruit	WR	NC										
<i>Polygonum lapathifolium</i>	fruit	WR	NC										
<i>Prunus domestica</i>	fruit stone with dried pericarp	Cu-F	C										
<i>Rubus fruticosus</i> agg.	fruit stone	W	C										
Secale cereale	grain	Cu-Ce	C							1			
<i>Setaria</i> cf. <i>italica</i>	grain	Cu-Ce	C							4			
<i>Setaria</i> sp.	grain		C										1
cf. <i>Spergula arvensis</i>	seed		C										
<i>Triticum aestivum</i> gr.	grain	Cu-Ce	C										
<i>Triticum spelta</i>	grain	Cu-Ce	C										
<i>Vicia faba</i>	seed	Cu-P	C										
indet.			C+NC	6	2+0					9+0			0+4
in total:			C+NC	6+0	4+0	0+1	3+0	195+1	2+1	245+0	2+1	1+24	1+5

Table 8 – part III Virovitica Kiškorijski south – a list of plant finds from the Antiquity



SVOJTE:	BILJNI OSTACI:	EKOL. GRUPE:	K/NK:	?	2.-3. st. ?	poč. 5. st.	?	2. st. ?	?	ukupno, K+NK:
<i>Agrostemma githago</i>	sjemenka	KR	K							1+0
<i>Cerealia</i>	pšeno	K-Ž	K	11						123+0
cf. <i>Cerealia</i>	fragm. pšena	K-Ž	K			13				18+0
<i>Chenopodium album</i>	plodić	KR	NK	1			19	5	1	0+93
<i>Chenopodium</i> sp.	(fragm.) plodića		NK							0+4
<i>Chenopodium</i> cf. <i>polyspernum</i>	plodić	KR	NK							0+1
cf. <i>Echinochloa crus-galli</i>	pšeno s pljev.	KR	NK							0+1
<i>Hordeum vulgare</i>	pšeno	K-Ž	K							87+0
cf. <i>Hordeum vulgare</i>	fragm. i def. pšeno	K-Ž	K	1						7+0
<i>Panicum miliaceum</i>	pšeno	K-Ž	K	2						283+0
cf. <i>Panicum miliaceum</i>	pšeno	K-Ž	K							57+0
<i>Panicum/Setaria</i> sp.	pšeno	K-Ž	K							20+0
<i>Poaceae</i>	pšeno		K							1+0
cf. <i>Poaceae</i> (cf. <i>Cerealia</i> )	fragm. stabljike		NK							0+6
<i>Polycnemum arvense/majus</i>	plodić	KR	NK							0+11
<i>Polygonum lapathifolium</i>	plodić	KR	NK							1+25
<i>Prunus domestica</i>	koštica s osušenim usplođem	K-V	K							1+0
<i>Rubus fruticosus</i> agg.	koštica	SK	K							2+0
<i>Secale cereale</i>	pšeno	K-Ž	K							2+0
<i>Setaria</i> cf. <i>italica</i>	pšeno	K-Ž	K						0+1	4+0
<i>Setaria</i> sp.	pšeno		K						0+2	1+0
cf. <i>Spergularia arvensis</i>	sjemenka		K							1+0
<i>Triticum aestivum</i> gr.	pšeno	K-Ž	K							4+0
<i>Triticum spelta</i>	pšeno	K-Ž	K							1+0
<i>Vicia faba</i>	sjemenka	K-M	K							6+0
indet.			K+NK		2+0					34+11
ukupno:			K+NK	14+1	2+0	13+0	0+19	0+5		654+152

Tablica 8 – IV. dio. Virovitica Kiškorija jug – popis biljnih nalaza iz rimskog razdoblja



TAXA:	PLANT REMAINS:	ECOLOGICAL GROUPS:	C/NC:	SU 1012, S 222 ?	SU 1355, 2 <sup>nd</sup> -3 <sup>rd</sup> century?	SU 1363, early 5 <sup>th</sup> century	SU 1936, S 264 ?	SU 1978, 2 <sup>nd</sup> century ?	SU 2155, S 261 ?	in total: K+NK:
<i>Agrostemma githago</i>	seed	WR	C							1+0
<i>Cerealia</i>	grain	Cu-Ce	C	11						123+0
cf. <i>Cerealia</i>	grain segment	Cu-Ce	C		13					18+0
<i>Chenopodium album</i>	fruit	WR	NC	1			19	5	1	0+93
<i>Chenopodium</i> sp.	fruit segment		NC							0+4
<i>Chenopodium</i> cf. <i>polyspernum</i>	fruit	WR	NC							0+1
cf. <i>Echinochloa crus-galli</i>	grain with chuff	WR	NC							0+1
<i>Hordeum vulgare</i>	grain	Cu-Ce	C							87+0
cf. <i>Hordeum vulgare</i>	deformed grain segment	Cu-Ce	C	1						7+0
<i>Panicum miliaceum</i>	grain	Cu-Ce	C	2						283+0
cf. <i>Panicum miliaceum</i>	grain	Cu-Ce	C							57+0
<i>Panicum/Setaria</i> sp.	grain	Cu-Ce	C							20+0
<i>Poaceae</i>	grain	Cu-Ce	C							1+0
cf. <i>Poaceae</i> (cf. <i>Cerealia</i> )	stem segment		NC							0+6
<i>Polycnemum arvense/majus</i>	fruit	WR	NC							0+11
<i>Polygonum lapathifolium</i>	fruit	WR	NC							1+25
<i>Prunus domestica</i>	fruit stone with dried pericarp	Cu-F	C							1+0
<i>Rubus fruticosus</i> agg.	fruit stone	W	C							2+0
<i>Secale cereale</i>	grain	Cu-Ce	C							2+0
<i>Setaria</i> cf. <i>italica</i>	grain	Cu-Ce	C						0+1	4+0
<i>Setaria</i> sp.	grain	Cu-Ce	C						0+2	1+0
cf. <i>Spergula arvensis</i>	seed		C							1+0
<i>Triticum aestivum</i> gr.	grain	Cu-Ce	C							4+0
<i>Triticum spelta</i>	grain	Cu-Ce	C							1+0
<i>Vicia faba</i>	seed	Cu-P	C							6+0
indet.			C+NC		2+0					34+11
in total:			C+NC	14+1	2+0	13+0	0+19	0+5		654+152

Table 8 – part IV Virovitica Kiškorijski south – a list of plant finds from the Antiquity



SVOJITE:	BILJNI OSTACI:	EKOL. GRUPE:	K/NK:	8-9. st.	SJ 620, U 190	SJ 620, U 191	SJ 622, U 193	SJ 1061, U 247	SJ 1172, U 230	SJ 1211, U 217	8. st.?	SJ 1241, U 250	SJ 2028, U 240	SJ 2030, U 251	SJ 2151, U 281	ukupno, K+NK:
<i>Cerastium</i> sp.	sjemenka		K+NK		0+1		1+0									1+1
<i>Cerealia</i>	pšeno	K-Ž	K					70						5		75+0
cf. <i>Cerealia</i>	fragm. pšena	K-Ž	K			2										2+0
<i>Chenopodium album</i>	plodić	KR	NK		1					5		5	2			0+8
<i>Chenopodium</i> sp.	fragm. plodića		NK							1						0+1
cf. <i>Panicum miliaceum</i>	pšeno	K-Ž	K											3		3+0
Poaceae	pšeno		K				1									1+0
<i>Polycnemum arvense/majus</i>	plodić	KR	NK	1												0+1
<i>Polygonum lapathifolium</i>	plodić	KR	K+NK		0+2		0+1						0+1			0+4
<i>Rumex</i> sp.	plodić		K						1							1+0
<i>Sambucus ebulus</i>	sjemenka	KR	NK												2	0+2
<i>Secale cereale</i>	pšeno	K-Ž	K					1								1+0
<i>Setaria</i> cf. <i>pumila</i>	pšeno	KR	NK						1							0+1
<i>Setaria</i> sp.	pšeno		K				1									1+0
<i>Triticum aestivum</i> gr.	pšeno	K-Ž	K		3			13		1		1		3		20+0
cf. <i>Triticum aestivum</i>	pšeno	K-Ž	K						1							1+0
<i>Triticum spelta</i>	pšeno	K-Ž	K					2								2+0
<i>Triticum</i> sp.	fragm. pšena	K-Ž	K		2											2+0
cf. <i>Vitis vinifera</i>	def. sjemenka	K-V	K					1								1+0
indet.			K+NK		1+0			6+0	5+0				1+0	5+0		18+0
ukupno:			K+NK	0+1	6+4	2+0	3+1	93+0	7+1	0+1	1+5	1+3	16+0	16+0	0+2	129+18

Tablica 9 Virovitica Kiškoriya jug – popis biljnih nalaza iz razdoblja srednjeg vijeka



TAXA	PLANT REMAINS	ECOLOGICAL GROUPS	C/NC:	8 <sup>th</sup> -9 <sup>th</sup> Century	SU 620, S 190	SU 620, S 191	SU 622, S 193	SU 1061, S 247	SU 1177, S 230	8 <sup>th</sup> Century?	SU 1241, S 250	SU 2028, S 240	SU 2030, S 251	SU 2151, S 281	in total, K+NK:
<i>Cerastium</i> sp.	seed		C+NC	0+1			1+0								1+1
<i>Cerealia</i>	grain	Cu-Ce	C					70					5		75+0
cf. <i>Cerealia</i>	grain segment	Cu-Ce	C			2									2+0
<i>Chenopodium album</i>	fruit	WR	NC		1						5	2			0+8
<i>Chenopodium</i> sp.	fruit segment		NC							1					0+1
cf. <i>Panicum miliaceum</i>	grain	Cu-Ce	C										3		3+0
<i>Poaceae</i>	grain		C				1								1+0
<i>Polycnemum arvense/majus</i>	fruit	WR	NC	1											0+1
<i>Polygonum lapathifolium</i>	fruit	WR	C+NC		0+2		0+1					0+1			0+4
<i>Rumex</i> sp.	fruit		C						1						1+0
<i>Sambucus ebulus</i>	seed	WR	NC											2	0+2
<i>Secale cereale</i>	grain	Cu-Ce	C					1							1+0
<i>Setaria</i> cf. <i>pumila</i>	grain	WR	NC						1						0+1
<i>Setaria</i> sp.	grain		C				1								1+0
<i>Triticum aestivum</i> gr.	grain	Cu-Ce	C		3			13			1		3		20+0
cf. <i>Triticum aestivum</i>	grain	Cu-Ce	C						1						1+0
<i>Triticum spelta</i>	grain	Cu-Ce	C					2							2+0
<i>Triticum</i> sp.	grain segment	Cu-Ce	C		2										2+0
cf. <i>Vitis vinifera</i>	deformed seed	Cu-F	C					1							1+0
indet.			C+NC		1+0			6+0	5+0			1+0	5+0		18+0
in total			C+NC	0+1	6+4	2+0	3+1	93+0	7+1	0+1	1+5	1+3	16+0	0+2	129+18

Table 9 Virovitica Kiškorijska south – a list of plant finds from the Middle Ages

## Interpretacija arheobotaničkih i arheozooloških nalaza iz rimskog konteksta prema povijesnim izvorima

### *Interpretation of archaeobotanical and archaeozoological findings from Roman context according to historical sources*

Ivana Ožanić Roguljić

Prilikom istraživanja prikupljeni su uzorci zemlje i kostiju koji su analizirani arheobotaničkim i arheozoološkim analizama. Njima se utvrdilo da su se na Virovitici Kiškorijski jug konzumirale žitarice (ječam, proso, klipasti muhar, raž, pir, pšenica), grahorice (bob) i voće (kupina, šljiva) te različite životinje.<sup>1</sup> Kako bi bolje razumjeli rezultate tih analiza posegnuli smo u dostupne antičke povijesne izvore ne bismo li iz njih pokušali interpretirati nalaze dobivene arheometrijskim metodama.

#### *Žitarice*

Pristupstvo žitarica na lokalitetu Virovitica Kiškorijski jug moglo se pretpostaviti i nalazima žrvnjeva koji su služili za mljevenje (vidi poglavlje 4.4), no arheobotaničke analize su nam pokazale i koje su se vrste sadile i koristile.<sup>2</sup>

Uloga žitarica u prehrani neizmjerljivo je važna, služila je kao hrana za ljude i za stoku. Većina žitarica koristila se za kuhanje raznih hranjivih kaša, pečenje kruha te fermentaciju piva. Prema tradiciji, jednostavne kaše od žitarica (*puls*) bile su osnovna hrana Rimljana (Alcock 2006: 32). U žitarice se prema mogućnostima dodavalo grahorice, sir, meso, povrće, med i razne začine te se na taj način pripremalo razne vrste gušćih ili rjeđih variva (*tisana*, *conchicla*). Od 2. st. pr. Kr. kruh zamjenjuje kašu te postaje glavna prehranbena namirnica. Razvoj u tehnici mljevenja žitarica te otkriće prvih oblika kvasca smatraju se glavnim razlozima u ovoj promjeni prehranbene navike (Cool 2006: 71, 74–75). Kruh je i sastavni dio vojničkog sljedovanja (*Vegetius* III.3). U rimsko doba peklo su se razne vrste kruha, a njihovi nazivi u mnogočemu su slični današnjima. Osnovne vrste kruha su bijeli kruh (*panis mundus*) i punozrni kruh (*autopyrus*), s kvascem ili bezkvasni. Kruh je dobivao ime po načinu pripreme, obliku i načinu pečenja (*panis depsiticus*), porijeklu brašna ili jela uz koje je konzumiran (Cool 2006: 75; Dalby 2003: 58–61). U kruh su se dodavali i drugi sastojci kao što su sir (*libum*), papar ili mast (*Plinius NH*, XXII, 138; *Athenaeus*

During the excavations soil and bone samples were collected and analyzed by archaeobotanical and archaeozoological methods. Analyses showed that inhabitants of Virovitica Kiškorijski south consumed grains (barley, millet, foxtail millet, rye, spelt, wheat), legumes (broad bean), fruits (blackberry, plum) and various animals.<sup>1</sup> For better understanding of the results of these analyses we reached to the available ancient historical sources to interpret the findings gained using the archaeometrical methods.

#### *Cereals*

The presence of grains on Virovitica Kiškorijski south site was presumed since whetstones used for grinding were found (see chapter 4.4), however, archaeobotanical analysis have revealed the types of cereals that were used.<sup>2</sup>

Role of grains in the diet is extremely important; they were used as food for humans as well as for livestock. Most of the grains were used for cooking of a variety of nutritious porridges, baking of bread and fermenting beer. According to the tradition, a simple porridge (*puls*) was the basic food of the Romans (Alcock 2006: 32). Pulses, cheese, meat, vegetables, honey and various spices were added to the grains and various kinds of stews or gruels were prepared (*tisana*, *conchicla*). From the 2<sup>nd</sup> century BC onwards bread replaces porridge and becomes a major foodstuff. The development of the technique of grain grinding and the discovery of the first forms of yeast are considered the main reasons for this change in eating habits (Cool 2006: 71, 74–75). Bread is also an integral part of military rations (*Vegetius* III.3). In Roman times various types of bread were baked, and their names are similar as today. Basic types of bread are white bread (*panis mundus*) and full grain bread (*autopyrus*), with or without yeast. Bread was named according to the way of preparation, form and the method of baking (*panis depsiticus*), the origin of flour or the meal with which it was consumed (Cool 2006: 75; Dalby 2003: 58–61). Other ingredients such as cheese (*libum*), pepper

1 Za detalje vidi poglavlja 5.1. i 5.2.

2 Vidi poglavlje 5.4.

1 For details see chapters 5.1. i 5.2.

2 See chapter 5.4.



D. 109. b–d; *Cato Agr.* 74–75, Cool 2006: 75; Dalby 2003: 58–61).

Prema Dionu Kasiju tradicionalna hrana Panonaca bila je ječam i proso koje jedu i piju (*Dio Cassius* 49.36, 2–4). Fermentacijom ječma i prosa moglo se napraviti pivo koje bi se uklopilo u navod Diona Kasija, a i većina ostalih žitarica utvrđenih prilikom analize mogla je poslužiti i za izradu piva (Ožanić Roguljić 2004b: 36). Slično o pivu govori i Sv. Jeronim (Sv. Jeronim, *Comm. 7 in Isaiam* c.19). Pivo nije bilo popularno kod Rimljana i pijeње piva smatralo se barbarškim ponašanjem i običajem siromašnih (Miličević Bradač 1999–2000: 69–70). Antički izvori pivo vežu uz Galiju, Hispaniju i Egipat (*Plinius NH*, XIV, 29). Car Valens koji je rodom iz Cibala imao je nadimak *sabaiarius* (pivopija ili pivska bačva) (*Ammianus Marcellinus* 26.8.2; Miličević Bradač 1999–2000: 69–70; Džino 2005: 65–66). Pivo se moglo dodavati u brašno kako bi se ubrzao proces dobivanja kvasca (*Plinius NH*, XVIII.68; Cool 2006: 76).

Na lokalitetu Virovitica Kiškorija jug pronađena pšenica pripada vrsti *Triticum aestivum* koja je korištena za kruh (Šoštarić et al. 2006: 432; Bugar, Mašić 2013: 51–52). Jednozrna i dvozrna pšenica smatra se osnovnom žitaricom od neolitika, a u rimsko doba postaje najvažnija žitarica. Trgovina pšenicom odigrala je jednu od najistaknutijih uloga u ekonomskoj strukturi rimskog doba, bilo da je bila djelom tributa, *annone* ili slobodne trgovine (Kessler, Temin 2007: 330). Razne vrste pšenica dobivaju svoje ime prema zemljama gdje su po prvi puta uzgojene (*Plinius NH*, XII, 25). Osim za pečenje kruha, pšenica se, kao i sve žitarice, koristila i pri fermentaciji piva i kuhanju raznih jela, posebice kaša. Nalazi s panonskog dijela hrvatske mogu se smatrati lokalno uzgojenom pšenicom i zapravo, njena je prisutnost u arheobotaničkim nalazima očekivana, no ne donosi nam dovoljno podataka bilo o uzgoju ili trgovini ovom žitaricom (Alcock 2006: 32; Šoštarić et al. 2006: 433).

Proso i klipasti muhar po svojim su karakteristikama imali jednaku namjenu u kulinarstvu (Šoštarić et al. 2006: 432, Bugar, Mašić 2013: 51–52). O konzumaciji prosa u Panoniji saznajemo i preko Diona Kasija koji navodi da se jede i pije (*Dio Cassius* 49.36, 2–4). Prema Pliniju nekoliko se vrsta kruha radilo s prosom, jeo se ukuhan u kašu, te se radilo pivo (*Plinius NH*, XXI, 10). Od njega se radio i svojevrstan kvasac tj. kiseli kruh koji se koristio kao baza za svakodnevno pečenje kruha. Brašno od prosa se namočilo u mošt, zatim bi se umijesio i ostavio da odstoji i fermentira. Smjesa napravljena na ovakav način ostala bi svježja kroz čitavu godinu (*Plinius NH*, XVIII, 102–04).

Ječam kao tipična hrana Panonaca pronađen je i na lokalitetu Virovitica Kiškorija jug (Šoštarić et al. 2006: 432, *Dio Cassius* 49.36, 2–4). Široko je korišten kao hrana, stočna hrana i baza za izradu piva. Plinije stariji govori da je ječam bio hrana za gladijatore koji se prema tome zovu *hordearii* tj. ječmeni ljudi (*Plinius, NH*, XVIII,14). Kuhao se u

or fat were added to the bread as well (*Plinius NH*, XXII, 138; *Athenaeus D.* 109 bd; *Cato Agr.* 74–75; Dalby 2003: 58–61).

According to *Dio Cassius* traditional foods of Pannonians were barley and millet which they used to eat as well as drink (*Dio Cassius* 49.36, 2–4). By fermentation of barley and millet beer could have been made which fits the statement of *Dio Cassius*. Other cereals found during the analysis could have also been used for making beer (Ožanić Roguljić 2004b: 36). Similar tale about beer is confirmed by St. Jerome (*St. Jerome, Comm. 7 in Isaiam* C.19). Beer was not popular with the Romans and beer drinking was considered barbaric and the custom of the poor (Miličević Bradač 1999–2000: 69–70). Ancient sources associated beer to Gaul, Hispania and Egypt (*Plinius NH*, XIV, 29). Emperor Valens, who is originally from *Cibalae*, had a nickname *sabaiarius* (beer drinker or beer barrel) (*Ammianus Marcellinus* 26.8.2; Miličević Bradač 1999–2000: 69–70; Džino 2005: 65–66). Beer could be added to flour to speed up the process of getting yeast (*Plinius NH*, XVIII 68; Cool 2006: 76).

Type of wheat found at the Virovitica Kiškorija south site is *Triticum aestivum* and it is a bread wheat (Šoštarić et al. 2006: 432; Bugar, Mašić 2013: 51–52). Einkorn wheat and emmer are considered to be basic grains since the Neolithic while during the Roman times they become the most important crops. Wheat trade has played one of the most prominent roles in the economic structure of the Roman era, whether it was a part of tribute, *annona* or free trade (Kessler, Temin 2007: 330). Various types of wheat got their name from the countries where they were first cultivated (*Plinius NH*, XII, 25). Except for baking bread, wheat, like all grains, was used in beer brewing and cooking a variety of dishes, especially porridge. Findings from the Pannonian part of Croatia can be considered to be locally produced wheat and in fact, its presence among the archaeobotanical findings is expected, but does not bring us enough information about how the grain was cultivated or about its presence on the market (Alcock, 2006: 32; Šoštarić et al. 2006: 433).

Millet and foxtail millet were equally used in cooking owing to their characteristics (Šoštarić et al., 2006: 432, Bugar, Mašić 2013: 51–52). About the consumption of millet in *Pannonia* we learned from *Dio Cassius*, who states that it was used for eating and drinking (*Dio Cassius* 49.36, 2–4). According to Pliny, millet was used for making several types of bread, it was eaten as porridge, and the beer was made of it (*Plinius NH*, X 21). A kind of yeast was also made of millet and it was used as a base for daily bread baking. Millet flour was soaked in must, then mixed, kneaded, and left to stand and to ferment. The dough made in this way would remain fresh throughout the year (*Plinius NH*, XVIII, 102–04).

Barley, as a typical food of Pannonians, was also found at the Virovitica Kiškorija south site (Šoštarić et al. 2006: 432, *Dio Cassius* 49.36, 2–4). It was widely used as food, fodder and base for making beer. Pliny the elder says that barley was food for gladiators who were, therefore, called *horde-*



raznim jelima kao što su razne vrste kaša (*puls*) ili rjeđim tj. jušnijim varivima (*tisana*, *conchicla*). Od ječma se pekao kruh i radila *pollenta* (Applebaum 1958: 66–84; Cool 2006: 69–79; Thurmond 2007: 17–18, 34, 57). *Pollenta* je vrsta ječmenog kolača koji jedu ljudi ili se daje za dohranu malim životinjama npr. gušćićima (Farmer 1918: 135). Na prostoru Italika pšenica zamjenjuje ječam i ječmeni kruh se smatra prikladnim za stočnu hranu (*Plinius NH*, XVII, 29). Ječam je bio i najčešća žitarica korištena za dobivanje piva (Nelson 2005: 50).

Prema Pliniju starijem raž je hrana za siromašne koju se konzumira jedino u slučaju ekstremne gladi. Da bi se raži popravio okus umiješa se pir i onda je, po Pliniju, još uvijek neugodna za okus (*Plinius NH*, XVIII.40). U arheološkim kontekstima Rajne, Dunava i na Britanskim otocima postoje dokazi da se koristio i u proizvodnji piva (Kooistra 1996: 127; Cool 2006: 74, 144; Thurmond 2007: 17). Je li se na Kiškoriji jug koristio u prehrani ili kao krmivo nije moguće utvrditi.

Pir je također prisutan na lokalitetu. Zrno pira ima vrlo tvrdu ljusku koja se prije upotrebe mora oljuštiti što se postiže tučenjem pri čemu se ljuska odvoji od zrna. Na taj način se može dobiti žitarica koja je odlična kao baza za kvasni kruh. Pir se mogao transportirati neoljušten te se završno tučenje i mljevenje moglo izvršiti nakon dolaska na odredište (Cool 2006: 69–70; Thurmond 2007: 18).

#### Grahorice

Apicije je cijelo poglavlje posvetio receptima za kuhanje grahorica (*Apicius*, V). Apicije u naputcima za pripremanje grahorica često naglašava *accipies caccabum mundum* ili *accipies caccabum novum* tj. da je potrebno ili čisti ili novi lonac za pripremu što svakako upućuje na činjenicu da grahorice mogu biti i vrlo osjetljive za kuhanje i brzo zagorjeti. Grahorice su pogodne za preradu i konzumaciju svježih, a većinu je moguće osušiti i tako skladištiti dulje vrijeme (Flint-Hamilton 1999: 392; Dalby 2003: 252). Mogle su poslužiti i kao krmivo, a isto tako je poznato da grahorice oplemenjuju zemlju (Flint-Hamilton 1999: 373)

Bob je jedina vrsta grahorice pronađene na lokalitetu Virovitica Kiškorija jug i izuzetno je važna namirnica u prehrani. Prema izvorima bob je, uz ječam i pir, najčešće konzumirana hrana u rimsko doba, kuha se sa vinskim octom ili se miješa s ječmom (*puls fabata*). Plinije, premda jako hvali bob i daje naputke kako ga pravilno uzgajati, govori da i bob može izazvati nesanicu te je kod Pitegorejaca zabranjen (*Plinius, NH*, XVIII.117–12, XVIII.137, XXII.140–141). Zabrana se tumači s medicinskim stanjem nasljednog poremećaja metabolizma eritrocita (manjak enzima glukoza-6 fosfat dehidrogenaze) koji je često prisutna hemolitička bolest na Mediteranu i može biti pojačan kod prekomjernog konzumiranja boba (Flint-Hamilton 1999: Alcock 2006: 35)

*arii* i.e. barley people (*Plinius*, NH, XVIII, 14). It was cooked in various dishes such as various kinds of porridge (*puls*) or gruel (*tisana*, *conchicla*). Barley was used for baking breads and *pollenta* (Applebaum 1958: 66–84; Cool 2006: 69–79; Thurmond, 2007: 17–18, 34, 57). *Pollenta* is a kind of barley cake eaten by people or given as complementary food for small animals, for example goslings (Farmer 1918: 135). In the area of Italy, wheat replaced barley and barley bread was considered suitable for animal feed (*Plinius NH*, XVII, 29). Barley was the most common grain used for beer production (Nelson 2005: 50).

According to Pliny the Elder rye was food for the poor, which was consumed only in case of extreme hunger. To improve the flavour of rye spelt was mixed in and then, according to Pliny, it was still not very tasteful (*Plinius NH*, XVIII, 40). In archaeological contexts of the Rhine, the Danube and the British Isles there are evidence that it was used in the production of beer (Kooistra 1996: 127; Cool 2006: 74, 144; Thurmond, 2007: 17). We cannot determine if at the Virovitica Kiškorija south site it was used in the diet or as fodder.

Spelt is also present at the site. Grain of spelt has a very hard shell which had to be peeled off before use, which was achieved by milling. In this way a cereal which is great as a base for yeast bread was acquired. Spelt could be transported unpeeled and the final milling and grinding could have been done after the arrival to the destination (Cool 2006: 69–70; Thurmond, 2007: 18).

#### Legumes

Apicius devoted a whole chapter to recipes for cooking legumes (*Apicius*, V). In the instructions for preparing legumes Apicius often emphasizes *accipies caccabum mundum* or *accipies caccabum novum*, meaning it is necessary to clean a pot or use a new pot to prepare them. This certainly suggests that legumes can be very sensitive to cooking and quickly burned. Legumes are suitable for processing and consumption when they are fresh, and most of them can be dried and stored for a long time as well (Flint - Hamilton 1999: 392; Dalby 2003: 252). They could also serve as fodder, and they are known to enrich the soil (Flint - Hamilton 1999: 373).

Broad bean is the only legume found at the Virovitica Kiškorija south site and is extremely important in the diet. According to sources, broad bean, along with barley and spelt, belongs to the most commonly consumed foods in Roman times. It is cooked with vinegar or mixed with barley (*pulse fabata*). Although Pliny praises broad bean and gives instructions on how to properly grow it, but he also says that broad beans can cause insomnia and that they have been banned by Pythagorians (*Plinius NH*, XVIII, 117–12, XVIII, 137, XX 140–141). The prohibition is explained by the medical condition of hereditary metabolic disorder of erythrocytes (deficiency of the enzyme glucose-6 phosphate dehydrogenase), which is an often present hemolytic disease in the Mediterranean and can be enhanced with the over consumption of broad beans (Flint-Hamilton 1999: Alcock, 2006: 35).

### Voće

Prema opisima i raznim slikovnim prikazima poznato je da su Rimljani uzgajali razne vrste voća i taj su običaj prenosili u provincije koje su ustrojili (Caneva, Kumanic 2009: 256). Arheološki nalazi s područja cijele Panonije i arheobotanički nalazi s mađarskih lokaliteta 3. i 4. st. pokazuju da se uz vile rustike počinju saditi napredno uređeni voćnjaci i vinograd (Bulat 2002: 46; Gyulai 2010: 157; Leleković, Rendić-Miočević 2012: 280)

Voće se jelo svježije ili sušeno, a mesnato voće (šljive, breskve) kiselo se ili konzerviralo na razne načine: u octu, medu, glini ili vinskim proizvodima ako što su *sapa*, *defrutum* ili *passum* (Plinius NH, XV, 62–65; Apicius 22, 1; Thurmond 2007: 184). Koristilo se u više vrste jela (*patina*, razni umaci za meso) i miješalo sa raznim sastojcima. Neke su vrste voća mogle biti i zaslađivač (npr. smokve). A poznato je da se voće cijenilo i u medicinskim i kozmetičkim pripravcima. Dioskurid i Plinije navode alkoholna pića koja su se radila od voća (Cool 2006: 129; Dalby 2003: 151)

Šljive (*Prunus spinosa*) su nađene na lokalitetu Virovitica Kiškorija jug. Rasle su divlje u Europi, no ostaci šljiva (*P. domestica*) s lokaliteta Virovitica Kiškorija jug su vrlo vjerojatno uzgojene u voćnjaku, no vrlo je teško reći je li taj voćnjak bio u Panoniji ili je riječ u uvozu (Wiethold 2000: 276; Alcock 2006: 46). Šljive su se jele svježije, sušene ili ukiseljene (Thurmond: 2007, 184). Apicije predlaže da se serviraju kao predjelo i mogu se miješati u razne umake. Dok govori o šljivi Apicije koristi termin *damascena* koji se ponekad smatra suhom šljivom, a ne posebnom vrstom šljive (Plinius NH, XV.41–44, Apicius, I, XX; IV, V, 147; VII, V, 274). Plinije kaže da šljive iskuhane u vinu mogu biti korisne kod upala usne šupljine i djelovati umirujuće za probavu (Plinius NH, XVIII, 102–04).

Kupina je u rimsko doba još uvijek divlja biljka (Zohary, Hopf 2000: 176). Sjemenke su nađene na mnogim rimskim lokalitetima (npr. latrina u Koelnu, *Germania*). Korištene su u medicinske svrhe (Galen 12.920, Anthimus OC 86), a Paladije (Paladije OA 10.16) spominje *diamoron*, sirup koji se radi tako da se umiješa jednaki omjer soka od kupine i meda (Dalby 2003: 54, 55).

### Životinjski ostaci

Generalno je prihvaćeno da se Rimsko Carstvo prema primarnom uzgoju stoke može podijeliti na tri dijela: Na sjeveru – goveda, sjeverni Mediteran s Italijom – svinje, Sjeverna Afrika i istok – ovce i koze (Arthur 2007: 25, sl. 10). No, ovakvu se shemu uvijek treba uzeti s određenom zadržkom, jer je postojala razlika u prehrani u gradu i selu ili na nekom užem području. Arheozoološki podaci s lokaliteta Virovitica Kiškorija jug malobrojni su i u jako lošem stanju za bilo kakav generalni zaključak, no vidljivo je da su utvrđene kosti sve te tri grupe životinja. Ostaci pokazuju govedo, svinju, ovcu ili kozu, konja ili magarca.

### Fruits

According to the descriptions and the various pictorial representations is known that the Romans cultivated various kinds of fruits and that that custom passed into the provinces which they have established (Caneva, Kumanic 2009: 256). Archaeological finds from all of *Pannonia* and archaeobotanical analyses from Hungarian sites from the 3<sup>rd</sup> to the 4<sup>th</sup> century indicate that at that time advanced orchards and vineyards were planted around *villae rusticae* (Bulat 2002: 46; Gyulai, 2010: 157; Leleković, Rendić-Miočević 2012: 280).

Fruit was eaten fresh or dried, while fleshy fruits (plums, peaches) were pickled or stored in various ways: in vinegar, honey, clay or wine products as are *sapa*, *defrutum* or *passum* (Plinius NH, XV, 62–65; Apicius 22, 1; Thurmond, 2007: 184). Fruits were used in several types of food (*patina*, various sauces for meat) and mixed with various ingredients. Some types of fruit may have been used as sweetener (e.g. figs). It is also known that fruits had medical and cosmetic value. Dioscurides and Pliny referred to alcoholic beverages made of fruit (Cool 2006: 129; Dalby 2003: 151)

At the Virovitica Kiškorija south site plums (*Prunus spinosa*) were found. They grew wild in Europe, but remains of plums (*P. domestica*) from the Virovitica Kiškorija south site were most likely grown in the orchard. Nevertheless, it is very difficult to say whether this orchard was in *Pannonia*, or if they came as an import (Wiethold 2000: 276; Alcock, 2006: 46). Plums were eaten fresh, dried or pickled (Thurmond: 2007, 184). Apicius proposes to serve them as an appetizer and they can be mixed in a variety of sauces. While talking about the plum Apicius uses the term *damascena* which is sometimes considered to be a dry plum, and not a special kind of plums (Plinius NH, XV, 41–44, Apicius, I, XX, IV, V, 147; VII, V, 274). Pliny says that plums boiled in wine can be useful in treatment of mouth inflammation and act soothing for the digestion (Plinius NH, XVIII, 102–04).

Blackberry is still a wild plant during the Roman times (Zohary, Hopf 2000: 176). Its seeds can be found at numerous Roman sites (eg. *latrina* in Cologne, *Germania*). They were used for medicinal purposes (Galen 12. 920, Anthimus OC 86) and Palladium (*Palladium* OA 10.16) mentions *diamoron* syrup made of same ratio of blackberry juice and honey (Dalby 2003: 54, 55).

### Animal remains

It is generally accepted that the Roman Empire, can be divided into three parts according to the primary bred cattle: the north – cattle, northern Mediterranean to Italy – pigs, North Africa and the East – sheep and goats (Arthur, 2007: 25, fig. 10). However, such a scheme should always be taken with some caution because there was a difference between the diet in the countryside and in the urban settlements. Archaeozoological data from the Virovitica Kiškorija south site is scarce and in very poor condition for any general conclusions to be made, but it is evident that the analysed bones belong to all those groups of animals. The remains represent cattle, pig, sheep or goat, horse or



Prema nekim arheološkim svjedočanstvima smatra se da su krave klale tek nakon što su prestale davati mlijeko i zapravo se prvenstveno uzgajaju zbog mlijeka i mliječnih proizvoda, a manje zbog mesa te da se isto tako postupalo i s ovcama i kozama, dok na nekim drugim lokalitetima vidimo da je jedna trećina konzumiranih namirnica bilo meso. Također, mora se istaknuti da se jelo i druge vrste mesa (perad, divljač) te riba. Od peradi se često konzumirala piletina, kokoši i golubi. Guske, fazani te druge egzotične životinje smatraju se jelom za bogatije (Killgrove 2010: 150). Jaja su bilo često zastupljena u prehrani i bili su sastavni dio jela koji se zove *patina* i koje je dalo ime jednom obliku tanjura. Nalazi peradi ili jaja nisu prisutni no kako je utvrđeno analizama izrazita kiselost zemlje<sup>3</sup> (Šošćarić et al. 2014) moguće da je pogodovala nestanku kostiju, a pogotovo krhkih ljuski jajeta.

Plinije, Kolumela i Varon donose mnoge zapise o stočarstvu u rimsko doba (*Plinius NH, VIII, Columella 1.3.12; 6. 37. 10–11; Varro RR, 2.1.11–24*). Goveda, ovce i koze bile su uzgajane zbog mesa, mlijeka i mliječnih prerađevina, dok su se konji i magarci jeli samo u nuždi. Dapače, koristiti konja za jelo bio je svojevrsni taboo (Alcock 2006: 64–67). U svim starim civilizacijama goveda su se jela rijetko jer su korištena kao radne životinje, a mlijeko i mliječni proizvodi imali su izuzetno važnu ulogu u prehrani (Cool 2006: 85). Krave su se klale kad su bile prestare i više nisu mogle davati mlijeko ili donositi telad (Humphrey et al 1999: 127; Alcock 2006: 66). Ovce i koze su se uzgajale zbog mesa i mlijeka od koje se dobiva odličan sir. Njihovo je mlijeko bilo cjenjenije nego kravlje (*Varro RR 2. 10.11, Humphrey et al. 1999: 127*). Ovce se držalo i zbog vune, a od koza se dobivala odlična koža za štavljenje (Alcock 2006: 67).

Uzorci s lokaliteta Virovitica Kiškorija jug nisu mogli dati podatak o starosti životinje. Rimljani su svinju smatrali najkorisnijom životinjom i prema Varonu nije bilo rimske farme bez svinje. Sve se moglo iskoristiti od svinje od mesa, iznutrica, kože, repa i papka, a jela su gotovo sve (*Varro, RR, 2.4.3*). Apicije u *De re coquinaria* pokazuje oko pedeset načina kako pripremiti svinjetinu (*suila, porcina*) (*Apicius 1, 8–6, Cato Agr. 162 1–3*). Svinjetina je bila kuhana ili pečena, prelivena medom i raznim umacima i pretvarana u kobasice i miješana čak s ribom ili drugim mesom i sastojcima u jelo koje se zvalo *patina*. Bila je dio (*lardum*) vojničkih sljedovanja (*Vegetius IV, 7*). Mast (*laridum*) se koristila za kuhanje, kao gorivo za osvjetljavanje prostora umjesto maslinovog ulja (Alcock 2006: 67).

O mlijeku i mliječnim prerađevinama imamo malo podataka. Mlijeko se pilo, ali se više koristilo za preradu u kiselo mlijeko, sir pa čak i maslac. Dokument o proizvodnji sira nalazimo keramičkom predmetu – kalupu za sir kakav se pronalazi na većini rimskih lokaliteta 1 i 2. st. (Ožanić

donkey.

According to some archaeological testimonies it is considered that cows were slaughtered after they had stopped giving milk and that they were actually primarily bred for milk and dairy products, and less for meat which also applied to sheep and goats, while in some other places, we see that one third of the consumed food is meat. Also, it must be pointed out that food and other types of meat (poultry, game), and fish were eaten. Poultry is often consumed (chicken, hens and pigeons). Geese, pheasants and other exotic animals are considered to be food for richer people (Killgrove 2010: 150). Eggs have been often represented in the diet and were an integral part of the dish called *patina* which gave its name to one form of plates. Poultry or eggs are not present among the findings which can be explained by the analysis of soil that determined an extreme acidity<sup>3</sup> (Šošćarić et al. 2014) which can be the reason of the disappearance of bones, and especially of fragile eggshells.

Pliny, Columella and Varro left numerous records of animal husbandry in the Roman period (*Plinius NH, 8, Columella DRR, 1.3.12, 10–11; Varro RR, 2.1.11–24*). Cattle, sheep and goats were kept for meat, milk and dairy products, while horses and donkeys were eaten only in an emergency. The use of horses for food was a kind of a taboo (Alcock, 2006: 64–67). In all ancient civilizations cattle was rarely eaten because it was used for work, while milk and dairy products had a very important role in the diet (Cool 2006: 85). Cows were slaughtered when they were too old and could no longer give milk or calve (Humphrey et al. 1999: 127; Alcock, 2006: 66). Sheep and goats were bred for meat and milk, of which excellent cheese was produced. Their milk has been more valued than cow's milk (*Varro RR, 10.11, Humphrey et al., 1999: 127*). Sheep were kept for wool, while goats gave excellent leather (Alcock 2006: 67).

Samples from the Virovitica Kiškorija south site could not provide information on the age of the animals. The Romans considered that the most useful of all animals is a pig and according to Varro there was not a Roman farm without them. Everything from a pig could have been used: meat, entrails, skin, tail and hoofs, and pigs ate almost everything (*Varro RR, 2.4.3*). Apicius in *De re coquinaria* offers about fifty ways for preparing pork (*suila, porcina*) (*Apicius 1, 8–6, Cato Agr. 162 1–3*). Pork was served cooked or roasted, topped with honey and various sauces and turned into sausages and even blended with fish or some other meat and ingredients in a dish that is called *patina*. It was a part of military rations (*Vegetius IV, 7*). Fat (*laridum*) was used for cooking, and as a fuel for illumination of rooms instead of olive oil (Alcock, 2006: 67).

We have scarce information about milk and dairy products. Milk was drunk, but it was more often used for the processing of sour milk, cheese and even butter. The proof of the cheese production are ceramic moulds for cheese making which can be found on most Roman sites from the

3 Analize kiselosti su pokazalo kako je tlo kiselo, a kiselost je naglašenija na jugu.

3 Acidity analysis showed that the soil is acidic and that the acidity is higher in the south.

Roguljić 2010: 174).

Izvori daju izvrsne naputke kako napraviti i začiniti tri različita proizvoda od kiselog mlijeka (*oxygala*, *melca*, i *schiston*) (*Columella*, DRR 12.8.1–3; *Apicius* XI, 9; *Plinius* NH, XXVIII, 15–16, 134–135). Maslac (*butyrum*) se pretežno koristio kao kozmetički ili medicinski proizvod, a izrađivao se u drvenim posudama. Plinije ga smatra omiljenim barbar-skim jelom i predlaže da se pomiješan s medom služi kao pomast pri rastu i njezi zuba (*Plinius* NH, XXVIII, 15, 133).

#### Upotreba posuđa

Ponešto škrti podaci iz arheoloških i zooloških analiza zapravo slijede i analizu uporabe posuđa. Lonci su prvenstveno namijenjeni izlaganju većoj toplini i zadržavanju tekućine prilikom kuhanja ili varenja. Mogu dulje vrijeme stajati na ognjištu te se tako lakše omekša meso (npr. svinjetina ili govedina) i povrće (Arthur 2007: 18–19). Osam tipova lonaca<sup>4</sup> utvrđenih na lokalitetu te njihova statistička učestalost govore o velikoj potrebi za posuđem koja je mogla podnositi dulje kuhanje na vatri. Jela koja su pripremana u njima najvjerojatnije su bila više jušna jela nalik na varivo.

Duboke zdjele smatraju se pogodne za kuhanje žitarica i grahorica te mesa kao što je kozletina, ovčatina ili janjetina. Kuhanjem u tako otvorenoj posudi postiže se veće isparavanje tekućine te se na taj način dobiva suho ili gusto jelo prikladno za upotpunjavanje nekim umakom (Arthur 2007: 18). Dva tipa zdjela<sup>5</sup> mogle su biti pogodne za pripremanje upravo takvih namirnica koje su potvrđene i arheozoološkim i arheobotaničkim analizama. Prema njihovoj strukturi vidimo također da su mogle podnositi stajanje na vatri koje je potrebno za dulje iskuhavanje, pogotovo grahorica kojima je potrebno dulje vrijeme kuhanja. Jela koja su se mogla pripremati bila su guste ili rjeđe kaše.

Tanjuri nađeni na lokalitetu mogli su imati dvojaku ulogu bilo da su poslužili kao kalup za kruh ili za pripremanje jela koje se zove *patina*, nalik na složenac ili nabujak u kojima se miješaju meso, riba, jaja, grahorice, povrće, pa čak i orašasti plodovi.

Pojava taronika može biti jedan od pokazatelja prihvaćanja rimskih običaja u osvojenim područjima. Na Virovitici Kiškoriji jug ustanovljena su tri tipa<sup>6</sup> taronika koji se datiraju u razdoblje kasne antike. Predstavljaju odlično svjedočanstvo o nekoj fazi pripreme hrane te donose podatak da je stanovništvo u kasnoj antici prihvatilo jedan dio rimskog načina života unutar svojih tradicionalnih vrijednosti.

1<sup>st</sup> to the 2<sup>nd</sup> century (Ožanić Roguljić 2010: 174).

Sources provide excellent instructions on how to make and season three different products made of sour milk (*oxygala*, *melca* and *schiston*) (*Columella* DRR, 12.8.1–3; *Apicius* XI, 9; *Plinius* NH, XXVIII, 15–16, 134–135). Butter (*butyrum*) was mainly used as a cosmetic or medical product, and was made in wooden vessels. Pliny considers it a favourite barbarian meal and suggests that mixed with honey it can be used as an ointment during the growth and care of the teeth (*Plinius* NH, XXVIII, 15, 133).

#### Function of dishes

Somewhat scarce data from the archaeological and zoological analysis actually accompanies the analysis of the use of the dishes from the site. Pots were primarily designed to sustain exposure to heat and to retention fluids during the cooking or brewing. They can endure long time on the hearth, and thus it is easier to soften meat (e.g. pork or beef) and vegetables (Arthur, 2007: 18–19). Eight types of pots<sup>4</sup> from the site and the statistics of their frequency give the information about the great need for dishes which could endure longer cooking over the fire. Meals prepared in them were probably more often soup dishes such as stew.

Deep bowls are considered to be suitable for cooking of grains and pulses, and meats such as goat meat, mutton or lamb. Cooking in such open vessels greater evaporation of fluid is achieved which results in dry or thick dishes which could be supplemented by various sauces (Arthur 2007: 18). Two types of bowls<sup>5</sup> could be suitable for the preparation of such foods confirmed by archaeozoological and archaeobotanical analysis. According to their fabric, we also see that they were able to bear standing over the fire, which is necessary for long boiling, especially of the pulses that require longer cooking time. Dishes which could have been prepared in such manner are porridge and gruel.

Plates that were found at the site might have had a dual use, that is, they could have served as a bread mould or for preparing a meal called *patina*, similar to a casserole or a soufflé in which meat, fish, eggs, pulses, vegetables and even nuts are combined.

The appearance of mortars may be an indication of acceptance of Roman customs on the conquered territories. On Virovitica Kiškorija south we found three types of mortars<sup>6</sup>, which are dated to the period of Late Antiquity. They represent an excellent testimony of stages of food preparation, and bring information that the population in Late Antiquity accepted part of the Roman way of life within their traditional values.

4 sl. 132–140 u poglavlju 4.2.2.

5 sl. 142–145 u poglavlju 4.2.3.

6 sl. 154 u poglavlju 4.2.6.

4 Fig. 132–140 in chapter 4.2.2.

5 Fig. 142–145 in chapter 4.2.3.

6 Fig. 154 in chapter 4.2.6.



Biljke / životinje Plants / animals	Proizvodi / products
Ječam / Barley (lat. <i>Hordeum vulgare</i> )	Kruh / Bread Pivo / Beer Razna gusta jela: kaša, <i>pollenta</i> / Various dishes: porridge, gruel, <i>pollenta</i> , Krmivo / Fodder
Proso / Broomcorn millet (lat. <i>Panicum miliaceum</i> )	Kruh / Bread Pivo / Beer Razna gusta jela: kaša, <i>pollenta</i> / Various dishes: porridge, gruel, <i>pollenta</i> ,
Klipasti muhar / Foxtail millet (lat. <i>Setaria italica</i> )	Kruh / Bread Pivo / Beer Razna gusta jela: kaša, <i>polenta</i> / Various dishes: porridge, gruel, <i>pollenta</i> ,
Riža / Rye (lat. <i>Secale cereale</i> )	Kruh / Bread Pivo / Beer Razna gusta jela: kaša, <i>pollenta</i> / Various dishes: porridge, gruel, <i>pollenta</i> ,
Pir / Spelt (lat. <i>Triticum spelta</i> )	Kruh / Bread Pivo / Beer
Pšenica / Wheat (lat. <i>Triticum aestivum</i> )	Kruh / Bread Pivo / Beer Razna gusta jela: kaša, <i>pollenta</i> Various dishes: porridge, gruel, <i>pollenta</i> , Krmivo / fodder
Bob / Broad bean (lat. <i>Vicia faba</i> )	Razna gusta jela: kaša / Various dishes: porridge, gruel
Kupina / Blackberry (lat. <i>Rubus fruticosus</i> )	Konzumira se svježe i osušeno, konzervira u medu / Eaten fresh and dried, preserved in honey Medicinska upotreba / Medicinal use Sirup s medom / Syrup with honey
Šljiva / Plum (lat. <i>Prunus domestica</i> )	Konzumira se svježe i osušeno, konzervira u medu, ukuhava se s vinom / Eaten fresh and dried preserved in honey, boiled with wine razna jela: Umaci / Various dishes: sauces Medicinska upotreba / Medical purpose
Govedo / Cattle (lat. <i>Bos Taurus</i> )	Radne životinje / Mostly draught animal Meso / Meat Mlijeko / Milk Koža / Leather
Svinja / Pig (lat. <i>Sus sp.</i> )	Meso / Meat Koža / Leather
Ovca/koza / Sheep/Goat (lat. <i>Ovis/Capra</i> )	Meso / Meat Mlijeko / Milk Koža / Leather
Konj / magarac / mula / Horse / Donkey / Mule (lat. <i>Equus/Asinus</i> )	Radna životinje / Traveling, Draught animal

Tablica 10 Namirnice pronađene u antičkim cjelinama i mogućnost njihove upotrebe

Table 10 Foodstuffs found in antique units and possibilities of their usage

## Zaključak

Usporedbom analize arheoloških, arheobotaničkih i arheozooloških nalaza iz rimskog naselja s antičkim pisanim izvorima i objavljenim podacima iz suvremenih mjesta u ovoj regiji dobivamo uvid u prehrabene navike nekadašnjih stanovnika, kao i na svakodnevni život u ovom selu. Arheobotaničke i arheozoološke analize udružene s kvalitetno razrađenom tipologijom posuđa predstavljaju pravu smočnicu rimskog razdoblja na lokalitetu Virovitica Kiškorija jug (Tab. 10). Prema tim analizama znamo sa sigurnošću da se skladištilo i pripremalo žitarice, grahorice, voće te mesne, ali i mliječne prerađevine.

Prehrabene navike tijekom rimskog razdoblja bile su raznolike i u carskim provincijama bile su pod utjecajem namirnica koje su dostupne lokalno ili putem trgovine. Analiza materijala iz Virovitice Kiškorija Jug potvrdila je izjavu Diona Kasija da se ječam i proso tradicionalno konzumiraju u Panoniji. Žitarice i mahunarke utvrđene na lokalitetu mogle su se pripremati kao kaša, varivo, kruh ili pivo, a sve se te namirnice, jela i piće smatraju tipičnim za panonske prehrabene navike. Većina nalaza može se protumačiti kao lokalni uzgoj.

Identificirane životinjske vrste pronađene su u nedovoljnom broju da bi mogli izvući neke precizne zaključke. Životinje su se mogle držati zbog mlijeka, mesa, kože, vune ili su se koristile kao radne životinje.

Posuđe pronađeno na lokalitetu pretežno pripada kuhinjskom posuđu i prati potrebe pripremanja svih namirnica pronađenih na lokalitetu.

Slika dobivena o prehrani na lokalitetu Virovitica Kiškorija Jug može se smatrati odjekom tipičnih prehrabnenih navika rimske provincije Panonije.

## Conclusion

Comparing archaeological, archaeobotanical and archaeozoological analysis from the Roman settlement with ancient written sources and published data from contemporary sites in this region gives an insight into the eating habits of residents, as well as into the everyday life in this village. Archaeobotanical and archaeozoological analysis associated with elaborated typology of dishes represent a real pantry of Roman period at the Virovitica Kiškorija south site (Tab. 10). According to these analyses we know with certainty that grains, pulses, fruits, meat as well as the dairy products were prepared and stored.

Dietary habits during the Roman period in the imperial provinces were diverse and they were affected by the foods which were available locally or through trade. Analysis of the material from Virovitica Kiškorija south site confirmed the statement of *Dio Cassius* that barley and millet were traditionally consumed in Pannonia. Cereals and pulses identified at the site could have been prepared as porridge, gruel, bread and beer, and all of these foods, meals and drinks are considered typical for the Pannonian eating habits. Most of the findings can be interpreted as locally grown or bred.

The identified species were not found in sufficient numbers to enable any precise conclusions. The animals could have been kept for their milk, meat, leather, wool, or they could have been used as draught animals.

Dishes found at the site are predominantly kitchenware and meet the need for preparing all the ingredients found on the site.

The obtained picture of the nutrition at the Virovitica Kiškorija south site can be considered as an echo of typical dietary habits in the Roman province of Pannonia.

6.

*Virovitica Kiškorija Jug u ranom srednjem vijeku*

*Virovitica Kiškorija South during the early Middle ages*







## Virovitica Kiškoriya Jug u ranom srednjem vijeku Virovitica Kiškoriya South during the early Middle ages

Tajana Sekelj Ivančan  
Tatjana Tkalčec

Blago povišena greda na položaju Virovitica Kiškoriya jug, nedaleko Virovitice, naseljena u antici u razdoblju od 2. do sredine 5. stoljeća privukla je svojim prirodnim pogodnostima i ranosrednjovjekovno stanovništvo ovog kraja. Trasom ceste obuhvaćen je, čini se, tek dio srednjovjekovnog naselja, s ostacima tek dvadeset i sedam objekata - kuća, peći i jama. Središte srednjovjekovne naselju, kako je zaključeno prema brojnosti srednjovjekovnih površinskih nalaza, valjalo bi tražiti na zapadnom, istaknutijem položaju pješčane grede.

Nakon provedenih zaštitnih arheoloških iskopavanja 2005. godine (Jelinčić 2006a; 2006b; 2007a), pristupilo se obradi i mlađeg sloja nalazišta te su objavljene otkrivene ranosrednjovjekovne arheološke cjeline i keramička građa<sup>1</sup> (Sekelj Ivančan, Tkalčec 2008). Na temelju prikupljene pokretne arheološke građe, ustavovljeno je da se srednjovjekovni nepokretni nalazi rasprostiru na istraženoj površini trase ceste na dužini od 300 metara (sl. 211). Na sjevernom dijelu nalazišta istražena je skupina od četiri objekata (SJ 20, 30, 119, 369), a stotinjak metara južnije istražena je skupina od sljedećih četiri objekta (SJ 523, 621, 623, 629). Najveća koncentracija srednjovjekovnih arheoloških cjelina započinja je 30 m južnije od potonje. Sastojala se od dva stambena objekta (kuće SJ 1242 i SJ 1358), dvije peći (SJ 1062/2030 i SJ 2152+2305), stupova (SJ 1092, 1274, 1314, 1326) te objekata nepoznate namjene, možda ostataka kuća, radnih ili drugih gospodarskih objekata seoskih domaćinstava (SJ 1178, 1212, 1236), dok se na južnom dijelu istražene trase ceste nalazila skupina objekata nedefinirane namjene (SJ 1721, 2050, 1817) i ostaci stupova (SJ 1813, 2042, 2056, 1959, 2132) (sl. 212).

Na temelju detaljne analize keramičkog materijala, potkrijepljene apsolutnim datacijama, istražene cjeline vremenski su opredijeljene u dva osnovna horizonta: I – stariji iz kraja 8. i 9. stoljeća te mlađi koji se dijeli na horizont IIa – kraj 9. i početak 10. stoljeća i na horizont IIb – druga trećina 10. stoljeća (sl. 213).

Starijem horizontu pripadaju objekti na sjeveru lokaliteta (SJ 20, 30, 119) te u središnjem dijelu južne

Slightly elevated hillock on the position Virovitica Kiškoriya south, near Virovitica, inhabited in ancient times from the 2<sup>nd</sup> to the mid-5<sup>th</sup> century, with its natural assets, attracted the early medieval inhabitants of the region. It would seem that the route of the road covers only a part of the medieval settlement, with the remains of only twenty-seven facilities - houses, oven and pits. The centre of the medieval village, as one might conclude based on the number of medieval surface findings, should be looked for in the more prominent western portion of the sandy hillock.

After the rescue archaeological excavations in 2005 (Jelinčić 2006a; 2006b; 2007a), interpretation of the younger layer of the site was carried out and early medieval archaeological units and ceramic materials were published<sup>1</sup> (Sekelj Ivančan, Tkalčec 2008). Based on the movable archaeological material thus collected, it was established that the medieval immobile finds are spreading along the explored section of the route of the road at the length of 300 meters (fig. 211). In the northern part of the site a group of four features was explored (SU 20, 30, 119, 369) while a few hundred meters to the south, another group of four features, (SU 523, 621, 623, 629), was investigated. The highest concentration of medieval archaeological units begins 30 m to the south from the latter. It consisted of two residential buildings (houses SU 1242 and SU 1358), two ovens (SU 1062/2030 and SU 2152 + 2305), posts (SU 1092, 1274, 1314, 1326) and of features of unknown purpose, possibly the remains of houses, working and economic areas or other outbuildings of rural households (SU 1178, 1212, 1236), while in the southern part of the investigated section of the road a group of buildings of undefined purpose (SU 1721, 2050, 1817) and remains of the posts (SU 1813, 2042, 2056, 1959, 2132) were located (fig. 212).

Based on a detailed analysis of the ceramic material, supported by an absolute dating, the explored units may be divided into two main horizons: I – the older one, from the end of the 8<sup>th</sup> to the late 9<sup>th</sup> century and the younger

1 Zahvaljujemo voditeljici istraživanja kolegici dr. sc. Kristini Jelinčić Vučković na pozivu na suradnju i ustupanju srednjovjekovnih nalaza za obradu i objavu.

1 We would like to thank the head of the research, our colleague Kristina Jelinčić Vučković PhD, for an invitation to take part in this project as well as for allowing us to interpret and publish the subject medieval finds.

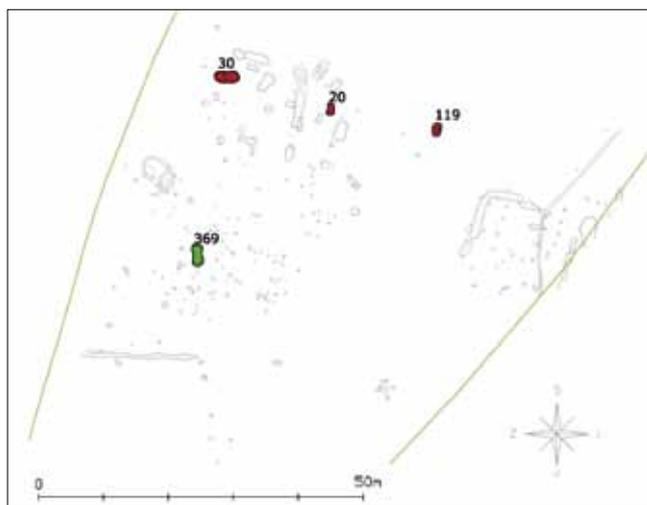

Sl. 211a Situacijski plan nalazišta Virovitica Kiškoriya jug s označenim arheološkim cjelinama: horizont I – crveno; horizont II – zeleno: krajnji sjeverni dio nalazišta

Fig. 211a Layout of Virovitica Kiškoriya south site with the marked archaeological units: horizon I – red; horizon II – green: the furthest northern part of the site

strane lokaliteta (SJ 1178, 1212, 1236, 1242, 1062/2030). U tim objektima pojavljuju se lonci jednostavne profilacije koso odsječnog ili zaobljenoga ruba. Najučestaliji način ukrašavanja je češljastim predmetom, odnosno, prisutan je motiv češljaste valovnice i snopova ravnih vodoravnih linija, a javlja se i motiv okomitih uboda načinjen također češljastim predmetom. Faktura tih posuda uglavnom je srednje kvalitete, kompaktne strukture.

Mlađi horizont naselja datira u kraj 9. i kroz 10. stoljeće. Keramički materijal ukazao je na potrebu lučenja horizonta IIa - kraj 9. i početak 10. stoljeća i horizonta IIb - druga trećina 10. stoljeća. Dva odsječka mlađeg horizonta definirana su na osnovi različitih značajki keramičkog materijala. Prvome odsječku mlađeg horizonta pripadaju objekti smješteni u južnijem dijelu istražene površine naselja (SJ 1358, 2152+2305, 1721, 1817), dok je zamjetno kako se u drugome odsječku mlađeg horizonta naselje nanovo širi prema sjeveru (SJ 369, 523, 621, 623, 629). Značajka keramike horizonta IIa jest učestalo ukrašavanje posuda kotačićem, sporadično zadržavanje ukrašavanja plitkom češljastom valovnicom, izostanak ukrašavanja okomitim ubadanjem češljastim predmetom te uvođenje ukrasa jednostruke valovnice na ramenu i nizova jednostrukih vodoravnih linija na trbuhu posude. Značajka keramike horizonta IIb jeste izostanak kotačića, učestalija primjena jednostruke valovnice i jednostrukih vodoravnih linija. Češljasta valovnica i dalje se koristi kroz čitavo vrijeme mlađeg horizonta, no značajka joj je to što je, za razliku od češljastih, ulijevo ukošenih i gustih amplituda na loncima iz starijeg horizonta s kraja 8. i iz 9. st., ona sada niskih i širokih valova. Kroz čitavo razdoblje mlađeg horizonta karakterističan je izostanak zaobljenih rubova jednostavne profilacije, odnosno

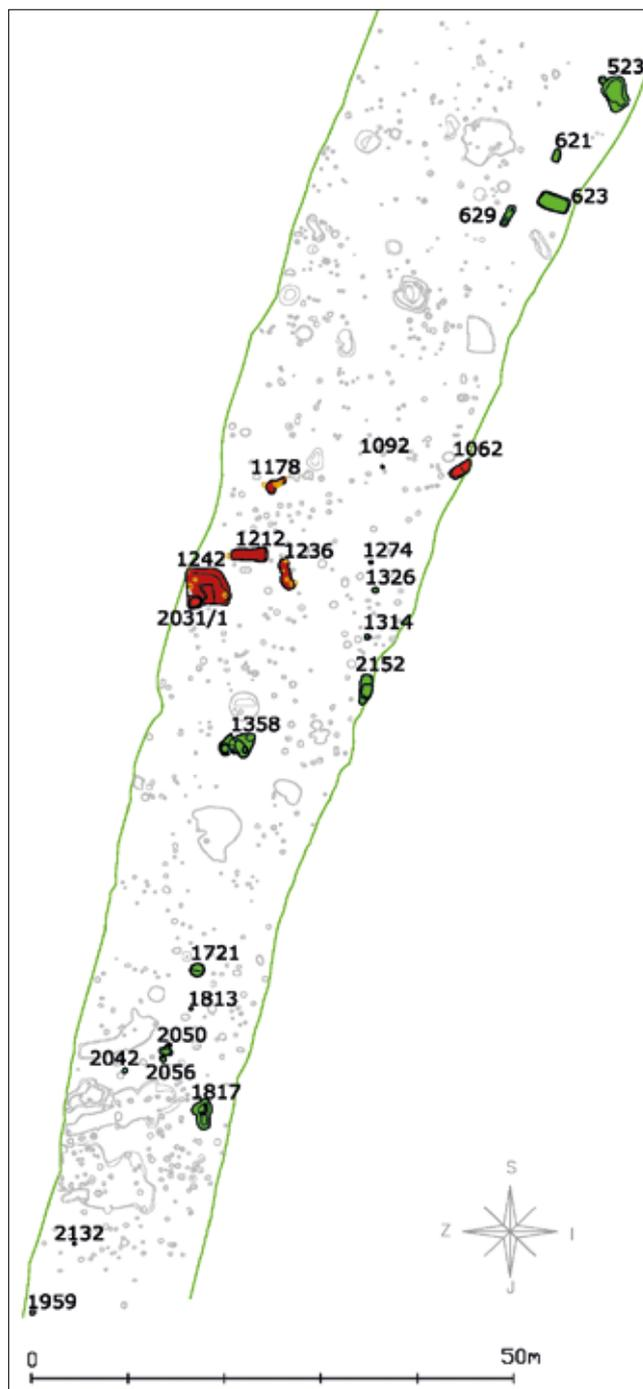

Sl. 211b Situacijski plan nalazišta Virovitica Kiškoriya jug s označenim arheološkim cjelinama: horizont I – crveno; horizont II – zeleno: središnji i južni dio nalazišta

Fig. 211b Layout of Virovitica Kiškoriya south site with the marked archaeological units: horizon I – red; horizon II – green: the central and the southern part of the site

one, divided into the horizon IIa – the late 9<sup>th</sup> and the early 10<sup>th</sup> century, and the horizon IIb – the second third of the 10<sup>th</sup> century (fig. 213).

The features at the northern side of the site (SU 20, 30, 119) and the ones at the central part of the southern side of the site (SU 1178, 1212, 1236, 1242, 1062/2030) belong to the older horizon. In these features, the pots of a simple



Kontekst (Stratigrafska jedinica)	Funkcija	Dimenzije (m)	Debjina zapune objekta	Minimalni broj posuda	Druge vrste nalaza	Horizont
19/20	ndefinirana namjena	1,20x1,90	0,34	5	lijep, životinjske kosti	I
29/30	kuća	3,80x1,80	0,24	8	lijep, spaljene životinjske kosti, zgura, žrvanj	I
118/119	ndefinirana namjena	1,43x2,10	0,49	8	lijep, spaljene životinjske kosti, željezno šilo	I
368/369	ndefinirana namjena	1,64x3,45	0,36	5	lijep, životinjske kosti, ulomci rimskog stakla, rimski pršljen	IIb
522/523	ndefinirana namjena	2,20x4,13	0,43	2 ulomka		IIb
620/621	ndefinirana namjena	0,77x1,42	0,57	4	lijep, ulomci rimskog stakla, zgura, kamen	IIb
622/623	ndefinirana namjena	3,31x1,80	0,24	10	zgura, lijep	IIb
628/629	ndefinirana namjena	0,76x2,47	0,26	4	ulomci rimskog stakla	IIb
1061/1062+2030	peč	2,35x1,15	0,72	5	lijep	I
1091/1092	stup	Ø 0,34	0,27	2 ulomka		II
1177/1178	ndefinirana namjena	2,30x1,30 (0,70)	0,20	11 ulomaka	lijep	I
1211/1212	ndefinirana namjena	3,75x1,55	0,59	6	žrvanj, lijep	I
1235/1236	ndefinirana namjena	1,17x3,38	0,20	4	lijep, kamen, šljunak	I
1241/1242+2031/1	kuća	4,45x4,40	0,18	4-5	željezna motika	I
1273/1274	stup	Ø 0,40	0,47	2 ulomka		II
1313/1314	stup	Ø 0,57	0,38	2 ulomka		II
1325/1326	stup	Ø 0,65	0,43	3-4	lijep, kamen	II
1357/1358+2027, 2029	kuća	3,40x2,55	0,62	14	lijep, kamen, šljunak, životinjske kosti	IIa
1720/1721	ndefinirana namjena	Ø 1,40	0,28	4	lijep, šljunak	IIa
1812/1813	stup	Ø 0,36	0,15			II
1816/1817	ndefinirana namjena	2,06x3,30	0,73	4-6	lijep	IIa
1958/1959	stup	0,56x0,44	0,34	4 ulomka		II
2041/2042	stup	Ø 0,50	0,24	1 ulomak		II
2049/2050	ndefinirana namjena	1,35 (0,50)x1,55	0,54		lijep	II
2055/2056	stup	0,70x0,60	0,15	2 ulomka		II
2131/2132	stup	Ø 0,32	0,23	2 ulomka		II
2151/2152+2305	peč	1,30x3,30	0,80	4	zgura, lijep	IIa

Sl. 212 Tablični prikaz svih srednjovjekovnih arheoloških cjelina i nalaza po horizontima



Context (Stratigraphical Unit)	Function	Dimensions (m)	Thickness of the backfill of the feature	Minimal number of vessels	Other findings	Horizon
19/20	undefined purpose	1.20x1.90	0.34	5	daub, animal bones	I
29/30	house	3.80x1.80	0.24	8	daub, burned animal bones, slag, whetstone	I
118/119	undefined purpose	1.43x2.10	0.49	8	daub, burned animal bones, iron awl	I
368/369	undefined purpose	1.64x3.45	0.36	5	daub, animal bones, fragments of roman glass, roman whorl	IIb
522/523	undefined purpose	2.20x4.13	0.43	2 fragments		IIb
620/621	undefined purpose	0.77x1.42	0.57	4	daub, fragments of roman glass, slag, stone	IIb
622/623	undefined purpose	3.31x1.80	0.24	10	slag, daub	IIb
628/629	undefined purpose	0.76x2.47	0.26	4	fragments of roman glass	IIb
1061/1062+2030	oven	2.35x1.15	0.72	5	daub	I
1091/1092	post	Ø 0.34	0.27	2 fragments		II
1177/1178	undefined purpose	2.30x1.30 (0.70)	0.20	11 fragments	daub	I
1211/1212	undefined purpose	3.75x1.55	0.59	6	whetstone, daub	I
1235/1236	undefined purpose	1.17x3.38	0.20	4	daub, stone, gravel	I
1241/1242+2031/1	house	4.45x4.40	0.18	4-5	iron matock	I
1273/1274	post	Ø 0.40	0.47	2 fragments		II
1313/1314	post	Ø 0.57	0.38	2 fragments		II
1325/1326	post	Ø 0.65	0.43	3-4	daub, stone	II
1357/1358+2027, 2029	house	3.40x2.55	0.62	14	daub, stone, gravel, animal bones	IIa
1720/1721	undefined purpose	Ø 1.40	0.28	4	daub, gravel	IIa
1812/1813	post	Ø 0.36	0.15			II
1816/1817	undefined purpose	2.06x3.30	0.73	4-6	daub	IIa
1958/1959	post	0.56x0.44	0.34	4 fragments		II
2041/2042	post	Ø 0.50	0.24	1 fragment		II
2049/2050	undefined purpose	1.35 (0.50)x1.55	0.54		daub	II
2055/2056	post	0.70x0.60	0.15	2 fragments		II
2131/2132	post	Ø 0.32	0.23	2 fragments		II
2151/2152+2305	oven	1.30x3.30	0.80	4	slag, daub	IIa

Fig. 212 Tabular presentation of all medieval archaeological units and findings per horizons



Lokalitet Site	SJ SU	Radiokarbonska starost Radiocarbon Age	Kalibrirana starost Calibrated Age	1 sigma raspon One Sigma Range	2 sigma raspon Two Sigma Range
VIROVITICA KIŠKORIJA JUG VIROVITICA KIŠKORIJA SOUTH	29	BP 1196 ± 27	cal AD 783, 789, 828, 840, 863	cal AD 781 - 784 (2.7 %) cal AD 786 - 792 (6.1 %) cal AD 808 - 880 (59.5 %)	cal AD 727 - 737 (1.9 %) cal AD 773 - 895 (91.6 %) cal AD 924 - 938 (1.9 %)
	118	BP 1224 ± 34	cal AD 779	cal AD 725 - 739 (8.2 %) cal AD 772 - 784 (7.5 %) cal AD 788 - 832 (29.4 %) cal AD 837 - 876 (23.2 %)	cal AD 690 - 703 (2.9 %) cal AD 709 - 752 (17.3 %) cal AD 759 - 890 (75.2 %)
	368	BP 1117 ± 28	cal AD 900, 919, 959	cal AD 895 - 905 (9.6 %) cal AD 906 - 924 (18.4 %) cal AD 939 - 977 (40.3 %)	cal AD 882 - 997 (95.4 %)
	1211	BP 1242 ± 24	cal AD 776	cal AD 692 - 700 (4.1 %) cal AD 715 - 750 (31.7 %) cal AD 764 - 782 (15.9 %) cal AD 791 - 811 (11.7 %) cal AD 844 - 854 (4.8 %)	cal AD 689 - 705 (6.7 %) cal AD 705 - 754 (36.3 %) cal AD 757 - 784 (19.1 %) cal AD 788 - 833 (20.0 %) cal AD 837 - 877 (13.4 %)
	1357	BP 1168 ± 29	cal AD 888	cal AD 782 - 791 (6.8 %) cal AD 810 - 844 (21.2 %) cal AD 855 - 896 (29.4 %) cal AD 923 - 940 (10.9 %)	cal AD 778 - 902 (74.4 %) cal AD 917 - 962 (21.0 %)

Sl. 213 Rezultati radiokarbonskog datiranja uzoraka iz pojedinih cjelina (Leibniz Labor für Altersbestimmung und Isotopenforschung, Christian-Albrechts Universität, Kiel)

Fig. 213 Results of radiocarbon dating of samples from individual units (Leibniz Labor für Altersbestimmung und Isotopenforschung, Christian-Albrechts Universität, Kiel)

rubovi su u ovom horizontu prema unutra koso odsječeni, a zamjetno je i naglašavanje ramena posuda.

Od svih u srednji vijek opredijeljenih cjelina tek se tri mogu s većom sigurnošću pripisati stambenim objektima, a samo je jedna bila očuvana u tolikoj mjeri da je pružila dovoljno elementa za tipološko određenje (Sekelj Ivančan, Tkalčec 2008: 116, Fig. 4, Fig. 6). Radi se o arheološkoj cjelini SJ 1241/SJ 1242, koja je posebno izdvojena i sagledana u svom prostornom rasporedu, kako bi se na temelju očuvanog i istraženog pokušalo rekonstruirati karakterističan oblik ranosrednjovjekovnog stambenog objekta na ovom nalazištu (Sekelj Ivančan, Tkalčec 2010). Očuvani dio blago ukopanog objekta bio je nepravilno kvadratičnog tlocrta dimenzija 4,45 x 4,40 m (SJ 1242) s ognjištem dimenzija 1,41 x 1,43 u jugozapadnome uglu (SJ 2031/1) (sl. 214). Ognjište se sastojalo od crne gorevine i urušene strukture od komada crveno zapečene zemlje, a u njemu je pronađena željezna motika. Unutar gabarita objekta isticala su se dva ukopa (promjera 50–55 cm) za veće stupove koji se nalaze na međusobnoj udaljenosti od 3,90 m, te dva manja stupa (promjera 30–33 cm), međusobno udaljeni 3,40 m. Po čitavoj površini objekta pronađeno je mnoštvo lijepa koji ukazuje na to da su stijene kuće bile omazane blatom, dok mu podnica nije bila ušćuvana. Sagledavši arheološki istraženu cjelinu sa svim njezinim elementima, iznesen je prijedlog rekonstrukcije njenog izvornog oblika gdje se zaključuje da je kuća bila četvrtastog oblika tlocrta, blago ukopana ispod okolne

profile, with an obliquely truncated or rounded rim, appear. The most common way of decorating is achieved by use of a comb-like object, i.e. the decorative motive is the one consisting of both wavy lines and the bundles of straight horizontal lines; however, a motive of vertical stitches made with a comb-like object can be seen as well. The fabric of these vessels is usually of a medium quality and compact in its structure.

The younger horizon of the settlement dates from the late 9<sup>th</sup> and the 10<sup>th</sup> century. The analyzes of the ceramic material demonstrated the need of dividing it into the horizon IIa – the late 9<sup>th</sup> and the early 10<sup>th</sup> century and the horizon IIb – the second third of the 10<sup>th</sup> century. These two sections of the younger horizon are defined on the basis of various features of the ceramic material. The features located on the southern part of the excavated area of the settlement (SU 1358, 2152 + 2305, 1721, 1817) belong to the first section of the younger horizon, while it is evident that in the second section of the younger horizon the settlement stretches to the north (SU 369, 523, 621, 623, 629). The main feature of ceramics from the horizon IIa is recurrent decoration of pots with decoration made by small wheel in several rows, sporadic shallow combed wavy lines, lack of vertical stitches made with the comb-like object and the introduction of a single undulating decoration on the shoulder and rows of single horizontal lines on the body of the vessel. The main characteristic of the ceramics from



Sl. 214 Rekonstrukcija kuće SJ 1242, kraj 8. –kraj 9. st. (prema Sekelj Ivančan, Tkalčec 2010)

Fig. 214 Reconstruction of a house SU 1242, late 8<sup>th</sup>–late 9<sup>th</sup> century (according to Sekelj Ivančan, Tkalčec 2010)

342

hodne površine. Po jedan duboko ukopani stup na sredini svakog zabatnog zida činio je nosivu osnovu krovne konstrukcije, čije strane krovništa naliježu na bočne, blago uzdignute drvene zidove. Zidovi kuće zasigurno su bili građeni od drvene konstrukcije omazane blatom, a krov je vjerojatno bio prekriven slamom. Na osnovi pak ranije provedene analize keramike te analogija s ulomcima keramičkih posuda iz objekata apsolutno datiranih radiokarbonskim ispitivanjima (SJ 118) (sl. 213, 215), zaključeno je da kuća, iako je imala iznimno mali broj keramičkih ulomaka od kojih je razlučeno svega 4-5 različitih posuda, pripada prvom horizontu naselja, odnosno da potječe iz razdoblja od kraja 8. do kraja 9. stoljeća (Sekelj Ivančan, Tkalčec 2008: 115–116).

Pri ranijim objavama nalazišta *Virovitica Kiškorija jug*, malobrojni željezni predmeti koji potječu iz ranosrednjovjekovnih objekata bili su u postupku konzervacije te se njihova obrada donosi ovom prigodom. Radi se prvenstveno o nalazu željezne motike (sl. 216, 217: 1) iz poluukopane ranosrednjovjekovne kuće s ognjištem (SJ 1241/SJ 1242+SJ 2031/1). Okolnosti pronalaska prema kojima je motika bila u vrlo lošem stanju očuvanosti, pronađena u



Sl. 215 Rekonstruirani lonci iz SJ 118, kraj 8.–kraj 9. st.

Fig. 215 Reconstructed pots from SU 118, late 8<sup>th</sup>–late 9<sup>th</sup> century

the horizon IIb is an: absence of the decoration made by small wheel and more frequent use of a single wavy and horizontal lines. Comb-like wavy line is continuously used throughout the younger horizon, but now it has lower and broader waves, unlike the combed, left-slanting and dense amplitudes on the pots from the older horizon from the late 8<sup>th</sup> and the 9<sup>th</sup> century. Throughout the entire period of the younger horizon the absence of simply moulded rounded rims is characteristic, that is, in this horizon the rims are cut obliquely inward, and shoulders of vessels are noticeably emphasized.

Of all the units dated to the Middle Ages only three can, with greater certainty, be described as residential facilities, and only one was enough preserved to provide sufficient material for typological determination (Sekelj Ivančan, Tkalčec 2008: 116, fig. 4, fig. 6). The unit in question is an archaeological unit SU 1241 / SU 1242, which is singled out and viewed separately in its own spatial arrangement in an attempt to reconstruct the characteristic form of an early medieval residential facility at this site based on the preserved and researched elements (Sekelj Ivančan, Tkalčec 2010). A preserved part of the slightly buried house is an irregular 4.45 x 4.40 m square (SU 1242) with a fireplace measuring 1.41 x 1.43 in the southwest corner (SU 2031/1) (fig. 214). The fireplace consisted of black soot and collapsed structure made of red burnt earth; an iron mattock was found in it as well. Within the perimeter of the feature, two large post-cuts, 50 to 55 cm in diameter (distance between the two being 3.90 m) can be distinguished, as well as two smaller posts (30–33 cm in diameter), at a distance of 3.40 m between them. The entire surface of the feature was filled with a heap of daub which indicates that the walls of the house were plastered with mud; the flooring is not preserved.

Having observed an archaeologically explored unit together with all its elements, a proposal of the reconstruction of its original form has been presented, which shows that the house had a square-shaped layout, and that it was buried somewhat under the surrounding walking surface. In the middle part of each gable wall there was one deeply dug-in post and together they constituted the supporting basis of the roof structure, the sides of which are leaning on the lateral, slightly raised wooden walls. The walls of the house must have been built of wooden structures coated with mud, and the roof was probably covered with straw. Based on the previously conducted pottery analyzes and analogies with fragments of ceramic vessels from the facilities positively dated by radiocarbon probes (SU 118) (fig. 213, 215), it was concluded that the house, although it had a very small number of pottery fragments of which only 4-5 different vessels were distinguished, belongs to the first horizon of the settlement, i.e. from the late 8<sup>th</sup> to the late 9<sup>th</sup> century (Sekelj Ivančan, Tkalčec 2008: 115–116).



jugoistočnom dijelu urušenja ognjišta, odnosno vjerojatnije glinene peći unutar kuće, među komadićima zapečene zemlje, ne pružaju dovoljno elemenata za konkretan zaključak o razlogu takove pozicije unutar peći i objekta. Nadalje, utilitarni predmeti poput motika su izuzetno slabo tipološko-kronološki osjetljivi. Oblik i masivnost tog oruđa uvjetovana je vrstom tla ili poljoprivrednom kulturom te se određene značajke tih predmeta nepromijenjene ili blago modificirane zadržavaju kroz duže vremensko razdoblje. Primjerice, širina oštrice ovisila je o vrsti tla pri čemu je za tvrdu zemlju potrebna deblja, uža i duža alatka, dok se za rahlu zemlju upotrebljava šira i kraća oštrica. Također je poznato iz etnoloških izvora da su uske motike bile korištene za okopavanje vinograda i hortikulturnu obradu tla, dok su motike sa širokom oštricom bile korištene u vrtlarstvu i poljodjelskoj obradi tla (Pleterski 1987: 278–281, sl. 35). Iako skromni arheobotanički ostaci, zastupljeni tek s jednim karboniziranim ostatkom pšena obične pšenice iz zapune kuće te nekoliko ostataka kultiviranih žitarica koje nije bilo moguće preciznije odrediti iz zapune jednog od potpornih stupova (vidi poglavlje 5.2.: Tablica: Srednji vijek), ipak nam ukazuju na poljodjelske aktivnosti stanovnika Kiškorije, čemu u prilog ide i ovaj nalaz motike sa širokom oštricom. Alatka je korištena negdje u vremenu od kraja 8. do kraja 9. stoljeća, kada je datiran objekt iz kojeg potječe (Sekelj Ivančan, Tkalčec 2008; 2010), a valja zamijetiti da se velika većina kultiviranih biljaka, prvenstveno raznih vrsta žitarica (vidi poglavlje 5.2.: Tablica: Srednji vijek) pojavljuje u objektima opredijeljenima u stariji horizont naselja (Sekelj Ivančan, Tkalčec 2008: fig 4) kada je ratarstvo očito predstavljalo jednu od osnovnih djelatnosti stanovnika Kiškorije. Tome u prilog idu i pojedinačni nalazi žrnjeva u objektima SJ 30 i SJ 1212.

Drugi metalni predmet koji se ovom prigodom donosi potječe iz arheološke cjeline SJ 118/119 kojoj nije ustanovljena primarna funkcija. Iz te cjeline potječe mnoštvo keramičkih nalaza (sl. 215) prema kojima je vremenski opredijeljen, kao i uz pomoć <sup>14</sup>C datacije, u vrijeme starijeg horizonta naselja tj. od kraja 8. do kraja 9. stoljeća. Metalni predmet (sl. 217: 2) koji potječe iz ove cjeline željezo je šilo šireg kvadratnog presjeka sredinom predmeta i užeg na krajevima. Kao predmet on također nije kronološki osjetljiv i pojavljuje se nepromijenjen tijekom više stoljeća. Šila su poznata iz različitih arheoloških ranosrednjovjekovnih cjelina s područja sjeverne Hrvatske te su učestalo upotrebljavana u svakodnevnom životu (Sekelj Ivančan 2010b: 143–144).

Arheologija je svojim specifičnim metodama dala i na primjeru Virovitice Kiškorije jug vrijedan doprinos poznavanju života ranosrednjovjekovnih zajednica, što za naše područje danas još uvijek predstavlja veliku nepoznanicu. Uzrok tomu može biti i slaba očuvanost ranosredn-

When the results from *Virovitica Kiškorija south* site were previously published, few iron objects dating from the early medieval features were in the process of conservation so that their interpretation is presented herein. The major find is an iron mattock (fig. 216, 217: 1) from an early medieval half-buried house with a fireplace (SU 1241/SU 1242 + SU 2031/1). The circumstances of the discovery prove that the pick was in a very poor state of preservation and that it was found in the south-eastern part of the collapsed fireplace, or, more likely, in the clay oven inside the house, among pieces of burnt clay; however, they do not provide enough elements for assumptions as to why it was found in such a position inside the fireplace and the house itself. Furthermore, utilitarian items such as mattocks are extremely imperceptible, both typologically and chronologically. The shape and heftiness of this tool depend on the type of soil and agricultural crops for which it was used, so that the specific features of these objects remain to be unchanged or only slightly modified over a long period. For example, the width of the blade depended on the type of soil; hard soil required a thicker, narrower and longer tool, whereas loose earth required wider and shorter blades. Ethnological sources show that narrow mattocks were used for cultivating vineyards and for horticultural activities, while mattocks with a wider blade were used for gardening and agricultural tillage (Pleterski 1987: 278–281, fig. 35).

Although the archaeobotanical remains from the backfill of one of the posts are scarce and represented only by one carbonized common wheat grain found in the backfill of the house, and few remains of cultivated grains which could not be accurately determined, (see chapter 5.2.: Table: Middle Ages), they do point to agricultural activities of the population of Kiškorija, which is also supported by this finding of a wide-bladed mattocks. This tool was in use sometime between the late 8<sup>th</sup> to the late 9<sup>th</sup> century, i.e. to a period to which the object from which it originates is dated (Sekelj Ivančan Tkalčec 2008; 2010); however, it should be noted that the vast majority of cultivated plants, primarily various types of cereals (see chapter 5.2.: Table: Middle Ages) occur in the facilities dated to the older horizon of the settlement (Sekelj Ivančan, Tkalčec 2008: fig. 4) when the farming apparently presented one of the principal activities of the Kiškorija population. This is corroborated by individual whetstones found in features SU 30 and SU 1212.

Another metal object which is interpreted on this occasion originates from the archaeological unit SU 118/119, and its primary function has not been established. A large assembly of ceramic finds (fig. 215) is found in this unit, according to which it was dated, as well as with the help of <sup>14</sup>C analyses, to the older horizon of the settlements, i.e. to a period from the late 8<sup>th</sup> to the late 9<sup>th</sup> century. Metal





jojkovnog horizonta na našem tlu, ali i slaba istraženost, odnosno nedostatak adekvatnog broja ciljanih arheoloških istraživanja.

Ranosrednjovjekovno stanovništvo je na položaju Virovitica Kiškorija jug, na temeljima starijeg antičkog ruralnog naselja oblikovalo svoje naselje koje je egzistiralo u razdoblju od kraja 8. do kraja 10. stoljeća. Bilo je to tipično ruralno otvoreno naselje raštrkanoga tipa koje je preferiralo blago povišene padine brijega u okolini koja obiluje vodotocima i plodnim tlom. Uz nekoliko stambenih polukopanih objekata oko kojih su bili grupirani objekti, vjerojatno gospodarske ili neke druge namjene seoskih domaćinstava, pronađene su i peći, što nam sve zajedno pruža sliku infrastrukture ovog ranosrednjovjekovnog naselja. Osobito se u starijem horizontu naselja iščitava orijentiranost stanovništva poljoprivredi i obradi tla. Tome u prilog govore nam i nalazi ulomaka kamenih žrvnjeva te željezna motika. Arheobotanički ostaci žitarica pronađeni su u raznim objektima uglavnom starijeg horizonta, a najveći broj ih potječe iz peći SJ 1062, koja bi se po toj osnovi možda mogla interpretirati krušnom peći. U mlađem horizontu je stanovništvo vjerojatno i dalje bilo uvelike orijentirano na poljoprivrednu proizvodnju hrane, a zasigurno je i uzgoj domaćih životinja predstavljao izvor prehrane (meso, mlijeko i mliječne prerađevine), iako su nam zooarheološki nalazi iz arheoloških istraživanja malobrojni te sigurnije zaključke nije moguće donositi.

Iako istraženim opsegom malo, ranosrednjovjekovno naselje Kiškorija jug dalo je vrijedne podatke o načinima funkcioniranja ruralne ranosrednjovjekovne zajednice na području Podravlja pa i čitave sjeverne Hrvatske, a svako daljnje istraživanje i objava drugih nalazišta predstavljat će daljnji značajan doprinos u stvaranju cjelovitije slike o ranosrednjovjekovlju Hrvatske.



Sl. 216 Motika iz SJ 1242, kraj 8–kraj 9. st.

Fig. 216 Mattock from SU 1242, late 8<sup>th</sup>–late 9<sup>th</sup> century

item (fig. 217: 2) which originates from this unit is an iron awl with a wide square cross-section at its middle and the narrower one at the ends. As an item it is also not chronologically sensitive and appears unchanged over the centuries. The awls are common in a variety of early medieval archaeological units in northern Croatia and are frequently used in everyday life (Sekelj Ivančan 2010b: 143–144).

The Virovitica Kiškorija south site is yet another fine example of a valuable contribution of specific archaeological methods in better understanding of early medieval community life, which is in our case still unexplored. The reason for this being so can be a rather poor preservation of early medieval horizon in our region, as well as insufficient researches and lack of adequate number of targeted archaeological explorations.

The early medieval population at the Virovitica Kiškorija south site formed its settlement, which existed between the late 8<sup>th</sup> and the late 10<sup>th</sup> century, on the foundations of an older ancient rural settlement. It was a typical rural settlement of an open scattered type, a type which was usually located on slightly elevated slopes of a hill in an environment rich with streams and fertile soil. Alongside several residential half-buried houses, around which other features were grouped, probably production or other purpose facilities, ovens were also found, which, as a whole, gives a picture of the infrastructure of an early medieval settlement. The inclination of the population towards agriculture and tillage is particularly evident in the older settlement horizon. This is supported by findings of fragments of whetstones and an iron mattocks. The archaeobotanical remains of grains were found in various facilities, mainly in the older horizon, and most of them originate from the oven SU 1062, which could be on that basis interpreted as the bread oven. In the younger horizon population was probably still largely oriented toward agricultural production of food, and the breeding of domestic animals was certainly a source of food (meat, milk and milk products), although the zooarchaeological finds resulting from the archaeological excavations are scarce so that it is not possible to make definite conclusions.

Although its explored perimeters are small, the early medieval settlement Kiškorija south yielded valuable information about the functioning of the early medieval rural communities in Podravlje and in the entire northern Croatia as well, and any further research and publication of other sites will represent an additional significant contribution to creating a fuller picture of Croatian early Middle Ages.



## KATALOG:

1. Motika, željezo (sl. 216; 217: 1)  
SJ 2031; □ H 27; S-XXI; PN-57 (▼118,29 m)  
Motika se sastoji od nasada za dršku i oštrice. Nasad za dršku je duge osnovice, pravilnog pravokutnog oblika i kvadratnog presjeka. Rupa za nasad drvene drške je pravilnog, ovalnog oblika i nalazi se u donjoj polovini nasada, bliže oštrici motike. Na vanjskim stranama nasada, na dijelu gdje se nalazi rupa, stranice su blago zaobljene. Oštrica je nepravilnog trapezoidnog oblika. Na jednoj strani je u gornjem dijelu zaobljena, a na drugoj oštrokutnog prijelaza u užu dio oštrice.  
Dimenzije: cjelovita duž. 25,5 cm; nasad za držalo vis. 8,5 cm, šir. 3 cm, unutarnja šir. rupe za nasad 2,5x3,6 cm; oštrica max. šir. 18,3 cm, min. šir. 8 cm; očuvana vis. oštrice 17 cm, tež. 1374,3 g.
2. Šilo, željezo (sl. 217: 2)  
SJ 118; □ T 31; S-VI zapad; N-198  
Predmet nepravilno kvadratnog presjeka, u sredini širi, pri krajevima tanji, pri jednom djelomično očuvanom kraju tanji, vrhovi nedostaju  
Dimenzije: duž. 6,2 cm; max. šir. 0,3 cm; tež. 1,1 g.

## CATALOGUE:

- 1 Mattock, iron (fig. 216; 217: 1)  
SU 2031; □ H 27; A-XXI; SF-57 (▼118. 29 m)  
The mattock consists of a central eye for the shaft and the blade. The head has a long base, rectangular shape and square section. The central eye for the wooden shaft is oval and located in the lower half of the head, closer to the blade. On the outer sides of the head, where the hole is positioned, the sides are slightly rounded. The blade is shaped as an irregular trapezoid. It is rounded at the top on one side, and on the other it has a sharp transition to a narrower part of the blade.  
Dimensions: overall length 25.5 cm; head height. 8.5 cm, width. 3 cm, inner width of the central eye 2.5x3.6 cm; max. width of the blade 18.3 cm; min. width 8 cm; preserved height of the blade 17 cm, weight 1374.3 g.
- 2 Awl, iron (fig. 217: 2)  
SU 118; □ T 31; A-VI west; F-198  
The item has an irregular square cross-section, it is broader in the middle and thinner at its ends, thinner on one partially preserved end, tips missing  
Dimensions: length 6.2 cm; max. width 0.3 cm; wt. 1.1 g.



346

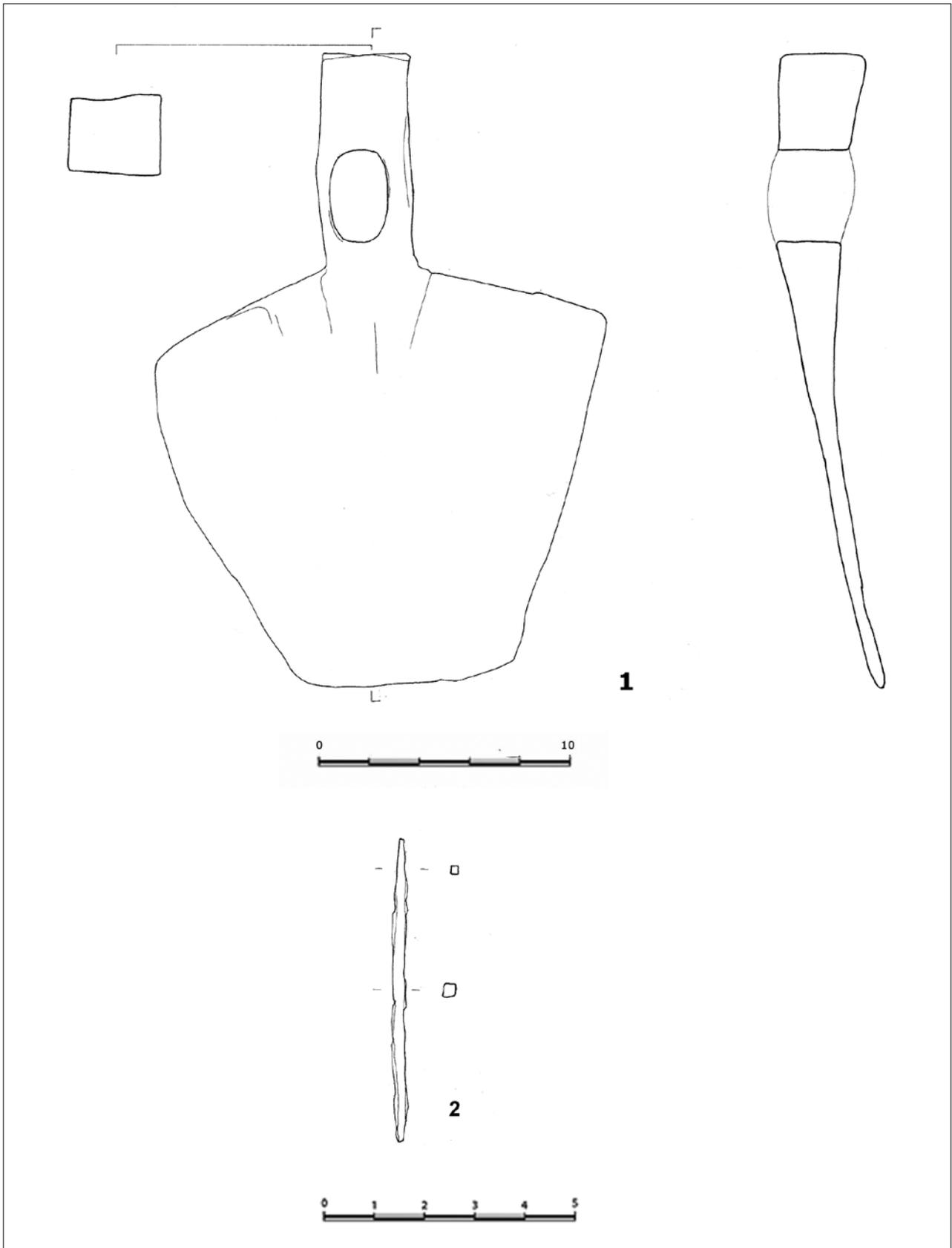

Sl. 217 1 - Željezna motika iz SJ 1242; 2 - željezno šilo iz SJ 118, kraj 8.-kraj 9. st.  
Fig. 217 1 - Iron mattock from SU 1242; 2 - Iron awl from SU 118, late 8<sup>th</sup>-late 9<sup>th</sup> century

IV DIO



PART IV



7.

*Virovitica Kiškorija Jug: primjer rimskog sela u Gornjoj Panoniji*

*Virovitica Kiškorija South: an example of a Roman village in the  
Upper Pannonia*





## Virovitica Kiškorija Jug: primjer rimskog sela u Gornjoj Panoniji

### Virovitica Kiškorija South: an example of a Roman village in the Upper Pannonia

Virovitica Kiškorija jug je rimsko selo smješteno u Gornjoj Panoniji, nedaleko od rijeke Drave i rimske ceste koja je spajala Petovij i Mursu. U kasnoj antici pripadalo je provinciji Panoniji Saviji. U nedostatku izvora i natpisa, iz opreza se govori o rimskom selu, budući da nema dovoljno elemenata za upotrebu naziva *vicus* ili *pagus*. Analiza arheoloških predmeta i <sup>14</sup>C analize pokazale su kako je naselje trajalo u kontinuitetu od početka 2. do početka 5. st., a obilježja pokretne i nepokretne građe ukazala su na jednostavnu organizaciju života koja se vidi u okrenutosti zajednice vlastitim resursima.

Način života (poluukopani objekti i kolibe od drva i blata) kao i lokalna, rukom izrađena keramika upućuju na snažne prapovijesne tradicije. Ukopani objekti, kao i kolibe, javljaju se kroz cijelo vrijeme trajanja naselja za razliku od sela pronađenih u Mađarskoj gdje su poluukopani objekti karakteristični za 1. i 2. st. (Leleković, Rendić-Miočević 2012: 296). Dosadašnje spoznaje govore u prilog činjenici kako se u južnopanonskim selima gradilo objekte od drva, s vrlo rijetkom upotrebom opeke. Na Kiškoriji nije pronađen kameni građevinski materijal, a pronađen je jedan jedini ulomak opeke. S obzirom na rezultate brojnih istraživanja rimskih sela tijekom posljednjih godina (Leleković, Rendić-Miočević 2012: 291, 293–301), možemo reći da je ovo selo bilo tipično za južnu Panoniju.

Zbog vrlo guste naseljenosti malog prostora u slučaju Virovitice Kiškoije jug, kontinuiranog popravljivanja i izgradnje novih objekata te malog broja arheoloških nalaza teško je iščitati jasan raspored objekata, definirati njihovu ulogu ili datirati ih, a ponekad je nemoguće razaznati unutarnju organizaciju prostora. Sjeverni dio lokaliteta, manje je gusto naseljen i na njemu se nešto jasnije naslućuju stambene i radne cjeline. Čini se kako nije postojao nekakav strogi raspored, za pretpostaviti je da su stambeno-radni prostori bili obiteljski organizirani. Što se tiče sjevernog dijela lokaliteta prisutan je manji diskontinuitet između 1. i 2. kompleksa. Na tom je mjestu prije istraživanja prolazio manji recentni kanal za navodnjavanje ili regulaciju voda te je njegovim iskopom, za pretpostaviti je, uništen dio lokaliteta te je prekid uzrokovan time, a ne organizacijom naselja. Prekid lokaliteta zabilježen je i u drugim rimskim selima, ali radi korištenja za radne aktivnosti koje su ugrožavale sigurnost

Virovitica Kiškorija south is a Roman village situated in Upper Pannonia not far away from the Drava River and a Roman road connecting *Poetovio* and *Mursa*. It belonged to the province of Pannonia Savia in the late antiquity. In absence of sources and inscriptions, it is cautiously referred to as a Roman village, since there are not sufficient elements to designate it as *vicus* or *pagus*. The analysis of archaeological objects and <sup>14</sup>C analysis showed that the settlement was active from the early 2<sup>nd</sup> century until the early 5<sup>th</sup> century; the characteristics of movable and immovable material point out to a simple organisation of life, which is evident in orientation of the community towards their own resources.

The way of life (half-buried structures and huts made of wood and mud), as well as locally produced hand-made ceramics, are the indication of a strong prehistoric tradition. Half-buried structures and huts had been present during the entire period of life of the settlement, unlike the villages found in Hungary where the half-buried structures are characteristic for the 1<sup>st</sup> and the 2<sup>nd</sup> century (Leleković, Rendić-Miočević 2012: 296). Present knowledge about the subject speaks in favour of the fact that wooden structures, with sporadic use of bricks, were built in villages of southern Pannonia. Only one single fragment of brick, and no stone, was found at the Kiškorija site. Based on the results on numerous researches of the Roman villages in the course of past years (Leleković, Rendić-Miočević 2012: 291, 293–301), we may say that this village was typical of the southern Pannonia.

In the case of the Virovitice Kiškorije south site, due to a densely populated small area, continued repairs and construction of new structures, as well as due to a small number of archaeological finds, it is difficult to decipher clear distribution of structures, or define their role and date them exactly, and sometimes it is hard to recognise the internal organisation of the space. The northern part of the site was somewhat less populated, and residential and working units are somewhat clearer. It appears that there was no strict organisation of the space so that we can assume that the residential-working area was organised within individual families. When it comes to the northern part of the site, there is a slight discontinuity of the complex between the 1<sup>st</sup> and the 2<sup>nd</sup> century. Before the research, a small irrigation or regulation canal was there; it may be assumed that its construction destroyed a part of the site, so that the discontinuity could be ascribed to that fact and not to the organisation of the settlement. Similar discontinuity was noted in other Roman villages too, the reason being the use of certain areas for the activities





samog naselja (npr. radi vatre) ili radi unutarnje prostorne organizacije (Leleković, Rendić-Miočević 2012: 300–301).

Prema nekoliko izdvojenih stambenih kompleksa čini se kako se pojedini kompleks sastojao od kolibe ili poluukopanog stambenog objekta, radnih prostora i otpadnih jama. Na raširenost radnih prostora na lokalitetu upućuje i nalaz brusova, žrvnjeva, utega, pršljena i troske na više položaja odnosno, zaključuje se kako u selu nisu postojali usko specijalizirani pojedinci za određene djelatnosti, već su domaćinstava samostalna nastojala pribaviti ono što im treba i odraditi što je više moguće aktivnosti unutar svojeg domaćinstva.

Veliki broj stupova pronađenih na malom području (npr. sl. 7, 9–10) zadaje velike teškoće u analizi i onemogućava sigurnu i logičnu interpretaciju tog prostora. U stupovima često nije bilo nalaza, a ispunjeni su bili karakterističnom svijetlo sivom, pepeljastom zemljom, s malo gara i lijepa. Svi su izgledali isto i nije ih se moglo razdvojiti na temelju različitih zapuna ili kronološki osjetljivog materijala. Na sjevernom dijelu lokaliteta gdje je koncentracija stupova manja, uočava se kako su kolibe na svom užem dijelu (uglavnom s južne strane) imale ispred nekoliko dodatnih stupova koji su nosili nadstrešnicu nad ulazom. Takva se situacija ponavlja na više mjesta, ne nužno s istom orijentacijom. Takve nadstrešnice pronađene su i na lokalitetu Schwabmünchen (Moosbauer 1999: 224, Abb. 4). Slična pojava, interpretirana kao trijemovi ispred koliba, otkrivena je na lokalitetima Invandvor i Josipovac gdje je dovedena u vezu s germanskom populacijom, a na tim je lokalitetima pronađena i germanska karakteristična keramika ukrašena pečatima (Leleković, Rendić-Miočević 2012: 296) što na Kiškoriiji nije slučaj.

Pronađene su dvije strukture za pripremu hrane (fr. *table à feu*) i ognjišta. Najbolje očuvan primjer strukture za kuhanje je SJ 630/631 gdje su očuvani masivni ulomci lijepa s mnoštvom ostataka hrane. To govori u prilog kako je nad jamama bila sagrađena manja konstrukcija od šiblja obložena blatom s ravnom površinom na vrhu na kojoj se kuhalo, nalik velikim rimskim kuhinjama, ali prilagođenim seoskim prilikama i manjem domaćinstvu. Strukture za kuhanje i ognjišta pronađene su uvijek izvan objekata. Ne treba zaboraviti kako je lokalitet vrlo loše očuvan, odnosno kako je gornji dio izoran. Budući da su objekti očuvani vrlo plitko, moguće je kako su originalno te strukture činile dio zatvorenih objekata, a izoravanjem ta je veza uništena. Poluukopani objekti s krušnim pećima i ognjištima na rubu pronađeni su u panonskim selima Invandvor i Šepkovčica, s bunarom u središtu objekta (Leleković, Rendić-Miočević 2012: sl. 26–27, 296, 299–300). Ognjišta su na Kiškoriiji također pronađena izvan objekata, a očuvana su kao zapečena dna jama s manjom i ili većom količinom lijepa. Ognjišta su čest nalaz u rimskim selima, dok je nalaz strukture za pripremu hrane za sada, barem u hrvatskim okvirima izuzetak.

U selu je pronađen samo jedan bunar koji je pouzdano

that might jeopardise the security of the village (e.g. fire) or the internal reorganisation of the space (Leleković, Rendić-Miočević 2012: 300–301).

According to few separate residential complexes it would appear that individual complexes consisted of a hut or a half-buried residential structure, working areas and waste pits. Distribution of working areas at the site is also indicated by the finds such as whetstones, grindstones, weights, whorls and slag at a number of locations, i.e. one might draw a conclusion that there were no individuals specialised for certain activities, but rather that the households strived on their own in acquiring their bare necessities and in producing as much as they could by themselves.

Many posts found in a relatively small area (e.g. fig. 7, 9–10) complicate the analysis, making it impossible to interpret the area logically and with certainty. Very often the posts contained no finds; they were filled with characteristic light-grey ashy earth with some soot and daub. They all looked the same and they could not have been differentiated based on different filling material or chronologically sensitive material. In the northern part of the site, where the concentration of the posts was not that great, one can notice that the huts had few additional posts at the front (mostly at the south) which carried a shed at the entrance. This can be seen on several locations, but not necessarily with the same orientation. Similar sheds have been found at the Schwabmünchen site (Moosbauer 1999: 224, Abb. 4). The same type of sheds has been found at Invandvor and Josipovac, where it was decided that it had to do with the German population there; the German ceramics decorated with sigilla was also found at those sites (Leleković, Rendić-Miočević 2012: 296), but not at the Kiškoriija site.

Two objects used for food preparation (fr. *table à feu*) and hearths were found as well. The best preserved example of a cooking structure is SU 630/631, where the massive fragments of daub were preserved, along with the remnants of food. It confirms the assumption that a smaller structure made of wicker and mud, with smoothed upper surface, which served as a cooker, was erected above the pits; this resembles big Roman kitchens, only here the kitchens were adapted to the conditions prevailing in the village and to needs of a smaller household. These kitchens and hearths have always been located outside the residential building. One should bear in mind that the site is poorly preserved, with the top layer ploughed. Since the preserved structures were covered with a thin layer of soil, it is possible that these structures had originally been a part of enclosed object the top of which was destroyed by prolonged ploughing. Half-buried objects with baker's ovens and hearths at their perimeter with the wells in the centre were found in the villages of Invandvor and Šepkovčica (Leleković, Rendić-Miočević 2012: fig. 26–27, 296, 299–300). The hearths at the Kiškoriija site were also found outside the objects; they are preserved as the fired bases of pits with a smaller or larger quantity of daub in them: The hearths are often found in the Roman villages, whereas the facilities for food preparation have been rare in Croatia, at least for the time being.

Only one well, which positively belongs to the antiquity, was found in the village: SU 802/803 was detached, i.e.



antički: SJ 802/803, bio je samostalan tj. nije bio sastavni dio većeg objekta kao što je to bilo u slučaju Ivandvora i Šepkovčice. Drugi bunar nije imao arheoloških nalaza, a u trećem je pronađen veći ulomak novovjekovnog lonca. Rimski bunar je smješten u nižem dijelu terena i moguće je da je baš radi podzemnih voda (koje su otežavale pražnjenje zapune) ovdje iskopan kako bi osiguravao vodu.

Pojava rukom izrađene keramike nije izoliran slučaj, budući da su takvi nalazi česti na drugim selima uključujući i kasnoantičko razdoblje (Gabler 1990–1991: 19). Većina keramičkog repertoara pripada keramici lokalne proizvodnje koja se koristila u pripremi i čuvanju hrane, a vrlo mala količina pripada uvoznom posuđu. U lokalno izrađenom posuđu snažno su očuvane prapovijesne tradicije što je vidljivo u oblikovanju i načinu izrade. Analiza posuđa lokalne proizvodnje okolnih mikroregija pokazala je specifičnosti svakog od analiziranih područja, a posuđe s Virovitice Kiškorije jug uklapa se u obilježja posuđa mikroregije kojoj pripada: riječ je o posuđu jednostavnih oblika, pjeskovite i mekane strukture, vrlo tankog premaza, bez ukrasa, pečenom u neujednačenim uvjetima.

Stakleni predmeti su pronađeni u vrlo malom broju, a riječ je o ulomcima staklenog posuđa (vjerojatno čaše i boce). Pronađena je i manja količina staklenog nakita (naručnice) te nekoliko perlica koje nisu dovršene ili možda predstavljaju otpad.

Metalnih nalaza također nema mnogo. Riječ je o predmetima koji su služili u poljoprivredi, obrtu (kožarski, tarsarski, kovački obrt) i kućanstvu (razni noževi). Metal je bio skupocjen te se nije odbacivao već se reciklirao, kao i staklo. Manji dio predmeta pripada posuđu (cjedila i zdjela) te nakitu (fibule i prstenje). Pronađeno je 5 primjeraka novca od kojih 4 pripadaju kasnoantičkom razdoblju.

Kameni nalazi pripadaju uporabnim predmetima, a ne građevinskom materijalu. Pronađeni su ulomci dvaju žrvnjeva i šest brusova te predmeti izrađeni od rožnjaka. Jedan žrvanj izrađen je od vulkanske stijene i mogao je trgovinom doći s udaljenog kraja. Drugi žrvanj je, kao i svi brusovi, izrađen od stijene koja se može naći na obližnjem Papuku i nedaleko u Mađarskoj. Pojava predmeta od rožnjaka (odbojci i sječiva) ne može se sa sigurnošću objasniti. Prostorni i vremenski kontinuitet prapovijesnog kasnolatenskog i rimskog sela nisu dokazani već se o njima može samo spekulirati. Da je takav kontinuitet dokazan, prisutnost ove vrste nalaza bi bila logična i lako objašnjiva.

Malobrojni su predmeti koji su mogli predstavljati bogatstvo pojedinaca kao što su srebreni prsten, brončano posuđe i ne predstavljaju stvarno stanje dostupnosti takvih dobara širem sloju stanovnika u selu. Većina pronađenih arheoloških predmeta ipak pripada lako dostupnoj robi.

Pronađeni biljni ostaci govore kako su stanovnici lokaliteta jeli hranu koja se mogla prikupiti (kupina) i uzgojiti (ječam, proso, klipasti muhar, pir, pšenica, bob, šljiva...) u njihovoj neposrednoj okolini. Od žitarica su u najvećem

it was not a part of a larger structure, as it was the case with the wells in Ivandvor and Šepkovčica. The second well contained no archaeological finds, whereas the third one contained a considerably large fragment of pot from the New Era. The Roman well is situated in the lower area of the terrain and it is possible that it was located there because of the subterranean water flows (which made the excavation of the backfill material difficult).

The incidence of hand-made ceramics is not an isolated occasion, since such finds are quite frequent in other villages, late antiquity period included (Gabler 1990–1991: 19). Majority of the ceramics repertoire pertains to the locally produced ceramics used for preparation and preservation of food; only a small portion pertains to imported dishes. Locally produced dishes reflect prehistoric tradition, both in design and craftsmanship. The analysis of the locally produced dishes in the surrounding micro-regions showed the specificity of each of the analysed areas, while the dishes from the Virovitica Kiškorije south site are consistent with the features of the dishes from the respective micro-region; they are simple in design, of sandy and soft fabric, with very thin slip, without decoration, and fired under uneven conditions.

Only few glass items have been found; they are actually just fragments of glassware (probably cups and bottles). Few pieces of glass jewellery (bracelets) have also been found, as well as few unfinished beads or perhaps scrap material.

Metal finds are scarce as well. The items found had been used in agriculture, crafts (leather processing, carpentry, blacksmith), and in household (various knives). Metal was expensive and it was never discarded; instead it was recycled like glass. Fewer metal finds pertain to dishes (strainers and bowls) and jewellery (fibulae and rings). Five coins, four of which belong to the late Antiquity, were also found.

Stone finds belong to utility items rather than to construction material. Fragments of two whetstones, six grindstones and items made of chert have been found. One whetstone was made of a volcanic rock and could have been brought in through trade channels from far away. Second whetstone was made of rock common to the Papuk mountain or the area in nearby Hungary; the same rock was used to make the grindstones. The origin of the object made of chert (flints and blades) cannot be explained with certainty. Spatial and temporal continuity of prehistoric late La Tène and Roman village has not been proven and it remains to be a subject of speculation. Had this continuity be proven, the presence of this type of finds would be logical and easily explicable.

Just a few items have been found that could speak of the wealth of their owners. A silver ring and bronze dishware are such items. However, they are not representative of an actual situation of their accessibility to general population in the village. Most of these archaeological objects fall into category of easily available goods.

Vegetal remnants that have been found tell us that the population living at this particular site consumed the food available (blackberries) or grown (barley, millet, foxtail millet, spelt, wheat, broad bean, plum...) in their proximate neighbourhood. Millet and barley are most common cereals; they were used for various types of dishes, gruels and



postotku pronađeni proso i ječam koji su se koristili u izradi različitih jela, kaša i pive i čine dio prehrane poznate sa sličnih antičkih lokaliteta, ali i iz antičkih izvora. Žitarice koje su pronađene u selu su očišćene od korova i kukolja te su pripremljene za skladištenje i konzumaciju. O poljoprivrednoj aktivnosti govori i nalaz željezne motike. Žitarice su se u samom selu i dalje obrađivale tj. radilo se brašno o čemu govori nalaz žrvnjeva. Ječam je također mogao služiti i kao krmivo što uz životinjske ostatke (govedo, svinja, ovca/koza) govori o životinjskom uzgoju. Životinje su bile izvor mliječnih i mesnih proizvoda, kože, ali su mogle služiti i kao radne životinje (govedo, konj, magarac). Najbrojnija su bila goveda, zatim koze/ovce, a nešto manje je pronađeno kornja/magaraca te svinja.

Među biljkama i životinjama nema nalaza koji bi nas svojom egzotičnošću iznenadili. Karakter arheoloških nalaza, koji je prije svega utilitarne prirode govori u prilog organizaciji života na selu koji se svodio na podmirivanje prije svega osnovnih funkcija: posjedovanje posuđa za kuhanje i spremanje te oruđa, a u manjoj mjeri finog stolnog posuđa za serviranje, nakita i staklenih predmeta.

Iz svega navedenog, vrlo je jasno da se selo nastojalo održati vlastitim snagama, da se oslanjalo na vlastite gospodarske i obrtničke aktivnosti. Na taj je način bilo samostalno, a samostalnost je vjerojatno bila ključ dugog trajanja ovog malog sela.

U potrazi za dubljim razlozima samostalnosti sela i ukorijenjenosti prapovijesnih tradicija potrebno je razmotriti i povijesne okolnosti.

Jugozapadni dio rimske Panonije bio je gusto naseljen prije dolaska Rimljana. Smirivanjem prilika u Panoniji dolazi do stabilizacije života i do njene romanizacije što podrazumijeva određene promjene u načinu i organizaciji svakodnevnog života. To se odnosi na izgradnju cesta, osnivanje rimskih sela i podizanje rimskih vila, ali i reorganizaciju postojećih naselja. Istraživanja u Srijemu, zabilježila su preživljavanje prapovijesnih sela do kraja 1. st. po. Kr. koja zadržavaju snažne prapovijesne tradicije u načinu stanovanja, proizvodnji keramike i ekonomiji (Brukner 1995a: 110). O preživljavanju keltskih naselja u Panoniji govore povijesni i epigrafski izvori te onomastička istraživanja (Gabler 1982: 61, 94; 1990–1991: 51), ali su nalazi natpisa s područja Jassa, gdje se nalazi Virovitica Kiškoriya jug, malobrojni, te ne omogućavaju detaljno istraživanje. Ne treba zaboraviti da nam oni sami po sebi ne mogu dati cjelovitu sliku i realan uvid o stanovništvu (Radman-Livaja, Ivezić 2012: 142, 144). Istraživanjem ruralnih naselja zabilježeni su i primjeri kada se keltska sela nisu mogla u potpunosti prilagoditi novim ekonomskim i političkim uvjetima pa su prestala postojati zbog toga, a ne zbog rata, razaranja ili pritiska (Gabler 1990–1991: 53–64).

Lokalitet *Szakály*, smješten južno od Balatona primjer je lokaliteta s kontinuitetom od kasnog latenskog razdoblja pa sve do početka 5. st. u punom kontinuitetu (Gabler 1982: 61, 94). Iako Virovitica Kiškoriya jug nema

beers; similar food was common in similar antiquity sites; antiquity sources often report on such food. Cereals found at the site are free of weeds and prepared for storage and consumption. An iron hoe which was found at the site speaks of agricultural activity. Cereals had been processed in the village, i.e. flour was produced, which is evidenced by the whetstones found in the village. Barley could have been used as foodstuff for domestic animals; this and animal remains (cattle, swine, sheep/goats) speak of animal breeding in the village. Animals were a source of dairy and meat products, as well as of leather; they were also used for various works (cattle, horse, donkey). The cattle prevailed, sheep and goats came next, whereas horses, donkeys and pigs were not that numerous.

Findings relating to plants and animals do not appear to be exotic at all. The character of archaeological finds, which is utilitarian by nature in the first place, illustrates the organisation of life in the village that is oriented towards satisfying people's basic functions: possession of dishes for cooking and storing; possession of tools, and to somewhat lesser degree possession of fine cutlery and kitchen utensils, jewellery and glass items.

All the facts hereinabove stated clearly indicate that the village strived to maintain itself on its own, that it depended on its own economic and crafts resources. This ensured its independence, which was probably the key to its longevity.

In a quest for deeper reasons of the village's independence and its prehistoric traditions one has to reconsider historical circumstances as well.

Southwest part of Roman Pannonia had been densely populated even before the Romans arrived. When the situation in Pannonia calmed down, the stabilisation of life ensued and Roman influence was prevailing, which, in turn, meant introducing certain modifications in the way of life and in the organisation of everyday activities. These activities included the construction of roads, setting up Roman villages, building Roman villas, as well as reorganisation of the existing settlements. The researches in Srijem confirmed the survival of prehistoric villages until the end of the 1<sup>st</sup> century; these villages retained strong prehistoric traditions when it comes to way of life, production of ceramics and economy (Brukner 1995a: 110). Historical and epigraphic sources, as well as onomastic researches (Gabler 1982: 61, 94; 1990–1991: 51), communicate about the survival of Celtic settlements in Pannonia, though the inscriptions from the Jassa area, where the Virovitica Kiškoriya south site is located, are rather scarce, thus making any detailed examination impractical. One should not overlook the fact that they alone cannot provide a complete account and realistic insight about the local population (Radman-Livaja, Ivezić 2012: 142, 144). Research of the rural settlements came up with the examples of the Celtic villages unable to completely adjust to new economic and political conditions, which led to their demise, this being the result of their inability to adapt, rather than wars, destructions or coercion (Gabler 1990–1991: 53–64).

The *Szakály* site, situated south of the Balaton Lake, is an example of the site with the continuity lasting from the late La Tène era until the beginning of the 5<sup>th</sup> century (Gabler 1982: 61, 94). Although the continuity of the Virovitica Kiškoriya south site from the times of the late La Tène can-



dokazan kontinuitet od vremena kasnog latena s lokalitetom *Szakály* pokazuje najviše sličnosti u odnosu na druge objavljene lokalitete. Te se sličnosti uočavaju u načinu stanovanja (oblikovanje stambenih prostora), minimalnom rimskom utjecaju i maloj količini uvezene robe. Primjerice, tarionici se na oba lokaliteta javljaju tek u kasnoj antici, a nije riječ o bilo kakvim posudama već o posudama za pripremu hrane koje se na ovom prostoru vežu isključivo za Rimljane i romanizaciju. Na oba lokaliteta također nisu pronađene lampice. Razlika između Virovitice Kiškorije jug u odnosu na *Szakály* je u tome što keramičke oblike prisutne od početka na Kiškoriji, nalazimo do kraja trajanja naselja uz minimalnu pojavu novih oblika (L7, 8), dok su u *Szakályu* u kasnoj antici takvi oblici malobrojni.

Brojna zaštitna istraživanja na trasama obilaznica, cesta i autocesta u sjevernoj Hrvatskoj otkrila su brojna rimska sela. Neka od njih imaju kontinuitet iz kasno latenskog do u rimsko razdoblje.

Nedaleko od Slatine pronađen je lokalitet Slatina - Veliko polje - Trnovača gdje je istraženo latensko i ranorimsko naselje s kontinuitetom do u 2. st. po. Kr. U rimskom selu nastavilo se s oblikovanjem objekata, organizaciji sela i izradi posuda na način na koji su to stanovnici radili i u kasno latenskom selu (Filipović 2010: 133). Kod Jakopovca u okolici Varaždina istražen je lokalitet Blizna na kojemu je pronađeno kasno latensko i rimsko naselje. U ovom je slučaju malo rimsko selo kontinuirano živjelo do kasne antike (Bekić 2006: 111–125, 128–132). Selo, datirano u 1. st. pr. Kr. i 1. st. po. Kr. zabilježeno je i u blizini Stružana (Lozok 2008: 105).

Među rijetko objavljenim podacima o rimskim selima s hrvatskog područja nalazi se potpuna objava iskapanog materijala sela iz druge polovine 1. st. kod Vinkovaca (*Liskovac*). Prema pronađenom materijalu, u tom su selu također očuvane prapovijesne tradicije. On je, slično kao i Kiškorija, smješten nedaleko od kasno latenskog naselja (gradine), a udaljeni su oko 1 kilometar (Ožanić Roguljić 2009: 79–80). Virovitica Kiškorija jug je udaljena od kasno latenskog sela Virovitica Kiškorija sjever još manje - oko 265 m. U oba slučaja nemamo direktni prostorni kontinuitet, ali ne treba zaboraviti kako su oba naselja istražena samo u onom dijelu kojim je prolazila trasa prometnice te smo zbog toga zaknuti za konačne podatke o trajanju tih naselja. Virovitica Kiškorija jug je, u odnosu na prapovijesno selo, smještena na 1–2 metra uzvišenijem položaju i bliža je rimskoj cesti Petovij-Mursa. S obzirom na prisutan diskontinuitet na Kiškoriji koji je objašnjen nepovoljnim položajem i zadržavanjem oborinskih te prisutnošću podzemnih voda, moguće je da je ova manja visinska razlika doprinijela ideji izmještanja novog sela, naravno, ukoliko je riječ o postojanju kontinuiteta. Na lokalitetu *Sela*, kraj Đakova, pronađeno je rimsko selo s drvenim kolibama koje je datirano od 1.–4. st. Lokalitet još nije objavljen u potpunosti, a prema dostupnim podacima vrlo snažna prapovijesna tradicija vidljiva je u repertoaru keramičkog posuđa, a pronađena

not be positively proven, its similarity to the *Szakály* site is excelling its similarity to other known sites. These similarities are evident in the way of habitation (design of housing facilities), in negligible Roman influence and in small amount of imported goods. For instance, the mortaria, exclusively Roman dishes of an utmost importance in food preparation, were to appear on both these sites only in the late Antiquity: Also, on neither of these two sites not a single lamp was found. The main difference between these two sites pertains to the ceramics: the ceramics forms at the Kiškorija site persisted from the very beginning to the very end of the settlement's life, with the minimum introduction of new forms (L7, 8), whereas at the *Szakály* site these forms were rather rare in the late Antiquity.

A number of protective researches along the by-pass, roads and highway routes in northern Croatia uncovered numerous Roman villages. Some of them show the continuity spanning from the late La Tène era to the Roman times.

Not far away from Slatina, the Slatina - Veliko Polje-Trnovača site was unveiled; a La Tène and early Roman settlement with the continuity extending up to the 2<sup>nd</sup> century has been researched. The Roman village carried on with designing the structures, organising the village and producing the dishes in the way the late La Tène population would have done (Filipović 2010: 133). The Blizna site near Jakopovec in the Varaždin area was researched and the late La Tène and early Roman settlement was unearthed. In this particular case a small Roman village persisted in continuity until the late Antiquity (Bekić 2006: 111–125, 128–132). A village dated back to the 1<sup>st</sup> century B.C. and the 1<sup>st</sup> century A.D. was discovered near Stružan (Lozok 2008: 105).

Among not so many published information on Roman villages in the Croatian territory, there is a complete publication of the excavated material from a village near Vinkovci (*Liskovac*) dated back to the 1<sup>st</sup> century. According to the material retrieved, this village also managed to preserve prehistoric traditions. This particular site is, like Kiškorija, situated near the late La Tène settlement (hill-fort), one kilometre away from each other (Ožanić Roguljić 2009: 79–80). The Virovitica Kiškorija south site is around 265 metres away from the late La Tène village of Virovitica Kiškorija north. In neither of these two examples we do not have a direct spatial continuity, but we are not to disregard the fact that both these settlements have been researched only in those parts where the communication route passes through. Therefore, we do not possess finite information regarding actual life-span of those settlements. As compared to a prehistoric village, the Virovitica Kiškorija south site is positioned 1 to 2 metres higher and a bit closer to the *Petovio-Mursa* road.

Considering the discontinuity at Kiškorija, which has been explained by its unfavourable position and retention of storm water and subterranean water, it is possible that the original settlement had been relocated to a slightly elevated location, provided that the continuity really existed. At the *Sela* site near Đakovo, a Roman village with huts made of wood and dated back in the 1<sup>st</sup> to the 4<sup>th</sup> century, has been found. The site has not been entirely published yet, but according to data available rather strong prehistoric tradition is clearly visible in the repertoire of



je i kasno latenska fibula (Haraša, Bekić 2007: 74–75). Od 2. do 4. st. datiran je lokalitet Josipovac - Verušed na kojem je pronađeno i nekoliko kasno latenskih jama (Filipec et al. 2009: 31–33). Slično kao i na Kiškoriiji, postoji vremenski diskontinuitet, s opaskom da ni ovdje lokalitet nije istražen u cijelosti pa nije za isključiti mogućnost kontinuiteta na ovom prostoru. Na prostoru Đakovštine registriran je veliki broj lokaliteta od kojih dobar dio pripada selima za koja se pretpostavlja da ih je naseljavalo domicilno stanovništvo (Knezović 2005: 86).

Sela kod kojih je zabilježen kontinuitet, prisutna su većim dijelom u regijama koje su udaljene od prometnica i centara. Ipak, to ne smijemo uzeti za pravilo budući da su istraživanja pokazala drugačije: na području između dvije važne rimske ceste u Mađarskoj pronađena su sela s minimalnim rimskim utjecajem (Gabler 1982: 92; 1990–1991: 64; 1994: 401–402; Szőnyi 1996: 255; Dizdar 2012: 131–133). Sličan primjer je i lokalitet Okuje južno od Velike Gorice. Lokalitet je smješten uz cestu Emona-Siscija, gdje je u antičkim objektima pronađena lantska keramika, a pored njih i latenske jame. Datirani bunari su iz 3. st. ali je groblje datirano od 1.–3. st.<sup>1</sup> (Bugar: u tisku; Leleković, Rendić-Miočević 2012: 291–292). To nam govori da je potrebno sagledati svako naselje i regiju zasebno, bez donošenja generalnih zaključaka. Sudbinu svakog naselja vjerojatno je odredio niz događaja i ponašanja lokalnih elita koji su uvjetovali određenu reakciju i zahtjeve Rimljana kao novih gospodara na određenom prostoru sukladno čime su Rimljani bili više ili manje tolerantni. Ukoliko je zatečeno stanovništvo predstavljalo opasnost, Rimljani bi ih preselili na drugo mjesto. Iz literature je poznat i niz slučajeva rimskih sela čiji su stanovnici potomci prapovijesnih zajednica, a koja nemaju prethodno prapovijesno selo na istom položaju već su Rimljani te stanovnike preselili i to na mjesta na otvorenom području radi lakše kontrole (Gabler 1982: 57; 1990–1991: 52; Balen et al. 2009: 36).

Posebno je potreban oprez u Podravini budući da iz tog područja nemamo jasnih spoznaja i detaljnih objava o naseljima kao što je Virovitica Kiškoriija jug, a samim time ne možemo donositi konačne zaključke, već iznijeti pretpostavke koje će se nadograđivati, opovrgnuti ili dokazati budućim istraživanjima ovog tipa naselja.

Prapovijesna tradicija očuvana je i u ciljano osnovanim selima u drugoj polovici 1. st. za vrijeme Flavijevaca koja su bila dio ekonomskog plana i procesa romanizacije. Ona se očituje u načinu života i dijelu proizvodnih aktivnosti kao i manjku uvezene robe (Brukner 1995b: 152).

Istraženi primjeri novoosnovanih sela ipak ukazuju na njihov znatno brži razvoj u odnosu na prethodni tip sela i po tome se osim vremena i razloga nastanka, međusobno razlikuju (Gabler 1982: 104).

U Turopolju je, nedaleko od rimske ceste za Sisciju, u 1. st. osnovano naselje Velika Gorica - Šepkovčica koje je

ceramic dishes and in a late La Tène fibula (Haraša, Bekić 2007: 74–75). The Josipovac - Verušed site with several late La Tène pits has been dated in the 2<sup>nd</sup> to the 4<sup>th</sup> century (Filipec et al. 2009: 31–33). Like at the Kiškoriija site, here also we can observe a temporal discontinuity. Since the results in this case are equally indefinite, one cannot rule out possible continuity. A number of sites have been registered in the Đakovo area, many of them belonging to the villages assumed to be inhabited by the local population (Knezović 2005: 86).

Villages with continuity are generally situated in the regions far away from the communication routes and regional centres. Nevertheless, this must not be seen as a rule, as the researches showed somewhat different picture: in Hungary, between the two very important Roman roads, villages with minimum Roman influence were discovered (Gabler 1982: 92; 1990–1991: 64; 1994: 401–402; Szőnyi 1996: 255; Dizdar 2012: 131–133). Similar example is the Okuje site south of Velika Gorica.

The site is located alongside the *Emona-Siscia* road and the antiquity structures next to La Tène pits contained the La Tène ceramics: the wells are dated back to the 3<sup>rd</sup> century, but the cemetery dates back from the 1<sup>st</sup> to the 3<sup>rd</sup> century<sup>1</sup> (Bugar: in print; Leleković, Rendić-Miočević 2012: 291–292). Therefore, one has to examine each settlement and each region separately, without resorting to general conclusions. The fate of each individual settlement was probably predestined by a series of events and decisions made by the local elite, thus causing certain reactions and demands imposed by the Romans, who, as new masters in the subject area, were more or less tolerant to the former. Had the indigenous population posed danger, the Romans would have them resettled to another location: The literature describes many cases of the Roman villages with the population descending from the prehistoric communities and resettled by the Romans to new villages in the open space in order to have better control over them (Gabler 1984: 57; 1990–1991: 52; Balen et al. 2009: 36).

Podravina calls for special attention, since we do not have clear knowledge and detailed data on settlements such as Virovitica Kiškoriija south so that, consequently, we are unable to reach finite conclusions. Instead, we are compelled to present assumptions that need to be upgraded, disputed or proven by conducting further researches on this type of settlements.

Prehistoric tradition has been preserved in targeted newly founded villages, which constituted a part of the economic plan and the Romanisation process in the second half of the 1<sup>st</sup> century during the Flavians. It is reflected in the way of life, as well as in a part of production activity and shortage of imported goods (Brukner 1995b: 152).

Still, the examined examples of the newly founded villages indicate their considerably higher rate of development when compared to a previous type of a village and, along with the time and reason for their appearance, this is another point of differing.

Not far away from the Roman road to *Siscia*, in Turo-

1 Zahvaljujem se kolegici A. Bugar iz Muzeja grada Zagreba na ustupljenim podacima o lokalitetu Okuje prilikom pisanja monografije kao i uvidu u arheološki materijal tijekom pisanja doktorske disertacije.

1 I wish to thank my colleague A. Bugar of the Zagreb City Museum for the data on the Okuje site from her monograph, as well as for granting me an access to archaeological material expounded in her dissertation.



trajalo do 4. st. a sastojalo se od drvenih objekata (Bugar 2009: 269–272) i čini se da se na njemu nije nalazilo pret hodno keltsko naselje. Slično tome, u Gornjem Vukojevcu otkriveno je rimsko selo datirano od 1.–3. st. gdje je keramičko posuđe pokazalo snažne prapovijesne tradicije. Vrijedni nalaz iz ovog sela su prepoznate ograđene cjeline duž ceste, s objektima različitih namjena (Dizdar et al. 2011: 63–64).

Dio rimskih sela u Panoniji nastao je u 2. st. Najbolji primjer je naselje Ivandvor kod Đakova. To je do sada najveće istraženo rimsko selo na prostoru hrvatske Panonije, datirano od kraja 2. do 4. st. Njega obilježavaju nadzemni objekti od lijepa i stupova natkriveni slamom, ali i veći objekti natkriveni tegulama i velika količina raznovrsnog arheološkog materijala. Ovo je selo u svojoj prvoj fazi funkcioniralo kao rustična vila, a život postaje intenzivniji u kasnoj antici, naročito u 4. st. (Leleković 2008: 13; Balen et al. 2009: 35–45; Leleković, Rendić-Miočević 2012: 292–293).

Virovitica Kiškorija jug pokazuje više sličnosti s naseljima koja imaju kontinuitet u odnosu na nešto mlađa, ciljana podizana naselja unatoč tome što kontinuitet na Kiškoriji nije dokazan. Ta se sličnost ogleda u tome što su način i organizacija života te arheološki materijal ostali dosljedni prapovijesnim tradicijama s minimalnim promjenama koje je donijelo ustrojstvo rimske države.

Dio nalaza s Kiškorije (ulomak snažno profilirane fibule, keramika tankih stijenki) upućuju na mogućnost ranijeg postanka. Ipak, oni su rijetki i mogli su biti u upotrebi tijekom 2. st. Pitanje je kakvi se nalazi (raniji?) kriju zapadno od istražene trase, na uzvišenom brežuljkastom terenu gdje je zabilježena još veća količina površinskih nalaza u odnosu na dionicu trase koja je istražena. Raniji postanak ili čak kontinuitet mogao bi objasniti snažno utkanu prapovijesnu tradiciju. U prilog tome govorilo bi i postojanje kasno latenskog naselja Virovitica Kiškorija sjever (Dizdar 2006a: 86–89) udaljenog samo 265 m od Kiškorije jug. Postavlja se pitanje jesu li stanovnici lokaliteta Virovitica Kiškorija sjever preci stanovnika lokaliteta Virovitica Kiškorija jug? Ukoliko jesu, ostaje nejasno gdje su živjeli tijekom 1. st. po. Kr. i kako je na sudbinu sela i stanovnika utjecao dolazak Rimljana. Samo nova istraživanja na užem prostoru Kiškorije mogu pojasniti što se događalo u tom prijelaznom i ranocarskom razdoblju. Rimsko selo, Virovitica Kiškorija jug smješteno je na uzvišenijem položaju i ono što je značajno, bliže je rimskoj cesti u odnosu na latensko naselje Virovitica Kiškorija sjever te možda u tom pravcu treba tražiti odgovor na pitanje kontinuiteta i izmiještanje stanovnika. Jačina prapovijesnih tradicija ukorijenjenih u svakodnevni život stanovnika rimskog sela idu u prilog činjenici da su stanovnici sela potomci prapovijesne zajednice s prostora Podravine. Ukoliko je ipak došlo do raseljavanja stanovnika, stanovnici Virovitice Kiškorije jug sigurno nisu došli iz daleka jer bi se na arheološkom materijalu uočili drugačiji utjecaji i tradicija s nekog drugog prostora.

Kraj života u selu bez sumnje su odredila burna doga-

polje, a settlement Velika Gorica-Šepkovčica was founded in the 1<sup>st</sup> century; the settlement consisting of structures made of wood lasted until the 4<sup>th</sup> century (Bugar 2009: 269–272) and it would appear that no Celtic settlement preceded it at that particular location. Similarly, a Roman village dated in the 1<sup>st</sup> to the 3<sup>rd</sup> century has been discovered at Gornji Vukojevac. Ceramic dishes found there indicated strong prehistoric traditions; other valuable finds included enclosed units along the road with the structures of different function (Dizdar et al. 2011: 63–64).

A part of Roman villages in Pannonia emerged in the 2<sup>nd</sup> century. The best example is a settlement called Ivandvor near Đakovo. So far it is the largest explored Roman village in the area of Croatian Pannonia, dated back to the late 2<sup>nd</sup> century to the 4<sup>th</sup> century. It is noted for its surface structures made of daub and posts covered with straw, as well as some larger structures covered with tiles and large quantity of various archaeological material. This village, in its first stage, functioned as a rustic villa, while the life in it became more intensive in the late Antiquity, especially in the 4<sup>th</sup> century (Leleković 2008: 13; Balen et al. 2009: 35–45; Leleković, Rendić-Miočević 2012: 292–293).

Virovitica Kiškorija south shares more similarities with the settlements with the continuity, rather than with somewhat younger settlements, although the continuity at Kiškorija has not been proven. These similarities reflect themselves in the way and organisation of life, which remained consistent with prehistoric traditions with minimum changes introduced by the Roman rule. The same applies to archaeological material retrieved at this particular site.

Some of the finds at the Kiškorija site (fragment of sharply profiled fibula, thin walled ceramics) indicate a possibility of an earlier period of origin. Nevertheless, they are scarce and could have been in use during the 2<sup>nd</sup> century. The question is, what (earlier?) finds could be found west of the explored route, on a yet unexplored hilly terrain where even larger quantity of surface finds have been observed. An earlier emergence, or even the continuity, could explain such a strong prehistoric tradition.

Existence of a late La Tène settlement Virovitica Kiškorija north (Dizdar 2006a: 86–89), only 265 metres away from Kiškorija south, supports the above thesis. One wonders whether the population of Virovitica Kiškorija north could have been the progenitors of the population of Virovitica Kiškorija south. If this was the case, then it remains unclear where they lived during the 1<sup>st</sup> century A.D. and what an impact the arrival of the Romans had on their lives. Only further explorations in Kiškorija could explain what was going on in this time of transition and in an early caesarean era. The Roman village of Virovitica Kiškorija south is located on a higher ground than Virovitica Kiškorija north and, more importantly, closer to a Roman road. It might be that this position is the answer to a question regarding the continuity and relocation of the population. The intensity of traditions rooted in everyday activities of the Roman village population speaks in favour of the fact that the inhabitants of that particular village were descendants of the prehistoric community living in the Podravina area.

If the relocation of population did take place, the inhabitants of Virovitice Kiškorije south would not have come from afar. Had they come from afar, then the archaeolo-



đanja u vremenu seobe naroda. Život u otvorenim nizin-  
skim naseljima seoskog tipa sigurno je postao vrlo težak i  
neizvjestan, pa se stanovništvo sklanjalo na sigurnija mje-  
sta ili udaljene, sigurnije krajeve. U najmlađem datiranom  
objektu iz 5. st. nema nikakvih novih, u ranijim razdoblji-  
ma pronađenih elemenata. To sugerira da su se stanovnici  
ovog lokaliteta iselili i da u njega nisu pridošli novi stanov-  
nici. S obzirom na povijesna zbivanja, za očekivati je da je  
situacija ista i na neistraženom dijelu lokaliteta.

Istraživanje i spoznaje do kojih se došlo analizom i obja-  
vom ovog lokaliteta od velike je važnosti za arheologiju  
Podravine i hrvatskog dijela Gornje Panonije. On se nalazi  
na prostoru s kojeg nemamo dovoljno informacija o životu  
u antici, a općenito govoreći u Hrvatskoj nemamo dovolj-  
no informacija o načinu života u rimskim selima.

Pored upoznavanja aspekta ruralnog načina života, na-  
glasak svakako treba staviti na bolje poznavanje uporabne  
keramike lokalne proizvodnje i njezine tradicije, do kojeg  
je došlo obradom posuđa pronađenog na Kiškorijski. Tako-  
đer, njenom usporedbom s posuđem okolnog područja,  
otkriveno je postojanje više mikroregija, sa samo za njih  
prepoznatljivim obilježjima keramičkog posuđa. Ta se obi-  
lježja, razvidna iz oblikovanja, ukrašavanja i izrade posuđa  
nadovezuju na mikroregije i prapovijesne zajednice koje  
su nastavale ispitano područje prije dolaska Rimljana te  
čine logičan i očekivani slijed.

Broj istraženih i objavljenih rimskih sela u južnoj Pano-  
niji još uvijek je premali da bi se moglo govoriti o modeli-  
ma rimskih sela s odgovarajućim primjerima: kasno laten-  
ska sela koja preživljavaju dolazak Rimljana, ciljano novoo-  
snovana sela, sela koja su kasnijeg postanka ili sela koja se  
razvijaju iz rustičnih vila tijekom kasne antike. Slaba istra-  
ženost antike u Podravini ne dozvoljava konačne zaključke  
koji bi se odnosili na modele nastajanja sela u ranocarskom  
i srednjecarskom razdoblju, a vjerujem kako je tu ključnu  
ulogu imala politika i odnosi na lokalnoj razini između pra-  
povijesnih zajednica ovog prostora i rimskih osvajača.

Istraživanje lokaliteta Virovitica Kiškorijski jug od izuzet-  
nog je značaja jer nam je donijelo informacije o ruralnom  
načinu života u Gornjoj Panoniji. Vjerujem da će naredne  
godine donijeti mnoge objave kolega koji su uspješno  
vodili velika zaštitna istraživanja, na kojima su pronađena  
rimska sela i da ćemo na taj način dobiti mnogo odgovora,  
ali i pobuditi znatiželju za novim istraživanjima i spozna-  
jama o ruralnom aspektu rimskog načina života u južnoj  
Panoniji.

gical material would certainly exhibit different influences  
and tradition of some other area.

Termination of life in the village came as a result of tur-  
bulent events at the times of massive relocation of entire  
nations. Life in lowlands, in open-space settlements of ru-  
ral type must have been difficult and uncertain, driving the  
inhabitants to look for safer and far-away places to live in.  
The youngest structure, dated back to the 5<sup>th</sup> century, did  
not contain any new elements found in the earlier periods.  
This would suggest that the inhabitants of this settlement  
moved out and no-one came to replace them. Considering  
the historical developments, one would expect to find the  
same on the rest of the site that has not been explored as  
yet.

Exploration and knowledge acquired through the  
analysis and disclosure of this site are of an utmost impor-  
tance to the archaeology of Podravina and the Croatian  
part of Upper Pannonia. The site is located in the area that  
has not provided ample information on life in the Antiqui-  
ty, and speaking in general, we do not have enough infor-  
mation on the way of life in Roman villages in Croatia.

Besides acquiring knowledge of the aspects of the ru-  
ral way of life, an emphasis ought to be placed on better  
knowledge about the locally produced functional cera-  
mics and its tradition that resulted through the processing  
of the dishes found at Kiškorijski. In addition, the compari-  
son of this ceramics and the dishes from the neighbouring  
areas revealed the existence of several micro-regions and  
the ceramic dishes featuring distinguishable attributes  
typical for these particular micro-regions. These attrib-  
utes – manifested in design, decoration and craftsmanship  
of the dishes – are the extension of a micro-region and a  
prehistoric community living in the explored area prior to  
the arrival of the Romans, thus constituting a logical and  
anticipated sequel.

Total number of explored and published Roman villa-  
ges in southern Pannonia is still inadequate for discussing  
the models of Roman villages with relevant examples: late  
La Tène villages that managed to survive arrival of Romans;  
targeted, newly-founded villages; villages that emerged at  
a later date; or villages developed from rustic villas in the  
late Antiquity. Inadequately researched Antiquity in Podra-  
vina would not allow us to make any final conclusions as to  
the models of village formation in an early caesarean and  
mid-caesarean era, and it is my belief that the politics and  
relationships between prehistoric communities and Ro-  
man conquerors played the key role in this particular area.

Exploration of the Virovitica Kiškorijski south site is of a  
paramount significance, since it yielded the information  
on rural way of life in Upper Pannonia. I believe that in the  
years to come a number of publications will be made by  
our colleagues who successfully conducted huge protec-  
tive researches, which in turn resulted in discovery of Ro-  
man villages, and that many questions will be answered  
just as the interest in new researches and new knowledge  
about the rural aspect of the Roman way of life in southern  
Pannonia will be aroused.

V DIO



PART V





8.

**Popis literature i izvora**

*Literature and sources*



- Alcock, J. P. 2006, *Food in ancient World*, Greenwood Press, Westport, Connecticut, London.
- Almgren, O. 1923, *Studien über Nordeuropäische Fibelformen der ersten nachchristlichen Jahrhunderte mit Berücksichtigung der provinziäl-römischen und südrussischen Formen*, Leipzig.
- Antonelli, F., Lazzarini, L. 2010, Mediterranean trade of the most widespread Roman volcanic millstones from Italy and petrochemical markers of their raw materials, *Journal of Archaeological Science*, 37, 2081–2092.
- Applebaum, S. 1958, Agriculture in Roman Britain, *Agricultural History Review*, 6.2, 66–86.
- Arthur, P. 2007, Pots and boundaries. On cultural and economic areas between late antiquity and the early middle ages, in: *Late Roman Coarse Ware*, 2, Oxford, 15–28.
- Baćani, I., Škrkulja, R., Tomaš Barišić, T. 2011. *Zaštitna arheološka istraživanja Gradskog muzeja Sisak 2000-2010.*, Sisak.
- Balen, J., Bilić, T., Bunčić, M., Drnić, I., Solter, A. 2009, Rezultati zaštitnih istraživanja na lokalitetu Ivandvor - šuma Gaj, *Vjesnik arheološkog muzeja u Zagrebu*, 3.s., XLII, 23–72.
- Barkóczi, L. 1988, Pannonische Glasfunde in Ungarn, *Studia Archaeologica*, 9, Budapest.
- Baatz, D. 1976–1977, Reibschale und Romanisierung, *Rei Cretariae Romanae Favtorvm*, Acta XVI–XVIII, Augst, 147–158.
- Bavdek, A. 2005, Rimsko žarno grobišće Volarije pri Žirjah na Krasu, *Arheološki vestnik*, 56, 235–262.
- Bédoyère, de la, G. 2000, *Pottery in Roman Britain*, Shire.
- Bekić, L. 2006, *Zaštitna arheologija u okolici Varaždina*, Zagreb.
- Bekić, L. (ed.) 2007, *Zaštitna arheologija na magistralnom plinovodu Pula – Karlovac*, Zagreb.
- Belmont, A. 2011, Why dig a millstone quarry? The case of Claix in the south-west of France (5<sup>th</sup>–19<sup>th</sup> centuries), in: *Bread for the People: The Archaeology of Mills and Milling, Proceedings of a colloquium held in the British School at Rome 4<sup>th</sup>–7<sup>th</sup> November 2009*, Williams D., Peacock D. (eds.), BAR International Series 2274, Oxford, 1–17.
- Bertol, A. 2011, Nalazi rimskog novca s lokaliteta Virovitica-Kiškorija jug i Orešac / Roman coins from the Virovitica - Kiškorija south and Orešac sites, *Opvsclva archaeologica*, Vol. 35, 225–261.
- Bilkei, I., Solti, J. 1976, Hauskeramik, *Acta Archaeologica Academiae Scientiarum Hungaricae*, XXVIII, 1–2, 176–192.
- Bíró, Sz. 2004, Savaria nyugati temetője (Das westliche gräberfeld von Savaria), *Savaria*, 28, 63–134.
- Bíró, S. K., Gabler, D., Gáspár, D., Kelemen, H. M., Palágyi, K. S., Maróti, É., Regénye, J., Ritoók, Á., Szabó, K., Vörös, I. 1992, A balácai vil-lagazdaság főépületének pincéje (Keller des Hauptgebäudes des Balácaer Gutshofes), *Balácai közlemények* II, 7–218.
- Bjelajac, L. 1995, Late Roman Glazed Pottery in Singidunum (Moesia I), Alba Regia XXV, *Rei Cretariae Romanae Favtorum*, Acta, XXXIV, Székesfehérvár, 33–37.
- Bobovec, A. 2003, Arheološka topografija područja općina Popovača i Velika Ludina, *Zbornik Moslavine*, V/VI, 13–24.
- Bobovec, A. 2007, Kutinska Lipa, Kutina – arheološko nalazište iz rimskog razdoblja (II.–IV. st. n. e.), *Zbornik Moslavine*, IX/X, 151–164.
- Bobovec, A. 2008, *Rimski kompleks Ciglenice u Osekovu*, Kutina.
- Bojović, D. 1977, *Rimska keramika Singidunuma*, Beograd.
- Bojović, D. 1983, *Rimske fibule Singidunuma*, Beograd.
- Bökönyi, S. 1974, *History of Domestic Mammals in Central and Eastern Europe*, Akadémiai Kiadó, Budapest.
- Bónis, É. von B. 1942, *Die Kaiserzeitliche Keramik von Pannonien*, Dissertationes Pannonicae, ser. II. No. 20.
- Bónis, É. von B. 1980, Pottery, in: *The archaeology of Roman Pannonia*, Lengyel A., Radan G. T. B. (eds.), Budapest, 357–380.
- Bónis, É. von B. 1991, Glasierte Keramik aus Tokod, *Acta Archaeologica Academiae Scientiarum Hungaricae*, XLIII, 1–2, 88–150.
- Bónis, É. von B. 1993.–1994, Császárkori telep Balatonaligán, *A Veszprém megyei múzeumok közleményei*, 19–20, 157–176.
- Borić Brešković, B. 1976, *Novac kolonije Viminacijuma*, Beograd.
- Brajković, D., Paunović, M. 2001, La faune des vertébrés du site archéologique de Loron, in: *Loron (Croatie) – Un grand centre de production d'amphores à huile istriennes (I<sup>er</sup>–IV<sup>e</sup> S. P. C.)*, Tassaux F., Matijašić R., Kovačić V. (eds.), Bordeaux, 279–291.
- Broudy, E. 1993, The Book of Looms: A History of the Handloom from Ancient Times to the Present, Hanover. [http://books.google.hr/books?id=shN5\\_W1RzcC&printsec=frontcover&hl=hr#v=onepage&q&f=false](http://books.google.hr/books?id=shN5_W1RzcC&printsec=frontcover&hl=hr#v=onepage&q&f=false)
- Bruck, G. 1961, *Die spätrömische kupferprägung*, Graz.
- Brukner, O. 1971, Osnovne forme i tehnike rimsko – provincijske keramike u Sirmiju, *Materijali*, VIII, Zenica, 31–46.
- Brukner, O. 1981, *Rimska keramika u jugoslovenskom delu provincije Donje Panonije*, Beograd.
- Brukner, O. 1992, Keramička proizvodnja in: *Gomolava – rimski period*, Novi Sad, 11–59.
- Brukner, O. 1995a, Domorodačka naselja in: *Arheološka istraživanja duž auto puta kroz Srem*, Novi Sad, 91–136.
- Brukner, O. 1995b, Rimska naselja i vile rustike in: *Arheološka istraživanja duž auto puta kroz Srem*, Novi Sad, 137–174.
- Bugar, A. 2000, *Ranija rimska keramika s lokaliteta Sv. Križ – Sisak*, Diplomski rad, Sveučilište u Zagrebu, Zagreb.
- Bugar, A. 2009, Lokalitet: Šepkovčica, *Hrvatski arheološki godišnjak*, 5/2008, 269–273.
- Bugar, A. Lokalitet: Okuje, Arheometrijske analize i njihova primjena u arheološkoj interpretaciji na primjeru lokaliteta Okuje, *Hrvatski arheološki godišnjak* 8/2011, in press.
- Bugar, A., Mašić, B. 2013, *MGZ u službi arheologije*, Zagreb.
- Bulat, M. 2002, Tragovi antičkog vinogradarstva i vinarstva u Slavoniji, *Osječki zbornik*, 26, 45–52.
- Buljević, Z. 1999, Kasnoantičke narukvice od stakla i gagata u zbirci arheološkog muzeja u Splitu, *Vjesnik za arheologiju i historiju Dalmatinsku*, 92, 18–205.
- Caneva, G., Kumanic, A. 2009, Plants in ancient artistic representations as a tool of communication and a cultural message, *Proceedings, 4th International Congress on "Science and Technology for the Safeguard of Cultural Heritage in the Mediterranean Basin"* Vol. II, Kairo, 255–259.

- Cappers, R. T. J., Bekker, R. M., Jans, J. E. A. 2006, *Digitale Zadenatlas van Nederland (Digital seed atlas of the Netherlands)*, Barkhuys publishing & Groningen University library Groningen.
- Cermanović-Kuzmanović, A. 2004, *Tekija*, Beograd.
- Cool, H. E. M. 1995, Glass vessel of the fourth and early fifth century in Roman Britain, in: *Le verre de l'Antiquité Tardive et du haut Moyen Âge, Typologie-chronologie-diffusion (Guiry-en-Vexin 1993), Actes du 8<sup>e</sup> colloque de l'AFAV Guiry-en-Vexin, Musée départemental du Val-d'Oise*, 187–244.
- Cool, H. E. M. 2006, *Eating and drinking in Roman Britain*, Cambridge.
- Crowfoot, G. M. 1936–1937, Of the Warp-weighted loom, *The Annual of the British School at Athens*, Vol. 37, 36–47.
- Cserményi, V. 1977, Hauskeramik, *Acta Archaeologica Academiae Scientiarum Hungaricae*, XXIX, 1–2, 245–269.
- Csirke, O. 2004, Késő római sírok Balácán – Spätromische Gräber in Baláca, *Balácai közlemények*, VIII, 237–256.
- Cuomo di Caprio, N. 1982, *Ceramica rustica tradizionale in Puglia*, Congedo ed.
- Curle, J. 1911, *A Roman Post and its People, The Fort of Newstead In the Parish of Melrose*, Glasgow.
- Cvjetičanin, T. 1995, Late Roman Glazed Pottery from the Iron Gate Region (*Dacia Ripenses*), *Alba Regia*, XXV, *Rei Cretariae Romanae Favtorvm*, Acta, XXXIV, Székesfehérvár, 27–32.
- Cvjetičanin, T. 1996, Some Observations about Pottery Evidence from Diana, in: *Roman Limes on the Middle and Lower Danube*, Beograd, 93–99.
- Cvjetičanin, T. 2003, Basic Attributes of the Late Roman Glazed Pottery from Central and Southern Serbia in: *Die Archäologie und Geschichte der Region des Eisernen Tores Zwischen 275–602 N. Chr.*, Bukurest, 93–108.
- Cvjetičanin, T. 2006, *Late Roman Glazed Pottery, Glazed Pottery from Mesia Prima, Dacia Ripensis, Dacia Mediterranea and Dardania*, Beograd.
- Czysz, W., Hartmann, H. H., Kaiser, H., Mackensen, M., Ulbert, G. 1981, *Römische Keramik aus Bad Wimpfen*, Stuttgart.
- Čargo, B. 2002, *Ključevi i lokot*, in: *Longae Saloniae*, Marin E. (ed.), Arheološki muzej, Split, 549–559.
- Dalby, A. 2003, *Food in ancient world from A-Z*, London.
- Dautova-Ruševljan, V. 2003, *Kasnoantička nekropola kod Sviloša u Sremu*, Novi Sad.
- Dautova-Ruševljan, V., Brukner, O. 1992, *Gomolava, Rimski period*, Novi Sad.
- Della Porta, C., Sfredda, N. 1996, La ceramica comune in: *Bedriacum 1.2*, Milano, 133–186.
- Demo, Ž. 1981 Skupni nalaz novca i nakita 3. stoljeća iz Bušetine kraj Virovitice, *Podravski zbornik*, 7, 214–227.
- Demo, Ž. 1982, Rezultati arheoloških iskopavanja ranocarske nekropole u Kunovec Bregu kraj Koprivnice, *Podravski zbornik*, 8, 279–327.
- Desbat, A. 2013, Les foyers culinaires du "sanctuaire de Cybèle" et la question des cuisines à Lugdunum, in: *Cuisines et boulangeries en Gaule Romaine*, Mauné S., Monteix N., Poux M. (eds.), Paris, 27–38.
- De Vos, M., Attoui, R., Andreoli, M. 2011, Hand and "donkey" mills in North African farms, in: *Bread for the People: The Archaeology of Mills and Milling, Proceedings of a colloquium held in the British School at Rome 4<sup>th</sup>–7<sup>th</sup> November 2009*, Williams D., Peacock D. (eds.), BAR International Series 2274, Oxford, 131–150.
- Diedonné-Glad, N. 1999, Métallurgie du fer et habitat rural, in: *Monographies instrumentum*, 9, *Artisanat et productions artisanales en milieu rural dans les provinces du nord-ouest de l'empire romain*, Actes du colloque d'Erpeldange, mars 1999, Montagnac, 39–44.
- Dizdar, M. 2006a, Lokalitet: Virovitica - Kiškorijska sjever, *Hrvatski arheološki godišnjak*, 2/2005, 86–89.
- Dizdar, M. 2006b, Zaštitna istraživanja naselja latenske kulture na nalazištu Virovitica - Kiškorijska sjever, *Annales Instituti Archaeologici*, II, 55–60.
- Dizdar, M. 2007, Naselje mlađeg željeznog doba, Virovitica - Kiškorijska sjever, in: *Zapadna virovitička obilaznica, Zaštitna arheološka istraživanja 2005./2006. godine*, Sabolić D. (ed.), Virovitica, 35–46.
- Dizdar, M. 2012, The Archaeological Background to the Formation of Ethnic Identities, in: *The Archaeology of Roman Southern Pannonia, The state of research and selected problems in the Croatian part of the Roman province of Pannonia*, Migotti B. (ed.), BAR International Series 2393, 117–136.
- Dizdar, M., Tonc, A., Dizdar Ložnjak, D. 2011, Zaštitna istraživanja nalazišta AN 6 Gornji Vukojevac na trasi auto-ceste Zagreb – Sisak, dionica Velika Gorica jug – Lekenik, *Annales Instituti archaeologici*, VIII, 61–64.
- Dolenz, H. 1998, *Eisenfunde aus der Stadt auf dem Magdalensberg*, Klagenfurt.
- Dombay, J. 1957, Későrómai temetők Baranyában (Spätromische Friedhöfe im komitat Baranya), *A Janos Pannonius Múzeum Évkönyve*, 181–330.
- Domić Kunić, A. 2003, *Plinijeva geografija i etnografija Ilirika (s osobitim obzirom na panonski dio iliričkog prostora)*, Doktorska disertacija, Sveučilište u Zagrebu, Zagreb.
- Drenje, 1987, Rezultati istraživanja 1980–1985, Brdovec.
- Džino, D. 2005, Sabaiarius: Beer, Wine and Ammianus Marcellinus. Feast, Fast or Famine: Food and Drink in Byzantium, *Byzantina Australiensia*, 15, 57–68.
- Eggers, H. E. 1951, *Der römische Import im freien Germanien*, Hamburg.
- Eke, I., Horváth, L. 2006, Late Roman cemeteries at Nagykanizsa, in: *Archaeological Investigations in Hungary 2005*, Budapest, 73–86.
- Ercegović-Pavlović, S. 1980, Les nécropoles romaines et médiévales de Mačvanska Mitrovica, *Sirmium XII*.
- Farmer, V. 1918, *Roman Farm Management, The treaties of Cato and Varro done into English, with Notes of Modern Instances*, New York.
- Fazekas, F. 2007, *Die römische Siedlung bei Babarc, Komitat Baranya/Un-garn*, Passau.
- Fiedler, M., Schultze, E. 2005, Ausgrabungen einer kaiserzeitlichen jungbronzezeitlichen Siedlung bei Schwennenz, Lkr. Uecker-Randow (Vorpommern) – Neues zur Getreide-Vorratshaltung bei den Germanen, *Bericht der Römisch-Germanischen Kommission*, Band 85 (2004).
- Filipec, K., Šiša Vivek, M., Roksandić, D. 2009, Lokalitet: Josipovac - Verušed, *Hrvatski arheološki godišnjak*, 5/2008, 30–33.
- Filipović, S. 2010, Lokalitet: Slatina - Veliko polje - Trnovača, *Hrvatski arheološki godišnjak*, 6/2009, 132–135.

- Fisković, I. 2001, Prilozi arheološkoj topografiji Pelješkog kanala, *Izdanja Hrvatskog arheološkog društva*, 20, Zagreb, 51–74.
- Flint-Hamilton, K. B. 1999, Legumes in Ancient Greece and Rome, *Hesperia*, 68, 371–385.
- Foy, D. 1995, Le verre de la fin du IV<sup>e</sup> au VIII<sup>e</sup> siècle en France méditerranéenne, premier essai de typochronologie in: *Le verre de l'Antiquité Tardive et du haut Moyen Âge, Typologie-chronologie-diffusion (Guiry-en-Vexin 1993), Actes du 8e colloque de l'AFAV Guiry-en-Vexin, Musée départemental du Val-d'Oise*, 11–23.
- Fülep, F. 1984, *Sopiana, The History of Pécz during the Roman era, and the Problem of the Continuity of the Late Roman Population*, Budapest.
- Gabler, D. 1973, Der Römische Gutshof von Fertőrákos - Golgota, *Acta Archaeologica Academiae Scientiarum Hungaricae*, XXV, 1–2, 139–176.
- Gabler, D. 1982, Aspects of the development of Late Iron Age settlements in Transdanubia into the Roman period (evidence based upon the excavations at Szakály in Southern Hungary) in: *Studies in the Iron Age of Hungary*, BAR International series, 144, 57–128.
- Gabler, D. 1990–1991, The shaping of the life of the late La Tène Settlements in the Roman period, *Antaeus*, 19–20, 51–72.
- Gabler, D. 1994, Die Ländliche Besiedlung Oberpannoniens, in: *Ländliche Besiedlung und Landwirtschaft in den Rhein-Donau-Provinzen des Römischen Reiches, Vorträge eines Internationalen Kolloquiums vom 16.-21. April 1991 in Passau*, Espelkamp, 377–420.
- Gabler, D., Ottományi, K. 1990, Késő római házak Szakályban (Late roman houses in Szakály), *Archaeologiai Értesítő*, 117/2, 161–188.
- Galić, M., Radman-Livaja, I. 2002, Zaštitno istraživanje u Samoborskim Novakima 2000, godine, *Vjesnik Arheološkog muzeja u Zagrebu*, 3. ser. XXXV, 239–248.
- Garnsey, P., Saller, R. 1987, *The Roman Empire. Economy, Society and Culture*, Berkley and Los Angeles.
- Gäzdac, C., Alföldy-Gäzdac, A. 2008, The management of a monetary crisis? The "P M COL VIM" and "Provincia Dacia" coinages in the Roman monetary policy of the 3rd century AD, *Numismatische Zeitschrift*, Bd 116/117, 135–173.
- Giesler, U. 1981, Die Kleinfunde in: *Ad Pirrvm (Hrušica), Spätromische Passbefestigung in den Julischen Alpen*, Ulbert T. (ed.), Münchener Beiträe zur Vor- und Frühgeschichte, 31, 163–246.
- Gluhak, T. M., Hofmeister, W. 2009, Roman lava quarries in the Eifel region (Germany): geochemical data for millstone provenance studies, *Journal of Archaeological Science*, 36, 1774–1782.
- Glušćević, S., Jurišić, M., Šošćarić, R., Vujčić Karlo, S. 2006, Evidence for the nutrition of sailors from the Roman harbour at Zaton near Zadar, *Archaeologia Maritima Mediterranea*, 3, 147–161.
- Gorenc, M., Nemeth-Ehrlich, D. 1985, *Pyrrhi* – Komin, antička nekropola, *Arheološki pregled*, 24, 103–104.
- Grant, A. 1982, The use of tooth wear as a guide to the age of domestic ungulates, in: *Ageing and Sexing Animal Bones from Archaeological Sites*, Wilson B., Grigson, C., Payne, S. (eds.), BAR, British Series 109, Archaeopress, Oxford, 91–108.
- Gregl, Z. 1989, *Rimskodobna nekropola Zagreb – Stenjevec*, Zagreb.
- Gregl, Z. 1997, *Rimske nekropole sjeverne Hrvatske*, Arheološki muzej Zagreb, Zagreb.
- Gregl, Z. 2002, Antika in: *Žumberak od prapovijesti do kasne antike*, Zagreb, 82–91.
- Gregl, Z. 2003, Gornja Vas na Žumberku. Grob 36, *Opisno arheološka, Vol. 27*, 469–479.
- Gregl, Z. 2007, Rimskodobna nekropola Gornja Vas na Žumberku, *Vjesnik Arheološkog muzeja u Zagrebu*, 3. ser. XL, 221–331.
- Gregl, Z., Lazar, I. 2008, *Bakar Staklo iz rimske nekropole Bakar/The Glass from the Roman Cemetery*, Katalozi i monografije Arheološkog muzeja u Zagrebu, Vol. V, Zagreb.
- Gregl, Z., Jelinčić, K. 2010, O nekim manje poznatim antickim lokalitetima u Zagrebu i okolici, *Vjesnik Arheološkog muzeja u Zagrebu*, 3. ser. XLIII, 153–191.
- Grgurić, M. 2011, Fauna ranosrednjovjekovnog lokaliteta Buzin, *Vjesnik Arheološkog muzeja u Zagrebu*, 3. ser. XLIV, 329–337.
- Groot, M. 2008, *Animals in ritual and economy in a Roman frontier community: Excavations in Tiel-Passewaaij*. Amsterdam University Press, Amsterdam.
- Gudea, N. 1996, *Porolissum*, Cluj – Napoca.
- Gugo Rumštajn, K., Štilinović, A., Trbojević Vukičević, T. 2009, Srednjovjekovni kompleks na položaju Podgrađe u Kninu - rezultati arheozoološke analize koštanog materijala, in: *Jurišićev zbornik. Zbornik radova u znak sjećanja na Mariju Jurišića*, Bekić L. (ed.), Zagreb, 206–212.
- Guiraud, H. 1989, Bagues et anneaux à l'époque romaine en Gaule, *Gallia*, 46, 173–211.
- Gyulai, F. 2010, *Archaeobotany in Hungary: Seed, Fruit and Beverage Remains in the Carpathian Basin from the Neolithic to the Late Middle Ages*, *Archaeolingua*, 21, Budapest.
- Hanuliak, M. 1989, Praveké, včasnodedjinné, a stredoveké osídlenie v chl'abe, *Slovenska archeológia*, XXXVII-1, 151–212.
- Haraša, I., Bekić, L. 2007, Lokalitet: Sela, *Hrvatski arheološki godišnjak*, 3/2006, 74–75.
- Hargis, M. B. 2007, *A mortarium at Cetamura del Chianti in context*, Master Thesis, The Florida State University.
- Hilgers, W. 1969, *Lateinische Gefässnamen*, Düsseldorf.
- Hillson, S. 1986, *Teeth*, Cambridge University Press, Cambridge.
- Hillson, S. 1992, *Mammal Bones and Teeth: An Introductory Guide to Methods of Identification*, Institute of Archaeology, University College London, London.
- Horvat, J. 1990, *Nauportus (Vrhnik)*, Ljubljana.
- Horvat, J. 1997, *Sermin*, Opera Instituti archaeologici, 3, Znanstveno raziskovalni center SAZU, Ljubljana.
- Horvat et al., 2003, *Poetovio*, development and topography, in: *The Autonomous Towns of Noricum and Pannonia, Pannonia I, Situla* 41, 153–189.
- Humphrey, J. W., Oleson, J. P., Sherwood A.N. 1999, *Greek, and Roman Technology. A Sourcebook. Annotated translations of Greek and Latin texts and documents*, London/New York.
- Istenič, J. 1999, *Poetovio, zahodna grobišča I*, Grobne celote iz Deželnega muzeja Joanneuma v Gradcu, Ljubljana.
- Istenič, J. 2000, *Poetovio, zahodna grobišča II*, Grobne celote iz Deželnega muzeja Joanneuma v Gradcu, Ljubljana.
- Istenič, J., Schenider, G. 2000, Aegean cooking ware in the eastern Adriatic, *Acta Archaeologica Academiae Scientiarum Hungaricae*, XXXVI, 341–348.

- Ivanišević, V., Nikolić-Dorđević, S. 1997, Novi tragovi antičkih fortifikacija u Singidunumu, *Singidunum I*, 71–146.
- Jacomet, S. 2010, *Practical course: Identification of Archaeological Plant Macrofossils (seeds and fruits) MSc "Prehistory and Archaeological Science"*, IPNA, Universität Basel.
- Jelinčić, K. 2003, Rimska keramika iz Iloka, *Prilozi Instituta za arheologiju*, Vol. 20, 79–88.
- Jelinčić, K. 2006a, Lokalitet: Virovitica - Kiškorija jug, *Hrvatski arheološki godišnjak*, 2/2005, 83–86.
- Jelinčić, K. 2006b, Zaštitno arheološko iskopavanje lokaliteta Virovitica - Kiškorija jug, *Annales Instituti Archaeologici*, II, 61–66.
- Jelinčić, K. 2007a, Virovitica - Kiškorija jug, in: *Zapadna virovitička obilaznica, Zaštitna arheološka istraživanja 2005./2006. godine*, Sabolić D. (ed.), Virovitica, 29–34.
- Jelinčić, K., 2007b, Kasnoantičke narukvice od staklene paste s lokaliteta Virovitica - Kiškorija jug, *Prilozi Instituta za arheologiju*, Vol. 24, 213–220.
- Jelinčić, K. 2009, *Rimska keramika lokalne proizvodnje na području hrvatskog dijela rimske provincije Gornje Panonije*, Doktorska disertacija, Sveučilište u Zagrebu, Zagreb.
- Jeschek, G. 2000, *Die grautonige Keramik aus dem römischen Vicus von Gleisdorf*, Wien.
- Jurišić, M. 2000, *Ancient Shipwrecks of the Adriatic, Maritime transport during the first and second centuries AD*, BAR International Series 828, Oxford.
- Katavić, V. 2001, *Pregled rimskog materijala izvan jugozapadnog dijela bedema antičke Siscije*, Diplomski rad, Sveučilište u Zagrebu, Zagreb.
- Kapitän, G. 1980, Three terracotta braziers from the sea off Sicily, *The International Journal of Nautical Archaeology and Underwater Exploration* 9.2, 127–131.
- Kessler, D., Temin, P. 2007, The Organization of the Grain Trade in the Early Roman Empire, *The Economic History Review*, New Series, Vol. 60, no. 2, 313–332.
- Killgrove, K. 2010, *Migration and Mobility in Imperial Rome*, Chapel Hill, (doktorska disertacija).
- Knez, T. 1992, *Novo Mesto II, keltsko - rimsko grobišće Beletov vrt*, Novo Mesto.
- Knezović, I. 2005, Prilog antičkoj arheološkoj topografiji Đakovštine, *Zbornik Muzeja Đakovštine*, 7, 61–90.
- Knific, T. 1979, Vranje pri Sevnici, *Arheološki vestnik*, 30, 732–763.
- Kohler-Schneider, M. 2001a, Verkohlte Kultur- und Wildpflanzenreste aus Stillfried an der March als Spiegel spätbronzezeitlicher Landwirtschaft im Weinviertel, Niederösterreich, *Mitteilungen der Prähistorischen Kommission*, 37, Verlag der Österreichischen Akademie der Wissenschaften, Wien.
- Kohler-Schneider, M. 2001b, Prähistorische Getreidefunde, eine Bestimmungshilfe für verkohlte Korn- und Druschreste, *Scriptum zu den UE "Archäobotanische Arbeitsmethoden" Institut für Botanik*, BOKU, Wien.
- Kooistra, L. M. 1996, *Borderland farming Possibilities and limitations of farming in the Roman period and early Middle Ages between the Rhine and Meuse*, Van Gorcum, Assen.
- Kordić, A. 2001, *Keramika 3. i 4. stoljeća s lokaliteta Sv. Križ – Sisak*, Diplomski rad, Sveučilište u Zagrebu.
- Kos, P. 1986, *The monetary circulation in the southeastern Alpine region ca. 300 BC – AD 1000*, Situla, Vol. 24.
- Kos, P. 1992, The Provincia Moesia Superior in Vimincium, *Zeitschrift für Papyrologie und Epigraphik*, 91, 212–214.
- Kos, P. 1998, *Leksikon antičke numizmatike*, Zagreb.
- Kocztur, É. 1974, Ausgrabungen im südlichen Stadtviertel von Gorsium (Tác – Marggitelep), *Alba Regia*, XIII, 1972, 69–148.
- Koščević, R. 1980, *Antičke fibule s područja Siska*, Zagreb.
- Koščević, R. 1996, Nekoliko primjeraka staklene bižuterije iz rimskog razdoblja, *Prilozi Instituta za arheologiju*, Vol. 10, 81–92.
- Koščević, R. 2013, *Siscia, Pannonia Superior, Old and new finds*, BAR International Series 2461.
- Koščević, R., Makjanić, R. 1986, Neki noviji arheološki rezultati s područja antičke Siscije, *Izdanja Hrvatskog arheološkog društva*, 10, Zagreb, 119–135.
- Koščević, R., Makjanić, R. 1986–1987, Antički tumuli kod Velike Gorice i nova opažanja o Panonskoj radionici glazirane keramike, *Prilozi Instituta za arheologiju*, Vol. 3–4, 25–70.
- König, M. 1993, Über die Bedeutung des Holunders (*Sambucus spec.*) in vorgeschichtlicher und jüngerer Zeit, *Funde und Ausgrabung im Bezirk Trier*, Bd. 25, 3–9.
- Kovrig, I. 1937, *Die Haupttypen der Kaiserzeitlichen Fibeln in Pannonien*, Dissertationes Pannonicae II, 4.
- Krekovič, E. 1998, *Römische Keramik aus Gerulata*, Bratislava.
- Kroll, H. 1991, Südosteuropa (Southeast Europe), in: *Progress in Old World Palaeoethnobotany* Zeist W. van, Wasylkova K., Behre K.-E. (eds.), Balkema, Rotterdam, 161–177.
- Kron, G. 2002, Archaeozoological Evidence for the Productivity of Roman Livestock Farming. *Münstersche Beiträge zur Antiken Handelsgeschichte*, Bd. XXI, H. 2, 53–73.
- Kukuljević-Sakcinski, I. 1873, Panonija Rimska, Rad JAZU XXIII, Zagreb, 86–157.
- Kujundžić, Z. 1982, *Poetovijske nekropole*, Katalogi in monografije 20, Narodni muzej v Ljubljani, Ljubljana.
- Küster, H. 1991, Mitteleuropa südlich der Donau, einschliesSlikaich Alpenraum (Central Europe south of the Danube), in: *Progress in Old World Palaeoethnobotany* Zeist W. van, Wasylkova K., Behre K.-E. (eds.), Balkema, Rotterdam, 179–187.
- Kužir, S., Trbojević Vukičević, T. 2004, Životinjski nalazi s arheološkog lokaliteta Torčec - Gradić, *Podravina* 3 (6), 116–121.
- Lauwerier, R. C. G. M. 2004, The economic and non-economic animal: Roman depositions and offerings. in: *Behaviour Behind Bones*, Proceedings of the 9<sup>th</sup> ICAZ Conference, O'Day, S. J., Van Neer, W., Ervynck A. (eds.), Durham 2002, Oxbow Books, Oxford, 66–72.
- Lazar, I. 2003, *Rimsko steklo Slovenije / The Roman glass of Slovenia*, Opera Instituti archaeologici Sloveniae, 7, Ljubljana.
- Lazar, I. 2004, *Rimljani, Steklo, glina, kamen*, Celje – Maribor – Ptuj.
- Lazar, I. 2006, *Ilovica pri Vranskem, Arheologija na avtocestah Slovenije*, Katalogi, 1, Ljubljana.
- Leleković, T. 2008, Ilandvor, *Hrvatski arheološki godišnjak*, 4/2007, 2–15.
- Leleković, T., Rendić-Miočević, A. 2012, Rural Settlements, in: *The Ar-*

chaeology of Roman Southern Pannonia. The state of research and selected problems in the Croatian part of the Roman province of Pannonia, Migotti B. (ed.), BAR International Series 2393, Oxford.

- Lengyel, A., Radan, G. T. B. 1980, *The Archaeology of Roman Pannonia*, Budapest.
- Lolić, T. 2003, Colonia Flavia Siscia, in: *The Autonomous Towns of Noricum and Pannonia, Pannonia I*, Situla 41, 131–152.
- Lozok, J. 2008, Lokalitet: Stružani-Vrtlovi, Kučišće, Veliki Trstenik-sjever, *Hrvatski arheološki godišnjak*, 4/2007, 104–106.
- Lyman, R. L. 1994, *Vertebrate Taphonomy*, Cambridge University Press, Cambridge.
- Makjanić, R. 1990, Terra sigillata iz Orešca. Zbirka Vincek i Radijevac, *Prilozi Instituta za arheologiju*, Vol. 7, 31–44.
- Makjanić, R. 1996, Sisak – terra sigillata, iskopavanja 1990, *Opvscvla archaeologica*, Vol. 20, 91–118.
- Marković, Z. 1984, Prilog poznavanju kontinuiteta naseljavanja terena oko Delova, *Podravski zbornik*, 10, 295–319.
- Marković, Z. 1993, Nekoliko zanimljivih arheoloških nalaza iz Koprivničke Podravine, *Muzejski vjesnik. Glasilo muzeja sjeverozapadne Hrvatske*, 16/1993, Križevci, 26–30.
- Manning, W. H. 1985, *Catalogue of the Romano-British iron tools, fittings and weapons in the British Museum*, London.
- Mantovanelli, L. 2012, La lana nella medicina romana: Celso, Scribonio, Plinio, in: *La lana nella Cisalpina romana, Economia e società*, M. S. Busana, P. Basso, A. R. Triconi (eds.), Padova, 633–640.
- Maróti E. 1985, Römischer Wachturm auf dem Kalvarienhügel von Pilisszántó, *Studia Comitatus*, 17, 159–184.
- Matijašić, R. 1986, *Lateres Siscienses (ad CIL III 11378 – 11386)*, *Vjesnik Arheološkog muzeja u Zagrebu*, 3. ser. XIX, 203–215.
- Matthews, K. D. 1969, *Scutella, Patella, Patera, Patina: a study of Roman dinnerware*, Philadelphia, University of Pennsylvania.
- Mauné, S., Monteix, N., Poux, M. (eds), 2013, Cuisines et boulangeries en Gaule Romaine, *Gallia* 70.1.
- Mayer, A. 1935, Iasi, *Vjesnik hrvatskoga arheološkog društva*, n.s. 16 (1-2), 69–82.
- Medgyes, M. 2002, Késő Római telep a "Tokorcs kincs" lelőhelyén (Late Roman settlement at the site of the Tokorcs coin – hoard), *Savaria*, 25/3 (2000–2001), 99–132.
- Mikl Curk, I. 1973, Zapažanja o temni rimski kuhinjski lončeni posodi v Sloveniji, *Arheološki vestnik*, 24, 883–900.
- Miletić, I. 2007, Struktura keramičkoga materijala, *Opvscvla archaeologica*, Vol. 31, 347–362.
- Miličević Bradač, M. 1999–2000, »Brómos ou Brómios - Bromo, a ne Bromije (Anth. Pal. 9. 368)«, *Opvscvla archaeologica*, Vol. 23–24, 65–76.
- Milošević, P. 1987, Naoružanje i oprema rimskog ratnika u doba osvajanja i konsolidacije doline Save in: *Počeci romanizacije u jugoistočnom delu provincije Panonije*, Novi Sad, 11–25, 67–72.
- Milošević, P. 1995, Rimski nekropola na izlaznici mitrovačke petlje (26), in: *Arheološka istraživanja duž auto puta kroz Srem*, Novi Sad, 195–218.
- Mirnik, I. 1981 *Coin hoards in Yugoslavia*, BAR International Series, 95, Oxford.
- Mirnik, I. 1986, O numizmatičkoj topografiji Virovitičkog kraja, in: *Virovitički zbornik*, Mohorovičić A. (ed.), Virovitica, 107–112.
- Moeller, W. O. 1969, The Male Weavers at Pompeii, in: *Technology and Culture*, 561–566.
- Moosbauer, G. 1999, Handwerk und Gewerbe in den ländlichen Siedlungen Raetiens, in: *Monographies instrumentum*, 9, *Artisanat et productions artisanales en milieu rural dans les provinces du nord-ouest d l'empire romaine, Actes du colloque d'Erpeldange, mars 1999*, Montagnac, 217–234.
- Motyková, K., Drda, P., Rybová, A. 1991, Some imports from the end of the Roman period at the site of Závist in: *Archaeology in Bohemia 1986–1990*, Prag, 56–63.
- Müller, R. 1971, A Zalalövői császárkori tumulusok (Die Hügelgraber aus der Kaiserzeit in Zalalövő), *Archaeologiai Értesítő*, 98/1, 3–23.
- Nađ, M. 2012, Coin circulation AD 193–423, in: *The Archaeology of Roman Southern Pannonia, The state of research and selected problems in the Croatian part of the Roman province of Pannonia*, (B. Migotti, ed.), BAR International Series 2393, 385–409.
- Nelson, M. 2005, *The Barbarian's beverage, A History of Beer in Ancient Europe*, London, New York.
- Nemeth-Ehrlich, D. 1986a, Komin - Pyri, *Obavijesti Hrvatskog arheološkog društva*, XV/1, 23.
- Nemeth-Ehrlich, D. 1986b, Ludbreg - Iovia Botivo, Ludbreg, in: *40 godina arheoloških istraživanja u sjeverozapadnoj Hrvatskoj*, Zagreb, 118, 120–121.
- Nemeth-Ehrlich, D. 1994, 219. Ščitarjevo, terme, in: *Zagreb prije Zagreba*, Zagreb, 121–122.
- Nemeth-Ehrlich, D., Kušan Špalj, D. 2003, *Municipium Andautonia*, in: *The Autonomous Towns of Noricum and Pannonia, Pannonia I*, Situla 41, 107–129.
- Nemeth-Ehrlich, D., Kušan Špalj, D. 2007, *Dvije tisuće godine Andautonije, od rimskog grada do arheološkog parka*, Zagreb.
- Nielsen-Marsh, C. M., Smith, C. I., Jans, M. M. E., Nord, A., Kars, H., Collins, M. J. 2007, Bone diagenesis in the European Holocene II: taphonomic and environmental considerations, *Journal of Archaeological Science* 34 (9), 1523–1531.
- Nikolić-Đorđević, S. 2000, Antička keramika Singidunuma, *Singidunum II*, 11–244.
- Nikolić-Đorđević, S. 2002, Nalazi antičke keramike sa prostora konaka kneginje Ljubice, *Singidunum III*, 221–236.
- Ortisi, S. 2006, Ein spätantikes Messer mit Inschrift aus Aelia Augusta – Augsburg, *Bayerische Vorgeschichtsblätter*, 71, 121–128.
- Orton, C., Tyers, P., Vince, A. 1994, *Pottery in archaeology*, Cambridge University Press.
- Ottományi, K. 2004, A Budakalász – Luppa Csárdai Órtorony késő Római kerámiaja, *Studia Comitatus*, 28, 269–295.
- Ottományi, K. 2005, Die Spätlatènezeitlich-Römische Siedlung von Budaoers, *Acta Archaeologica Academiae Scientiarum Hungaricae*, LVI, 1–3, Budapest, 67–132.
- Ottományi, K., Soszartits, O. 1998, Spätromischer Töpferofen im südlichen Stadteil von Savaria, *Savaria*, 23/3, (1996–1997), 145–216.
- Ožanić, I. 1998, Gradina Osječenica – antičko razdoblje, *Opvscvla archaeologica*, Vol. 22, 27–80.



- Ožanić, I. 2004a, *Tipologija rimske keramike iz Vinkovaca*, Magistarski rad, Sveučilište u Zagrebu, Zagreb.
- Ožanić, I. 2004b, *Olivijina cibalitanska kuharica, recepti rimskih autora prilagođeni 21. stoljeću*, Vinkovci.
- Ožanić, I. 2008, Roman coarse pottery from *Cibalae*: a typology, *Rei Creatariae Romanae Favtorvm*, Acta XL, Dürres, 185–189.
- Ožanić Roguljić, I. 2009, Rimski nalazi s lokaliteta Liskovac – Južna obilaznica Vinkovaca, *Prilozi Instituta za arheologiju u Zagrebu*, Vol. 26, 79–142.
- Ožanić Roguljić, I. 2011, De caso faciendo. *Prilozi Instituta za arheologiju*, Vol. 27, 171–176.
- Parović-Pešikan, M. 1971, Excavations of a Late Roman villa at Sirmium, *Sirmium II*, 34–36.
- Parović-Pešikan, M. 1973, Excavations of a Late Roman Villa at Sirmium, *Sirmium III*, 22–26.
- Payne, S. 1973, Kill-off patterns in sheep and goats: The mandibles from Aşvan Kale, *Anatolian Studies*, 23, 281–303.
- Payne, S. 1985, Morphological Distinctions between the Mandibular Teeth of Young Sheep, *Ovis*, and Goats, *Capra*, *Journal of Archaeological Science*, 12 (2), 139–147.
- Peacock, D. P. S. 1997, *La ceramica romana tra archeologia ed etnografia* (Pottery in the Roman World, an ethnoarchaeological approach), Edipuglia, S. Spirito.
- Peters, J. 1998, *Römische Tierhaltung und Tierzucht: eine Synthese aus archäozoologischer Untersuchung und schriftlich-bildlicher Überlieferung*. Series: Passauer Universitätsschriften zur Archäologie, 5, Rahden/Westf., Leidorf.
- Petru, S., Petru, P. 1978, *Neviodunum (Drnovo pri Krškem)*, Ljubljana.
- Peña, J. T. 2007, *Roman Pottery*, Cambridge University Press.
- Petznek, B. 1998, Römerzeitliche Gebrauchskeramik aus Carnuntum, Teil 1, *Carnuntum Jahrbuch 1997*, (1998), 168–319.
- Pietsch, M. 1983, Die römischen Eisenwerkzeuge von Saalburg, Feldberg und Zugmantel, *Saalburg Jahrbuch*, 39, 5–132.
- Pleterski, A. 1987, Sebenjski zaklad, *Arheološki vestnik*, 38, 237–330.
- Plesničar-Gec, Lj. 1972, *Severno emonsko grobišče*, Katalogi in monografije 8, Narodni muzej, Ljubljana.
- Plesničar-Gec, Lj. 1977, *Keramika emonskih nekropol*, Mestni muzej, Ljubljana.
- Plesničar-Gec, Lj. 2006, *Emonska forum*, Koper.
- Poczy, Sz. K. 1957, Keramik in: *Intercisa, Acta Archaeologica Academiae Scientiarum Hungaricae*, XXXVI, 29–139.
- Pollard, R. J. 1988, *The Roman Pottery of Kent*, Kent Archaeological Society.
- Popović, I. 1988, *Antičko oruđe od gvožđa u Srbiji*, Beograd.
- Poux, M., Argant, T., Bouby, L., Clément, B., Gilles, A., Leperlier, M., Tillier, M., Tripier, A. 2013, Une *culina* de type pompéien en territoire lyonnais, *Gallia*, 70.1, 135–164.
- Radman-Livaja, I., Ivezic, H. 2012, A Review of South-Pannonian Indigenous Antroponomy, in: *The Archaeology of Roman Southern Pannonia, The state of research and selected problems in the Croatian part of the Roman province of Pannonia*, Migotti B., (ed.), BAR International Series 2393, 137–158.
- Radnóti, A. 1938, *Die römischen Bronzegefäße von Pannonien*, Dissertationes Pannonicae II/6.
- Radović, S. 2012, Analiza faune iz srednjovjekovne utvrde Paka kod Novog Marofa, in: *Arheologija varaždinskog kraja i srednjeg Podravlja*, Šimek M. (ed.), *Izdanja Hrvatskog arheološkog društva*, 28, Zagreb, 297–301.
- Rapanić, Ž. 1972, Antički brod s teretom keramike kod Vignja, *Zbornik otoka Korčule*, 2, Zagreb, 141–147.
- Redó, F. 2003, *Municipium Aelium Salla*, in: *The Autonomous Towns of Noricum and Pannonia, Pannonia I*, Situla 41, 191–235.
- Reitz, E. J., Wing, E. S. 1999, *Zooarchaeology*, Cambridge University Press, Cambridge.
- RIC - Mattingly, H., Sydenham, E. A. 1930, Antoninus Pius to Commodus, in: *The Roman Imperial Coinage*, Vol. III, London (first edition 1933).
- RIC - Sutherland, C. H. V. 1967, From Diocletian's reform (A. D. 294) to the death of Maximinus (A. D. 313), in: *The Roman Imperial Coinage*, Vol. VI, Sutherland C. H. V., Carson R. A. G. (eds.), London (first edition 1933).
- RIC - Webb, P. H. 1968, in: *The Roman Imperial Coinage*, Vol. V part II, Mattingly H., Sydenham E. A. (eds.), London (prvo izdanje 1933).
- RIC - Kent, J. P. C. 1981, The family of Constantine I, A. D. 337–364, in: *The Roman Imperial Coinage*, Vol. VIII, Sutherland C. H. V., Carson R. A. G. (eds.), London (first edition 1933).
- Riedel, A. 1996, Archaeozoological investigations in North-eastern Italy: the exploitation of animals since the Neolithic, *Preistoria Alpina*, 30, 43–94.
- Robinson, H. S. 1959, Pottery of the Roman Period, *The Athenian Agora*, Vol. 5, New Jersey.
- Ružić, M. A. 1994, *Rimsko staklo u Srbiji*, Univerzitet u Beogradu, Filozofski fakultet, Centar za arheološka istraživanja, knj. 13, Beograd.
- Rützi, B. 1991, *Die römischen Gläser aus August und Kaiser August*, Text, Bd. 13/1, Augst.
- Rye, O. S. 1988, *Pottery Technology*, Manuals on archaeology, 4, Washington.
- Sági, K. 1960, Die Spätromische Bevölkerung der Umgebung von Keszthely, *Acta Archaeologica Academiae Scientiarum Hungaricae*, XII, 187–256.
- Sabolić, D. (ed.). 2007, *Zapadna virovitička obilaznica*, Virovitica.
- Salajić, S. 2002, Probna arheološka iskopavanja u općini Voćin, lokalitet "Lenjija", *Glasnik slavonskih muzeja*, XXXVI, Našice, 70–73.
- Salajić, S. 2008, Orešac – antički *Bolentio*, *Glasnik slavonskih muzeja*, 5, XXVIII, Požega, 67–72.
- Sanader, M. 1995, *Vilicus* – prilog poznavanju djelatnosti upravitelja imanja i državnog namještenika, *Opvscvla archaeologica*, Vol. 19, 97–109.
- Sanader, M. 2008, *Imago provinciarum*, Zagreb.
- Schejbal, B. 2003a, Prilog rekonstrukciji rimskih komunikacija na jaškom municipalnom teritoriju, *Izdanja Hrvatskog arheološkog društva*, 21, Zagreb, 95–120.
- Schejbal, B. 2003b, Nova razmatranja o *Aquae Balissae* i narodu Jaza. Pejzaž – Vode – Etimologija – Kultovi – Mitologija, pitanja atribucije i kontinuiteta, *Opvscvla archaeologica*, Vol. 27, 393–416.

- Schejbal, B. 2004, Municipium Iasorum (*Aquae Balissae*), *The Autonomous towns of Noricum and Pannonia, Pannonia II*, Situla 42, 99–129.
- Schmid, E. 1972, *Atlas of Animal Bones – Knochenatlas*, Elsevier, Amsterdam, London, New York.
- Schörgendorfer, A. 1942, *Die römische Keramik der Ostalpländern*, Brunn – München – Wien.
- Sekelj Ivančan, T. 2010a, Keramički pršljeni iz Torčeca, *Vjesnik arheološkog muzeja u Zagrebu*, 3. ser. XLIII, 381–398.
- Sekelj Ivančan, T. 2010b, *Podravina u ranom srednjem vijeku. Rezultati arheoloških istraživanja ranosrednjovjekovnih nalazišta u Torčecu*, Monographiae Instituti archaeologici 2, Zagreb.
- Sekelj Ivančan, T., Tkalčec, T. 2008, Medieval settlements in the Virovitica Region of the Drava River Basin in the period from the 7<sup>th</sup> to the 11<sup>th</sup> centuries, 13th Annual meeting of the European association of archaeologists, 18th–23rd September 2007, in: *Srednji vek. Arheološke raziskave med Jadranskim morjem in Panonsko nižino*, Guštin, M. (ed.), Ljubljana, 113–128.
- Sekelj Ivančan, T., Tkalčec, T. 2010, Rekonstrukcija kuće iz ranosrednjovjekovnog naselja Virovitica – Kiškorijski jug, *Prilozi Instituta za arheologiju*, Vol. 27, 217–224.
- Sekelj Ivančan, T. 2014, Četvrta sezona arheoloških istraživanja nalazišta Virje-Volarski breg/Sušine, *Annales Instituti Archaeologici*, X, 99–103.
- Silver, I. A. 1969, The Ageing of Domestic Animals, in: Brothwell D., Higgs E. (eds.), *Science in Archaeology: A survey of Progress and Research*, 2<sup>nd</sup> Edition, Praeger, New York, 283–302.
- Simić, V., Popović, S., Jojić, D. 1988, *Anatomski praktikum usporedne anatomije domaćih sisara – Prvi deo*. Naučna knjiga, Beograd.
- Slapšak, S. 1989, *Apicije – o kuvanju*, Zagreb.
- Soproni, S. 1980, Roads, in: *The Archaeology of Roman Pannonia* Lengyel A., Radan G. T. B. (eds.), Budapest, 207–218.
- Spaer, M. 1988, The Pre – Islamic Glass Bracelets od Palestine, *Journal of Glass Studies*, 30, 51–61.
- Spaer, M. 2001, Ancient glass in the Israel Museum: beads and other small objects, Jerusalem, The Israel Museum.
- Sokač-Štimac, D. 1976, "Radovanačko brdo kod Velike", *Arheološki preglad*, 18, 89–90.
- Sperti, L. 2012, Un altare funerario con scena di filatura dal territorio Friulano, in: *La lana nella Cisalpina romana, Economia e società*, Busana M. S., Basso P., Triconi A. R. (eds.), Padova, 513–522.
- Strmčnik-Gulič, M. 1993, Skrb za izročilo preteklosti, *Ptujski arheološki zbornik, ob 100-letnici muzeja in Muzejskega društva*, Ptuj, 481–504.
- Szabó, A., Fazekas, F., Kófalvi, Cs. 2007, Gebrauchskeramik in: *Die Römische Siedlung bei Babarc*, Fazekas F. (ed.), Leidorf, 117, T. 19. 147.
- Szőnyi, E. T. 1996, Römerzeitliche Altansässigensiedlung von Ménfőcsanak (Umgebung von Győr), *Arheološki vestnik*, 47, 249–256.
- Šarić, I. 1975, Antičko naselje u Petrijancu, *Materijali XIII*, Varaždin, 49–62.
- Šarić, M. 1979–1980, Rimski grob u Topuskom, *Vjesnik arheološkog muzeja u Zagrebu*, ser. 3, 125–150.
- Šašel Kos, M. 2003, Emona was in Italy not in Pannonia, *The Autonomous towns of Noricum and Pannonia, Pannonia I*, Situla 41, 11–19.
- Šercelj, A. 1990, Zanimive karpološke najdbe v dveh rimskih grobovih v Rabeljški vasi pri Ptuj, *Arheološki vestnik*, 41, 309–312.
- Šimić-Kanaet, Z. 1999, *Komparativna analiza tehnologije protohistorijske i ranorimske keramike na području sjeverne Hrvatske*, Sveučilište u Zagrebu, Zagreb.
- Šimić-Kanaet, Z. 2003, Keramika in: M. Sanader: *Tilurium I, Istraživanja 1997–2001*, Zagreb, 109–188.
- Šonje, A. 1991, *Putovi i komunikacije u prethistoriji i antici na području Poreštine*, Poreč.
- Šoštarić, R. 2003, *Vegetacijske promjene u postglacijalu u Hrvatskoj*, Doktorska disertacija, Sveučilište u Zagrebu, Zagreb.
- Šoštarić, R. 2004, Arheobotanička analiza nalaza s lokaliteta Točec – Gradić / Archaeobotanical analysis of findings from Torčec – Gradić archaeological site, *Podravina* 3 (6), 107–115.
- Šoštarić, R. 2006, 7. Ekskurs: Arheobotaničke analize / 7. Ekskurs: Archäobotanische Analyse. – In: Sekelj Ivančan, T., Tkalčec, T.: Slaveno paljevinsko groblje na položaju Duga ulica 99 / Slawisches Brandgräberfeld am Standort Duga ulica 99 in Vinkovci, *Prilozi Instituta za arheologiju*, Vol. 23, 141–212 (200–201).
- Šoštarić, R., Küster, H. 2001, Roman plant remains from Veli Brijun (island of Brioni), Croatia, *Vegetation History and Archaeobotany*, 10, 227–233.
- Šoštarić, R., Dizdar, M., Kušan, D., Hršak, V., Mareković, S. 2006, Comparative Analysis of Plant Finds from Early Roman Graves in Ilok (Cuccium) and Šćitarjevo (Andautonia), Croatia – A Contribution to Understanding Burial Rites in Southern Pannonia, *Collegium Antropologicum*, 30 (2), 429–436.
- Šoštarić, R., Radović, S., Jelinčić Vučković, K., Ožanić Roguljić, I. (in press), Diet in Roman Village of Virovitica Kiškorijski South, Croatia, *Collegium Antropologicum*.
- Thomas, E. B. 1955, Die Römerzeitliche villa von TÁC-Fövenypusta, *Acta Archaeologica Academiae Scientiarum Hungaricae*, VI, 1–4, 79–152.
- Thomas, E. B. 1964, *Römische Villen in Pannonien*, Budapest.
- Thurmond, D. L. 2007, *A Handbook of Food Processing in Classical Rome: For Her Bounty No Winter*, Leiden, Boston.
- Tillier, M. 2012, *Etude carpologique de structures portuaires immergées du site romain de Caska (Ile de Pag, Croatie)*, Master 1 Thesis (mscr.), Paul Valéry University, Montpellier III.
- Tkalčec, T., Karavanić, S., Šiljeg, B., Jelinčić, K., 2007, Novootkrivena arheološka nalazišta uz rječicu Veliku kod mjesta Majur i Ladinec, *Cris*, IX, Br. 1/2007, 5–25.
- Tomičić, Ž. 1979, Zaštitna arheološka istraživanja u Martinu na Muri, *Muzejski vjesnik, Glasilo muzeja sjeverozapadne Hrvatske* 2/1979, Koprivnica, 40–43.
- Tomičić, Ž. 1986, Martin na Muri, Čakovec in: *40 godina arheoloških istraživanja u sjeverozapadnoj Hrvatskoj*, Koprivnica, 120.
- Tomović, M. 1984, Tekija, keramika sa utvrđenja, *Starinar*, XXXIII–XXXIV, (1982–1983), 346–350.
- Topál, J. 1981, *The Southern Cemetery of Matrica (Százhalombatta - Dunafüred)*, Budapest.
- Topál, J. 1993, *Roman Cemeteries of Aquincum, Pannonia. The Western Cemetery (Bécsi Road) I*, Budapest.
- Torma, A. 2007, The Results of Archaeobotanical Investigations, In: *The Roman Settlement near Babarc, Komitat Baranya/Hungary*, Fa-

- zekas, F. (ed.) Passauer Universitätsschriften zur Archäologie, 12, 167.
- Toškan, B., Dirjec, J. 2012, Sesalska makrofavna z območja rimskodobne poselitve na Grubljah pri Vipavi, *Arheološki vestnik*, 63, 139–157.
- Transparentna ljepota: staklo iz Hrvatskih muzeja, od pretpovijesti do srednjeg vijeka* 2013, katalog izložbe, Arheološki muzej Zagreb.
- Tušek, I. 1993, Rimsko grobišče na novi obvoznici ob Potrčevi cesti v Ptuj, *Ptujski arheološki zbornik, ob 100-letnici muzeja in Muzejskega društva Ptuj*, 385–448.
- Tyers, P. A. 1999, *Roman Pottery in Britain*, London–New York.
- Vičić, B. 1993, Zgodnjerimsko naselje pod Grajskim gričem v Ljubljani. Gornji trg 15, *Arheološki vestnik*, 44, 153–201.
- Vičić, B. 1994, Zgodnjerimsko naselje pod Grajskim gričem v Ljubljani. Gornji trg 30, Stari trg 17 in 32. *Arheološki vestnik*, 45, 25–80.
- Vičić, B. 2002, Zgodnjerimsko naselje pod Grajskim gričem v Ljubljani. Gornji trg 3. *Arheološki vestnik*, 53, 193–221.
- Vidošević, I. 2003, Rimski keramika s lokaliteta Starčevićeve ulice 37 u Sisku, *Godišnjak Gradskog muzeja Sisak*, III–IV, 11–74.
- Vikić, B. 1971, Karakter rimske keramike južne Panonije i problematika njene tipologije i kronologije, *Materijali*, VIII, Zenica, 91–110.
- Vikić-Belančić, B. 1965, Neka obilježja ranocarske keramike u Jugozapadnoj Panoniji, *Starinar*, XIII/XIV, 89–112.
- Vikić-Belančić, B. 1967, *Rimska keramička proizvodnja na području Save i Drave od I–IV st. s osobitim obzirom na proizvodnju glinenih svjetiljki*, Doktorska disertacija, Sveučilište u Zagrebu, Zagreb.
- Vikić-Belančić, B. 1968a, Keramika i njen udio u trgovinskom prometu južne Panonije u rimsko carsko doba, *Arheološki vestnik*, 19, 509–533.
- Vikić-Belančić, B. 1968b, Istraživanja u Jalžabetu kao prilog upoznavanju života u zaleđu dravskog limesa, *Vjesnik Arheološkog muzeja u Zagrebu*, 3. ser. III, Zagreb, 76–102.
- Vikić-Belančić, B. 1970, Istraživanja u Vinkovcima 1966. god., *Vjesnik Arheološkog muzeja u Zagrebu*, ser. 3. IV, 159–188.
- Vikić-Belančić, B. 1974, Prilog istraživanju antičkog naseobinskog kompleksa u V. Toplicama, *Vjesnik Arheološkog muzeja u Zagrebu*, ser. 3, VI–VII, (1972–1973), 75–127.
- Vikić-Belančić, B. 1975, Keramika grublje fakture u južnoj Panoniji s osobitim obzirom na urne i lonce, *Arheološki vestnik*, 26, 25–45.
- Vikić-Belančić, B. 1983–1984, Sustavna istraživanja u Ludbregu od 1968. – 1979. god., *Vjesnik arheološkog muzeja Zagreb*, 3. ser. XVI–XVII, 119–166.
- Vikić-Belančić, B., Gorenc, M. 1958, Arheološka istraživanja antiknog kupališta u Varaždinskim Toplicama od 1953. – 1955. godine, *Vjesnik Arheološkog muzeja u Zagrebu*, 3. ser. I, 75–127.
- Vitruvije, 1999, *Deset knjiga o arhitekturi*, (prijevod prof. dr. Matija Lopac).
- Vrsalović, D. 1974, *Istraživanja i zaštita podmorskih arheoloških spomenika u SR Hrvatskoj*, Zagreb.
- Wiethold, J. 2000, How to trace the 'Romanisation' of central Gaul by archaeobotanical analysis? - Some considerations on new archaeobotanical results from France Centre-Est, In: *Actualités de la Recherche en Histoire et Archéologie agraires. Actes du colloque international AGER V*, Besançon, Favory F., Vignot A. (Eds.) (Annales Littéraires, 764. Série 'Environnement, sociétés et archéologie' (Presses Universitaires Franc-Comtoises, Besançon,)) 269–282.
- Wiewegh, Z. 2001, Rimski keramika iz Siska s lokaliteta "Kovnica", istraživanja iz godine 1985, *Opuscula archaeologica*, Vol. 25, 89–149.
- Wiewegh, Z. 2003, *Jugoistočna nekropola Siscije*, Sisak.
- Wild, J. P. 1987, The Roman Horizontal Loom, *American Journal of Archaeology*, 91, 459–471.
- Wild, J. P. 1999, Textile manufacture: a rural craft? In: *Monographies instrumentum, 9, Artisanat et productions artisanales en milieu rural dans les provinces du nord-ouest de l'Empire romain, Actes du colloque d'Erpeldange, mars 1999*, Montagnac.
- Willems, S. 2005, *Roman Pottery in the Tongeren reference collection: mortaria and coarse wares*, Brussel.
- Zabehlicky-Scheffenecker, S. 1998, Magdaledsberg: Rapport commercial fra Cisalpina e regione Transalpina, in: *Optima via*, Atti del convegno internazionale di studi POSTUMIA, storia e archeologia di una grande strada romana alle radici dell'Europa, Sena Chiesa G., Arslan E. A. (eds.), Cremona 13–15 giugno 1996, Cremona, 283–292.
- Zaninović, M. 1976, Iliri i vinova loza, *Godišnjak Centra za balkanološka ispitivanja*, XIII/11, 261–271.
- Zaninović, M. 1993, Classis Flavia Pannonica, *Izdanja Hrvatskog arheološkog društva*, 16, Zagreb, 53–58.
- Zbirka Pavletić, 2004, *Na tragovima vremena, iz arheološke zbirke Mateja Pavletića*, (eds. J. Balen, Ž. Demo, I. Ožanić, I. Radman-Livaja, A. Rendić-Miočević, I. Uračić), katalog izložbe, Zagreb.
- Zohary, D., Hopf, M. 2000, *Domestication of Plants in the Old World*, Oxford.
- Žižek, I. 2004, Katalog predmeta in: *Rimljani, steklo, glina, kamen*, Celje – Maribor – Ptuj, 124–147.

#### Antički izvori:

- Ammianus Marcellinus, Res Gestae a fine Corneli Taciti* <http://www.thelatinlibrary.com/ammianus.html> (16.5.2014.)
- Anthimus, De observatione ciborum*  
Gordon M. Messing, Remarks on Anthimus *De observatione ciborum* *Classical Philology*, 37, 1942.
- Apicius, Apicius de re coquinaria*  
*O kuvanju*/Apicije; Edited and translated *Svetlana Slapšak*. Latina et Graeca, Zagreb, 1989.
- Athenaeus, Deipnosophistae*  
The Learned Banqueters, Book I–VII Edited and translated S. Douglas Olson, Loeb Classical Library, Harvard, 2007.
- Cato Agr., Marcus Porcius Cato Censorius, De agricultura* <http://www.thelatinlibrary.com/cato.html> (20.12. 2010.).
- Columella DRR, L. Junius Moderatus Columella, De Re Rustica* <http://www.thelatinlibrary.com/columella.html>, (14.4.2014.)
- Dio Cassius, Dio Cassius Cocceianus, Ποσειδωνίου ἱστορία*  
M. Šašel Kos, Zgodovinska podoba prostora med Akvilejo, Jadranom in Sirmijem pri Kasiju Dionu in Herodijanu, Ljubljana, 1986.
- Galenus, Aelius Galenus or Claudius Galenus, De Compositione Medicamentorum Secundum Locum* <http://onlinebooks.library.upenn.edu/webbin/book/lookupname?key=Galen> (16.5.2014.)

*Palladius OA, Rutilius Taurus Aemilianus Palladius, Opus agriculturae*  
<http://www.forumromanum.org/literature/palladius/agr1.html>  
16.5.2014.

*Plinius NH, Gaius Plinius Secundus Naturalis Historia*  
[http://la.wikisource.org/wiki/Naturalis\\_Historia](http://la.wikisource.org/wiki/Naturalis_Historia)  
*Varro RR, Marcus Terentius Varro. Res rusticae.*  
<http://www.thelatinlibrary.com/varro.html> (20. 12. 2010.).

*Vegetius, Publius Flavius Vegetius Renatus, Epitoma rei militaris,*  
Publije Flavije Vegecije Renat: Sažetak vojne vještine, transl. and com.  
by T. Shek Brnardić, / Introductory study by V. Brnardić, (Golden  
marketing, Zagreb, 2002)

*Sv Jeronim Comm, Commentariorum In Isaim Prophetam Libri Duodevi-*  
*ginti*  
[http://www.documentacatholicaomnia.eu/02m/0347-0420,\\_Hieronymus,\\_Commentariorum\\_In\\_Isaim\\_Prophetam\\_Libri\\_Duodeviginti,\\_MLT.pdf](http://www.documentacatholicaomnia.eu/02m/0347-0420,_Hieronymus,_Commentariorum_In_Isaim_Prophetam_Libri_Duodeviginti,_MLT.pdf) (15.1.2105)

#### **Elektronički izvori:**

<http://www.vivre-et-survivre.com/bien-sinstaller-faire-table-feu/>  
<http://www.fraternite.net/forum/voirtopic.php?topic=6743&forum=55>  
<http://www.unc.edu/~klaxton/kathy.html>



9.

**Podaci o suradnicima na knjizi**

*Authors info*



**ANJA BERTOL**

Arheološki muzej Zagreb  
Trg Nikole Šubića Zrinskog 19  
10000 Zagreb  
abertol@amz.hr

**KARMEN FARAC**

Trg Ivana Kukuljevića 3  
10000 Zagreb  
karmen.kaa@gmail.com

**DR. SC. JOSIP HALAMIĆ**

Hrvatski geološki institut  
Sachsova 2  
10000 Zagreb  
jhalamic@hgi-cgs.hr

**DR. SC. IVANA OŽANIĆ ROGULJIĆ**

Institut za arheologiju  
Ljudevita Gaja 32  
10000 Zagreb  
ivana.ozanic@iarh.hr

**DR. SC. IVAN RADMAN-LIVAJA**

Arheološki muzej Zagreb  
Trg Nikole Šubića Zrinskog 19  
10000 Zagreb  
iradmanl@gmail.com

**DR. SC. SINIŠA RADOVIĆ**

Hrvatska akademija znanosti i umjetnosti  
Zavod za paleontologiju i geologiju kvartara  
Ante Kovačića 5/II  
10000 Zagreb  
sinisa.radovic@gmail.com

**DR. SC. TAJANA SEKELJ IVANČAN**

Institut za arheologiju  
Ljudevita Gaja 32  
10000 Zagreb  
tajana-sekelj.ivancan@iarh.hr

**DR. SC. RENATA ŠOŠTARIĆ**

Prirodoslovno matematički fakultet  
Biološki odsjek, Botanički zavod  
Botanički zavod  
Marulićev trg 20/2  
10000 Zagreb  
rsostar@biol.pmf.hr

**DR. SC. TATJANA TKALČEC**

Institut za arheologiju  
Ljudevita Gaja 32  
10000 Zagreb  
tatjana.tkalcec@iarh.hr

**KRISTINA TURKALJ**

Institut za arheologiju  
Ljudevita Gaja 32  
10000 Zagreb  
kristina.turkalj@iarh.hr





# POKROVITELJI

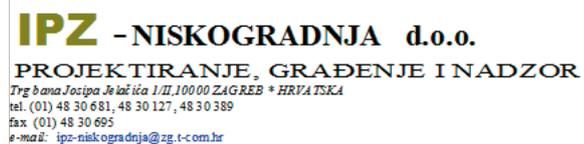

član PBZ Grupe



