

Crkva Uznesenja Blažene Djevice Marije u Gori kraj Petrinje i faze ukopavanja grobova na prostoru sakristije

Belaj, Juraj; Sirovica, Filomena; Bedić, Željka

Source / Izvornik: **Prilozi Instituta za arheologiju u Zagrebu, 2021, 38, 89 - 114**

Journal article, Published version

Rad u časopisu, Objavljena verzija rada (izdavačev PDF)

<https://doi.org/10.33254/piaz.38.2.3>

Permanent link / Trajna poveznica: <https://um.nsk.hr/um:nbn:hr:291:608764>

Rights / Prava: [Attribution 3.0 Unported](#)/[Imenovanje 3.0](#)

Download date / Datum preuzimanja: **2024-11-19**



INSTITUT ZA
ARHEOLOGIJU

Repository / Repozitorij:

[RIARH - Repository of the Institute of archaeology](#)

UDK 902
ISSN 1330-0644
Vol. 38/2
ZAGREB, 2021.

PRILOZI

Instituta za arheologiju u Zagrebu

Pril. Inst. arheol. Zagrebu, 38/2/2021
Str./Pages 1–218, Zagreb, 2021.

Izdavač/*Publisher*
INSTITUT ZA ARHEOLOGIJU
INSTITUTE OF ARCHAEOLOGY

Adresa uredništva/*Address of the editor's office*
Institut za arheologiju/*Institute of archaeology*
HR–10000 Zagreb, Jurjevska ulica 15
Hrvatska/*Croatia*
Telefon/Phone ++385/(0)1 61 50 250
Fax ++385(0)1 60 55 806
e-mail: urednistvo.prilozi@iarh.hr
<http://www.iarh.hr>

Glavni i odgovorni urednik/*Editor in chief*
Marko DIZDAR

Tehnički urednici/*Technical editors*
Marko DIZDAR
Katarina BOTIĆ

Uredništvo/*Editorial board*
Marko DIZDAR, Snježana VRDOLJAK, Viktória KISS (Budapest, HUN) (prapovijest/*Prehistory*), Goranka LIPOVAC VRKLJAN, Ivan RADMAN-LIVAJA (antika/*Antiquities*), Tajana SEKELJ IVANČAN, Katarina Katja PREDOVNIK (Ljubljana, SLO), Natascha MEHLER (Wien, AUT), Tatjana TKALČEĆ (srednji vijek i novi vijek/*Middle Ages and Modern era*), Predrag NOVAKOVIĆ (Ljubljana, SLO) (metodologija/*Methodology*)

Izdavački savjet/*Editorial advisory board*
Dunja GLOGOVIĆ (Zagreb), Ivor KARAVANIĆ (Zagreb), Laszlo KÓVACS (Budapest, HUN), Kornelija MINICHREITER (Zagreb), Aleksandar RUTTKAY (Nitra, SK), Ivančica SCHRUNK (Minneapolis, USA), Željko TOMIČIĆ (Zagreb), Ante UGLEŠIĆ (Zadar)

Prijevod na engleski/*English translation*
Inga VILOGORAC BRČIĆ, Kristina DESKAR, Igor KULENOVIĆ, Irena RADIĆ ROSSI, Saba RISALUDDIN

Lektura/*Language editor*
Ivana MAJER, Marko DIZDAR (hrvatski jezik/*Croatian*)
Marko MARAS, Kristina DESKAR (engleski jezik/*English*)

Korektura/*Proofreads*
Katarina BOTIĆ

Grafičko oblikovanje/*Graphic design*
Umjetnička organizacija OAZA

Računalni slog/*Layout*
Hrvoje JAMBREK

Tisak/*Printed by*
Sveučilišna tiskara d.o.o., Zagreb

Naklada/*Issued*
400 primjeraka/400 copies

Prilozi Instituta za arheologiju u Zagrebu uključeni su u sljedeće indekse/
Prilozi Instituta za arheologiju u Zagrebu are included in following indices:
DYABOLA – Sachkatalog der Bibliothek – Römisch-Germanische Kommission des Deutschen Archaeologischen Instituts, Frankfurt a. Main
Clarivate Analytics services – Web of Science Core Collection
CNRS/INIST – Centre National de la Recherche Scientifique/L'Institut de l'Information Scientifique et Technique, Vandoeuvre-lès-Nancy
EBSCO – Information services, Ipswich
ERIH – European Reference Index for the Humanities, European Science Foundation, Strasbourg
SciVerse Scopus – Elsevier, Amsterdam

E-izdanja. Publikacija je dostupna u digitalnom obliku i otvorenom pristupu na
<https://hrcak.srce.hr/prilozi-iaz>
E-edition. The publication is available in digital and open access form at
<https://hrcak.srce.hr/prilozi-iaz?lang=en>

Ovaj rad licenciran je pod Creative Commons Attribution By 4.0 međunarodnom licencom /
This work is licenced under a Creative Commons Attribution By 4.0 International Licence



Sadržaj

Contents

Izvorni znanstveni radovi

Original scientific papers

- | | | |
|-----|--|---|
| 5 | IGOR KULENOVIĆ
ŠIME VRKIĆ
VEDRANA GLAVAŠ
NEDA KULENOVIĆ OCELIĆ
Vidljivost kao element strukturiranja krajolika –
Primjer višeperiodnoga arheološkog lokaliteta
Bojnik na ušću rijeke Zrmanje | IGOR KULENOVIĆ
ŠIME VRKIĆ
VEDRANA GLAVAŠ
NEDA KULENOVIĆ OCELIĆ
<i>Visibility as an element of landscape structuring –
An example of multi-period archaeological site
Bojnik at the mouth of Zrmanja river</i> |
| 43 | ADNAN BUSULADŽIĆ
Antičke kopče iz muzejskih zbirki u Bosni i
Hercegovini (izbor nalaza) | ADNAN BUSULADŽIĆ
<i>Buckles of Antiquity from the Museum Collections of
Bosnia and Herzegovina (a selection)</i> |
| 89 | JURAJ BELAJ
FILOMENA SIROVICA
ŽELJKA BEDIĆ
Crkva Uznesenja Blažene Djevice Marije u Gori
kraj Petrinje i faze ukopavanja grobova na prostoru
sakristije | JURAJ BELAJ
FILOMENA SIROVICA
ŽELJKA BEDIĆ
<i>Church of the Assumption of the Blessed Virgin
Mary in Gora near Petrinja and the phases of the
burials in the area of sacristy</i> |
| 115 | MARIN EMIĆ
Kasnosrednjovjekovna plemička kurija
kraj Orahovice – Uvod u razumijevanje
kasnosrednjovjekovne kurije u kontinentalnoj
Hrvatskoj | MARIN EMIĆ
<i>Late Medieval Manor House near Orahovica –
Introduction into the Understanding of a Late
Medieval Manor House in Continental Croatia</i> |
| 157 | INES ŠELENDIĆ
IRENA RADIĆ ROSSI
Novi stakleni nalazi iz tereta broda Gagliana grossa
potonuloga kod otočića Gnalića 1583. | INES ŠELENDIĆ
IRENA RADIĆ ROSSI
<i>New glass finds from the cargo of the ship Gagliana
grossa, sunk near the islet of Gnalić in 1583</i> |

Prethodno priopćenje

- 199 INGA VILOGORAC BRČIĆ
LAURENT BRICAULT
Mithras in Teutoburgium

Prikaz

- 205 DOMAGOJ TONČINIĆ
Studia honoraria archaeologica. Zbornik radova u
prigodi 65. rođendana prof. dr. sc. Mirjane Sanader,
Tončinić D., Kaić I., Matijević V., Vukov M. (eds.)

- 211 UPUTE AUTORIMA

Preliminary report

- INGA VILOGORAC BRČIĆ
LAURENT BRICAULT
Mitra u Teutoburgiju

Book review

- DOMAGOJ TONČINIĆ
*Studia honoraria archaeologica. Special volume
on the occasion of the 65th birthday of prof. dr.
Mirjana Sanader; Tončinić D., Kaić I., Matijević V.,
Vukov M. (eds.)*

- GUIDELINES FOR CONTRIBUTORS

Crkva Uznesenja Blažene Djevice Marije u Gori kraj Petrinje i faze ukopavanja grobova na prostoru sakristije

Church of the Assumption of the Blessed Virgin Mary in Gora near Petrinja and the phases of the burials in the area of sacristy

Izvorni znanstveni rad
Srednjovjekovna arheologija

*Original scientific paper
Medieval archaeology*

UDK/UDC 726:27-788.435(497.5 Petrinja)"10/16"

Primljeno/Received: 15. 09. 2021.
Prihvaćeno/Accepted: 14. 11. 2021.

JURAJ BELAJ
Institut za arheologiju
Jurjevska ulica 15
HR-10000 Zagreb
juraj.belaj@iarh.hr

FILOMENA SIROVICA
Arheološki muzej u Zagrebu
Trg Nikole Šubića Zrinskog 19
HR-10000 Zagreb
fsirovica@amz.hr

ŽELJKA BEDIĆ
Antropološki centar HAZU
A. Kovačića 5
HR-10000 Zagreb
zbedic@hazu.hr

Arheološka istraživanja crkve Uznesenja Blažene Djevice Marije provedena su radi potreba njene potpune obnove. Tim povodom istražen je i prostor njene sakristije na kojem su utvrđena 53 groba. Riječ je o prostorno zaokruženoj cjelini na kojoj je jasno utvrđiv stratigrafski slijed omogućio analizu kronoloških odnosa i njihovu vezu s pojedinim obilježjima istraženih grobnih cjelina. Ponajprije je riječ orijentaciji grobova i položaju ruku pokojnika, zatim prisutnosti čavala, kamenih obloga ili tek ponekog kamena uz pokojnika. Na tim je temeljima, te uz analizu prisutnog pokretnog arheološkog materijala, omogućeno definiranje četiri faze ukopavanja grobova. Usporedbom s rezultatima provedenih radiokarbonskih analiza na uzorcima kostiju pokojnika iz odabranih grobova, pobliže je definiran raspon trajanja pojedinih faza ukopavanja. Podaci dobiveni tim postupkom stavljeni su u širi povijesni kontekst što je omogućilo razmatranje odnosa pojedinih faza ukopavanja prema određenim graditeljskim fazama utvrđenima na nalazištu i specifičnim povijesnim okolnostima u kojima su se te aktivnosti odvijale.

Ključne riječi: groblje, faze ukopavanja, radiokarbonsko datiranje, romanika, gotika, templari, ivanovci, Osmanlije

The archaeological excavation of the Church of the Assumption of the Blessed Virgin Mary was prompted by the need for the complete restoration of the church. On that occasion, the area of the sacristy with 53 graves was excavated as well. This area is spatially separated from the rest of the church and has a readily identifiable stratigraphic sequence that enabled the analysis of chronological relationships and their connection to certain characteristics of excavated grave units. Primarily, those characteristics are the orientation of graves, the arm positions of the deceased individuals, the presence of nails, stone linings, or several stones next to the deceased individual. That, alongside the analysis of the discovered archaeological artefacts, enabled the determination of four burial phases. By comparison to the results of the radiocarbon dating conducted on samples of the deceased individuals' bones the duration of certain burial phases was ascertained. The data acquired this way was put in a wider chronological context, which enabled considerations on the relationships of burial phases in relation to construction phases ascertained at the site and specific historical circumstances in which those activities took place.

Key words: cemetery, burial phases, radiocarbon dating, Romanesque style, Gothic style, Knights Templar, Knights Hospitaller, the Ottomans

UVOD

Crkva Uznesenja Blažene Djevice Marije¹ nalazi se u selu Gora na Banovini, uz jednu od najvažnijih srednjovjekovnih prometnica koja je središte Ugarsko-Hrvatskog Kraljevstva u Panoniji spajala s Jadranom (karta 1). Premda je ovaj lokalitet najpoznatiji po templarskoj crkvi, život je na njemu počeo znatno ranije.² O prapovijesnom i antičkom dobu svjedoče tek poneki ulomci keramike. U zapunama grobova nađeno je i nekoliko primjeraka keramike praškog tipa, izrađene u VII. i VIII. stoljeću (Bekić 2016: 47, 48, sl. 24; 285, T. 72: 1, 4, 7), u vrijeme doseljenja Slavena na područje Mure, Drave i Save.

Iz vremena romanike pronađeni su ostaci polukružne apside romaničke crkve. Premda temelji ostalih zidova romaničke crkve nisu pronađeni, vjerojatno jer su bili poništeni izgradnjom ranogotičke, templarske crkve, smjer pružanja najstarijih grobova ukazuje da je bila donekle drugačije orijentacije od kasnije crkve. Naime, najstariji grobovi orijentirani su bliže smjeru sjeverozapad–jugostok, tj. s otklonom od oko 18–19° u odnosu na orijentaciju ranogotičke crkve i grobova ukopanih uz nju.

Nešto mlađi od njih grobovi su koji prate smjer pružanja ranogotičke crkve i mogu se povezati s vremenom templarske uprave nad posjedima u gorskoj županiji. Templari su te posjede dobivali postupno, prvi poznati stekli su između 1162. i 1172. godine.³ Nije poznato kada su, zajedno sa zemljom, dobili romaničku crkvu u Gori, no posjedovali su je najkasnije za vrijeme kralja Bele III. (1172. – 1196.). Ubrzo su na njenom mjestu iz temelja sagradili novu, ranogotičku crkvu „viteškog“ tipa (sl. 1). Brojni kameni ulomci romaničke crkve ugrađeni su kao *spoliji* u temelje i zidove ranogotičke crkve (Miletić 1999: 144–145; Miletić, Valjato Fabris: 2014, 57).

Nakon što je templarski red ukinut 1312. godine crkvu su, kao i druge posjede u Hrvatskoj, naslijedili ivanovci (red sv. Ivana Jeruzalemskog, *hospitalci*). Posljednji ivanovački preceptor Gore javlja se u dokumentima 1386. godine (Dobronić 2002: 219). Lelja Dobronić (2002: 215–216) navodi da

- 1 Ovaj je rad financirala Hrvatska zaklada za znanost projektom „milOrd – Razvoj i naslijeđe viteških redova u Hrvatskoj“ (HRZZ, IP-2019-04-5513).
- 2 Sakristija crkve Uznesenja Blažene Djevice Marije u Gori arheološki je istraživana tijekom 2010. i 2011. godine. Bio je to nastavak arheoloških istraživanja Instituta za arheologiju iz Zagreba pod vodstvom J. Belaja, pokrenutih radi cjelovite obnove u Domovinskom ratu razrušene crkve. Prethodne su kampanje provedene tijekom 2008. i 2009. godine kada je, za potrebe drenaže, istražen rov širine oko 1 m uokolo temelja templarske crkve te 24 m dug rov za odvodnju drenaže, koji se od crkve pruža u smjeru istoka (Belaj 2011; Belaj, Sirovica 2012). Ranija istraživanja Hrvatskog restauratorskog zavoda, pod vodstvom D. Miletića i M. Valjato Fabris, obuhvaćala su istraživanje zidova (1997.) i njihovu demontažu (1998.), ali i arheološka istraživanja dijelova svetišta (1998.) te pročelja templarske crkve i temelja nadogradnji iz XIX. stoljeća (2003.) (Miletić 1999; Azinović Bebek, Pleše 2004).
- 3 Među prvim poznatim templarskim posjedima na tlu srednjovjekovne Slavonije spominje se i do danas neubiciran predij Haco koji se nalazio u blizini Petrinje u gorskoj županiji; templarima ga je darovao župan Gore Gutitemer (Gutimir, Godimir?), a darovnicu je potvrdio kralj Stjepan III. ili Stjepan IV., svakako između 1162. i 1172. godine (Dobronić 2002: 29; Karbić, Karbić 2021: 69–70). Posjede u gorskoj županiji nastavili su dobivati i od kasnijih kraljeva, Emerika i Andrije II. Sam preceptorat Gora u sačuvanim ispravama prvi puta se spominje tek 1242. godine (Dobronić 2002: 86).

INTRODUCTION

The Church of the Assumption of the Blessed Virgin Mary¹ is situated in the village of Gora in the Banovina region, along one of the most important medieval roads that connected the center of the Croatian and Hungarian Kingdom in Pannonia to the Adriatic Sea (Map 1). Although this site is famous for its Templar church, its history started much earlier.² However, only scarce fragments of pottery testify of the period of prehistory and antiquity. Grave fills also revealed several samples of Prague-type pottery produced in the 7th and 8th century (Bekić 2016: 47, 48, Fig. 24; 285, T. 72: 1, 4, 7), during the Slavic migrations to the area of the Mura, Drava, and Sava rivers.

Remains of a semi-circular apse of a church built in the Romanesque period were discovered. Although no other wall foundations of the Romanesque church were found, probably because they were destroyed during the construction of the early Gothic Templar church, the orientation of the earliest graves indicates that it was oriented somewhat differently than the church from the later period. The earliest graves were oriented more in the northwest-southeast direction, i.e., with a deviation of around 18–19° compared to the orientation of the early Gothic church and the graves buried next to it.

Graves of the same orientation as the early Gothic church are from a somewhat later period and can be linked to the time when the Gora County estates were held by Knights Templar. The Knights Templar gained the estates gradually. The first known estate was acquired between 1162 and 1172.³ The year they gained the Romanesque church in Gora and the accompanying land is unknown, but we know that it was in their possession by the reign of Bela III (1172–1196). They soon built a new, “military order type” early Gothic church (Fig. 1) in its place from the ground up. Numerous fragments of the Romanesque church were built in as spolia in the foundations and walls of the early Gothic church (Miletić 1999: 144–145; Miletić, Valjato Fabris: 2014, 57).

- 1 This work has been supported by the Croatian Science Foundation under the project “milOrd – Development and Heritage of the Military Orders in Croatia” (HRZZ, IP-2019-04-5513).
- 2 Sacristy of the Church of the Assumption of the Blessed Virgin Mary in Gora was excavated during 2010 and 2011. It was the continuation of the archaeological excavation conducted by the Institute of Archaeology in Zagreb and led by J. Belaj. The excavation was prompted by the complete renovation of the church, which was destroyed during the Croatian War of Independence. Previous campaigns were conducted in 2008 and 2009. Two trenches used for drainage were excavated at the time; an about 1-meter-wide trench around the foundations of the Templar church and a 24 m long trench extending from the church to the east (Belaj 2011; Belaj, Sirovica 2012). Earlier excavations conducted by the Croatian Conservation Institute and led by D. Miletić and M. Valjato Fabris included the exploration (1997) and deconstruction (1998) of the walls, but also the excavation of a part of the sanctuary (1998) and the façade of the Templar church, as well as the foundations of the 19th century annexes (2003) (Miletić 1999; Azinović Bebek, Pleše 2004).
- 3 The first known Templar estates in the medieval Slavonia include the praedium of Haco situated near Petrinja in the Gora County, that still has not been located to this day. It was given to the Templars by Gutitemer (Gutimir, Godimir?), župan of the Gora County. The deed was confirmed by King Stephen III or Stephen IV, certainly between 1162 and 1172 (Dobronić 2002: 29; Karbić, Karbić 2021: 69–70). The estates in the Gora County were gifted to the Templars by other kings, Emerik and Andrew II, as well. The Gora preceptory was mentioned in the surviving documents for the first time only in 1242 (Dobronić 2002: 86).

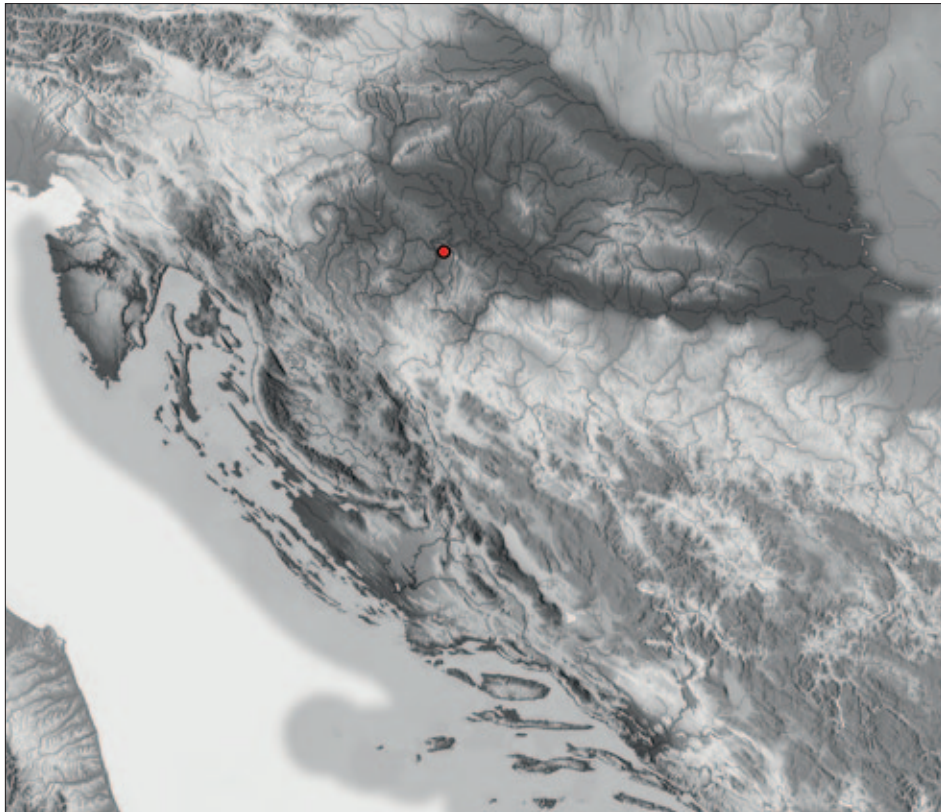

Karta 1 Položaj crkve Uznesenja Blažene Djevice Marije u Gori (izradio: J. Belaj)
Map 1 Position of the Church of the Assumption of the Blessed Virgin Mary in Gora (made by: J. Belaj)

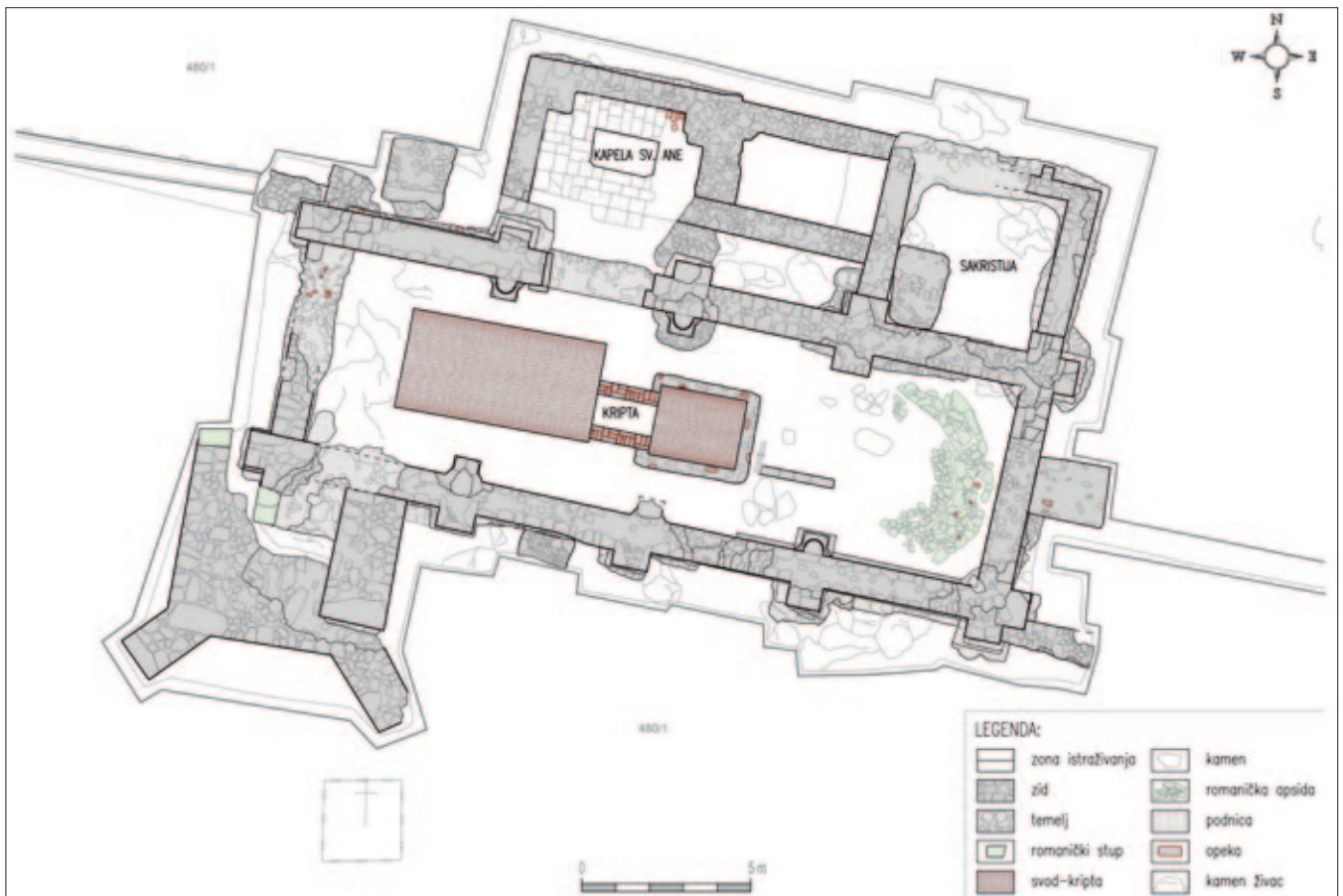

Sl. 1 Arhitektonski snimak tlocrta crkve Uznesenja Blažene Djevice Marije u Gori (izradio: A. Kovačević, Arheoplan d.o.o.)
Fig. 1 Architectural survey of the floorplan of the Church of the Assumption of the Blessed Virgin Mary in Gora (made by: A. Kovačević, Arheoplan Ltd.)

su ivanovci Goru napustili „zbog provale Turaka“ te je ona ušla u državnu imovinu, da bi je kralj Vladislav darovao biskupu Osvaldu 1495. godine. Početkom XVI. stoljeća, sve do svoje smrti 1512. godine, Gorom upravlja vranski prior Bartol Berislavić Grabarski. Nakon njegove smrti upravite- ljem dobara – ali ne i priorom – Vranskog priorata imeno- van je Petar Berislavić, koji je Goru podijelio knezu Mihaelu Frankopanu Slunjskom 1514. godine (Dobronić 2002: 215– 216). U doba najžešćih bojeva s Osmanlijama zagrebački je kaptol posjede u Gori dao na uživanje Frankopanima, koji su iz gorske utvrde⁴ ratovali (Cvitanović 1971: 151).

Tijekom osmanlijske vladavine, od 1592. pa sve do 1702. godine, u Gori se ne navodi župa. Štoviše, na poznatoj karti isusovca Stjepana Glavača iz 1673. gorska crkva označena je simbolom za naselje koje je nekada imalo župu (*parochia olim*).⁵ Oslobođenje od Osmanlija crkva je vjerojatno dočekala u ruševnom stanju. Drago Miletić (1999: 136) na- vodi da je bila zapaljena te da su zidovi čitavo stoljeće bili izloženi atmosferijama. Iz protokola kanonskih vizitacija doznaje se da joj je po ponovnom osnutku župe, u sklopu hitne obnove, prizidana i nova sakristija (vizitacija iz 1705. godine), a prava barokizacija odvijala se od 1726. do 1736. godine (Cvitanović 1971: 151; Miletić 1999: 146–147).

FAZE UKOPAVANJA NA PROSTORU SAKRISTIJE

Tijekom arheološkog iskopavanja istraženo je ukupno 426 grobova koji se na širem prostoru oko crkve ukopavaju vjerojatno već od početka XI. pa sve do kraja XVIII. stolje- ća.⁶ Studija navedena u naslovu provedena je na temelju podataka prikupljenih tijekom istraživanja izvedenih na području sakristije. Naime, iskopavanje je većinom prove- dено na uskom prostoru uokolo temelja crkve što je one- mogućilo cjelovito istraživanje pojedinih grobova i time umanjilo mogućnost potpunog definiranja kompleksnih stratigrafskih odnosa kakvi karakteriziraju ovakve tipove arheoloških nalazišta. Utoliko su podaci iz sakristije oda- brani za temeljnu analizu stratigrafskog slijeda jer su pri- kupljeni na prostorno zaokruženoj cjelini na kojoj je bilo moguće dobro utvrditi faze ukopavanja grobova.

Tijekom istraživanja sakristije utvrđena su 53 groba koja su na ovom prostoru ukopana prije njezine izgradnje. Osteološki ostaci *in situ* utvrđeni su u 49 grobova,⁷ dok su

After the Order of the Knights Templar was dissolved in 1312, the church, together with other Templar estates in Croatia, was inherited by the Hospitallers (Order of Knights of the Hospital of Saint John of Jerusalem, Knights Hospitaller). The last Hospitaller preceptor of Gora was mentioned in the documents from 1386 (Dobronić 2002: 219). Lelja Dobronić (2002: 215–216) states that the Knights Hospitaller left Gora “because of Ottoman invasion”. Gora consequently became state property and King Vladisla- us gifted it in 1495 to Bishop Osvald. At the beginning of the 16th century and until he died in 1512, Bartol Berislavić of Grabarje, the prior of Vrana, controlled Gora. After his death, Petar Berislavić was named the procurator of the Priory of Vrana, but not the prior. He granted Gora to the Duke Michael Frankopan of Slunj in 1514. (Dobronić 2002: 215–216). During the fiercest battles with the Ottomans, the chapter in Zagreb gifted the estates in Gora to the Frankopan family who used the Fort of Gora⁴ for war pur- poses (Cvitanović 1971: 151).

During the Ottoman rule, from 1592 to 1702, there are no records of a parish in Gora. Moreover, on the well- known 1673 map of Jesuit Stjepan Glavač, the church is marked with the symbol for a settlement that used to have a parish in the past (*parochia olim*).⁵ At the time it was reconquered from the Ottomans, the church was proba- bly dilapidated. Drago Miletić (1999: 136) states that it was even set on fire and the walls were exposed to the weather for a whole century. The canonical visitation records reveal that, as part of an urgent reconstruction, a new sacristy was constructed in the church (1705 visitation) when the parish was re-established, while a true reconstruction in the Baroque style took place between 1726 and 1736 (Cvi- tanović 1971: 151; Miletić 1999: 146–147).

BURIAL PHASES IN THE SACRISTY

During the archaeological excavation, 426 graves al- together were unearthed. They were buried around the church probably from the beginning of the 11th to the end of the 18th century.⁶ The study from the article’s title was conducted on the data gathered during the excavation conducted in the area of sacristy. Most of the excavation was conducted in a narrow area around the church founda- tions which prevented excavation of most graves in their entirety and made it difficult to clearly define the complex stratigraphy that characterizes archaeological sites such as this one. Therefore, the data from the sacristy was chosen for a thorough analysis of stratigraphic sequence because it was collected in an enclosed area where it was possible to determine burial phases with certainty.

4 Stari gorski grad nalazio se na brežuljku oko 900 m sjevernije od crkve.

5 Crkva nije označena ni na jozefinskom zemljovidu nastalom tijekom tzv. prve vojne izmjere (1773. – 1775.), dok, primjerice, crkva sv. Pavla i Stari grad jesu (<https://maps.arcanum.com/en/map/europe-18century-firstsurvey/?layers=163%2C165&bbox=1799492.5903202405%2C5685906.268936899%2C1807198.39823424%2C5689379.376409607>; 30. 12. 2020).

6 Uz pojedine nalaze iz najmlađih istraženih grobova, o vremenu prestanka ukopavanja na crkvenom groblju svjedoči i Spomenica župe Gora na temelju koje Đurđica Cvitanović (1971: 154, bilj. 17) navodi da je prvi ukop na novom groblju izvršen 1789. godine (v. i Miletić 1999: 146, bilj. 83).

7 Na prikupljenom ljudskom osteološkom materijalu provedena je bioarheološka analiza, rezultati koje će biti prikazani u radu naslovljenom „Bioarheološka studija populacije iz Gore kraj Petrinje, Hrvatska“ (Bedić et al. 2022). U tom se radu prikupljeni podaci razmatraju u odnosu na ovdje utvrđene faze pokopavanja. U ovom radu korišteni podaci dobiveni bioarheološkom analizom odnose se većinom na dob i spol pokojnika.

4 The Old Town of Gora was situated on a hill around 900 m north of the church.

5 The church was also not marked on the map from the time of Joseph II created during the First Military Survey (1773–1775), while, for ex- ample, St. Paul’s Church and the Old Town were (<https://maps.arcanum.com/en/map/europe-18century-firstsurvey/?layers=163%2C165&bbox=1799492.5903202405%2C5685906.268936899%2C1807198.39823424%2C5689379.376409607>; December 30, 2020).

6 Alongside several finds from the most recent graves, Gora Parish Memorial also testifies to the time of the cessation of burial in the church cemetery. Based on the Memorial, Đurđica Cvitanović (1971: 154, n. 17) states that the first burial on the new cemetery was conducted in 1789 (see Miletić 1999: 146, n. 83).

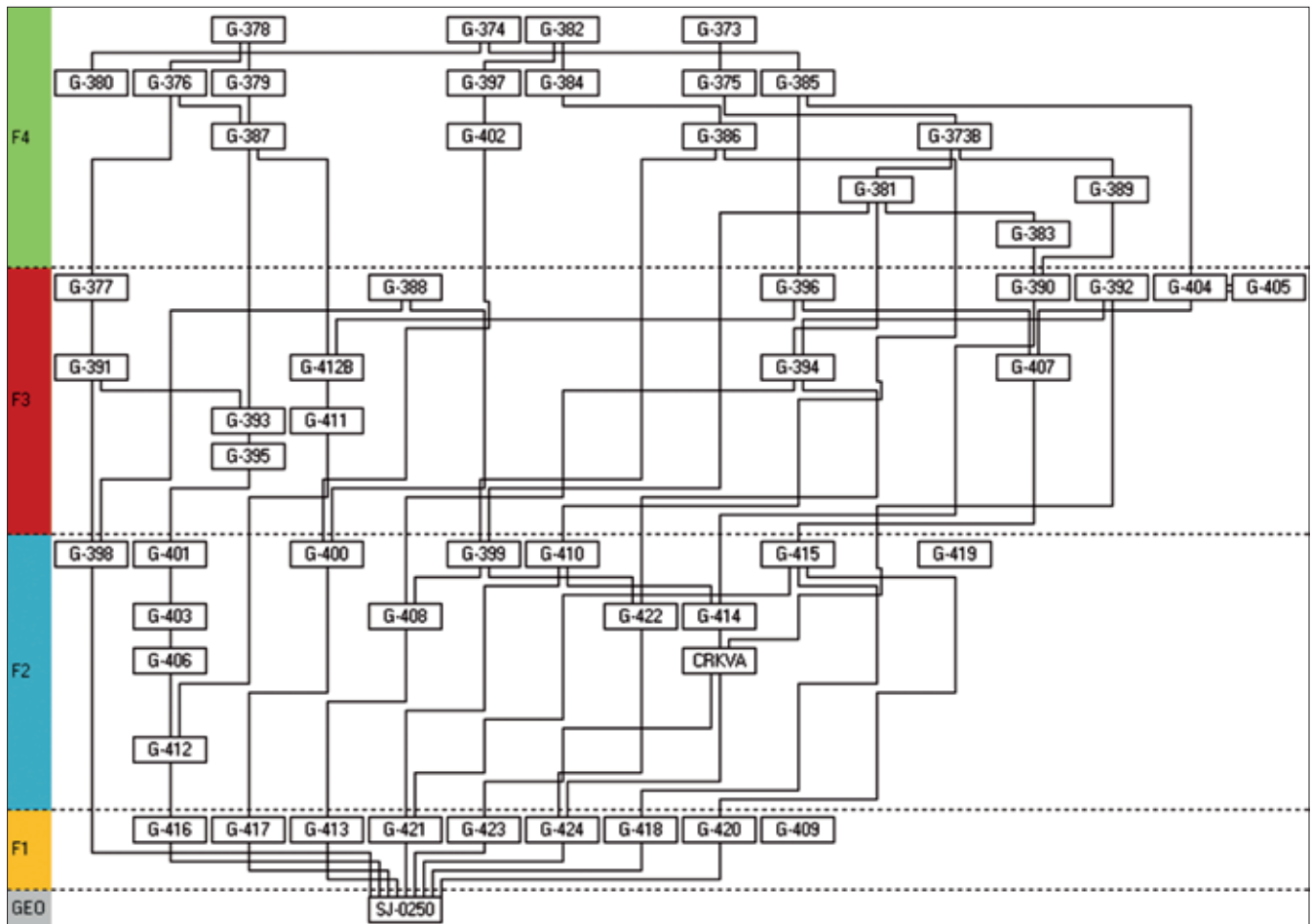

Sl. 2 Dijagram s prikazom stratigrafskih odnosa grobova istraženih na prostoru kasnije sagrađene sakristije (izradila: F. Sirovica; softver: Stratify 1.5, © Irmela Herzog)

Fig. 2 Diagram showing the stratigraphic relations of the graves excavated in the area where the sacristy was later built (made by: F. Sirovica, software: Stratify 1.5, © Irmela Herzog)

preostala četiri presječena mlađim ukopima i sadržavala su samo kosturnice, odnosno kosti iz starijih presječenih grobova, sekundarno deponirane uz rubove mlađih grobnih ukopa. U svim grobovima sa sačuvanim kosturima pokojnici su bili položeni na leđa s glavom na zapadnoj strani i ispruženih nogu, no uz varijacije u položaju ruku, orijentaciji ukopa i prisutnim arheološkim ostacima.⁸ Obilježja grobnih cjelina, poput njihove orijentacije, prisutnosti većeg kamena u grobovima, pougljenjenog drveta i čavala te položaja ruku pokojnika, zajedno s rezultatima analize stratigrafskog slijeda (sl. 2), pokretnog arheološkog materijala i radiokarbonskih datuma (tab. 1),⁹

Fifty-three graves were discovered during the excavation in the sacristy; they were buried in this area before the sacristy was built. Osteological remains *in situ* were discovered in 49 graves,⁷ while four other graves were cut by later graves and included only reburied remains, i.e. bones from earlier truncated graves which were consequently deposited along the edges of later graves. All graves with preserved skeletons included deceased individuals placed on their backs with their heads pointing to the west and their legs extended, but the position of their arms, orientation of the graves, and surviving archaeological remains varied.⁸ Grave units characteristics, such as their orientati-

8 U svim fazama ukopavanja grobovi male djece, posebno dojenčadi i fetusa, najčešće nisu precizno orijentirani ili su premali i nedovoljno očuvani da bi granice njihovih ukopa bile precizno definirane. Dodatno, zbog loše očuvanosti kostiju ili učestale narušenosti njihovog rasporeda, u tim grobovima najčešće nije bilo moguće utvrditi točan položaj tijela pri pokopu. Iz tog se razloga, ako nije drugačije navedeno, izneseni podaci o orijentaciji ukopa te utvrđenom položaju ruku odnose na grobove odraslih osoba te starije djece i adolescenata.

9 Do sada je radiokarbonska analiza provedena na 14 uzoraka kostiju iz grobova ukopanih na čitavom istraživanom području, od čega ih je šest s područja sakristije, a svi uzorci analizirani su u HEKAL AMS Laboratory, Debrecen, Mađarska (Isotopech-Atomki). Izvješće (Molnár 2020) nije objavljeno i čuva se u Institutu za arheologiju.

7 Bioarchaeological analysis was conducted on the collected human osteological material. The results will be presented in the paper titled, "Bioarheološka studija populacije iz Gore kraj Petrinje, Hrvatska" (Bioarchaeological study of the population of Gora near Petrinja, Croatia) (Bedić et al. 2022). The paper compares the collected data with the burial phases ascertained here. The data acquired in the bioarchaeological analysis used in this paper mostly concerns the age and the sex of the deceased.

8 In all phases, graves of little children, infants, and fetuses especially, were typically not precisely oriented or are too small and too poorly preserved for their confines to be precisely defined. Also, due to the poor degree of bone preservation or due to bone disruption, it was usually not possible to determine the exact position of the body in those graves. Therefore, unless stated otherwise, the presented data on the burial orientation and the recorded position of the arms refer to graves of adult individuals, older children, and adolescents.

Grob / Grave	Faza / Phase	Laboratorijska oznaka / Lab ID	Vrsta uzorka / Sample material	Konvencionalni datumi / Conventional age (BP)	Kalibrirani kalendarski datumi / Calibrated calendar age (AD)	
					68,2%	95,4%
60	1	DeA-28495	kost/bone	1034 ± 23	994–1023	979–1035
61	1	DeA-28496	kost/bone	999 ± 23	995–1116	994–1151
417	1	DeA-28506	kost/bone	957 ± 21	1035–1150	1030–1157
50	2	DeA-28491	kost/bone	910 ± 26	1048–1201	1041–1213
399	2	DeA-28504	kost/bone	844 ± 21	1176–1226	1165–1260
408	2	DeA-28505	kost/bone	880 ± 21	1163–1213	1053–1220
390	3	DeA-28503	kost/bone	292 ± 19	1525–1646	1520–1653
76	4	DeA-28497	kost/bone	392 ± 26	1451–1611	1444–1622
225	4	DeA-28499	kost/bone	413 ± 22	1447–1474	1437–1616
373	4	DeA-28501	kost/bone	343 ± 23	1493–1631	1475–1636
386	4	DeA-28502	kost/bone	298 ± 19	1525–1643	1514–1649

Tab. 1 Radiokarbonski datumi dobiveni na uzorcima iz pojedinih grobova koji se spominju u tekstu (izradili: J. Belaj, F. Sirovica, Ž. Bedić; prema: Molnár 2020)

Tab. 1 Radiocarbon dates obtained on samples from the graves mentioned in the text (made by: J. Belaj, F. Sirovica, Ž. Bedić; after: Molnár 2020)

smještaju istražene grobove u četiri faze ukopavanja (tab. 2).¹⁰

Faza 1

Grobovi prve faze u pravilu su ukopani u arheološki sterilnu geološku podlogu, obično nešto dublje od mlađih grobova. Orijentirani su u smjeru sjever/sjeverozapad–istok/jugoistok s odklonom od oko 18 – 19° u odnosu na orijentaciju ranogotičke crkve, odnosno oko 30° od pravca zapad–istok. Da je riječ o grobovima starijim od gotičke crkve svjedoči i to što su neki od njih presječeni velikim ukopima za zidove gotičke crkve. U prvu fazu ponajprije su ubrojena tri groba odraslih osoba (413, 417, 418) te tri dječja groba (416, 423, 424). Iste fazi vjerojatno pripadaju i tri groba odraslih osoba (409, 420, 421) koji svojim položajem prate utvrđeni smjer pružanja te poštuju raspored ukopa drugih grobova ove faze (sl. 3). Međutim, u sva tri nađene su uz rub rake kosti starijih pokojnika koje mogu upućivati na pripadnost ovih grobova idućoj fazi. U najstarijim grobovima pokojnici su položeni na leđa s rukama uz tijelo, a uz neke su nađeni ostaci pougljenjenog drveta, možda od lijesa. U jednom grobu (417) ustanovljen je veći

on, presence of larger stones in the graves, charred wood and nails, the position of the arms of the deceased individuals, as well as the results of the analysis of stratigraphic sequence (Fig. 2), movable archaeological material, and radiocarbon dates (Tab. 1)⁹, place the excavated graves into four burial phases (Tab. 2).¹⁰

Phase 1

Graves belonging to the first phase were typically buried in the archaeologically sterile geological subsoil, somewhat deeper than the later graves. They were oriented in the direction of north/northwest–east/southeast, deviating around 18–19° from the orientation of the early Gothic church, i.e., around 30° from the west–east direction. These graves are older than the Gothic church, which is confirmed by some of them being cut by large truncations of the walls of the Gothic church. The first phase primarily includes three graves of adult individuals (413, 417, 418) and three graves of subadults (416, 423, 424). Three graves

¹⁰ Na širem prostoru oko crkve istraživanjem je definirana i najmlađa, peta faza ukopavanja koja je trajala sve do kraja XVIII. stoljeća, a koja na području sakristije nije utvrđena.

⁹ Thus far, the radiocarbon dating was conducted on 14 human skeletal samples from graves buried across the whole excavated area; six of them from the sacristy. All samples were analysed in the HEKAL AMS Laboratory, Debrecen, Hungary (Isotopech-Atomki). The report (Molnár 2020) is not published. It is kept in the Institute of Archaeology.

¹⁰ The latest, fifth phase of burials that lasted up until the end of the 18th century was ascertained in the wider area around the church, but it was not discovered in the sacristy area.

Grob / Grave	Faza / Phase	Spol / Sex	Lijes / Coffin	Kamen / Stone	Ruke / Hands	Nalazi - pokojnik / Finds - deceased	Nalazi - zapuna / Finds - backfill
409	1	MP					KP
413	1	FP					KP
416	1	S		1 K-A	=	1 PR	
417	1	F	T	1 K-W	=	7 S-KR	KP
418	1	MP					
420	1	M	T	2 K-E	=		
421	1	F	T	3 K-W	=	1 S-KR, 1 KR, 1 PR	
423	1	S	T	1 K-A	=	8 S-KR,	
424	1	S					
408	2A	F	T	1 K-W, 1 K-A	=		S-KR, KP
412	2A	M			=		
419	2A	MP					
422	2A	S					
398	2B	R					
399	2B	S		1 K-N, 2 K-S	=	1 KO, 1 OK	
400	2B	R					
401	2B	M		2 K-N,		1 PR, 2 KO	
403	2B	F			=	1 KO	KP
406	2B	M	T				
410	2B	FP			=		OP
414	2B	M, MP	T	2 K-N, 2 K-S	=, =		
415	2B	MP	T	1 K-N, 5 K-S	=		KP, OP
377	3	M			=?	1 KN	KP
388	3	F	T, N		=		KP
390	3	M		1 K-N, 1 K-S	=		
391	3	S	T, N		=?	1 AP	KP, ZG
393	3	M	T		=		
395	3	S				1 PL	KP
396	3	F	N		=?		
404	3	S			=		KP, ZG
407	3	M					
411	3	U					
412B	3	R					
373	4	S			+	1 KO, 1 NC	ZG
373B	4	R					NC
374	4	F	T, N		+		KP
375	4	S					ST
376	4	M	N		+	1 NC	KP, ZG, ST
378	4	S	N		+		KP, ZG
379	4	M	T, N		+		NC, KP, ZG
380	4	S	T, N			2 AP	KO
381	4	M			+		
382	4	M			+	1 KO	KP
383	4	FP					
384	4	S			+		
385	4	S	T, N		=		KP
386	4	M			+	1 KO	
387	4	F	N		+		ZG
389	4	S					
392	4	S					
394	4	S					
397	4	S					
402	4	S					

Tab. 2 Podaci o grobovima istraženim na prostoru sakristije prema fazama ukopavanja. Korištene kratice: S – dijete, F – žena, M – muškarac, FP – vjerojatno žena, MP – vjerojatno muškarac, R – kosturnica; T – tragovi pougljenjenog drveta, N – čavli; K – kamen, A – ruka, N – sjever, S – jug, E – istok, W – zapad; (=) – ispružene ruke, (+) – prekrizene ruke; PR – prsten, S-KR – S-karičica, KR – karičica, KO – kopča, OK – okov, KN – nož; AP – aplikacija, PL – pločica, NC – novac; KP – keramika, OP – opeka, ZG – zgura, NC – novac, ST – staklo (izradili: J. Belaj, F. Sirovica, Ž. Bedić)

Tab. 2 Data about the graves excavated in the sacristy area divided into burial phases. Abbreviations: S – child, F – female, M – male, FP – probably female, MP – probably male, R – reburied remains; T – charred wood traces, N – nails; K – stone, A – arm, N – north, S – south, E – east, W – west; (=) – extended arms, (+) – crossed arms; PR – ring, S-KR – S-cirlet, KR – cirlet, KO – buckle, OK – loop, KN – knife; AP – mount, PL – plate, NC – coin; KP – pottery, OP – brick, ZG – slag, NC – coin, ST – glass (made by: J. Belaj, F. Sirovica, Ž. Bedić)

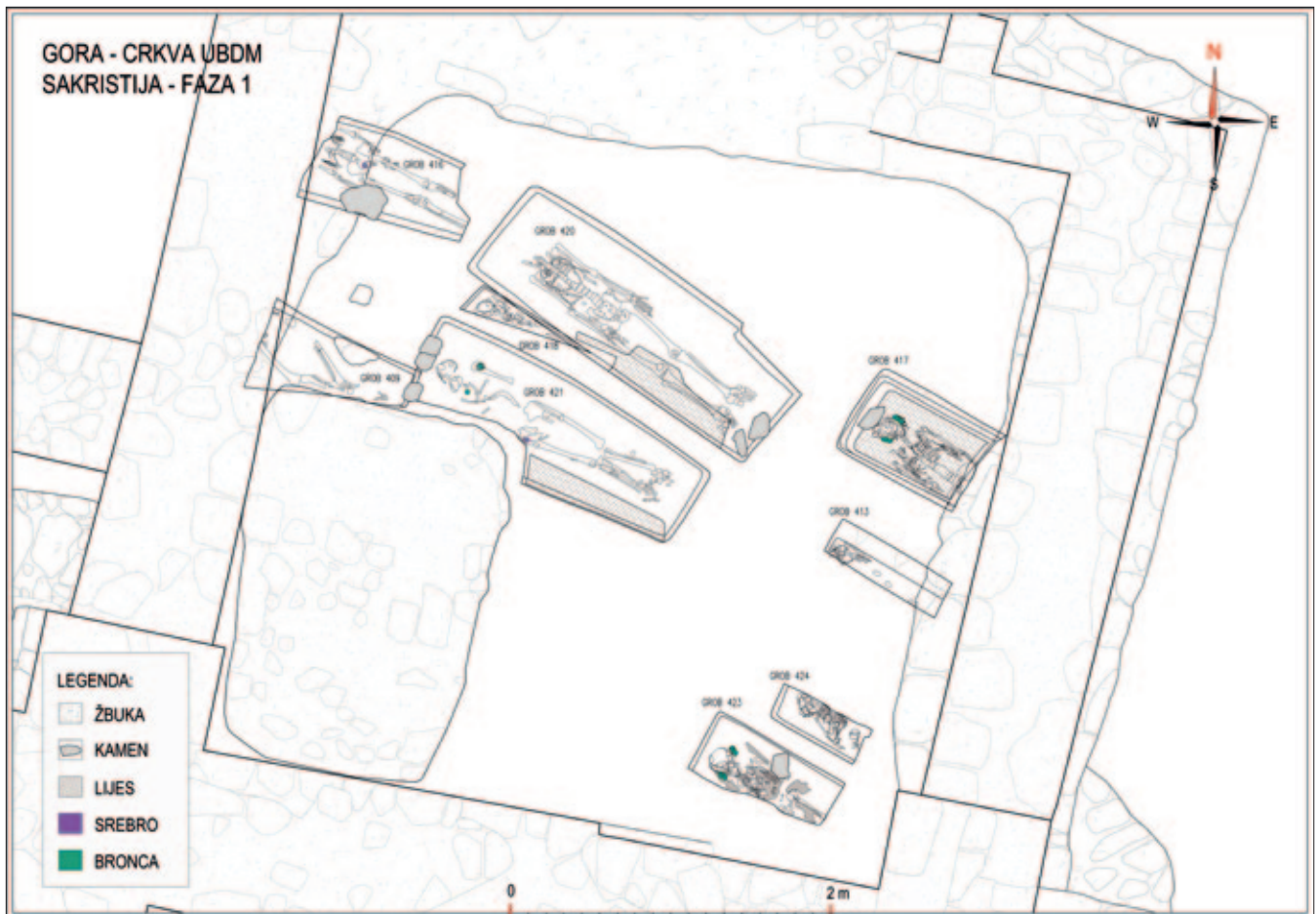

Sl. 3 Grobovi pripisani prvoj fazi ukopavanja (izradili: F. Sirovica, A. Kovačević, Arheoplan d.o.o.)

Fig. 3 Graves assigned to the first burial phase (made by: F. Sirovica, A. Kovačević, Arheoplan Ltd.)

kamen nađen uz tjeme pokojnice, dok su u dvama grobovima (420, 421) utvrđena tri kamena uz tjeme, odnosno dva uz noge pokojnika. Običaj postavljanja kamena uz glavu pokojnika ili oblaganja grobnih raka kamenjem zabilježen je na mnogim grobljima ranog i razvijenog srednjeg vijeka (vidi detaljnije u Belaj, Sirovica 2016; 2021), ali i novog vijeka (Demo 2013). Dodatna specifičnost gorskih ukopa, dokumentirana u dva groba prve faze ukopavanja (416, 423), pojava je većeg kamena u predjelu iznad ruke pokojnika. Iako nije moguće tvrditi da je riječ o rezultatu namjernog postupka, slična će praksa biti zabilježena i u slijedećoj fazi ukopavanja. Kako su u jednom uočeni ostaci pougljenjenog drveta, dok su u drugom potamnjele kosti možda rezultat raspada drveta, moguće da je kamenje izvorno i s namjerom postavljeno iznad lijesa.

Prva faza pokopavanja obilježena je pojavom nalaza tzv. bjelobrdske kulture,¹¹ ponajprije S-karičica zabilježenih u tri groba te prstenjem u dvama grobovima. Među nalazima iz ovih grobova ističe se osam velikih brončanih S-karičica¹² nađenih u grobu 423 (sl. 4: A) te njih sedam¹³

of adult individuals (409, 420, 421) probably also belong to this phase. They are aligned with the ascertained orientation and placed with consideration towards burial layout of the graves from this phase (Fig. 3). However, reburied bones of previously deceased individuals were discovered along the edges of all three graves, which could indicate that these graves belong to the next phase. Deceased individuals in the earliest graves were placed on their backs with their arms extended along the body. Remains of charred wood, perhaps from the coffin, were discovered next to some of them. A larger stone was discovered next to the deceased woman's scalp in one grave (417), while three stones were discovered next to the scalp and two next to the legs of the deceased individuals in two graves (420, 421). The practice of placing stones next to the heads of the deceased or lining the graves with stones was recorded in many cemeteries from the Early and High Middle Ages (c.f. Belaj, Sirovica 2016; 2021), but also in the early modern period (Demo 2013). Additional characteristics of Gora burials are larger stones occurring in the area above the deceased individuals' arms, documented in two graves from the first burial phase (416, 423). Although we cannot claim that the stones were placed there intentionally, a similar phenomenon was recorded in the following burial phase as well. Since the remains of charred wood were recorded in one grave and darkened bones that might have

11 Kolegama Anamariji Špek i Sebastijanu Stinglu zahvaljujemo na obradi i pobližem određivanju nalaza.

12 Promjer karičica iznosi 26,6 do 31 mm, debljina žice 1,2 do 1,5 mm.

13 Promjer karičica iznosi 48,8 do 61 mm, debljina žice 1,8 do 2,3 mm.

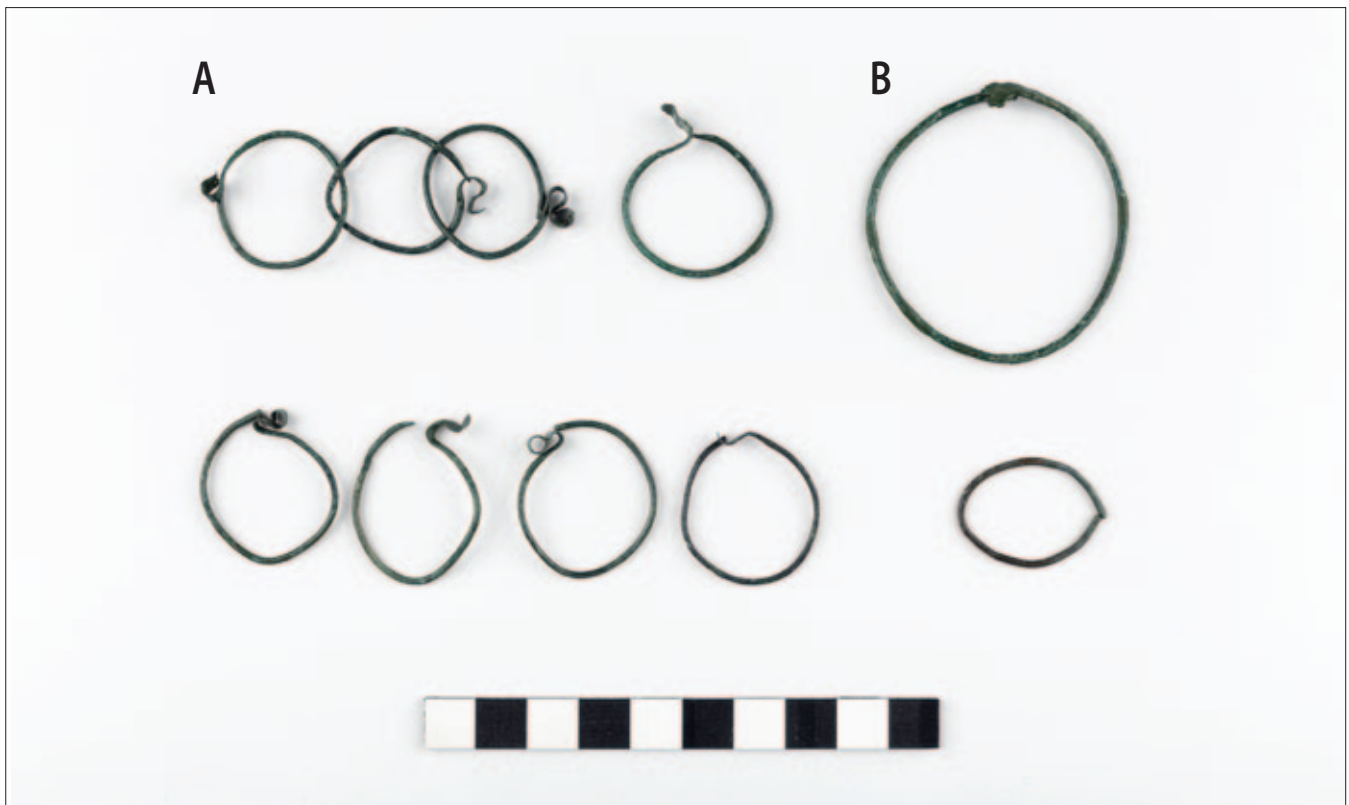

Sl. 4 A) Osam velikih brončanih S-karičica nađenih u grobu 423; B) krupna S-karičica i velikoformatna ovalno savijena brončana karičica ravno podrezanih i priljubljenih krajeva iz groba 421 (snimio: Janko Belaj)

Fig. 4 A) Eight large bronze S-circlets discovered in grave 423; B) Bulky S-circlet and large-format oval bronze circlet with straight-cut endings pressed onto one other from grave 421 (photo by: Janko Belaj)

iz groba 417 koji je radiokarbonskom analizom datiran između 1030. i 1157. godine. Analogne S-karičice, osobito po svojem izrazito velikom formatu,¹⁴ nađene su u Stenjevcu, primjerice u grobu 47 (Simoni 2004: 25, kat. 10, 1–5) ili pak grobu 74 (Simoni 2004: 28, kat. 15, 1–6), na groblju koje traje tijekom XI. i XII., a možda još i XIII. stoljeća (Simoni 2004: 58), u Šćitarjevu, oko crkve sv. Martina, datirane u XII. i XIII. stoljeće (Knezović, Pintarić 2006: 11, 22, kat. br. 86), u Ivanu u grobu 25, smještenom u četvrtu fazu ukopavanja datiranu od XI. do sredine XIII. stoljeća (Krznar 2012: 97, 119) te u Đakovu kod župne crkve, u grobu 348 koji je smješten u II. fazu pokapanja, odnosno između početka XII. i sredine XIII. stoljeća (Filipec 2012: 79, 213, 316, T. 51, 3–5).¹⁵

Krupna¹⁶ brončana S-karičica nađena je i iznad ramena pokojnice iz groba 421, dok je ispod njenoga vrata nađena velikoformatna ovalno savijena brončana karičica ravno podrezanih i priljubljenih krajeva (sl. 4: B).¹⁷ Gotovo identičan primjerak nađen je na groblju u Mačvanskoj Mitrovici, u grobu 61, također zajedno sa S-karičicom. Taj grob pripisan je najstarijoj fazi groblja te se pretpostavlja da je stariji od crkve iz XI. stoljeća (Ercegović-Pavlović 1980: 21, 42, T.

been the result of the decay of wood in another, it is possible that the stones were placed above the coffin originally and intentionally.

The first burial phase was marked by the finds from the so-called Bijelo Brdo culture,¹¹ especially by the finds of S-circlets, which were recorded in three graves, and rings, in two graves. Eight large bronze S-circlets¹² discovered in grave 423 (Fig. 4: A) stand out among the finds from these graves, together with seven circlets¹³ from grave 417 dated by the radiocarbon analysis between 1030 and 1157. Analogous S-circlets, especially in their large format,¹⁴ were discovered in Stenjevec in grave 47 (Simoni 2004: 25, cat. 10, 1–5) and grave 74 (Simoni 2004: 28, cat. 15, 1–6), at the cemetery that was used during the 11th and 12th, and maybe even during the 13th century (Simoni 2004: 58), in Šćitarjevo, around St. Martin's Church, dated to the 12th and 13th century (Knezović, Pintarić 2006: 11, 22, cat. no. 86), in Ivanec in grave 25 identified as belonging to the fourth burial phase dated from the 11th to the mid-13th century (Krznar 2012: 97, 119), and in Đakovo, near the parish church, in grave 348 from the second burial phase, i.e., between the

14 Općenito o S-karičicama, posebno o razlici između onih velikog i malog formata, v. u Demo 2014: 72; Filipec 2012: 114–115.

15 Kod župne crkve u Đakovu S-karičica sličnog formata, ali željezna, nađena je u grobu 83 koji se smješta u prethodnu, I. fazu groblja, datiranu od IX./X. do početka XII. stoljeća (Filipec 2012: 49, 211, 279, T. 14: 1).

16 Promjer karičice iznosi 51,8 do 55,4 mm, debljina žice je oko 1,9 mm.

17 Promjer karičice iznosi 21,5 do 29,4 mm, debljina žice je oko 1,5 mm.

11 We would like to thank our colleagues Anamarija Špek and Sebastijan Stingl for the analysis and closer determination of the finds.

12 The diameter of the circlets is 26.6 to 31 mm; the thickness of the wire is 1.2 to 1.5 mm.

13 The diameter of the circlets is 48.8 to 61 mm; the thickness of the wire is 1.8 to 2.3 mm.

14 For general information about S-circlets, especially about the difference between the large and small ones, see Demo 2014: 72; Filipec 2012: 114–115.

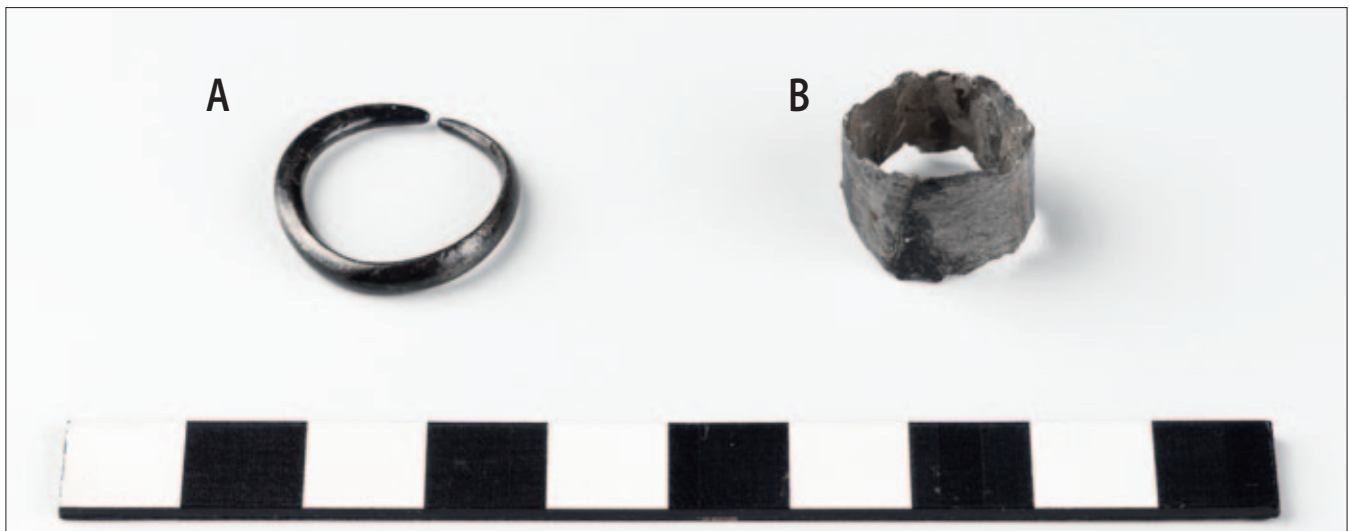

Sl. 5 A) Prsten suženih i razdvojenih krajeva obruča iz groba 421; B) trakasti prsten iz groba 416 (snimio: Janko Belaj)
 Fig. 5 A) Ring with narrowed and separated endings of the hoop from grave 421; B) Band-shaped ring from grave 416 (photo by: Janko Belaj)

Pl. XX: tombe 61). Slični primjerci, promjera oko 30 mm, ponovo su nađeni u Stenjevcu, u grobovima 23 i 24 (Simoni 2004: 23, kat. 3, 4)¹⁸ te na lokalitetu Vukovar – Lijeva bara (Demo 2009: 438–444). Prema Željku Demi to su karičice bez nastavka (Demo 2009: 440–444, sl. 25: 1.1b.1), i datiraju se u X. stoljeće, premda mogu trajati i do kraja četvrtog desetljeća XI. stoljeća kada pokapanje na lokalitetu Vukovar – Lijeva bara prestaje (Demo 2009: 553, bilj. 9).

Pokojnica iz groba 421 na desnoj je ruci imala i jednostavan srebrni prsten, suženih i razdvojenih krajeva obruča romboidnog presjeka (sl. 5: A),¹⁹ koji pripada vrlo rasprostranjenoj grupi prstenja u Karpatskoj kotlini, osobito čestoj u prvoj polovici XI. stoljeća (v. npr. Giesler 1981: Taf. 4: 27, Taf. 53; Tomičić 1990: 88–89; Simoni 2004: 47, kat. 41, 6; Gáll 2013: 885–886, Pl. 312: 2a; Bojčić 2015: 31, kat. 6.9). Prsten je pronađen i u grobu 416 (sl. 5: B).²⁰ Riječ je o trakastom zatvorenom prstenu izrađenom od tankog srebrnog lima, a rubovi su mu toliko neuredni da se čini kao da je riječ o nezavršenom proizvodu.²¹

Vrlo vjerojatno je i pokojnica iz groba 413 bila pokopana sa srebrnim S-karičicama, no one nisu ostale *in situ*, već su im fragmenti nađeni u zapuni groba pripisanog idućoj fazi ukopavanja (408), čijim je ukopom ovaj bio presječen.²² **Analize pojedinih obilježja grobnih cjelina i prisutnih na-**

beginning of the 12th and mid-13th century (Filipec 2012: 79, 213, 316, T. 51, 3–5).¹⁵

A bulky¹⁶ bronze S-circllet was discovered above the shoulder of the deceased woman from grave 421, while a large-format oval bronze circllet with straight-cut endings pressed one onto the other (Fig. 4: B)¹⁷ was discovered under her neck. An almost identical circllet was discovered at the cemetery in Mačvanska Mitrovica in grave 61, alongside an S-circllet. That grave was assigned to the earliest phase of the cemetery and is assumed to be older than the 11th-century church (Ercegović-Pavlović 1980: 21, 42, T. Pl. XX: tombe 61). Similar circllets, around 30 mm in diameter, were discovered in Stenjevec in graves 23 and 24 (Simoni 2004: 23, cat. 3, 4)¹⁸ and at the site of Vukovar – Lijeva bara (Demo 2009: 438–444). According to Željko Demo, those circllets have no sequel links (Demo 2009: 440–444, Fig. 25: 1.1b.1), and are dated to the 10th century, although they can be found until the cessation of burials at the site of Vukovar – Lijeva at the end of the fourth decade of the 11th century (Demo 2009: 553, note 9).

The deceased woman from grave 421 had a simple silver ring on her right hand as well. The ring's hoop was narrowed, had separated endings, and a rhomboid cross-section (Fig. 5: A).¹⁹ It belongs to the type of rings that were

18 Katica Simoni (2004: 23, kat. 3, 4) ih je pripisala Gieslerovom Tipu 25, no prema njegovoj tipologiji to je u stvari prsten, a ne karičica (Giesler 1981: 109–113, Taf. 4.25). Jochen Giesler (1981) u svojoj tipologiji ne navodi ovakve karičice.

19 Prsten je promjera 21,2 do 22 mm. Presjek prstena je romboidan, pri čemu je vanjska ploha zaobljena, a hrbat je s unutarnje strane. Najveća debljina prstena iznosi oko 2,5/3,3 mm, dok je pri kraju krakova oko 1,15/1,5 mm.

20 Prsten je promjera 15 do 16,2 mm, obruč je širok 4,2–12,1 mm, debljine 0,5 do 0,7 mm.

21 U bjelobrdskoj građi zastupljeno je trakasto prstenje, no najčešće rastavljene i preklapljene krajeve te s površinom ukrašenom jednostavnim urezima (Demo 2009: 506–507, Fig. 43: 1.2a–1.2b).

22 Promjer najbolje sačuvane karičice vjerojatno je iznosio 39 do 47 mm, debljina žice je oko 2 mm.

15 Near the parish church in Đakovo, an S-circllet of a similar size, but made of iron, was discovered in grave 83 thought to originate from the previous, first phase of the cemetery, dated from the 9th/10th to the beginning of the 12th century (Filipec 2012: 49, 211, 279, T. 14, 1).

16 The diameter of the circllet is 51.8 to 55.4 mm; the thickness of the wire is around 1.9 mm.

17 The diameter of the circllet is 21.5 to 29.4 mm; the thickness of the wire is around 1.5 mm.

18 Katica Simoni (2004: 23, cat. 3, 4) assigned them to type 25 proposed by Giesler, but according to his typology, this is actually a ring, not a circllet (Giesler 1981: 109–113, Taf. 4.25). In his typology, Jochen Giesler (1981) does not mention circllets like these.

19 The diameter of the ring is 21.2 to 22 mm. The ring has a rhomboid cross-section, the outer wall is curved, and the ridge of the ring is on the inside. The thickest part of the ring is 2.5/3.3 mm, while at the endings the thickness is around 1.15/1.5 mm.

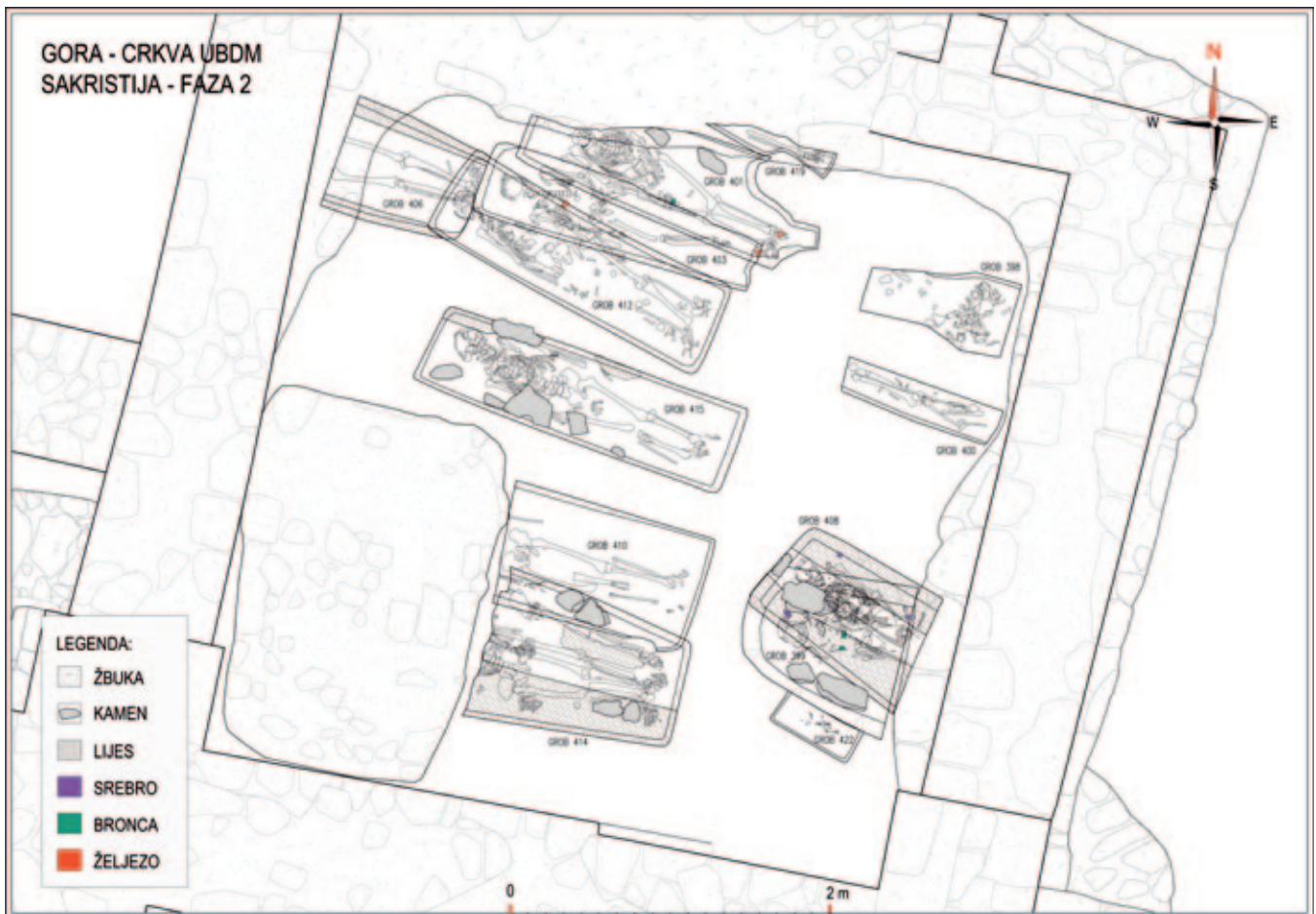

Sl. 6 Grobovi pripisani drugoj fazi ukopavanja (izradili: F. Sirovica, A. Kovačević, Arheoplan d.o.o.)
 Fig. 6 Graves assigned to the second burial phase (made by: F. Sirovica, A. Kovačević, Arheoplan Ltd.)

laza početak ukopavanja na ovom prostoru smještaju u početak XI. stoljeća. To potvrđuje i radiokarbonski datum dobiven na uzorku iz groba 417, kao i pojedini datumi dobiveni na uzorcima iz grobova ukopanih izvan sakristije (60, 61) koji čak otvaraju mogućnost da je ukopavanje počelo i nešto ranije. S druge strane, trajanje prve faze ukopavanja grobova moguće je pratiti sve do dolaska templara tijekom druge polovice XII. stoljeća.

Faza 2

Trinaest grobova u kojima su pokojnici i dalje položeni s rukama uz tijelo pripisano je drugoj fazi ukopavanja (sl. 6). Ipak, na temelju njihove orijentacije, moguće ih je razdvojiti u dvije podfaze, mlađu i stariju. Mlađoj podfazi pripisani su grobovi koji prate orijentaciju ranogotičke crkve, ponajprije šest ukopa s kosturima sedam odraslih osoba (401, 403, 406, 410, 414, 415) jer su u grobu 414 zajedno ukopana dva odrasla pokojnika. U istu je podfazu smješten i jedan grob djeteta (399) te dva groba od kojih su sačuvane samo kosturnice (398 i 400). U tri groba utvrđeni su tragovi pougljenjenog drveta (406, 414, 415), a povremeno se javljaju i elementi, koji vjerojatno vuku korijene iz ranijeg razdoblja, ponajprije veće kamenje postavljeno uz rubove ukopa, a ustanovljeno u čak četiri groba smještena u ovu fazu (399, 401, 414 i 415).

widely distributed in the Carpathian Basin and especially common in the first half of the 11th century (see Giesler 1981: Taf. 4: 27, Taf. 53; Tomičić 1990: 88–89; Simoni 2004: 47, cat. 41, 6; Gáll 2013: 885–886, Pl. 312: 2a; Bojčić 2015: 31, cat. 6.9). A ring was also discovered in grave 416 (Fig. 5: B).²⁰ It is a closed band-shaped ring made from a thin silver sheet. Its edges are so messy that it seems as though it is unfinished.²¹

The deceased woman from grave 413 was probably also buried with silver S-circlets, but they did not stay *in situ*. Their fragments were discovered in the backfill of a grave assigned to the following burial phase (408) which cut the abovementioned grave.²² The analysis of characteristics of grave units and discovered finds situates the first burials in this area into the beginning of the 11th century. This is confirmed by the result of the radiocarbon dating of the sample from grave 417, as well as some results of the samples of the graves buried outside the sacristy (60, 61). They even leave the possibility of the burials beginning

20 The diameter of the ring is 15 to 16.2 mm, the hoop is 4.2–12.1 mm wide and 0.5 to 0.7 mm thick.

21 Among the finds from Bijelo Brdo, band-shaped rings are common, but they usually have separated and folded endings, and their surface is decorated with simple incisions (Demo 2009: 506–507, Fig. 43/1.2a–1.2b.).

22 The diameter of the best preserved circlet was probably 39 to 47 mm; the wire was around 2 mm thick.

Među nalazima iz ove faze ističe se brončana kopča nađena u grobu djeteta (399). Kopča ima ovalnu pređicu te sačuvanu iglu te pločicu s četiri kupolaste zakovice. Vanjska prečka pređice je zadebljana, rubovi su joj izvučeni prema van poput dva trokutasta roščića, a po sredini je ukrašena sa šest rebara (sl. 7). Geoff Egan i Frances Pritchard (2002: 76–78) ovaj tip kopče datiraju od kraja XII. do kraja XIV. stoljeća, a radiokarbonski datum dobiven na uzorku iz ovog groba, koji ga smješta između 1165. i 1260. godine, govori da je gorski primjerak među starijima, izrađen najkasnije sredinom XIII. stoljeća. Uz nju je nađena i petlja za držanje labavog dijela remena s unutarnjim izbočinama izrađena od istog materijala, a u literaturi se datira (Egan, Pritchard 2002: 229–235) jednako kao i kopča, s kojom je, očito, činila komplet.



Sl. 7 Kopča i petlja iz groba 399 (snimio: Janko Belaj)
Fig. 7 Buckle and loop from grave 399 (photo by: Janko Belaj)

Od ostalih nalaza ističe se brončani prsten trakastog presjeka ukrašen usporednim vodoravnim žljebovima koji po sredini čine izbočenu traku ili rebro (sl. 8).²³ Slično prstenje pronađeno je na mnogim kasnosrednjovjekovnim grobljima i karakteristično je za razdoblje od XIII. do XV. stoljeća (Petrinec 2005: 204; v. i Krznar 2012: 471). Prsten iz Gore potječe iz groba 401, a nađen je na prstu desne ruke pokojnika. Uz njegova stopala nađena je po jedna mala željezna kopča. Trapezoidna kopča²⁴ nađena je na rebrima pokojnice iz groba 403. Sva tri groba s nalazima pripadaju mlađoj podfazi druge faze ukopavanja, dok u starijim grobovima te faze nalazi nisu nađeni.

Naime u stariju podfazu ubrojani su nešto stariji grobovi koji još uvijek prate orijentaciju romaničke crkve i grobova prve faze ukopavanja. To su tri groba odraslih osoba (408, 412, 419) te grob fetusa (422). Riječ je o grobovima koji su presjekli grobove smještene u prvu fazu ukopavanja ili su ukopani neposredno iznad njih te koji ne poštuju raspored ukopa prethodne faze. U samo jednom od njih, grobu 408, uz ostatke pougljenjenog drveta, vjerojatno od

even somewhat earlier open. On the other hand, the duration of the first burial phase can be traced all the way to the arrival of the Knights Templar in the second half of the 12th century.

Phase 2

The thirteen graves in which the deceased individuals are still placed with their arms along the side of the body were assigned to the second burial phase (Fig. 16). However, based on their orientation, they can be separated into two sub-phases, one earlier and one later. The later sub-phase includes graves that are aligned with the early Gothic church; primarily six graves with skeletons of seven adults (401, 403, 406, 410, 414, 415), since two adult individuals were buried together in grave 414. The same sub-phase includes a child's grave (399) and two graves with reburied remains (398 and 400). Remains of charred wood were recorded in three graves (406, 414, 415), and the graves sometimes even included objects from the earlier period, primarily large stones placed along the edges of the graves, recorded in four graves from this phase (399, 401, 414, and 415).

A bronze buckle discovered in a child's grave (399) stands out among the finds from this phase. The buckle has an oval buckle ring, preserved tongue, and a plate with four dome-shaped rivets. The ring's outer bar is thickened, its edges are everted in the shape of two triangular horns, and it is decorated with six ribs in the centre (Fig. 7). Geoff Egan and Frances Pritchard (2002: 76–78) date this type of buckle to the period from the end of the 12th to the end of the 14th century, and the radiocarbon dating conducted on the sample from this grave places it between 1165 and 1260. Since it was produced no later than the mid-13th century, this buckle is one of the earlier ones from Gora. Alongside the buckle, a loop with protrusions on the inside made of the same material and used for holding the loose end of the belt strap, was discovered. Literature dates it to the same period as the buckle (Egan, Pritchard 2002: 229–235) with which, undoubtedly, the loop made a set.

The rest of the finds include a bronze ring with a band-shaped cross-section decorated with parallel horizontal grooves that make up a protruding band or a rib in the middle (Fig. 8).²³ Similar rings were discovered in many late medieval cemeteries and are characteristic of the period from the 13th to the 15th century (Petrinec 2005: 204; see Krznar 2012: 471). The Gora ring was discovered in grave 401, on the deceased individual's right-hand finger. One small iron clasp was discovered next to each of the individual's feet. A trapezoidal buckle²⁴ was discovered on the ribs of the deceased individual from grave 403. All three graves and their finds belong to the late sub-phase of the second burial phase, while the early graves of the same phase produced no finds.

²³ Prsten je promjera 23,4 do 23,5 mm, izrađen od trake širine 2,9 mm.

²⁴ Kopčice iz groba 401 i kopča iz groba 403 raspale su se tijekom procesa odsoljavanja u sklopu restauracije.

²³ The diameter of the ring is 23.4 to 23.5 mm. The band is 2.9 mm wide.

²⁴ Circllets from grave 401 and the buckle from grave 403 decomposed during the desalinization process of the restoration.



Sl. 8 Prsten trakastog presjeka nađen u grobu 401 (snimio: Janko Belaj)

Fig. 8 Ring with a band-shaped cross-section discovered in grave 401 (photo by: Janko Belaj)

lijesa, utvrđen je i veći kamen nađen uz tjeme pokojnice te veliki kamen iznad njenog desnog ramena, možda izvorno postavljen iznad lijesa. Kako je na uzorku kosti iz tog groba provedena radiokarbonska analiza, dobiveni datum smjestio ga je u relativno širok raspon između 1053. i 1220. godine. Ipak, s izrazitijom je vjerojatnošću smješten između 1156. i 1220. godine,²⁵ odnosno u period koji odgovara drugoj fazi ukopavanja. Kako dobiveni datum odgovara i datumu dobivenom na uzorku iz groba 399 koji je ukopan neposredno iznad njega, ali i drugim datumima dobivenim na uzorcima iz grobova ove faze pronađenima izvan sakristije, zajedno s grobovima 412, 419 i 422, pripisan je drugoj fazi ukopavanja. Naime, čini se da riječ o grobovima stanovnika ovog prostora ukopanim neposredno prije izgradnje nove crkve. Kako se čini da su pokojnici iz obje podfaze članovi istodobne zajednice, koja otprilike u zadnjoj četvrtini XII. stoljeća dolazi pod vlast templara, ovdje su zajedno razmatrani. S ovom fazom prestaje praksa oblaganje grobova kamenjem, lijesovi se počinju spajati čavlima,²⁶ a u zapunama grobova u idućim će se fazama nalaziti ulomci kasnosrednjovjekovne keramike, stakla i zgure. Možda se, pojednostavljeno, ovu fazu može nazvati „templarskom“ i pretpostaviti da završava odlaskom templara nakon ukidanja njihova reda 1312. godine.

Faza 3

Grobovi pripisani trećoj fazi ukopavanja prate orijentaciju ranogotičke crkve, pokojnicima su ruke i dalje položene uz tijelo, a nalazi i prilozi iznimno su rijetki. Pripisano joj je šest grobova s odraslim pokojnicima (377, 388, 390, 393,

25 Kalibrirani kalendarski datum (95,4 %) dobiven na uzorku iz groba 408 s 86,3 postotnom vjerojatnošću smješten je između 1156. i 1220. godine, a u period između 1053. i 1077 godine s vjerojatnošću od samo 9,1 %.

26 U grobovima istraživanima u Ivanovačkoj kapeli u Pakracu lijesovi su se i tijekom XIV. te prve polovice XV. stoljeća i dalje spajali drvenim moždanicima (Belaj et al. 2021).

The early sub-phase includes somewhat earlier graves that are still aligned with the orientation of the Romanesque church and the graves of the first burial phase. Those are three graves of adult individuals (408, 412, 419), and one grave of a foetus (422), which cut the graves attributed to the first burial phase or were buried directly above them, and they do not follow the burial layout of the previous phase. Only one of them, grave 408, next to the remains of charred wood, probably from a coffin, revealed a larger stone discovered next to the scalp of the deceased woman and a large stone above her right shoulder, perhaps placed above the coffin originally. The skeletal sample from the grave was sent to radiocarbon dating and the resulting date placed it to a relatively wide time-frame between 1053 and 1220. However, the more likely period is between 1156 and 1220,²⁵ i.e., the period that corresponds to the second burial phase. Since this date corresponds to the date obtained on the sample from grave 399 situated directly above it, but also to other dates obtained on samples from the graves of this phase discovered outside the sacristy, this grave was assigned to the second burial phase together with graves 412, 419, and 422. It seems that those are the graves of the inhabitants of this area buried just prior to the construction of the new church. Since it seems that the deceased individuals from both sub-phases were members of the contemporaneous community that came under the Knights Templar in the last quarter of the 12th century, they were analysed together. With this phase the practice of lining graves with stones ends, and in the following phases the use of nailed coffins begins,²⁶ while the backfills of the graves reveal fragments of late medieval pottery, glass and slag. Perhaps, for simplicity's sake, this phase can be called “a Templar phase” which seemingly ends with the Templars' departure after their order was dissolved in 1312.

Phase 3

Graves assigned to the third burial phase are of the same orientation as the early Gothic church, the deceased individuals' arms are still placed along the side of their body, while the finds and grave goods are extremely rare. Six graves with adult individuals (377, 388, 390, 393, 396, 407) were assigned to it, together with one grave containing only reburied remains (412B), graves of two adolescents (404, 411), and two children 4 to 6 years of age (391, 395) (Fig. 9).

Finds were recorded only in the two children's graves:²⁷ A small amorphous iron plate was discovered next to the

25 The calibrated radiocarbon date (95.4 %) for the sample from grave 408 was situated between 1156 and 1220 with 86.3% probability, while for the period between 1053 and 1077, the probability is only 9.1%.

26 Coffins from graves excavated in the Knights Hospitallers' chapel in Pakrac were still connected with wooden stud connectors in the 14th and the first half of the 15th century (Belaj et al. 2021).

27 The scarcity of the finds and especially the fact that no belt buckles were discovered in the graves were recorded in other cemeteries from the 14th century as well, for instance, at the Knights Hospitaller sites in Pakrac (Belaj et al. 2021) and Ivanec (Belaj, Sirovica 2021).

396, 407), jedan grob u kojem je sačuvana samo kosturnica (412B) te grobovi dvoje adolescenata (404, 411) i dvoje djece starosti 4 do 6 godina (391, 395) (sl. 9).

Nalazi su zabilježeni samo u grobovima dvoje djece:²⁷ Mala amorfnu željezna pločica pronađena je uz kosti stopala djeteta iz groba 395, dok je željezna aplikacija u obliku cvijeta sa šest do osam latica,²⁸ rupom u sredini i dvije zakovice, nađena na lubanji djeteta iz groba 391. Slične pri-

foot bones of the child from grave 395, while a flower-like sexfoil or octofoil iron mount²⁸ with a central hole and two rivets was discovered on the skull of the child from grave 391. Similar sixfoil mounts were presented by Egan and Pritchard (2002: 186, 189, Fig. 119: 950, 969, 990). They were discovered in London, where they entered everyday use in the mid-14th century and appeared throughout the 15th century (Egan, Pritchard 2002: 186). They were usually used

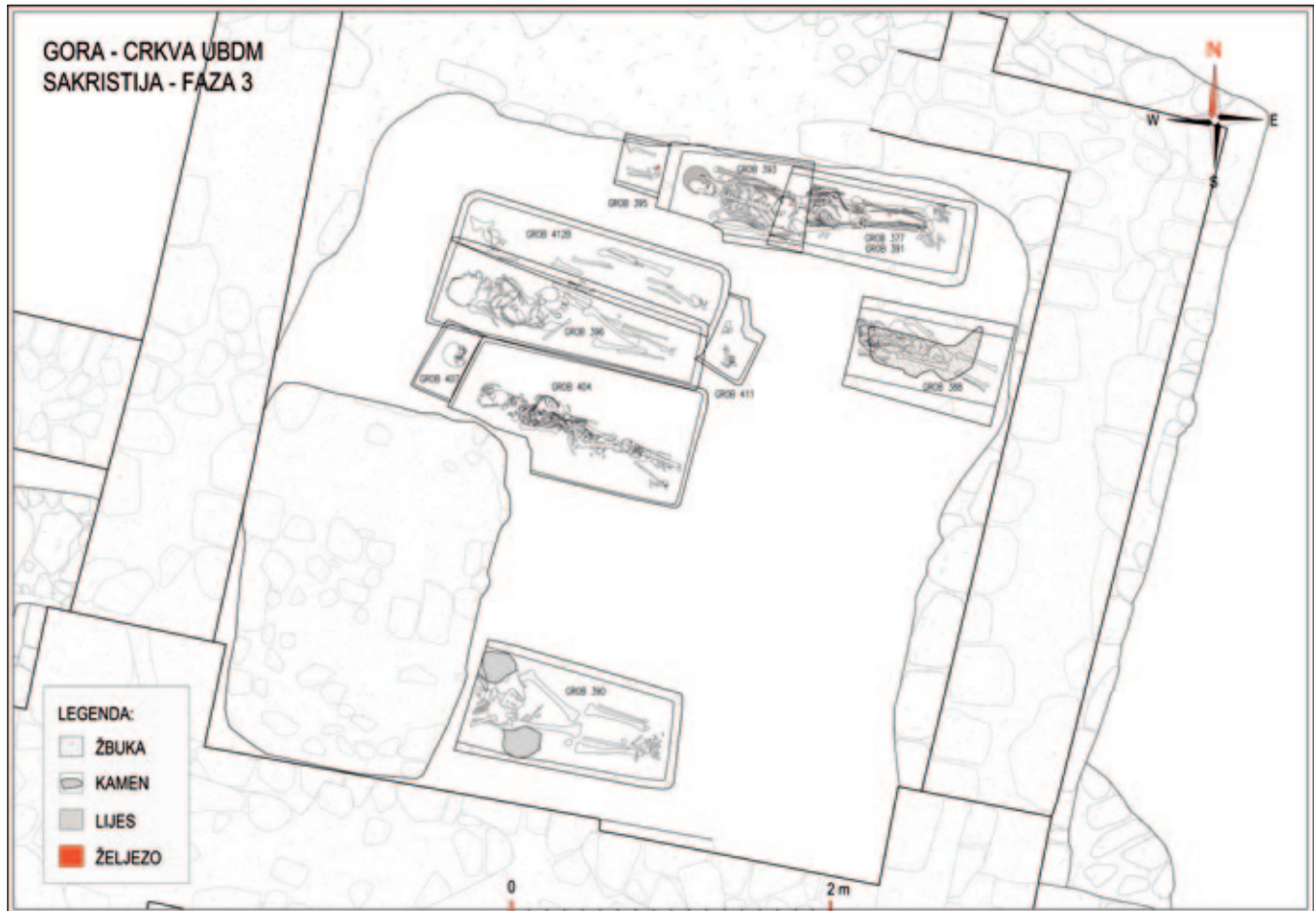

Sl. 9 Grobovi pripisani trećoj fazi ukopavanja (izradili: F. Sirovica, A. Kovačević, Arheoplan d.o.o.)

Fig. 9 Graves assigned to the third burial phase (made by: F. Sirovica, A. Kovačević, Arheoplan Ltd.)

mjerke sa šest latica donose Egan i Pritchard (2002: 186, 189, sl.119: 950, 969, 990). Nađene su Londonu gdje su u opću upotrebu ušle sredinom 14. stoljeća te se javljaju i kroz cijelo 15. stoljeće (Egan, Pritchard 2002: 186). Obično su se koriste kao dekoracija, no primjerci s većom rupom u sredini ponekad su korišteni kao ojačanje oko rupa za vezi- ce ili rupa na remenu kroz koje je prolazio trn kopče (Egan, Pritchard 2002: 162, 227–229, sl. 143). Jedini prilog nađen je u grobu muškarca srednje dobi (377), uz lijevu potkolje- nicu pokojnika. Riječ je o nožu od kojeg je sačuvan samo manji dio sječiva te djelomično očuvan trn drške na kojem

as a decoration, but the mounts with a larger central hole were sometimes used as surrounds for lace holes or for buckle-pin holes on belt strap (Egan, Pritchard 2002: 162, 227–229, Fig. 143). The only grave good was discovered in the grave of middle-adult male (377), next to his left shin. It was a knife from which only a small part of the blade was preserved, as well as a partly preserved tang with three visible holes for rivets which held the handle made of bone or wood (Fig. 10).

Coffin use was recorded again in the third burial phase, but a considerable number of nails also appear along their edges, alongside the traces of charred wood. In only one partially preserved grave (390) two larger stones around the pelvis and above the hands of the deceased individual were discovered. However, we cannot claim that

27 Malobrojnost nalaza, osobito činjenica da u grobovima nisu pronađene pojasne kopče, javlja se i drugdje na grobljima XIV. stoljeća, primjerice na ivanovačkim nalazištima u Pakracu (Belaj et al. 2021) i Ivancu (Belaj, Sirovica 2021).

28 Aplikacija je još uvijek na restauraciji i dok se ne ukloni korozija teško je odrediti njen specifičan tip.

28 The mount is still in the process of restoration and until the corrosion is removed, it is difficult to establish which type it belongs to.



Sl. 10 Djelomično očuvan nož iz groba 377 (snimio: H. Jambrek)
 Fig. 10 Partially preserved knife from grave 377 (photo by: H. Jambrek)

su vidljive tri rupice za zakovice kojima se pričvršćivala koštana ili drvena oplata (sl. 10).

U trećoj je fazi ukopavanja ponovo zabilježena upotreba lijesova, no uz tragove pougljenjenog drveta, sada se uz rubove ukopa javlja i veći broj čavala. U samo jednom djelomično sačuvanom grobu (390) nađena su dva veća kamena smještena oko zdjelice, a iznad šaka pokojnika. Ipak, nije moguće tvrditi da je riječ o namjernom postavljenom kamenju, nekoj vrsti kasne manifestacije običaja zabilježenog u ranijim fazama ukopavanja na ovome prostoru. Takve pretpostavke dodatno onemogućuju rezultati radiokarbonske analize koja je provedena na samo na ovom od 11 grobova smještenih u treću fazu ukopavanja. Iako je s jedne strane odabran zbog intenzivnijih stratigrafskih odnosa, a s druge zbog specifičnosti ukopa koji ima karakteristike ranijih faza ukopavanja, dobiveni datum smjestio ga je neočekivano kasno, između 1520. i 1653. godine, odnosno u slijedeću, četvrtu fazu ukopavanja. Kako stratigrafskom pozicijom i drugim značajkama odudara od grobova četvrte faze ukopavanja, prihvaćanjem mogućih pogrešaka pri odabiru, ekstrakciji ili obradi uzoraka, razmatran je u okviru treće faze ukopavanja. S druge strane, rezultat njegove radiokarbonske analize donekle je otežao definiranje njenog trajanja, no dobro definirani vremenski opseg prethodne, ali i slijedeće faze ukopavanja, smješta grobove treće faze u XIV. i možda početak XV. stoljeća.

Faza 4

Najmlađu fazu ukopavanja utvrđenu na prostoru kasnije izgrađene sakristije predstavljaju ponajprije grobovi stratigrafski utvrđeni kao najmlađi. Riječ je o grobovima dvoje odraslih osoba (374, 382) i dvoje djece (373, 378) koji su ustanovljeni nakon uklanjanja površinskih slojeva te ostataka mjestimično utvrđene, loše očuvane podloge za podnicu od žbuke i dijelova podnice od kamenja i opeke. U istu su fazu, uz jednu kosturnicu (373B), svrstani i nešto stariji, odnosno njima presječeni grobovi odraslih pokojnika (376, 379, 381, 383, 386, 387). Na temelju stratigrafskih

the stones were placed there intentionally as a form of late manifestation of a practice recorded in the earlier burial phases in this area. Assumptions such as this one are further disproved by the results of the radiocarbon dating which was conducted only on this grave, out of 11 graves assigned to the third burial phase. Although it was chosen due to its intensive stratigraphic relations and the specific style of burial with characteristics of the earlier burial phases, the result of the testing situated it unexpectedly late, between 1520 and 1653, i.e., in the next, fourth burial phase. Since its stratigraphic position and other characteristics do not correspond with the graves from the fourth burial phase, with the acceptance of possible errors in the selection, extraction or processing of sample, it was assigned to the third burial phase. On the other hand, the result of radiocarbon analysis made the determination of the third phase duration somewhat difficult, but the well-defined time-frames of the previous and following burial phases situate the graves of this phase into the 14th and perhaps the beginning of the 15th century.

Phase 4

The latest burial phase ascertained in the area where the sacristy was built includes primarily those graves that were identified as stratigraphically the latest. Those are graves of two adults (374, 382) and two subadults (373, 378), which were discovered beneath surface layer, the remains of sporadically recorded, poorly preserved pavement foundation made of plaster, and parts of the pavement made of stones and brick. The same phase, alongside one grave with reburied remains (373B), includes somewhat earlier graves, i.e., graves of adult individuals which were truncated by the abovementioned graves (376, 379, 381, 383, 386, 387). Based on stratigraphy, seven graves of subadults (375, 380, 384, 385, 389, 397, 402) were added to this phase, alongside two graves without chronologically indicative stratigraphic relations in which a foetus (392) and an infant (394) were buried (Fig. 11).

odnosa u ovu je fazu svrstano i sedam dječjih grobova (375, 380, 384, 385, 389, 397, 402) te dva groba bez kronološki indikativnih stratigrafskih odnosa u kojima su sahranjeni fetus (392) i dojenče (394) (sl. 11).

Riječ je o dječjim grobovima kakvi su utvrđeni i drugdje oko crkve, smješteni uz njene zidove ili blizu njih. Tim grobovima s jedne strane orijentacija ovisi o smjeru pružanja zidova crkve, dok ih s druge karakterizira manjak stratigrafskih odnosa, ali i drugih obilježja koja bi ih mogla jasnije kronološki definirati. Ipak, radiokarbonski datum dobiven na uzorku iz jednog od dječjih grobova (225) ukopanih uz istočni zid crkve smjestio je taj grob u raspon između 1437. i 1616. godine. Kako je i na drugim crkvenim grobljima primijećeno da je praksu sahranjivanja djece uz zidove crkve moguće vezati uz razdoblje novog vijeka (Tkalčec 2016: 165–166), grobovi 392 i 394, ukopani uz sjeverni zid svetišta, smješteni su u četvrtu fazu ukopavanja.

Odrasli pokojnici četvrte faze ukopavanja, kada je to bilo moguće utvrditi, ukopavaju se s rukama prekrženim na trbuhu, ili, u posebnoj varijanti, s jednom rukom svinutom u laktu i položenom na prsa, a drugom na trbuh. Isto je primijećeno i kod starije djece pripisane ovoj fazi ukopavanja te je samo dijete iz groba 385, starosti između 5 i 8 godina ukopano s rukama položenim uz tijelo. Ukopi prate smjer pružanja ranogotičke crkve povremeno uz manja odstupanja. Za dio pokojnika utvrđen je ukop u lijesu očuvanom

Such children's graves were recorded elsewhere around the church as well, alongside or near its walls. Orientation of those graves depends on the direction of the church's walls but is also characterized by the lack of stratigraphic relations and other characteristics that could define them more precisely chronologically. However, the radiocarbon date obtained for a sample from one of the children's graves (225) buried alongside the eastern wall of the church situated the grave in the period between 1437 and 1616. Like in other church cemeteries, it was noted that the practice of burying children along the walls of the church can be associated with the early modern period (Tkalčec 2016: 165–166). Therefore, graves 392 and 394, buried along the western wall of the sanctuary, were assigned to the fourth burial phase.

When it was possible to determine their position, adult deceased individuals from the fourth burial phase were recorded with their arms crossed on their stomachs, or, in a special variant, with one arm bent in the elbow and placed on the chest, and the other placed on the stomach. The same was noted in older children whose graves were assigned to this burial phase. Only the child from grave 385, 5 to 8 years of age, was buried with their arms extended along the body. The burials are aligned with the direction of the early Gothic church with some sporadic deviations.

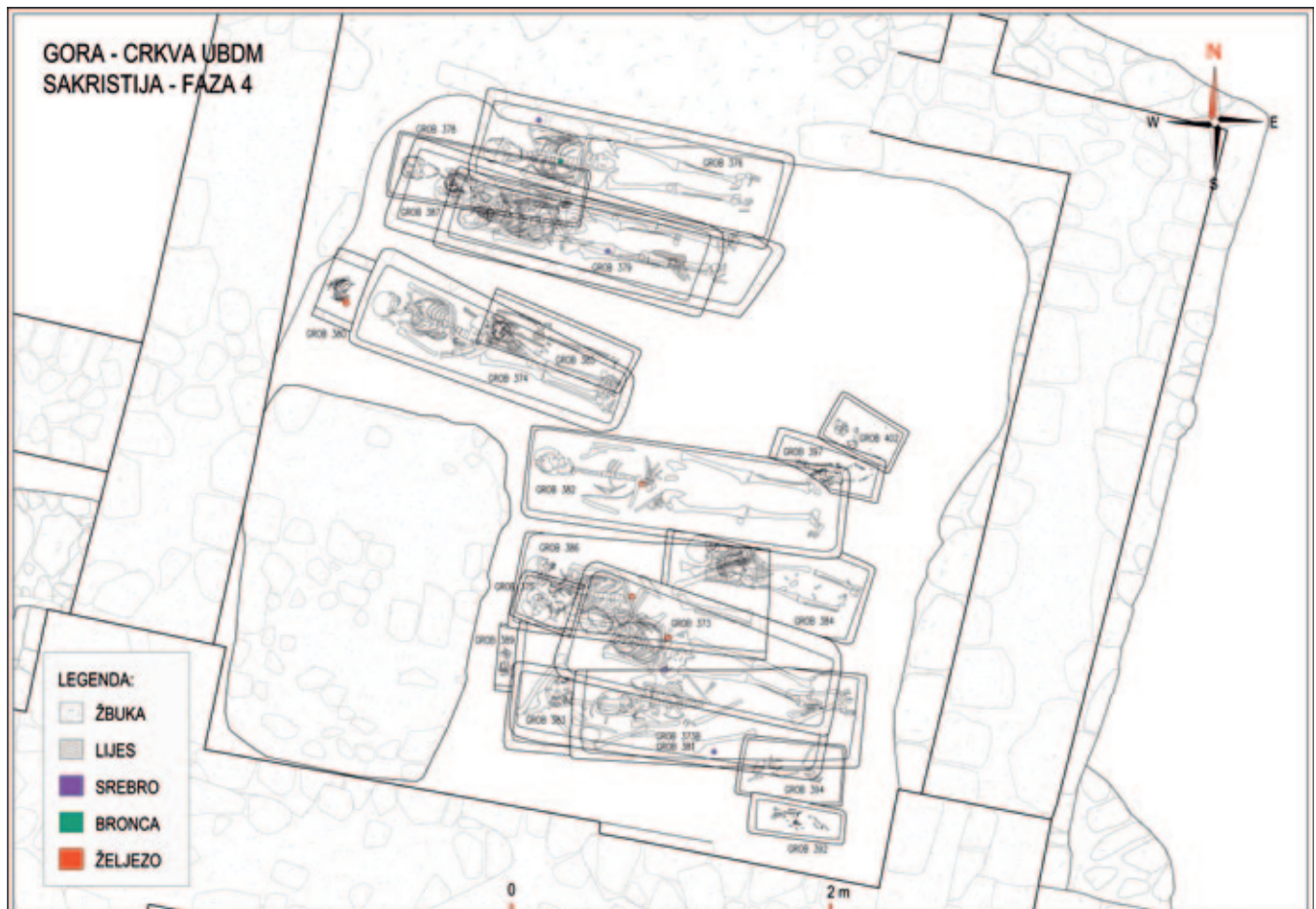

Sl. 11 Grobovi pripisani četvrtoj fazi ukopavanja (izradili: F. Sirovica, A. Kovačević, Arheoplan d.o.o.)

Fig. 11 Graves assigned to the fourth burial phase (made by: F. Sirovica, A. Kovačević, Arheoplan Ltd.)



Sl. 12 Željezne pojasne kopče četvrtastih okvira nađene u grobovima: A) 373; B) 382; C) 386; D) 380 (snimio: Janko Belaj)
 Fig. 12 Iron belt buckles with rectangular frames discovered in graves: A) 373; B) 382; C) 386; D) 380 (photo by: Janko Belaj)

u vidu pravilno raspoređenih čavala, često uz tragove poguljenjenog drveta.

Grobove četvrte faze karakterizira pojava željeznih pojasnih kopči četvrtastih okvira (sl. 12: A–D) kakve se najčešće javljaju tijekom XV. i XVI. stoljeća (Whitehead 1996: 16). U trima grobovima utvrđene su *in situ* (373, 382 i 386), dok je još jedna, djelomično očuvana, nađena u zapuni groba djeteta (380). Kopče su slične nalazima s Opatovine (Demo 2007: 75–77, kat. br. 16.10, 16.12) gdje su nalažene u grobovima iz XV. i prve polovine XVI. stoljeća (Demo 2007: 83).²⁹ Devet željeznih kopči četvrtastih okvira pronađeno je i u istraživanju groblja u Ivancu, sve su nađene u grobovima tamošnjeg drugog horizonta koji je datiran u XV. i prvu polovicu XVI. stoljeća.³⁰

Osim kopče nađene u zapuni, uz dijete iz groba 380 nađene su i dvije željezne aplikacije s kalotastom glavom i zakovicom (sl. 13). Slični su primjercima s Opatovine nađenim u grobovima 50 i 150 iz zadnje trećine XIV., odnosno prve trećine XV. stoljeća (Demo 2007: 73, bilj. 57). U kraj XIV. odnosno početak XV. stoljeća datirani su i brončani primjerci nađeni u Čepinu i Ivankovu (Krznar 2012: 256, 389, 466).

U čak četiri groba (373, 373B, 376 i 379) nađen je srebrni novac.³¹ U zapuni groba 379 nađen je pfennig kneževine Pfalz-Neuburg (sl. 14: A), kovani nepoznate godine u Neuburgu na Dunavu za vladavine Ottheinricha i Philippa (1505./1522. – 1535.), dok je među kostima kosturnice iz groba 373B nađen bečki pfennig četverokutnog oblika Fridrika III. Habsburga, koji se datira između 1457. i 1493. godine (sl. 14: B). Dva lošije očuvana pfenniga bavarskog vojvode Ernesta, kovana u Passauu između 1517. i 1540. godine, nađena

It was ascertained that some individuals were buried in a coffin, as testified by regularly placed nails, often with traces of charred wood.

The fourth burial phase graves are characterized by the appearance of iron belt buckles with rectangular frames (Fig. 12: A–D), as were most common in the 15th and 16th centuries (Whitehead 1996: 16). They were recorded *in situ* in three graves (373, 382, and 386), while one partially preserved buckle was discovered in the backfill of a child's grave (380). The buckles are similar to the ones discovered at Opatovina (Demo 2007: 75–77, cat. no. 16.10, 16.12) where they were found in graves from the 15th and the first half of the 16th century (Demo 2007: 83).²⁹ Nine iron buckles with rectangular frames were discovered during the excavation of the cemetery in Ivanec. All of them were found in graves belonging to the second horizon of the cemetery, dated to the 15th and the first half of the 16th century.³⁰

Aside from the buckle discovered in the backfill of the grave, two iron mounts with a hemispheric head and a rivet (Fig. 13) were discovered next to the child from grave 380. They are similar to the mounts from Opatovina discovered in graves 50 and 150 from the last third of the 14th and the first third of the 15th century (Demo 2007: 73, n. 57). Bronze mounts discovered in Čepin and Ivankovo were also dated to the end of the 14th and the beginning of the 15th century (Krznar 2012: 256, 389, 466).

Silver coins were discovered in four graves (373, 373B, 376, and 379).³¹ A pfennig from Palatinate-Neuburg (Fig. 14: A) was discovered in the backfill of grave 379. It was minted in Neuburg an der Donau during the reign of Otto Henry and Philipp (1505/1522–1535), but the exact year is unknown. A Frederick III's square Wiener pfennig (Fig. 14: B), dated between 1457 and 1493 was discovered among the reburied bones from grave 373B. Two poorly preserved Ernest of Bavaria's pfennings, minted in Passau between 1517 and 1540, were most probably discovered at the place of primary deposition. Coins were discovered among the left fist bones (Fig. 14: C) of the deceased individual in grave 373, while in grave 376, they were discovered next to the individual's left shoulder (Fig. 14: D). Since the reburied bones of previously deceased individuals were also discovered in the grave, we have to consider the possibility that this coin was placed there by accident. One of the latest graves in the sacristy, which was not cut by other graves, grave 373, the calibrated radiocarbon date places it to the period between 1475 and 1636. A similar but somewhat later date was obtained by analysing a sample from grave 386, with the belt buckle. It was dated by calibrated radiocarbon date in the range between 1514 and 1649. Since coins later than the 16th century were not discovered in the sacristy area, the comparison with the two radiocarbon dates obtained on samples from the graves of this phase

29 Kako sredinom XVI. stoljeća pokapanja na tom groblju prestaju, nije niti moglo biti kasnije datiranih nalaza.

30 Riječ je o grobovima 13, 16, 19, 20, 36, 75, 95, 102, 104 (Krznar 2012: 97, 111, 113–115, 128–129, 152–153, 168–169, 176–179). O kopčama, uključujući pitanje terminologije, v. i Burazer 2019.

31 U sklopu projekta „milOrd – Razvoj i naslijeđe viteških redova u Hrvatskoj“ (HRZZ, IP-2019-04-5513) u pripremi je rad o rezultatima analize novca pronađenog na lokalitetu.

29 Since there were no more burials at that cemetery after the mid-16th century, there could be no finds later than that.

30 Those are graves 13, 16, 19, 20, 36, 75, 95, 102, 104 (Krznar 2012: 97, 111, 113–115, 128–129, 152–153, 168–169, 176–179). On buckles, including terminology, see Burazer 2019.

31 A paper concerning the results of the analysis of the coins discovered at the site is being prepared within the project “milOrd – Development and Heritage of the Military Orders in Croatia” (HRZZ, IP-2019-04-5513).

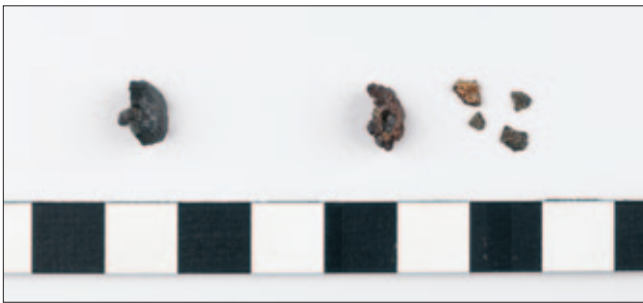

Sl. 13 Željezne aplike sa zakovicama iz groba 380 (snimio: Janko Belaj)
Fig. 13 Iron mounts with rivets from grave 380 (photo by: Janko Belaj)

su vrlo vjerojatno na mjestu primarne depozicije. U grobu 373 novac je nađen među kostima lijeve šake pokojnika (sl 14: C), dok je u grobu 376 nađen uz lijevo rame (sl 14: D). Kako su tu smještene i dislocirane kosti starijih pokojnika, ipak treba uzeti u obzir mogućnost da je novac na to mjesto dospio i slučajno. Istodobno, grob 373, kao jedan od najmlađih, ničim presječenih grobova istraženih u sakristiji, kalibrirani radiokarbonski datum smješta u razdoblje između 1475. i 1636. godine. Sličan, čak nešto kasniji datum, dobiven je analizom uzorka iz groba 386 s pojasnom kopčom. Kalibriran je u rasponu između 1514. i 1649. godine. Kako je primjetno da novac mlađi od XVI. stoljeća na prostoru sakristije nije pronađen, usporedba s dva radiokarbonska datuma dobivena na uzorcima iz grobova ove faze upućuje da je najkasnije početna desetljeća XVII. stoljeća moguće smatrati vremenom završetka ukopavanja na ovom prostoru, iako je ono moglo prestati i ranije.

indicates that in this area first decades of the 17th century can be considered the time of cessation of burial, although this could have happened a little earlier as well.

DISCUSSION: BURIAL PHASES IN THE CONTEXT OF TIME AND SPACE

The earliest graves discovered in the area around the Church of the Assumption of the Blessed Virgin Mary in Gora were marked by the finds of the so-called Bijelo Brdo culture, primarily by large S-circlets that probably belong to the period of the 11th or 12th century, when they were common across Central Europe and the Carpathian Basin. The cemetery with the first graves can be associated with the period when the earlier Romanesque church was used. Therefore, it is important to point out that historical sources do not mention the time it was built. Since the scarce immovable finds do not reveal much, certain spolia point to a possible dating of the church. The spolia were discovered during archaeological excavations and restoration work on deconstruction of the walls, and mostly include fragments of arch lintels decorated with palmette motifs. One of them was discovered in the northern wall of the church's nave (Belaj, Sirovica 2012: 59) and is similar to the two fragments discovered during previous excavations of this site (Miletić 1999: 144; Miletić, Valjato Fabris 2014: 57–58). Based on their analysis, Drago Miletić and Marija Valjato Fabris conclude, "...that a workshop with exceptionally skilful builders and stonemasons who built the Romanesque St. Mary's Church operated in continental Croatia as early as the 12th century" (Miletić, Valjato Fabris 2014: 57).



Sl. 14 Novac nađen u grobovima: A) 379; B) 373B; C) 373; D) 376 (snimio: Janko Belaj)
Fig. 14 Coins discovered in graves: A) 379; B) 373B; C) 373; D) 376 (photo by: Janko Belaj)

RASPRAVA: FAZE UKOPAVANJA U KONTEKSTU PROSTORA I VREMENA

Najstariji grobovi utvrđeni na prostoru oko Crkve Uznesenja Blažene Djevice Marije u Gori obilježeni su pojavom nalaza tzv. bjelobrdske kulture, ponajprije krupnim S-karičicama koje zajedno s prstenjem najvjerojatnije pripadaju XI. i XII. stoljeću i u tom su periodu česti nalazi diljem središnje Europe i Karpatske kotline. Groblje na kojem se ukopavaju prvi grobovi može se povezati s vremenom korištenja starije, romaničke crkve pa je u tom kontekstu bitno istaknuti da vrijeme njene izgradnje u povijesnim izvorima nije zabilježeno. Kako ni njeni neznatni nepokretni ostaci ne govore mnogo, na moguću dataciju upućuju pojedini *spoliji* otkriveni u arheološkim iskopavanjima i restauratorskim razgradnjama zidova, posebno ulomci lučnih nadvoja ukrašeni palmetama. Jedan od njih nađen je u sjevernome zidu broda crkve (Belaj, Sirovica 2012: 59) i sličan je dvama ulomcima nađenima u ranijim istraživanjima ovog nalazišta (Miletić 1999: 144; Miletić, Valjato Fabris 2014: 57–58). Na temelju njihove analize Drago Miletić i Marija Valjato Fabris zaključuju: „...da je u kontinentalnoj Hrvatskoj već tijekom 12. stoljeća djelovala radionica s iznimno kvalitetnim graditeljima i klesarima koji su sagradili romaničku crkvu sv. Marije“ (Miletić, Valjato Fabris 2014: 57).

S druge strane, rezultati radiokarbonskih analiza osteoloških ostataka govore da je ukopavanje na ovom prostoru počelo već početkom XI. stoljeća. Naime, na području sakristije najstariji radiokarbonski datum dobiven je na uzorku iz groba 417 koji je smješten u relativno širok raspon između 1030. i 1157. godine. Sličan datum potječe iz kosturnice označene kao grob 61, a ukopane uz potpornjak na južnome zidu crkve. U kosturnicu su bile uredno smještene kosti iz groba vjerojatno poremećenoga prigodom gradnje ranogotičke templarske crkve. Među kostima je pronađena prekrasna koštana kopča ukrašena dvama zrcalno postavljenim lavovima na okviru (Belaj, Sirovica 2012: 60–61, sl. 3). Dobiveni rezultat radiokarbonske analize primarni ukop groba ponovo datira relativno široko, između 994. i 1151. godine. S druge strane, najstariji datum, koji je smješten u uski raspon između 979. i 1035. godine, pružio je i uzorak iz, na žalost, donekle poremećenog groba 60. Utoliko je moguće da se groblje ovdje nalazilo i prije izgradnje crkve, ali i da je prva crkva na ovom mjestu mogla biti izgrađena čak cijelo stoljeće ranije. Time je otvorena mogućnost da razmatrani arhitektonski elementi potječu iz neke naknadne adaptacije romaničke crkve ili pak da je prije nje na istome mjestu postojala još starija crkva s pripadajućim grobljem. Dok drugu mogućnost razmatra i Krešimir Filipec (2015: 333–334), važno je istaknuti da se ukrašavanje palmetama na području sjeverne Italije javlja već početkom 11. stoljeća (Barral i Altet 2009: 68) pa Spomenka Jurić (2015: 70–71, bilj. 8), upozorava kako bi buduća istraživanja valjalo obratiti pozornost i na moguće utjecaje iz toga pravca u tom vremenu. Iako pitanje datacije romaničke crkve time nije riješeno, prvu fazu pokopavanja na ovom prostoru moguće je vremenski smjestiti od

On the other hand, the results of the radiocarbon analyses conducted on the skeletal remains indicate that burials in this area started at the beginning of the 11th century. The earliest radiocarbon date in the sacristy was obtained on sample from grave 417, which was situated in a relatively wide time frame, between 1030 and 1157. A similar date resulted from the analysis of the sample from grave 61 which contained reburied remains and was situated next to a buttress on the southern church wall. The grave included neatly placed bones from the grave probably disturbed during the construction of the early Gothic church. A beautiful bone buckle decorated with two mirroring lions on the frame was discovered among the bones (Belaj, Sirovica 2012: 60–61, Fig. 3). The results of the radiocarbon analysis situate the primary burial to a relatively wide time-frame, between 994 and 1151. On the other hand, the earliest date, between 979 and 1035, was obtained on sample from, unfortunately, the partly disturbed grave 60. Therefore, it is possible that there was a cemetery here before the church was constructed, but also that the first church on this position could have been built a whole century earlier. That opens the possibility that the above-mentioned architectural elements originate from a later adaptation of the Romanesque church or that an even earlier church with an adjoining cemetery was situated in its place. While the second possibility is considered by Krešimir Filipec (2015: 333–334), it is important to point out that in northern Italy, palmette decorations appear as early as the beginning of the 11th century (Barral and Altet 2009: 68) and Spomenka Jurić (2015: 70–71, note 8) stresses that future researches should pay attention to possible influences from that area at the time as well. Although this does not resolve the question of the time from which the Romanesque church originates, the first phase of burials in this area can be situated in the period from the beginning of the 11th century all the way to the time of the arrival of the Knights Templar during the second half of the 12th century.

The second phase probably begins with the arrival of the Knights Templar who built a new church in the place of the old Romanesque church. Although the reasons behind the demolition of the Romanesque church, which was obviously lavishly decorated, are unknown, the change in the orientation of the graves clearly indicates that the new church was constructed during this phase. The early Gothic Templar church is oriented more accurately in the east–west direction, with an 11–12° deviation towards the northeast–southwest. The church has a rectangular floorplan reminiscent of a military orders' hall, with the sanctuary in no way emphasized, not even in the height of the floor (Stošić 1994: 127). The clustered half-columns divide the surface area of the church into four equal bays with rib-groin vaults. Stepped buttresses made of large and regularly carved ashlar-stones are preserved on the church, and after it was blown up in 1992, preserved original half-columns with half capitals were revealed beneath the Baroque half columns, as well as other architectural elements of the early Gothic church (see more in: Miletić 1999: 137–139, 142–143).³²

32 The most valuable, Templar, stratum of the church was recently restored, with certain compromises (see more in: Miletić, Valjato Fabris, 2014). Unfor-

početka XI. stoljeća pa sve do vremena dolaska templara u ovaj posjed tijekom druge polovice XII. stoljeća.

Druga faza, dakle, vjerojatno započinje dolaskom templara koji na mjestu romaničke grade novu crkvu. Iako razlozi rušenja romaničke, očito raskošno opremljene crkve nisu poznati, promjena u orijentaciji pojedinih grobova jasno upućuje da se gradnja nove crkve dogodila tijekom ove faze. Naime, templarska ranogotička crkva relativno je pravilno orijentirana u smjeru istok–zapad, s otklonom od 11 – 12° prema smjeru sjeveroistok–jugozapad. Pravo-kutnog je tlocrta te, kako joj svetište ničim nije istaknuto, čak niti razinom poda, podsjeća na vitešku dvoranu (Stošić 1994: 127). Površina crkve svežnjastim je polustupovima podijeljena na četiri podjednaka traveja (jarma) te je bila presvođena križnorebrastim svodovima. Na crkvi su sačuvani stupnjevani, velikim i pravilnim klesancima zidani potpornjaci, a nakon miniranja crkve 1992. godine, ispod baroknih polustupova otkriveni su sačuvani i izvorni polustupovi s polukapitelima, kao i drugi arhitektonski elementi ranogotičke crkve (opširnije u Miletić 1999: 137–139, 142–143).³²

Tlocrt gorske crkve čest je u tipologiji arhitekture viteških redova. Najbliži je primjer po mnogo čemu slična i time vjerojatno istodobna ivanovačka kapela u Pakracu (Belaj, Papić 2021). Najbrojnije analogne primjere nalazimo na tlu današnje Francuske, gdje je podjednako zastupljen u sakralnoj arhitekturi i templara i ivanovaca, a većina ih se datira u drugu polovicu ili kraj XII. stoljeća (Belaj, Papić 2021). I mnogi drugi elementi arhitekture povezuju gorsku crkvu s ivanovačkom kapelom u Pakracu, ali i s nekim drugim crkvama, osobito viteških redova u sjevernoj, središnjoj i sjeveroistočnoj Francuskoj, no i s crkvama drugih redova na području srednjovjekovnog Ugarsko-Hrvatskog Kraljevstva (Belaj, Papić 2021), ali i današnje Slovenije (Dobronić 1984: 116). Ipak, vjerojatno je, kako u ivanovački Pakrac, tako i u templarsku Goru, ovaj tlocrtni tip uvezen direktno iz Francuske, bez posredovanja središta srednjovjekovnog Ugarsko-Hrvatskog Kraljevstva (opširnije u Belaj, Papić 2021). Točnu dataciju izgradnje ranogotičke templarske crkve povijesni izvori ponovno ne nude, no na nju upućuju rezultati arheoloških istraživanja i povijesnoumjetničkih analiza. Na temelju potonjih D. Miletić (1999: 149) isprva pretpostavlja da je do njene gradnje moglo doći već u prvim desetljećima XIII. stoljeća, no kasnije se odlučuje za prvu četvrtinu XIII. stoljeća (Miletić, Valjato Fabris 2014: 57). Predrag Marković i Krešimir Karlo (Marković, Karlo 2014: 583) gradnju također datiraju u prvu četvrtinu XIII. stoljeća.

Ipak, potrebno je osvrnuti se na ključni povijesni dokument i njegove dosadašnje interpretacije, naime na tvrdnju da je kralj Bela III. (1172. – 1196.) templarima darovao „trg“ (*forum*) za „rasvjetu“ crkve koja se nalazila u templar-

The Gora church floorplan is common in the typology of the military orders' architecture. Probably the most similar church to this one is the contemporaneous Knights Hospitaller chapel in Pakrac (Belaj, Papić 2021). The most numerous analogous churches can be found in present-day France, where this floorplan is as common in the Knight Templar as it is in the Knights Hospitaller sacral architecture. Most of them are dated to the second half or the end of the 12th century (Belaj, Papić 2021). There are multiple other architectural elements that link the church in Gora to the Knights Hospitaller chapel in Pakrac, but also with some other churches, especially the ones used by military orders in northern, central, and northeastern France, as well as the churches of other orders in the area of the medieval Croatian and Hungarian Kingdom (Belaj, Papić 2021) and present-day Slovenia (Dobronić 1984: 116). However, this type of floorplan was probably imported to the Knights Hospitaller's Pakrac and Templar Gora directly from France, without the mediation of the centre of the medieval Croatian and Hungarian Kingdom (for more, see Belaj, Papić 2021). Again, historical sources do not offer the exact date of the construction of the early Gothic Templar church, but it is indicated by the results of the archaeological research and analyses conducted by art historians. Based on the latter approach, D. Miletić (1999: 149) first assumed that the construction might have occurred in the first decades, but later he opted for the first quarter of the 13th century (Miletić, Valjato Fabris 2014: 57). Predrag Marković and Krešimir Karlo (Marković, Karlo 2014: 583) also dated the construction to the first quarter of the 13th century.

However, we have to take into consideration the key historical document, together with interpretations of it presented thus far. The document claims that King Bella III (1172–1196) granted a “market” (*forum*) for “the illumination” of the church in the Templars’ “court”.³³ The document in question was issued by King Andrew II in 1209 (Dobronić 2002: 32) and it states: *Forum eciam quod eis pater noster Bela rex beate memorie pro luminari ecclesie beate Marie, que sita est in curia ipsorum fratrum, dedit, sit in memoria ipsius et nostri stabile in eodem loco in sempiternum* (Smičiklas 1905: 85).³⁴ Željko Bartulović (2007: 278) believes that this means that the king granted the Knights Templar “the rights to or-

unately, the newly restored church in Gora was affected by the devastating earthquake that hit the Petrinja area on December 29, 2020. Since the whole region is vulnerable to earthquakes, D. Miletić (1999: 145, n.80) mentioned an earthquake as a potential cause of the demolition of the Romanesque church in Gora in the paper on the research conducted in 1997 and 1998.

33 Due to its titular, L. Dobronić believed that the same church was mentioned in the 1210 document by Andrew II in which the king, among other things, confirms the donation of land of considerable size “with St. Mary’s Church” that was given to the Knights Templars by Odola, a descendant of ban Borić (Dobronić 2002: 39). However, it seems that this is not the same church. Based on the distribution of ban Borić’s hereditary estates, Juraj Zelić (1998: 186) and Marija Karbić (Karbić 2005: 53–54) warned that it is more likely that the second mentioned “St. Mary’s Church” was situated near the present-day village of Ivandol, west of Požega (see also Mihaljević *et al.* 2018: 57–58).

34 “Likewise, let the market that was granted to them by our father King Bella in our blessed memory for the illumination of St. Mary’s Church, that is situated in the same brothers’ court, be in his and our memory permanently (constantly) on the same spot forever.” (Translated into Croatian by M. Karbić; Translated from Croatian into English by K. Deskar).

32 Nedavno je restituiran, uz par kompromisa, upravo najvrjedniji templarski sloj crkve (o tome opširnije u Miletić, Valjato Fabris, 2014). Na žalost, u razornom potresu koji je šire područje grada Petrinje pogodio 29. prosinca 2020. godine, izrazito je stradala i novoobnovljena crkva u Gori. Zbog podložnosti cijele regije potresima, D. Miletić (1999: 145, bilj. 80) već u objavi istraživanja provedenih 1997. i 1998. godine navodi potres kao mogući razlog rušenja romaničke crkve u Gori.

skom „dvoru“.³³ Riječ je o ispravi kralja Andrije II. iz 1209. godine (Dobronić 2002: 32) u kojoj se navodi: *Forum eciam quod eis pater noster Bela rex beate memorie pro luminari ecclesie beate Marie, que sita est in curia ipsorum fratrum, dedit, sit in memoria ipsius et nostri stabile in eodem loco in sempiternum* (Smičiklas 1905: 85).³⁴ Željko Bartulović (2007: 278) smatra da to znači da je kralj templarima „dodijelio prava na održavanje sajma i prikupljanje trgovačkih daća s njega“. U ispravi nije navedeno gdje se taj trg nalazio, no po redoslijedu nabiranja zemalja moguće je zaključiti da se nalazio u gorskoj županiji. Štoviše, Andrija II. će kasnije, 1213. godine, doista spomenuti „trg templara u Gori“ (Dobronić 2002: 36), prilikom čega će polovicu – očito nemale – pristojbe trga dodijeliti cistercitema iz Topuskog. Stoga se nameće pitanje jesu li izdaci za „rasvjetu“ crkve, odnosno „svijeće“ (Dobronić 1984: 74, 75) bili stvaran razlog toga čina i nisu li to bila prevelika sredstva za tako banalan trošak? Čini se da bi se iza termina *pro luminari* moglo „skrivati“ nešto drugo. Naime, iako se taj izraz često odnosi na održavanje crkve i podmirivanje dnevnih troškove bogoslužja, on može značiti i samu izgradnju crkve ili osnivanje zaklade neophodne za njenu izgradnju (van Hove 1913).³⁵ Postoji, dakle, indicija da je kralj Bela III. (su)financirao izgradnju gorske crkve još krajem XII. stoljeća.³⁶

Kao pomoć pri određivanju vremena izgradnje crkve može poslužiti i datum dobiven radiokarbonskom analizom kosti pokojnice iz groba 50. Ukop njenoga groba presjekao je rub kosturnice u kojoj je nađena koštana kopča (61) te rub ukopa za jedan od potpornjaka južnoga zida crkve. Ona je ukopana sa srebrnim prstenastim brošem na kojem se nalazi zavjetni natpis. Najsličniji primjerci ovome prstenastom brošu nađeni su u Francuskoj i datiraju se u XIII. stoljeće (Belaj, Belaj 2016: 257–258). Čini se vrlo vjerojatno da je žena iz groba 50, noseći broš sa zavjetnim natpisom, zajedno s templarima došla u Goru iz Francuske te da je pokopana nakon izgradnje crkve (Belaj, Belaj 2016: 268–269). Kalibrirani datum dobiveni radiokarbonskom analizom smješta ovaj ukop dosta široko, no najkasnije do 1213. godine.³⁷ Prema tomu, crkva je već ranije trebala biti izgrađena. To ne pobijaju ni radiokarbonski datumi dobiveni na uzorcima iz grobova 399 i 408 koji su istraženi

ganize fair and collect trade levies at them“. The document does not mention where the market was, but by the order in which the lands are mentioned it can be concluded that it was in the Gora County. Moreover, Andrew II would later, in 1213, really mention “the Knights Templar market in Gora” (Dobronić 2002: 36) and grant half of the – obviously considerable – market levy to the Cistercians in Topusko. Therefore, the question arises of whether the expenses for “the illumination” of the church, i.e., “the candles” (Dobronić 1984: 74, 75) were the real cause of the deed or was the amount too great for such a trivial expense? It seems that the term *pro luminari* might “conceal” something else. Although the term often refers to church maintenance and covering the everyday expenses of worship, it can also mean the construction of the church or establishing a fund for its construction (van Hove 1913).³⁵ Therefore, there are indications that King Bela III (co)financed the construction of the church in Gora in the late 12th century.³⁶

The date obtained by radiocarbon analysis of the bone sample of the deceased woman from grave 50 can also be of help in determining the time the church was constructed. Her grave cut the edge of the grave with reburial in which the bone buckle was discovered (61) and the edge of the truncation for one of the southern church wall buttresses. She was buried with a silver annular brooch with a votive inscription. Annular brooches most similar to this one were discovered in France and are dated to the 13th century (Belaj, Belaj 2016: 257–258). It seems probable that the woman from grave 50, wearing the brooch with a votive inscription, arrived with the Knights Templar to Gora from France and that she was buried after the church was constructed (Belaj, Belaj 2016: 268–269). The calibrated data acquired through radiocarbon analysis situates this grave into a fairly long period, but at the latest to 1213.³⁷ Therefore, the church should have already been built. This is not disputed by the radiocarbon dates obtained on samples from graves 399 and 408 that were excavated in the sacristy. They were buried one on top of the other, but have differed orientations, which pointed to the possibility of identifying two sub-phases within the second burial phase. Both of them belong to the period of Knights Templar rule, but probably to the time right before and right after the construction of the new church. This data confirms earlier assumptions (Dobronić 1984: 116) about the Knights Templar not waiting long to construct the new church after they acquired the estate in Gora. L. Dobronić (1984: 117) believed, for example, that due to “the pronouncedly round arch of the sacarium”, the architecture of the Gora church was “Romanesque, (...) in the style of the late 12th century with hints of the Gothic style”. It still remains unknown why they did not keep the Romanesque building, but their intention was perhaps symbolic as well: to present themselves and their distinctiveness in the

33 L. Dobronić smatrala je – zbog naslovnice – da se ista crkva spominje i u ispravi Andrije II. iz 1210. godine, kojom on, između ostaloga, potvrđuje darovanje povećane zemlje s „crkvom sv. Marije“ koju su templari dobili od Odole iz roda Borića bana (Dobronić 2002: 39). Ipak, čini se da se u ovom slučaju radi o drugoj crkvi! Juraj Zelić (1998: 186) i Marija Karbić (Karbić 2005: 53–54) upozorili su, temeljem rasprostranjenosti Borićevih nasljednih posjeda, kako je vjerojatnije da se drugospomenuta „crkva sv. Marije“ nalazila blizu današnjeg sela Ivandola, zapadno od Požege (v. i Mihaljević et al. 2018: 57–58).

34 „Također, neka trg koji je njima dao naš otac kralj Bela blažene uspomena za osvjetljenje crkve svete Marije, koja je smještena u dvoru iste braće, bude na njegovu i našu uspomenu postojano (trajno) u istom mjestu zauvijek.“ (Prijevod M. Karbić).

35 O terminu *pro luminari* v. u Katoličkoj enciklopediji iz 1913. pod natuknicom *Fabrica ecclesiae* (van Hove 1913).

36 To znači ranije nego što su cisterciti dobili svoje posjede u gorskoj županiji te započeli gradnju svoje, ipak mnogo velebnije, crkve sv. Marije u Topuskom.

37 Ipak, ne treba zanemariti mogućnost da će budući razvoj kalibracijskih postupaka ponuditi i drukčije datacije analiziranih uzoraka.

35 About the term *pro luminari*, see The Catholic Encyclopedia, 1913, entry *Fabrica ecclesiae* (van Hove 1913).

36 Therefore, before the Cistercians gained their estates in the Gora County and started the construction of their, quite larger, Church of St. Mary in Topusko.

37 However, we should not disregard the possibility that the development of calibration technology will offer different dates for the analysed samples.

ni na području sakristije. Ukopani jedan iznad drugoga s razlikom u orijentaciji ukazali su na mogućnost definiranja dvije podfaze u okviru druge faze ukopavanja gdje obje pripadaju periodu templarske uprave, no vjerojatno vremenu neposredno prije i zatim nakon izgradnje nove crkve. Navedeni podaci potvrđuju ranije iznesene pretpostavke (Dobronić 1984: 116) da templari nisu dugo čekali s izgradnjom nove crkve nakon što su dobili gorski posjed te je L. Dobronić (1984: 117) čak smatrala da je, primjerice, zbog „izrazito oblog luka sakrarija“ gorska arhitektura bila „romanička (...) kasnog 12. stoljeća s nagovještajem gotike“. I dalje ostaje nepoznato zašto nisu zadržali romaničku građevinu, no možda je njihova namjera sadržavala i simboličku komponentu: prezentirati se sredini u koju su došli u svoj svojoj posebnosti. Nešto slično su istovremeno učinili i ivanovci u Pakracu.

Dakle, druga faza pokopavanja počinje s dolaskom templara, a moguće je pretpostaviti da završava početkom XIV. stoljeća, odnosno smjenom templara ivanovcima, koji se u Gori, u dokumentima, javljaju već u ožujku 1314. godine (Dobronić 2002: 215; Karbić, Karbić 2021: 97). Sama smjena novim, po mnogočemu sličnim redom, vjerojatno ne bi izazvala velike promjene, da se nije poklopila s drugim promjenama u onodobnom društvu koje se – definitivnim krahom križarskih ideja – sve više odmiče od viteških ideala. Stoga je bitno istaknuti da je u vrijeme ivanovaca ovo bila župna crkva³⁸ te se u čuvenom popisu župa zagrebačke biskupije arhiđakona Ivana iz 1334. godine navodi na 40. mjestu kao „*ecclesia cruciferorum de Gora*“.³⁹

Teže je odrediti gornju granicu ove, treće faze, pogotovo jer je pitanje odlaska ivanovaca još uvijek nedovoljno rasvijetljeno. Nakon 1386. godine više se u dokumentima ne javljaju ivanovački preceptor Gore (Dobronić 2002: 219), no ivanovci su u Ugarsko-Hrvatskom Kraljevstvu ipak još neko vrijeme djelovali kao red nezavisan od sjedišta na Rodu, čije je priore birao kralj iz velikaških krugova (Engel 2001). Stoga, s oprezom, treću fazu možemo nazvati „ivanovačkom“, uz pretpostavku da obuhvaća i početak XV. stoljeća.

Na to upućuju i radiokarbonski datumi dobiveni na uzorcima kostiju iz grobova četvrte faze ukopavanja, ali i podaci dobiveni analizom prikupljenih nalaza, ponajprije novca i željeznih kopči. Oni početak ove faze ukopavanja vežu uz XV. stoljeće, prema svemu sudeći s odmakom od nekoliko desetljeća nakon njegovog početka. Dodatno, stratigrafski slijed i radiokarbonski datumi pokazuju da je period četvrte faze ukopavanja, ujedno i vrijeme kada crkvi biva prigraden zvonik na preslicu.⁴⁰ Naime, njegovom

community in which they arrived. The Knight Hospitallers did something similar at the same time in Pakrac.

Therefore, the second burial phase starts with the arrival of the Knights Templar and we can assume that it ends at the beginning of the 14th century, i.e., when the Knights Templar were replaced by the Knights Hospitallers, which, according to documents, appeared in Gora in March 1314 (Dobronić 2002: 215; Karbić, Karbić 2021: 97). The shift of the two, in many things similar, orders probably would not have caused great changes had it not coincided with other changes in society of the time which, with the decline of the Crusade idea, moved ever further away from the chivalric code. Therefore, it is important to point out that this was a parish church³⁸ during the Knights Hospitaller period and that it was mentioned as „*ecclesia cruciferorum de Gora*“ in the 40th entry of the Archdeacon Ivan's list of the parishes of the Diocese of Zagreb from 1334.³⁹

It is more difficult to establish the end of the third phase, especially because the question of the departure of the Knights Hospitaller is still not sufficiently clarified. After 1386, Hospitaller Gora preceptors do not appear in the documents anymore (Dobronić 2002: 219), but the Knights Hospitaller still operate for some time in the Croatian and Hungarian Kingdom as an order independent from their headquarters in Rhodes. Their priors were chosen from the members of nobility by the king (Engel 2001). Therefore, we can, with caution, call the third phase „the Knights Hospitaller phase“, assuming that it includes the beginning of the 15th century as well.

This is supported by the results of the radiocarbon dating obtained on the skeletal samples from the fourth burial phase graves, but also by the data acquired through the analysis of collected finds, primarily coins and iron buckles. They link the beginning of this burial phase to the 15th century, probably several decades after its beginning. In addition to that, the stratigraphic sequence and radiocarbon dates show that a bellcote was added to the church during the fourth burial phase.⁴⁰ The construction of the bellcote truncated multiple graves from various burial phases, and the radiocarbon dating conducted on the sample from grave 76, one of the stratigraphically latest graves, shows that it could have been buried during a longer time period, but not earlier than the second half of the 15th century.

On the other hand, the gathered data indicates that construction of the sacristy in 1705 should not be considered as a time when cessation of burial occurred in this area, and possible conclusion is that they cease at the end of the 16th century or at the beginning of the 17th century at the latest. Therefore, it can be assumed that the deceased individuals from this phase were buried in the period when

38 Ana Novak (2011: 152) smatra da je ova crkva bila župna već u doba templara.

39 Mnogi su istraživači na različite načine pokušali ubicirati čak četiri „gorske“ župne crkve iz tog popisa; te je pokušaje kritički prikazao D. Miletić, s čijom se konačnom identifikacijom ove crkve slažemo (Miletić 1999: 129–133, s opsežnom literaturom).

40 Iako D. Miletić (1999: 146), u prvoj objavi istraživanja crkve u Gori, vrijeme izgradnje zvonika na preslicu smješta u XV./XVI. st., u kasnijoj objavi zajedno s M. Valjato Fabris (Miletić, Valjato Fabris 2014: 57) pretpostavlja da je zvonik na preslicu sagrađen u ivanovačko vrijeme.

38 Ana Novak (2011: 152) believes that this church was already a parish church in the Knights Templar period.

39 Many scholars tried to locate the four „Gora“ parish churches from the list in various ways; their attempts were critically presented by D. Miletić, with whose final identification of the church we agree (Miletić 1999: 129–133, including a vast literature list).

40 Although D. Miletić (1999: 146) situates the construction of the bellcote to the 15th/16th century in his first paper about the excavations in Gora, in a later publication with M. Valjato Fabris (Miletić, Valjato Fabris 2014: 57), he assumes that the bellcote was constructed in the Knights Hospitaller period.

gradnjom presječeno je više grobova iz različitih faza ukopavanja, a radiokarbonska analiza uzorka iz groba 76, jednog od stratigrafski najmlađih među njima, pokazuje da je mogao biti ukopan u širokom vremenskom rasponu, no ne ranije od druge polovice XV. stoljeća.

S druge strane, prikupljeni podaci upućuju da kao gornju granicu pokopavanja na prostoru sakristije ne treba gledati njenu izgradnju 1705. godine, već je moguće zaključiti da ono završava krajem XVI., odnosno najkasnije početkom XVII. stoljeća. Prema tome, moguće je pretpostaviti da su pokojnici ove faze pokopavani u vrijeme kada „pravih“ vitezova ivanovaca više nije bilo u Gori, pa sve do vremena kada ovaj prostor zauzimaju Osmanlije ili najkasnije tijekom prvih desetljeća njihove vladavine. Razlozi prestanka ukopavanja nisu još sasvim jasni te je moguće da se ni drugdje oko crkve nije pokopavalo tijekom tog perioda, ali i da je, primjerice, prostor na kojem je kasnije sagrađena sakristija u ovom periodu zatrpan urušenjem. Naime, tijekom osmanlijske vladavine, od 1592. pa sve do 1702. godine, u Gori se nije nalazilo sjedište župe, te je vjerojatno crkva u tom periodu djelomično srušena, ili je čak cijela crkvena građevina tada postala ruševna i bez krova (Miletić 1999: 136). Na temelju kanonske vizitacije iz 1702. godine, Đurđica Cvitanović (1971: 151, bilj. 5) navodi da je nakon oslobođenja Gore od Osmanlija uz srednjovjekovnu zidanu crkvu „koja je zatečena u ruševnom stanju“ privremeno podignuta mala drvena kapela. U prilog lošem stanju crkvene građevine govore i podaci o kasnijoj obnovi crkve, ponajprije onoj iz 1705. godine kada su popravljani zidovi i posebno urušeni svod te joj je dograđena sakristija (Cvitanović 1971: 151), ali i nužnoj punoj obnovi koja se odvijala između 1726. i 1736. godine (Cvitanović 1971: 152; Miletić 1999: 146–147).

ZAKLJUČAK

Kako bi se stekla podloga za analizu i interpretaciju podataka i pokretnog arheološkog materijala prikupljenog tijekom arheoloških istraživanja provedenih oko crkve Uznesenja Blažene Djevice Marije u Gori, ukopi pokojnika sahranjivanih na području kasnije izgrađene sakristije podijeljeni su u četiri faze ukopavanja. To je bilo moguće učiniti tek primjenom metoda različitih disciplina i analizom njihovih rezultata. Stoga je prikazani postupak utemeljen na analizi utvrđenog stratigrafskog slijeda arheološki proučavanog prostora, a zatim nadopunjen i po potrebi korigiran rezultatima analize nalaza pronađenih u grobovima i njihovim zapunama te pojedinih grobnih obilježja poput njihove orijentacije i položaja ruku pokojnika te prisutnosti čavala, kamenih obloga ili tek ponekog kamena uz pokojnika. Konačno, uz pomoć rezultata radiokarbonskih analiza odabranih uzoraka pobliže je definiran raspon trajanja pojedinih faza ukopavanja te su prva ukopavanja na promatranom području smještena u početak XI. stoljeća, a trajanje ukopavanja moguće je pratiti sve do kraja XVI. ili početka XVII. stoljeća.

there were no more the “real” Knights Hospitaller in Gora, all the way to the period when this area was conquered by the Ottomans or during the first decades of their rule at the latest. The reasons behind the cessation of the burials are still not completely clear. It is possible that there were no burials in other areas around the church in this period either, but also that, for instance, the area where the sacristy was subsequently constructed was buried under rubble. The centre of the parish was not in Gora during the Ottoman rule, between 1592 and 1702, and the church was probably partially demolished, or, perhaps, the whole church became dilapidated and had no roof (Miletić 1999: 136). Based on the 1702 canonical visitation, Đurđica Cvitanović (1971: 151, n. 5) states that a small temporary wooden chapel was erected next to the medieval masonry church “that was found in a dilapidated state” after Gora was reconquered from the Ottomans. The poor condition of the church structure is supported by the data about the later reconstructions of the church, primarily the 1705 reconstruction when the walls and the collapsed vault were repaired and the sacristy was constructed (Cvitanović 1971: 151), but also the necessary complete renovation that was conducted between 1726 and 1736 (Cvitanović 1971: 152; Miletić 1999: 146–147).

CONCLUSION

Burials of the deceased individuals in the area where the sacristy was later built were divided into four burial phases for the purposes of the analysis and the interpretation of data and archaeological artefacts collected during the archaeological excavation in the area around the Church of the Assumption of the Blessed Virgin Mary in Gora. That was possible only after the methods from various disciplines were applied and their results were analysed. Therefore, the presented process was based on the analysis of the determined stratigraphic sequence of the archaeologically studied area. Consequently, it was complemented and, where it was necessary, amended according to the results of the analysis of finds discovered in the graves and their backfills, and analysis of grave features, such as their orientation and the position of the deceaseds' arms, the presence of nails, stone linings, or a single stones next to a deceased. Finally, the durations of burial phases were more precisely defined with the help of the results of the radiocarbon dating of chosen samples. The first burials in this area were conducted at the beginning of the 11th century and the duration of the burial practice can be traced to the end of the 16th or the beginning of the 17th century.

Naturally, some questions could not have been adequately answered. For instance, we do not know the reason behind the demolition of the Romanesque church which preceded the Templar church, when exactly it was built, and even whether it was the only earlier church at this site. The questions regarding the exact time of the construction of the Knights Templar church and more precise dating of certain interventions which changed its appearance also remain unanswered. However, analyses conducted in the realm of art history and interpretations of available

Naravno da neka pitanja niti ovim radom nisu mogla biti u potpunosti riješena, poput razloga rušenja romaničke crkve koja je prethodila templarskoj, točnije datacije njene izgradnje pa čak i dvojbe je li ona bila jedina starija crkva na ovome lokalitetu. Otvorena ostaju i pitanja vezana uz točno vrijeme izgradnje templarske crkve te preciznije datiranje pojedinih graditeljskih intervencija koje su mijenjale njezin izgled. Ipak, povijesnoumjetničke analize te interpretacije dostupnih povijesnih izvora pružile su mogućnost povezivanja utvrđenih faza ukopavanja grobova s graditeljskim fazama utvrđenim na nalazištu te pojedinim povijesnim okolnostima u kojima su se te aktivnosti odvijale. To je omogućilo jasnije razumijevanje pojedinih faza korištenja ovog prostora i time definiranje vremena predtemplarske zajednice, onog templara i potom ivanovaca, te vrijeme kada Gora bez „pravih“ vitezova dočekuje Osmanlije.

historical sources allowed the association of the identified burial phases with the construction phases recorded at the site and some historical circumstances in which those activities took place. That enabled a better understanding of certain phases in which this site was used and thus the determination of the periods of the pre-Templar community, the Templar and Hospitaller periods, and the period when Gora, without “real” military orders, was conquered by the Ottomans.

Prijevod i lektura / Translation and proofreading
Kristina Deskar

LITERATURA / BIBLIOGRAPHY

- Azinović Bebek, A., Pleše T. 2004, Gora, župna crkva Uznesenja Blažene Djevice Marije, *Obavijesti Hrvatskog arheološkog društva*, Vol. XXXVI(1), 146–155.
- Barral i Atlet, X. 2009, *Protiv romanike? Esej o pronađenoj prošlosti*, Institut za povijest umjetnosti, Zagreb.
- Bartulović, Ž. 2007, Neka pitanja iz povijesti Senja, *Senjski zbornik*, Vol. 34, 265–296.
- Bedić, Ž., Belaj, J., Sirovica, F. 2022, Bioarheološka studija populacije iz Gore kraj Petrinje, Hrvatska, *Prilozi instituta za arheologiju u Zagrebu*, Vol. 39(1) (in press).
- Bekić, L. 2016, *Rani srednji vijek između Panonije i Jadrana. Ranoslavenski keramički i ostali arheološki nalazi od 6. do 8. stoljeća / The early medieval between Pannonia and the Adriatic. Early Slavic ceramic and other archaeological finds from the sixth to eighth century*, Monografije i katalozi 27, Arheološki muzej Istre, Pula.
- Belaj, J. 2011, Prikaz arheoloških istraživanja crkve Uznesenja Blažene Djevice Marije u Gori tijekom 2008. i 2009. godine, in: *Antiquam fidem. Zbornik radova sa znanstvenog skupa o Sisačkoj biskupiji*, Sisak, 3.–4. prosinca 2010., Tepert D., Jurić S. (eds.), Sisačka Biskupija – Glas Koncila, Zagreb, 121–147.
- Belaj, J., Belaj, M. 2016, Prstenasti broš s natpisom iz templarske Gore – prijedlog dekodiranja / An Inscribed Annular Brooch from the Templar Site of Gora – A Possible Decipherment, *Prilozi instituta za arheologiju u Zagrebu*, Vol. 33, 247–270.
- Belaj, J., Papić, I. 2021, Ivanovačka kapela u Pakracu – prikaz graditeljskog razvoja, *Vjesnik Arheološkog muzeja u Zagrebu*, Vol. 54 (in press).
- Belaj, J., Sirovica, F. 2012, Arheološka istraživanja crkve Uznesenja Blažene Djevice Marije u Gori od 2008. do 2011. godine, *Annales Instituti Archaeologici*, Vol. VIII, 58–62.
- Belaj, J., Sirovica, F. 2016, Kamenom obloženi grobovi na nalazištu Ivanec – Stari grad, in: *Groblja i pogrebni običaji u srednjem i ranom novom vijeku na prostoru sjeverne Hrvatske*, Zbornik radova prvog međunarodnog znanstvenog skupa srednjovjekovne arheologije Instituta za arheologiju, Zagreb, 4. lipnja 2014., Krznar S., Sekelj Ivančan T., Tkalčec T., Belaj J. (eds.), Zbornik Instituta za arheologiju 4, Institut za arheologiju, Zagreb, 57–73.
- Belaj, J., Sirovica, F. 2021, The Disappearance of Grave Goods: Changes in Burial Practices in 14th Century Ivanec, Croatia, in: *Homines, Funera, Astra, fourth edition: Time and Cause of Death from Prehistory to Middle Ages*, International Symposium on Funerary Anthropology, Alba Iulia, September 21 – 23, 2014 (in press).
- Belaj, J., Stingl, S., Gligora, V. 2021, O arheološkim istraživanjima ivanovačke kapele na lokalitetu Pakrac – Stari grad 2019. godine, *Annales Instituti Archaeologici*, Vol. XVI, 122–134.
- Bojčić, Z. 2015, *Zlato i srebro srednjeg vijeka u Muzeju Slavonije*, Muzej Slavonije, Osijek.
- Burazer, B. 2019, *Arheološki nalazi kopča od 12. do 17. stoljeća u Hrvatskoj*, Unpublished MA Thesis, Sveučilište u Zadru, Zadar.
- Cvitanović, Đ. 1971, Gorska župa i župna crkva Blažene Djevice Marije, *Peristil*, Vol. 14–15 (1971–1972), 151–162.
- Demo, Ž. 2007, *Opatovina – tragovi povijesti izgubljene u sadašnjosti. Rezultati arheoloških iskopavanja pred crkvom svetog Franje u Zagrebu 2001. godine*, Arheološki muzej u Zagrebu, Zagreb.
- Demo, Ž. 2009, *Ranosrednjovjekovno groblje bjelobrdske kulture: Vukovar – Lijeva Bara (X–XI. stoljeće)*, Katalozi i monografije VI/1–2, Arheološki muzej u Zagrebu, Zagreb.
- Demo, Ž. 2013, Nekoliko misli i opažanja o pogrebnim običajima i pokapanju na groblju Drinovci-Greblje, in: *Kultovi, mitovi i vjerovanja u Zagori*, Zbornik radova sa znanstvenog skupa, Unešić, 14. prosinca 2012, Kapitanović V. (ed.), Kulturni sabor Zagore – Odsjek za povijest Sveučilišta u Splitu – Veučilište u Šibeniku, Split, 109–124.
- Demo, Ž. 2014, *Zlato i srebro srednjeg vijeka u Arheološkom muzeju u Zagrebu*, Arheološki muzej u Zagrebu, Zagreb.
- Dobronić, L. 1984, *Posjedi i sjedišta templara, ivanovaca i sepulkralaca u Hrvatskoj*, Rad Jugoslavenske akademije znanosti i umjetnosti knjiga 406, Razred za likovne umjetnosti knjiga XI, Zagreb.
- Dobronić, L. 2002, *Templari i ivanovci u Hrvatskoj*, Dom i svijet, Zagreb.
- Egan, G., Pritchard, F. 2002, *Dress Accessories 1150–1450. Medieval finds from excavations in London 3*, Boydell Press, Woodbridge.
- Engel, P. 2001, The Estates of the Hospitaller Priory of Vrana, in: *The Crusades and the Military Orders. Expanding the Frontiers of Medieval Latin Christianity*, Hunyadi Zs., Laszlovszky J. (eds), Department of Medieval Studies of the Central European University, Budapest, 291–301.
- Ercegović-Pavlović, S. 1980, Les nécropoles romaines et médiévales de Mačvanska Mitrovica / Мацванска Митровица. Некрополе, in: Sirmium XII. Recherches Archéologiques en Syrmie, Popović V. (ed.), Arheološki institut, Beograd.
- Filipec, K. 2012, *Srednjovjekovno groblje i naselje Đakovo – Župna crkva*, Odsjek za arheologiju Filozofskog fakulteta, Zagreb.
- Filipec, K. 2015, *Donja Panonija od 9. do 11. stoljeća*, Univerzitet u Sarajevu, Sarajevo.
- Gáll, E. 2013, *Az Erdélyi-medence, a Partium és a Bánság 10–11. századi temetői, szórvány- és kincsletelei (10th and 11th century Burial sites, Stray finds and Treasures in the Transylvanian Basin, the Partium and the Banat)*, Szegedi Tudományegyetem Régészeti Tanszéke – Magyar Nemzeti Múzeum – Magyar Tudományos Akadémia Bölcsészettudományi Kutatóközpont Régészeti Intézet, Szeged – Budapest.
- Giesler, J. 1981, Untersuchungen zur Chronologie der Bijelo Brdo-Kultur. Ein Beitrag zur Archäologie des 10. und 11. Jahrhunderts im Karpatenbecken, *Praehistorische Zeitschrift*, Vol. 56(1), 4–167. <https://doi.org/10.1515/prhz.1981.56.1.3>
- Jurić, S. 2017, Ecclesia Beatae Virginis de Gorra – pitanje kontinuiteta Siscijanske biskupije, in: *Štovanje Bogorodice na području Sisačke biskupije*, Zbornik radova mariološko-marijanskog simpozija povodom šeste obljetnice ponovne uspostave Sisačke biskupije, Sisak, 4.–6. prosinca 2015., Kovač V. N. (ed.), Katolički bogoslovni fakultet – Kršćanska sadašnjost, Zagreb, 67–82.
- Karbić, D., Karbić, M. 2021, Templari u Ugarsko-Hrvatskom Kraljevstvu, in: *Povijest templara na hrvatskim prostorima*, Karbić D., Karbić M. (eds.), Hrvatski viteški red templara – Ordo Supremus Militaris Templi Hierosolymitani Veliki priorat, Zagreb, 61–104.
- Karbić, M. 2005, Posjedi plemićkog roda Borića bana do sredine XIV. stoljeća, *Scrinia Slavonica*, Vol. 5, 48–61.
- Knezović, I., Pintarić, T. 2006, *Muzej Turopolja. Arheologija*, katalog, Muzej Turopolja, Velika Gorica.
- Krznar, S. 2012, *Arheološka slika kasnosrednjovjekovnih groblja na prostoru sjeverne Hrvatske*, Unpublished PhD Thesis, University of Zagreb, Zagreb.
- Marković, P., Karlo, K. 2014, Religious Architecture of the military Orders in Medieval Slavonia and its Reflections in the 13th and 14th Century, *Hortus artium medievalium*, Vol. 20(2), 579–589.
- Mihaljević, M., Matković, M., Horvat, Z. 2018, Arheološka istraživanja lokaliteta Njive-Ivandol – kao prilog poznavanju srednjovjekovlja požske kotline, *Radovi Zavoda za znanstveni i umjetnički rad u Požegi*, Vol. 7, 55–90.
- Miletić, D. 1999, Župna crkva Uznesenja B. D. Marije u Gori, *Godišnjak zaštitite spomenika kulture Hrvatske*, Vol. 22–23 (1996–1997), 127–151.
- Miletić, D., Valjato Fabris, M. 2014, Rekonstrukcija templarskog sloja župne crkve Uznesenja Blažene Djevice Marije u Gori, *Portal*, Vol. 5, 49–70.
- Molnár, M. 2020, *AMS 14C Analyses Report (Project code: I/2592)*, HEKAL AMS Laboratory, ISOTOPTech-ATOMKI, Debrecen (unpublished report, stored at the Institute of Archeology, Zagreb).
- Novak, A. 2011, *Gorski arhidakonat Zagrebačke biskupije u razdoblju od 1334. do 1501. godine (Povijesni razvoj crkvenoadministrativnoga područja)*, Unpublished PhD Thesis, University of Zagreb, Zagreb.
- Petrinec, M. 2005, Dva starohrvatska groblja u Biskupiji kod Knina, *Vjesnik za arheologiju i povijest dalmatinsku*, Vol. 98, 171–212.
- Simoni, K. 2004, *Stenjevec. Starohrvatsko groblje*, Arheološki muzej u Zagrebu, Zagreb.
- Smičiklas, T. 1905, *Codex diplomaticus regni Croatiae, Dalmatiae et Slavoniae, volumen III., diplomata annorum 1201–1235. continens / Diplomatički zbornik kraljevine Hrvatske, Dalmacije i Slavonije, svezak III., Listine godina 1201–1235*, Jugoslavenska akademija znanosti i umjetnosti, Zagreb.
- Stošić, J. 1994, Srednjovjekovna umjetnička svjedočanstva o zagrebačkoj biskupiji, in: *Sveti trag. Devetsto godina umjetnosti zagrebačke nadbiskupije 1094.-1994.*, katalog izložbe, Lukšić T., Reberski I. (eds.), Muzejsko-galerijski centar – Institut za povijest umjetnosti – Zagrebačka nadbiskupija, Zagreb, 101–130.

Tkalčec, T. 2016, Odabir mjesta za pokop djece u novom vijeku na primjeru Crkvara kod Orahovice, in: *Groblja i pogrebni običaji u srednjem i ranom novom vijeku na prostoru sjeverne Hrvatske*, Zbornik radova prvog međunarodnog znanstvenog skupa srednjovjekovne arheologije Instituta za arheologiju, Zagreb, 4. lipnja 2014., Krznar S., Sekelj Ivančan T., Tkalčec T., Belaj J. (eds.), Zbornik Instituta za arheologiju 4, Institut za arheologiju, Zagreb, 161–201.

Tomičić, Ž. 1990, Tragom novijih istraživanja Bjelobrdске kulture u slavonskom dijelu Podravine, Prilozi Instituta za arheologiju u Zagrebu, Vol. 7, 85–105.

van Hove, A. 1913, Fabrica Ecclesiae, Catholic Encyclopedia, Volume 5 [https://en.wikisource.org/wiki/Catholic_Encyclopedia_\(1913\)/Fabrica_Ecclesi%C3%A6](https://en.wikisource.org/wiki/Catholic_Encyclopedia_(1913)/Fabrica_Ecclesi%C3%A6) (30. 12. 2020).

Whitehead, R. 1996, Buckles. 1250-1800, Greenlight Publishing, Witham.
Zelić, J. 1998, Kamengrad u kamenskom kraju, Zlatna dolina, Vol. 4(1), 183–198.